



Belt-alignment switch ZS 91 SR -40°C ... +85°C IP66 Extreme

Features/Options

- Temperature-proof from -40 °C to +85 °C
- High degree of protection IP 66 / IP 67
- Thermoplastic enclosure
- 4 or 6 contacts

- 4 contacts with contact staggering available:
 - 1 NC and 1 NO contact switching at 15°
 - 1 NC and 1 NO contact switching at 25°
- Release by lever (VD) possible
- Belt-alignment lever continuously adjustable
- Version with Dupline or Dupline Safe available on request

Dimensions

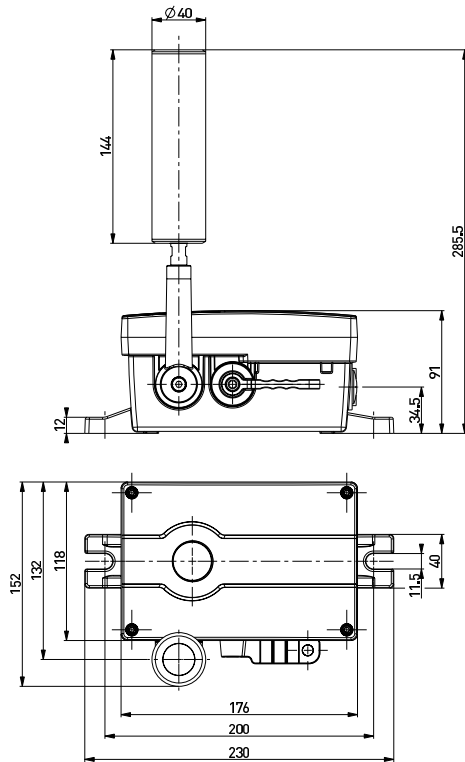

Technical data

Standards	EN ISO 13849-1; EN 60947-5-1
Enclosure	Thermoplastic
Cover	Thermoplastic
Degree of protection	IP 66/67 to IEC/EN 60529
Contact material	silver
Switching elements	3 NC/3 NO contacts or 4 NC/2 NO contacts or 2 NC/2 NO contacts or 3 NC/1 NO contacts or 4 NC contacts with double break
Switching system	snap action, positive break
Connection	NC contacts ⊖ screw terminals
Cable cross-section	max. 2.5 mm ² (incl. conductor ferrules)
Cable entry	2 x M25 x 1.5
B _{10d} (10 % Load)	200 000
T _M	max. 20 years
U _{imp}	4 kV
U _i	400 V
I _{the}	6 A
Utilisation category	AC-15
I _e /U _e	6 A/400 VAC
Max. fuse rating	6 A gG D fuse
Ambient temperature	-40 °C ... +85 °C
Mechanical life	> 100 000 operations
Light resistance EN 50014	ISO 4892

Errors and omissions excepted.



Belt-alignment switch ZS 91 SR -40°C ... +85°C IP66 Extreme

Ordering details

Snap action
Contact staggering
1 NC/1 NO / 1 NC/1 NO contact

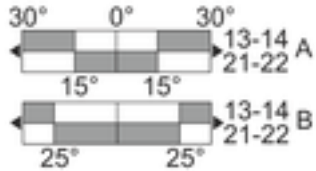

Type
ZS 91 SR 10S/10S -40°C ... +85°C IP66 Extreme

Material no.
1208202

Snap action
3 NC/3 NO contacts

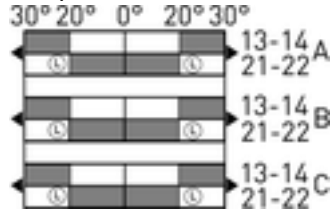

Type
ZS 91 SR 30/3S VD -40°C ... +85°C IP66 Extreme

Material no.
on request

Snap action
4 NC/2 NO contacts

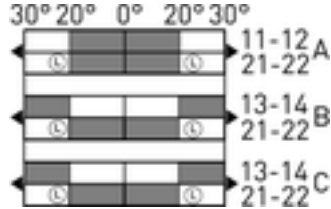

Type
ZS 91 SR 40/2S VD -40°C ... +85°C IP66 Extreme

Material no.
on request

Snap action
2 NC/2 NO contacts

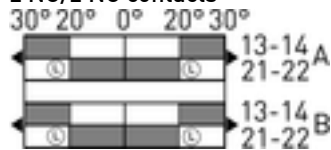

Type
ZS 91 SR 20/2S VD -40°C ... +85°C IP66 Extreme

Material no.
1213379



Belt-alignment switch ZS 91 SR -40°C ... +85°C IP66 Extreme

Ordering details

Snap action

3 NC/1 NO contact

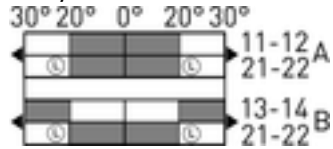

Type

ZS 91 SR 3Ö/1S VD -40°C ... +85°C IP66 Extreme

Material no.

on request

Snap action

4 NC contacts

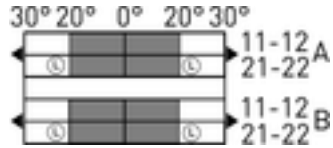

Type

ZS 91 SR 4Ö VD -40°C ... +85°C IP66 Extreme

Material no.

on request