



## Spínače pro sledování vystředění pásových dopravníků ZS 75 SR

### Vlastnosti/možnosti



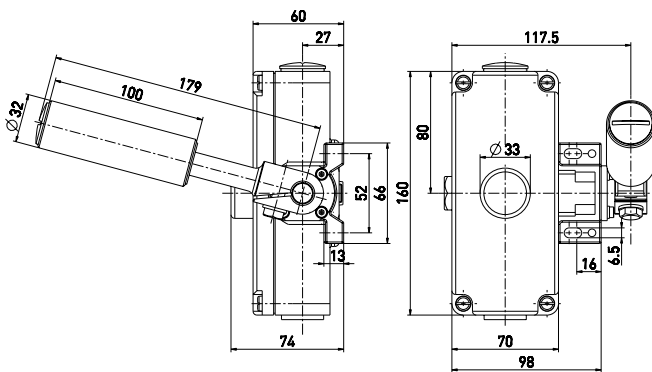

- Metal enclosure
- 2 or 4 contacts
- Release by push button (VD) or key (VS) possible
- Belt-alignment roller made of stainless steel 1.4104
- Version with Dupline or Dupline Safe available on request

- Indicator lamps for various voltages are indicated in chapter accessories in the appendix
- Indicator lamp position in the left side cable entry, other positions possible on request
- Ex version available
- Version for low temperatures down to -40 °C with high degree of protection IP 67 available - see chapter [/ ZS 75 SR -40°C IP67 Extreme >](#)

### Rozměry



### Technická data

Standards	EN ISO 13849-1; EN 60947-5-1
Enclosure	aluminium die-cast, enamel finish
Cover	aluminium die-cast, enamel finish
Degree of protection	ZS 75 SR VD: IP 65 ZS 75 SR VS: IP 54 to IEC/EN 60529
Contact material	silver
Switching elements	change-over contact with double break or 2 NC/2 NO or 4 NC contacts
Switching system	snap action, positive break NC contacts $\ominus$
Connection	screw terminals
Cable section	max. 2.5 mm <sup>2</sup> (incl. conductor ferrules)
Cable entry	2 x M25 x 1.5
B <sub>10d</sub> (10 % Load)	ZS 75 SR VD/VS: 200.000; ZS 75 SR: 2 million
T <sub>M</sub>	max. 20 years
U <sub>imp</sub>	6 kV
U <sub>i</sub>	400 V
I <sub>the</sub>	6 A
Utilisation category	AC-15
I <sub>e</sub> /U <sub>e</sub>	6 A/400 VAC
Max. fuse rating	6 A gG/gN fuse
Ambient temperature	-25 °C ... +70 °C
Mechanical life	ZS 75 SR VD/VS: > 100.000 operations; ZS 75 SR: > 1 million operations as option
Indicator lamp	as option
Approvals	   

Omyly a technické změny vyhrazeny.



## Spínače pro sledování vystředění pásových dopravníků ZS 75 SR

### Ordering details

Snap action  
1 NC/1 NO contact

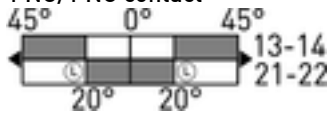

Typ  
ZS 75 SR 1Ö/1S VD  
ZS 75 SR 1Ö/1S VS

číslo materiálu  
lu  
1048342  
1048343

Snap action  
2 NC/2 NO contacts

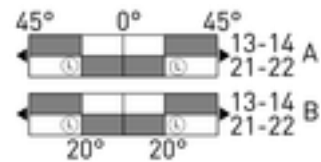

Typ  
ZS 75 SR 2Ö/2S VD  
ZS 75 SR 2Ö/2S VS

číslo materiálu  
lu  
1169350  
1169360

Snap action  
4 NC contacts

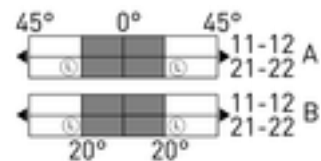

Typ  
ZS 75 SR 4Ö VD  
ZS 75 SR 4Ö VS

číslo materiálu  
lu  
na vyžádání  
na vyžádání

Snap action  
1 NC/1 NO contact  
without latching

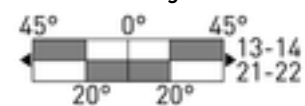

Typ  
ZS 75 SR 1Ö/1S

číslo materiálu  
lu  
1048341

Snap action  
2 NC/2 NO contacts  
without latching

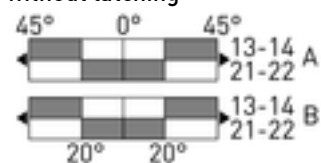

Typ  
ZS 75 SR 2Ö/2S

číslo materiálu  
lu  
1169331



## Spínače pro sledování vystředění pásových dopravníků ZS 75 SR

### Ordering details

Snap action  
4 NC contacts  
without latching

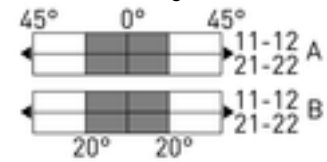

Typ  
ZS 75 SR 4Ö

číslo materiálu  
na vyžádání



## Spínače pro sledování vystředění pásových dopravníků ZS 75 SR

### Accessories

Indicator lamp glow lamp



Typ  
Indicator lamp glow lamp 24 VDC  
Indicator lamp glow lamp 230 VDC

číslo materiálu  
1164937  
1164936

Indicator lamp Multi-LED red



Typ  
Indicator lamp Multi-LED RD 24 VDC  
Indicator lamp Multi-LED RD 115 VAC  
Indicator lamp Multi-LED RD 230 VAC

číslo materiálu  
1169219  
1169221  
1178917

Indicator lamp Multi-LED white



Typ  
Indicator lamp Multi-LED WH 24 VDC  
Indicator lamp Multi-LED WH 115 VAC  
Indicator lamp Multi-LED WH 230 VAC

číslo materiálu  
1169220  
1169222  
1178916