

POSIWIRE[®]

Cable Extension Position Sensors

WS7.5
Position Sensor

Datasheet



Copyright

© ASM Automation Sensorik Messtechnik GmbH
Am Bleichbach 18-24
85452 Moosinning
Germany

The information presented in this data sheet does not form part of any quotation or contract, is believed to be accurate and reliable and may be changed without notice. No liability will be accepted by ASM for any consequence of its use. Publication thereof does not convey nor imply any license under patent or industrial or intellectual property rights. Applications that are described herein for any of these products are for illustrative purpose only.

ASM makes no representation or warranty that such applications will be suitable for the specified use without further testing or modification.

Analog output, SSI output	5
Specifications	5
Order code	6
Dimensions	7
Measurement range 10000 ... 40000 mm, analog output, SSI output	7
Magnetic encoder, analog output	8
Specifications	8
Order code	9
Magnetic encoder, analog output, programmable	10
Specifications	10
Order code	11
Magnetic encoder, analog output, redundant.....	12
Specifications	12
Order code	13
Magnetic encoder, digital output SSI	14
Specifications	14
Order code	15
Magnetic encoder, digital output CAN Bus.....	16
Specifications	16
Order code	17
Dimensions	18
Measurement range 10000 ... 40000 mm, magnetic encoder output	18
Absolute encoder output	19
Specifications	19
Order code	20
Incremental encoder output	21
Specifications	21
Order code	22
Dimensions	23
Measurement range 10000 ... 40000 mm; output: absolute and incremental encoder	23
Output ME	23
Output specification	24
Analog outputs	24
Voltage divider R1K.....	24
Signal conditioner 10V and 10V5	25
Signal conditioner 420A	26
Signal conditioner 420T	27
Signal conditioner PMUI / PMUV	28
Signal conditioner ADSI	30
Magnetic encoder, analog output.....	32
Magnetic encoder, analog output, programmable	34
Magnetic encoder, analog output, redundant	36
Magnetic encoder, digital output SSI	38
Magnetic encoder, digital output CANopen	40

Magnetic encoder, digital output CAN SAE J1939	41
Absolute encoder outputs	42
Signal conditioner HSSI	42
Interface HINT	43
Interface HPROF	44
Interface HDEV.....	45
Interface HCAN / HCANOP	46
Incremental outputs.....	47
Signal conditioner LD5VC	47
Signal conditioner PP24VC	49
Accessories.....	51
Connector cable M12, 4 pin	51
Connector cable M12, 5 pin	52
Connector cable M12, 8 pin	53
Connector/bus cable M12, 5 pin CAN-Bus	54
T-connector for bus cable M12, 5 pin CAN-Bus	54
Terminating resistor M12, 5 pin CAN-Bus	54
Plug-in connectors	55
Plug-in connector M12, 8 pin (straight coupling)	55
Plug-in connector CONIN, 12 pin (straight coupling).....	55

Analog output, SSI output

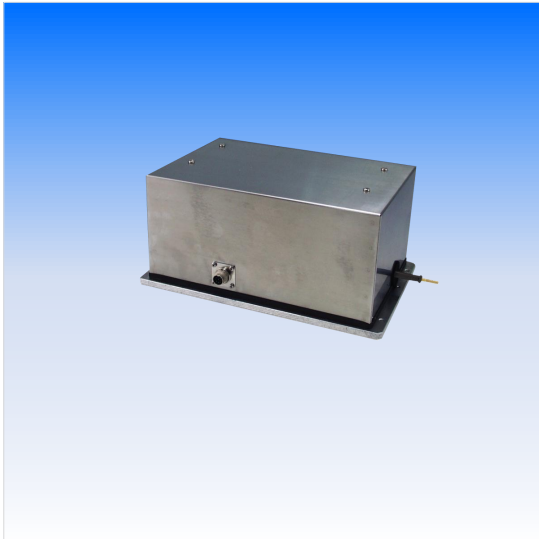

Sensor features

- Measurement range up to 40000 mm
- Protection class IP52
- Analog output, SSI output

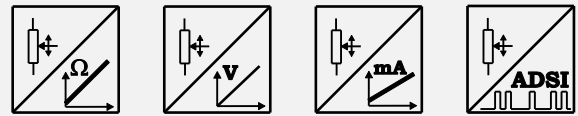

Specifications

Output	R1K = Potentiometer 1 kΩ 10V = Voltage 0 ... 10 V 420A = Current 4 ... 20 mA, 2- wires 420T = Current 4 ... 20 mA, 3 wires PMUI = Current output, programmable PMUV = Voltage output, programmable ADSI = Signal conditioner SSI 12 bit, replaced by MSS12 ADSI14 = Signal conditioner SSI 14 bit, replaced by MSS14 ADSI16 = Signal conditioner SSI 16 bit, replaced by MSS16
Resolution	Analog: quasi infinite
Linearity	±0.10% f.s. (standard) ±0.05% f.s. (optional)
Sensing device	Precision potentiometer
Housing material	Aluminium, stainless steel and plastic; measuring cable: stainless steel
Protection class	IP52
Connection	Connector M12, 8 pin
Temperature range	-20 ... +85 °C
Weight	Approx. 10 kg
EMC	DIN EN 61326-1:2013

Cable forces typical at 20 °C	Measurement range	Maximum pull-out force	Minimum pull-in force
	[mm]	[N]	[N]
	10000 – 30000	8.0	4.2
	40000	7.0	3.4

Order code

WS7.5 - 1 - 2 - 3 - 4 - 5

1 Measurement range (in mm)

10000 / 20000 / 30000 / 40000

2 Output

- R1K = Potentiometer 1 kΩ
- 10V = Voltage 0 ... 10 V
- 420A = Current 4 ... 20 mA, 2- wires
- 420T = Current 4 ... 20 mA, 3 wires
- PMUI = Current output, programmable
- PMUV = Voltage output, programmable

- ADSI = Signal conditioner SSI 12 bit, replaced by MSS12
- ADSI14 = Signal conditioner SSI 14 bit, replaced by MSS14
- ADSI16 = Signal conditioner SSI 16 bit, replaced by MSS16

3 Linearity

- L10 = ±0.10% f.s. (standard)
- L05 = ±0.05% f.s. (optional)

4 Cable fixing

- M4 = M4 cable fixing
- SB0 = cable clip

5 Connection

- M12 = Connector M12, 8 pin

Order example

WS7.5 - 30000 - 420T - L10 - M4 - M12

Accessories:

Connector cable (see page 53)

Dimensions

Measurement range 10000 ... 40000 mm, analog output, SSI output

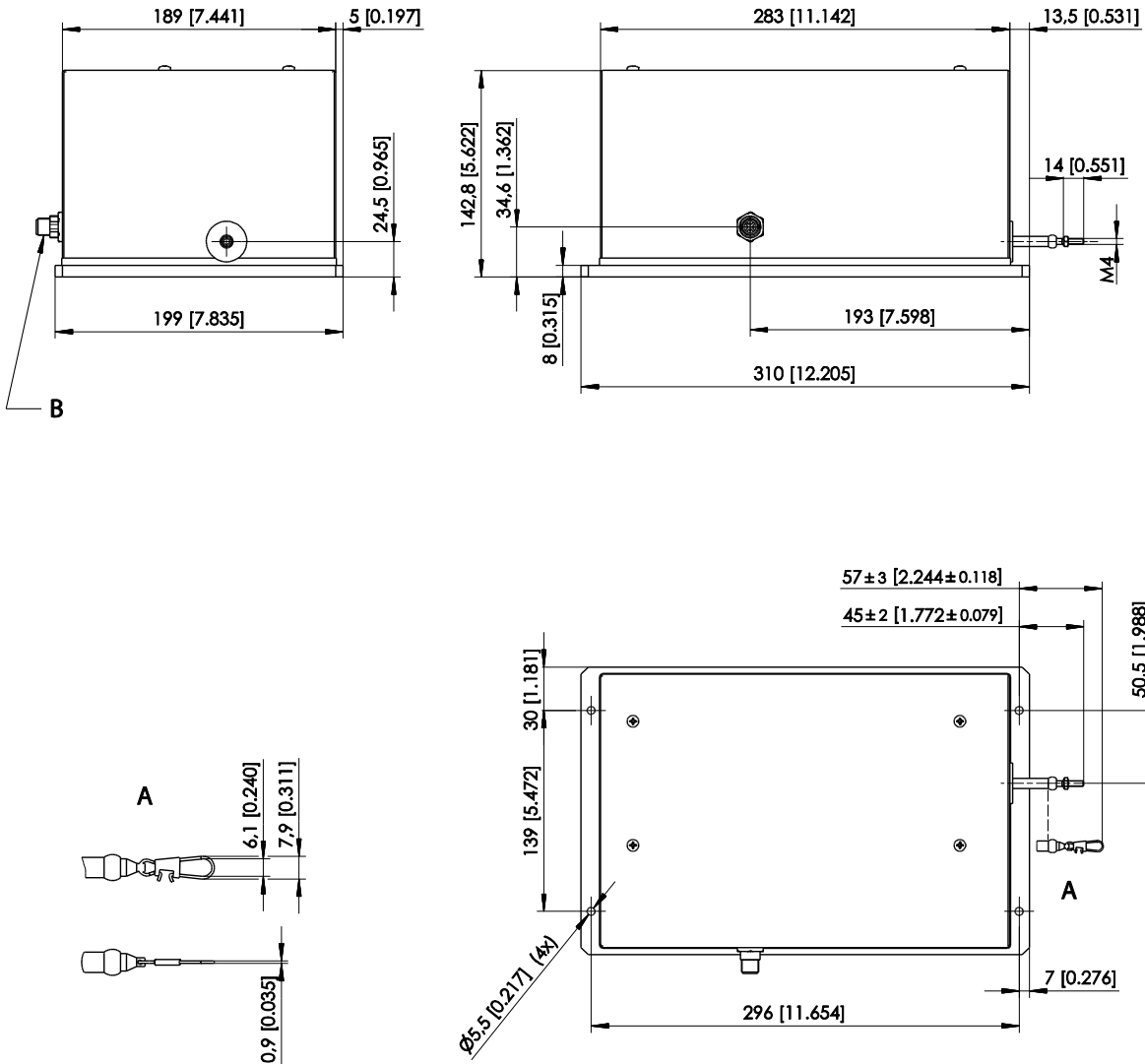

A – Option SB0
B – Connector M12

Dimensions in mm [inch]
Dimensions informative only.
For guaranteed dimensions consult factory.

Magnetic encoder, analog output

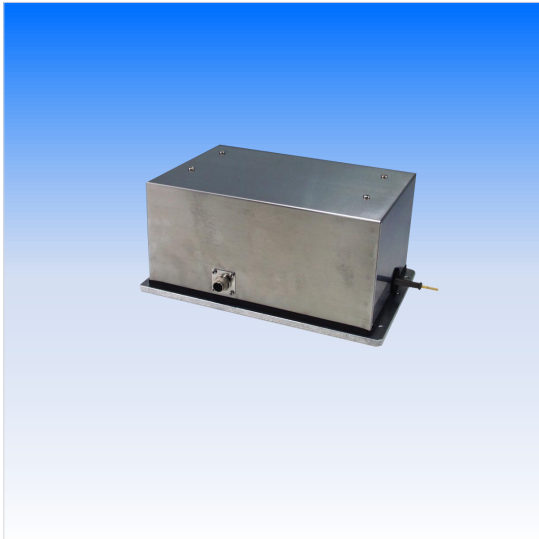

Sensor features

- With magnetic absolute encoder
- Measurement range up to 40000 mm
- Protection class IP52
- Analog output
- Absolute measurement

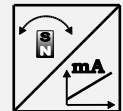
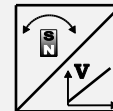

Specifications

Output	U2 = Voltage 0.5 ... 10 V U8 = Voltage 0.5 ... 4.5 V I1 = Current 4 ... 20 mA, 3 wire
Resolution	<0.002% f.s.
Linearity	±0.10% f.s. (standard) ±0.05% f.s. (optional)
Sensing device	Magnetic absolute encoder
Housing material	Aluminium, stainless steel and plastic; measuring cable: stainless steel
Protection class	IP52
Connection	Connector M12, 5 pin (standard) Connector M12, 8 pin (optional)
Shock	DIN EN 60068-2-27:2010, 100 g/11 ms, 100 shocks
Vibration	DIN EN 60068-2-6:2008, 20 g 10 Hz-2 kHz, 10 cycles
Temperature range	-20 ... +85 °C
Weight	Approx. 10 kg
EMC	DIN EN 61326-1:2013

Order code

WS7.5 - 1 - 2 - 3 - 4 - 5 - 6

1 Measurement range (in mm)

10000 / 15000 / 20000 / 25000 / 30000 / 40000

2 Output

U2 = Voltage 0.5 ... 10 V
U8 = Voltage 0.5 ... 4.5 V
I1 = Current 4 ... 20 mA, 3 wire

3 Signal characteristics

A = increasing signal (e.g. 4 ... 20 mA)
D = decreasing signal (e.g. 20 ... 4 mA)

4 Linearity

L10 = ±0.10% f.s. (standard)
L05 = ±0.05% f.s. (optional)

5 Cable fixing

M4 = M4 cable fixing
SB0 = cable clip

6 Connection

M12A5 = Connector M12, 5 pin (standard)
M12A8 = Connector M12, 8 pin (optional)

Order example

WS7.5 - 30000 - U2 - A - L10 - M4 - M12A5

Accessories:

Connector cable (see page 51)

Magnetic encoder, analog output, programmable

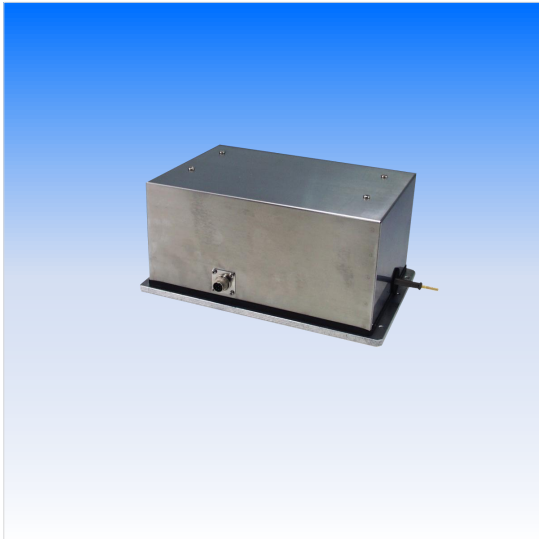

Sensor features

- With magnetic absolute encoder
- Measurement range up to 40000 mm
- Protection class IP52
- Analog output, programmable
- Absolute measurement

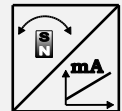
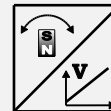

Specifications

Output	U2/PMU = Voltage 0.5 ... 10 V, programmable U8/PMU = Voltage 0.5 ... 4.5 V, programmable I1/PMU = Current 4 ... 20 mA, 3 wire, programmable
Resolution	<0.002% f.s.
Linearity	±0.10% f.s. (standard) ±0.05% f.s. (optional)
Sensing device	Magnetic absolute encoder
Housing material	Aluminium, stainless steel and plastic; measuring cable: stainless steel
Protection class	IP52
Connection	Connector M12, 5 pin
Shock	DIN EN 60068-2-27:2010, 100 g/11 ms, 100 shocks
Vibration	DIN EN 60068-2-6:2008, 20 g 10 Hz-2 kHz, 10 cycles
Temperature range	-20 ... +85 °C
Weight	Approx. 10 kg
EMC	DIN EN 61326-1:2013

Order code

WS7.5 - 1 - 2 - 3 - 4 - 5 - 6

1 Measurement range (in mm)

10000 / 15000 / 20000 / 25000 / 30000 / 40000

2 Output

U2/PMU = Voltage 0.5 ... 10 V, programmable
U8/PMU = Voltage 0.5 ... 4.5 V, programmable
I1/PMU = Current 4 ... 20 mA, 3 wire, programmable

3 Signal characteristics

A = increasing signal (e.g. 4 ... 20 mA)
D = decreasing signal (e.g. 20 ... 4 mA)

4 Linearity

L10 = ±0.10% f.s. (standard)
L05 = ±0.05% f.s. (optional)

5 Cable fixing

M4 = M4 cable fixing
SB0 = cable clip

6 Connection

M12A5 = Connector M12, 5 pin

Order example

WS7.5 - 30000 - U2/PMU - A - L10 - M4 - M12A5

Accessories:

Connector cable (see page 52)

Magnetic encoder, analog output, redundant

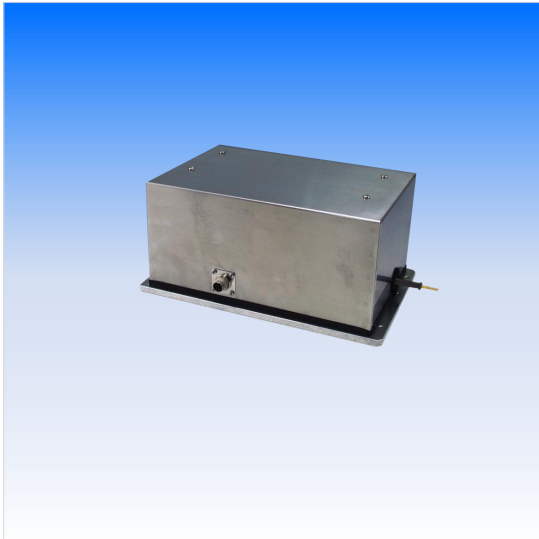

Sensor features

- With magnetic absolute encoder
- Measurement range up to 40000 mm
- Protection class IP52
- Analog output, redundant
- Absolute measurement

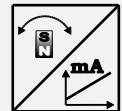
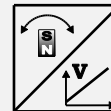

Specifications

Output	U2R = Voltage 0.5 ... 10 V, redundant U8R = Voltage 0.5 ... 4.5 V, redundant I1R = Current 4 ... 20 mA, 3 wire, redundant
Resolution	<0.002% f.s.
Linearity	±0.10% f.s. (standard) ±0.05% f.s. (optional)
Sensing device	Magnetic absolute encoder
Housing material	Aluminium, stainless steel and plastic; measuring cable: stainless steel
Protection class	IP52
Connection	Connector M12, 8 pin
Shock	DIN EN 60068-2-27:2010, 100 g/11 ms, 100 shocks
Vibration	DIN EN 60068-2-6:2008, 20 g 10 Hz-2 kHz, 10 cycles
Temperature range	-20 ... +85 °C
Weight	Approx. 10 kg
EMC	DIN EN 61326-1:2013

Order code

WS7.5 - 1 - 2 - 3 - 4 - 5 - 6

1 Measurement range (in mm)

10000 / 15000 / 20000 / 25000 / 30000 / 40000

2 Output

U2R = Voltage 0.5 ... 10 V, redundant
 U8R = Voltage 0.5 ... 4.5 V, redundant
 I1R = Current 4 ... 20 mA, 3 wire, redundant

3 Signal characteristics

A/A = Output 1 increasing, output 2 increasing
 A/D = Output 1 increasing, output 2 decreasing
 D/D = Output 1 decreasing, output 2 decreasing

4 Linearity

L10 = ±0.10% f.s. (standard)
 L05 = ±0.05% f.s. (optional)

5 Cable fixing

M4 = M4 cable fixing
 SB0 = cable clip

6 Connection

M12A8 = Connector M12, 8 pin

Order example

WS7.5 - 30000 - I1R - A/D - L10 - M4 - M12A8

Accessories:

Connector cable (see page 52)

Magnetic encoder, digital output SSI

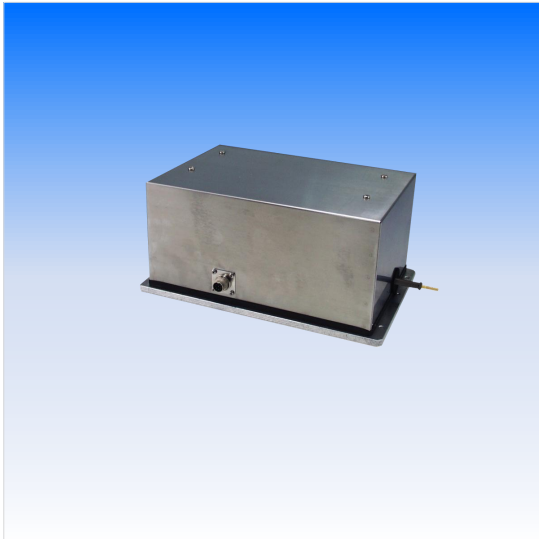

Sensor features

- With magnetic absolute encoder
- Measurement range up to 40000 mm
- Protection class IP52
- Digital output SSI
- Absolute measurement

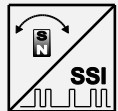

Specifications

Output	MSSI = SSI synchronous serial interface
Resolution	100
Linearity	±0.10% f.s. (standard) ±0.05% f.s. (optional)
Sensing device	Magnetic absolute encoder
Housing material	Aluminium, stainless steel and plastic; measuring cable: stainless steel
Protection class	IP52
Connection	Connector M12, 8 pin
Shock	DIN EN 60068-2-27:2010, 100 g/11 ms, 100 shocks
Vibration	DIN EN 60068-2-6:2008, 20 g 10 Hz-2 kHz, 10 cycles
Temperature range	-20 ... +85 °C
Weight	Approx. 10 kg
EMC	DIN EN 61326-1:2013

Order code

WS7.5 - 1 - 2 - 3 - 4 - 5 - 6

1 Measurement range (in mm)

10000 / 15000 / 20000 / 25000 / 30000 / 40000

2 Resolution (in µm)

100

3 Output

MSSI = SSI synchronous serial interface

4 Linearity

L10 = ±0.10% f.s. (standard)

L05 = ±0.05% f.s. (optional)

5 Cable fixing

M4 = M4 cable fixing

SB0 = cable clip

6 Connection

M12A8 = Connector M12, 8 pin

Order example

WS7.5 - 30000 - 100 - MSSI - L10 - M4 - M12A8

Accessories:

Connector cable (see page 53)

Magnetic encoder, digital output CAN Bus

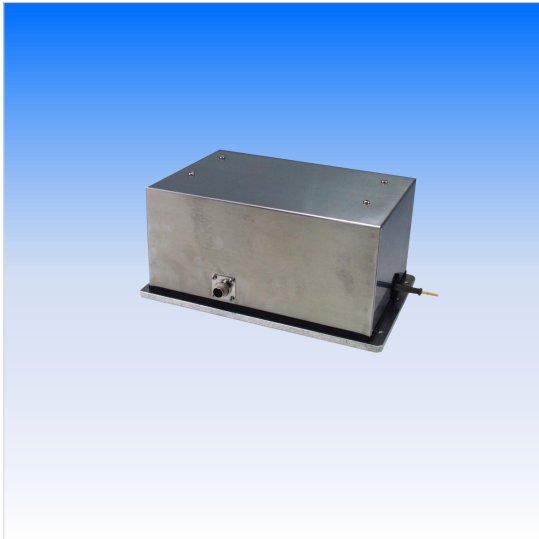

Sensor features

- With magnetic absolute encoder
- Measurement range up to 40000 mm
- Protection class IP52
- Digital output CAN Bus
- Absolute measurement
- Optional redundant CAN Bus



Specifications

Output	MCANOP = CANopen MCANJ1939 = CAN SAE J1939 MCANOPR = CANopen redundant MCANJ1939R = CAN SAE J1939 redundant
Resolution	setting via CAN Bus
Linearity	±0.10% f.s. (standard) ±0.05% f.s. (optional)
Sensing device	Magnetic absolute encoder
Housing material	Aluminium, stainless steel and plastic; measuring cable: stainless steel
Protection class	IP52
Connection	Connector M12, 5 pin
Temperature range	-20 ... +85 °C
Weight	Approx. 10 kg
EMC	DIN EN 61326-1:2013

Cable forces typical at 20 °C	Measurement range	Maximum pull-out force	Minimum pull-in force
	[mm]	[N]	[N]
	10000 – 30000	8.0	4.2
	40000	7.0	3.4

Order codeWS7.5 – 1 – 2 – 3 – 4 – 5**1 Measurement range (in mm)**

10000 / 15000 / 20000 / 25000 / 30000 / 40000

2 Output

MCANOP = CANopen
MCANJ1939 = CAN SAE J1939
MCANOPR = CANopen redundant
MCANJ1939R = CAN SAE J1939 redundant

3 Linearity

L10 = ±0.10% f.s. (standard)
L05 = ±0.05% f.s. (optional)

4 Cable fixing

M4 = M4 cable fixing
SB0 = cable clip

5 Connection

M12/CAN = Connector M12, 5 pin

Order example

WS7.5 – 30000 – MCANOP – L10 – M4 – M12/CAN

Accessories:**Connector cable (see page 54)**

Dimensions

Measurement range 10000 ... 40000 mm, magnetic encoder output

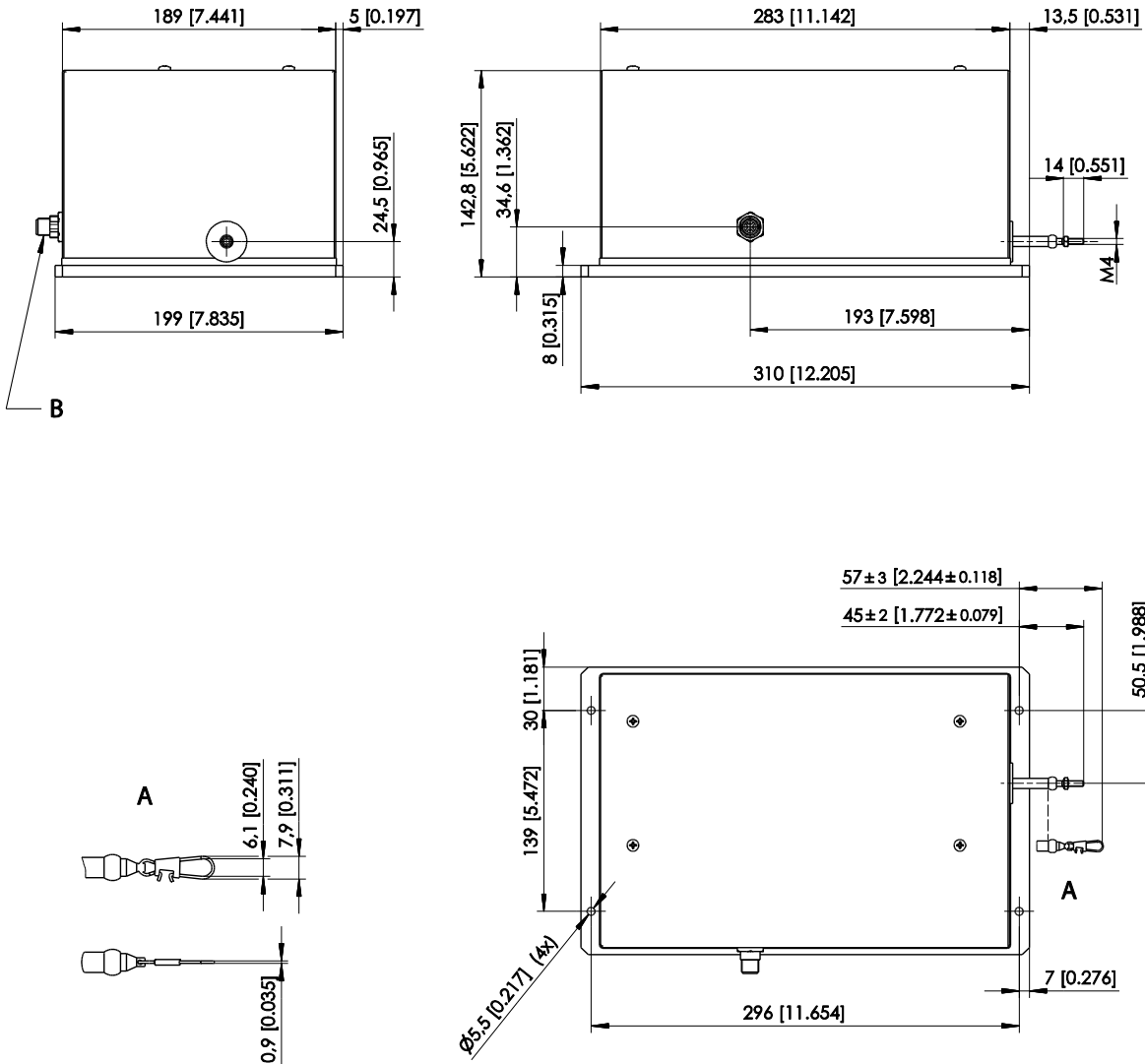

A – Option SB0
 B – Connector M12

Dimensions in mm [inch]
 Dimensions informative only.
 For guaranteed dimensions consult factory.

Absolute encoder output

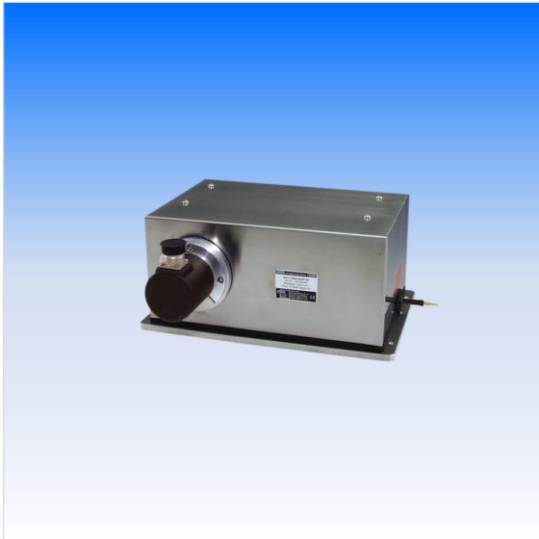

Sensor features

- Measurement range up to 40000 mm
- Protection class IP52, encoder IP64
- Absolute encoder output



Specifications

Output	HSSI = Absolute encoder with synchronous serial output (SSI) HPROF = Absolute encoder with Profibus interface HINT = Absolute encoder with Interbus interface HDEV = Absolute encoder with DeviceNet interface HCAN = Absolute encoder with CAN-interface HCANOP = Absolute encoder with CANopen interface ME = Mechanism only for suitable multiturn encoders
Resolution for 12 bit per revolution (4096 steps/ revolution)	Up to 30000 mm: 0.073 mm 40000 mm: 0.088 mm
Linearity	±0.05% f.s. (standard) ±0.01% f.s. (optional)
Sensing device	Absolute encoder
Housing material	Aluminium, stainless steel and plastic; measuring cable: stainless steel
Protection class	IP52, encoder IP64
Connection	Depending on the type of encoder: connector or Bus cover
Temperature range	-20 ... +85 °C
Weight	Approx. 10 kg max.
EMC	DIN EN 61326-1:2013

Cable forces typical at 20 °C	Measurement range	Maximum pull-out force	Minimum pull-in force
	[mm]	[N]	[N]
	10000 – 30000	8.0	4.2
	40000	7.0	3.4

Order code

WS7.5 - 1 - 2 - 3 - 4

1 Measurement range (in mm)

10000 / 15000 / 20000 / 25000 / 30000 / 40000

2 Output

- HSSI** = Absolute encoder with synchronous serial output (SSI)
- HPROF** = Absolute encoder with Profibus interface
- HINT** = Absolute encoder with Interbus interface
- HDEV** = Absolute encoder with DeviceNet interface
- HCAN** = Absolute encoder with CAN-interface
- HCANOP** = Absolute encoder with CANopen interface
- ME** = Mechanism only for suitable multiturn encoders

3 Linearity (optional)

- L01** = ±0.01% f.s.

4 Cable fixing

- M4** = M4 cable fixing
- SB0** = cable clip

Order example

WS7.5 - 3000 - HSSI - M4

Accessories:

Mating connector CONN-CONIN-12F-G (see page 55)

Incremental encoder output

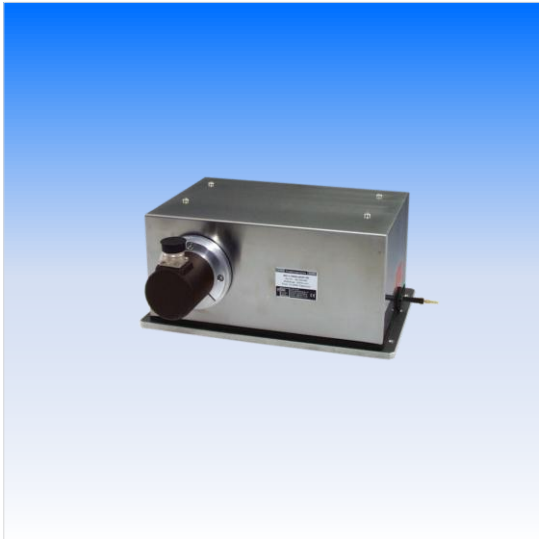

Sensor features

- Measurement range up to 40000 mm
- Protection class IP52, encoder IP64
- Incremental encoder output

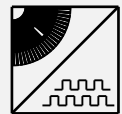

Specifications

Output	LD5VC = Incremental encoder TTL compatible PP24VC = Incremental encoder HTL compatible
Resolution	Up to 30000 mm: 13,69 pulses / mm 40000mm: 11,36 pulses / mm
Linearity	±0.05% f.s. (standard) ±0.01% f.s. (optional)
Sensing device	Incremental encoder
Housing material	Aluminium, stainless steel and plastic; measuring cable: stainless steel
Protection class	IP52, encoder IP64
Connection	Connector 12 pin
Temperature range	-20 ... +85 °C
Weight	Approx. 10 kg max.
EMC	DIN EN 61326-1:2013

Cable forces typical at 20 °C	Measurement range	Maximum pull-out force	Minimum pull-in force
	[mm]	[N]	[N]
	10000 – 30000	8.0	4.2
	40000	7.0	3.4

Order code

WS7.5 - 1 - 2 - 3 - 4

1 Measurement range (in mm)

10000 / 20000 / 30000 / 40000

2 Output

LD5VC = Incremental encoder TTL compatible
PP24VC = Incremental encoder HTL compatible

3 Linearity (optional)

L01 = ±0.01% f.s.

4 Cable fixing

M4 = M4 cable fixing
SB0 = cable clip

Order example

WS7.5 - 30000 - LD5VC - M4

Accessories:

Mating connector CONN-CONIN-12F-G (see page 55)

Dimensions

Measurement range 10000 ... 40000 mm; output: absolute and incremental encoder

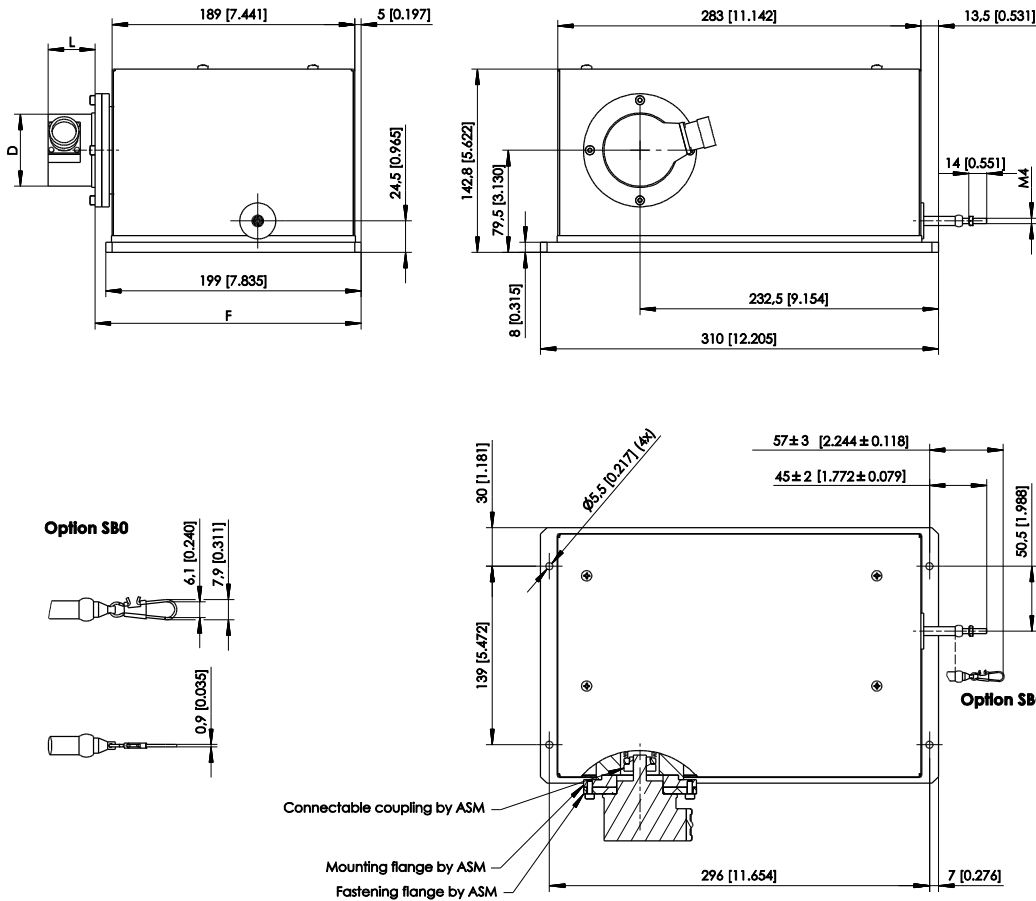

Dimensions in mm [inch]

Dimensions D, F and L depend on the encoder type and sensor fixing.

Dimensions informative only. For guaranteed dimensions consult factory.

Output ME

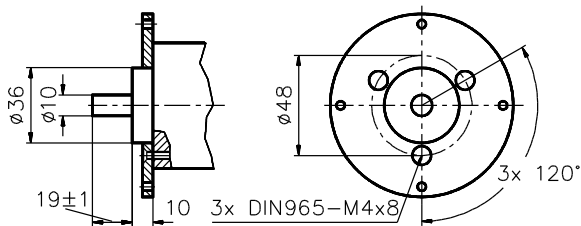

Dimensions for encoder mounting

Connectable coupling in two parts

The outer part of the coupling should be fitted to the encoder shaft. Adjust a 0.5 mm clearance between the fastening and the mounting flanges to give an initial tension on the coupling when the mounting bolts are tightened.

Output specification

Analog outputs

Voltage divider R1K

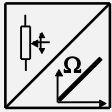
Potentiometer 	Excitation voltage	32 V DC max. at 1 kΩ (max. power 1 W)
	Potentiometer impedance	1 kΩ ±10 %
	Thermal coefficient	±25 x 10 ⁻⁶ / °C f.s.
	Sensitivity	Depends on the measuring range, individual sensitivity of the sensor is specified on the label
	Voltage divider utilization range	approx. 3 % ... 97 %
	Operating temperature	Refer to output specification
	EMC	DIN EN 61326-1:2013

Output signals

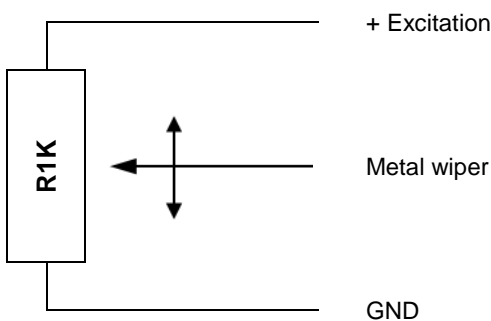

Note:

The metal wiper of the potentiometer must be protected against current load!

Electrical current flow impact on the wiper causes linearity errors and shortens the lifetime of the potentiometer.

Additional information:

http://www.asm-sensor.com/asm/pdf/pro/ws_poti_technote_en.pdf

Signal wiring

Signal	Connector pin no.	Cable color	Cable color
Poti +	1	white	brown
Poti GND	2	brown	white
Poti slider	3	green	blue
-	4	yellow	black
-	5	grey	-
-	6	pink	-
-	7	blue	-
-	8	red	-

View to sensor connector



CONN-M12-8F

Signal conditioner 10V and 10V5

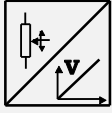
Voltage output 	Excitation voltage	18 ... 27 V DC non stabilized
	Excitation current	20 mA max.
	Output voltage	10V: 0 ... 10 V DC; 10V5: 0.5 ... 10 V DC
	Output current	2 mA max.
	Output load	> 5 kΩ
	Stability (temperature)	±50 x 10 ⁻⁶ / °C f.s.
	Protection	Reverse polarity, short circuit
	Output noise	0.5 mV _{RMS}
	Operating temperature	Refer to output specification
	EMC	DIN EN 61326-1:2013

Output signals

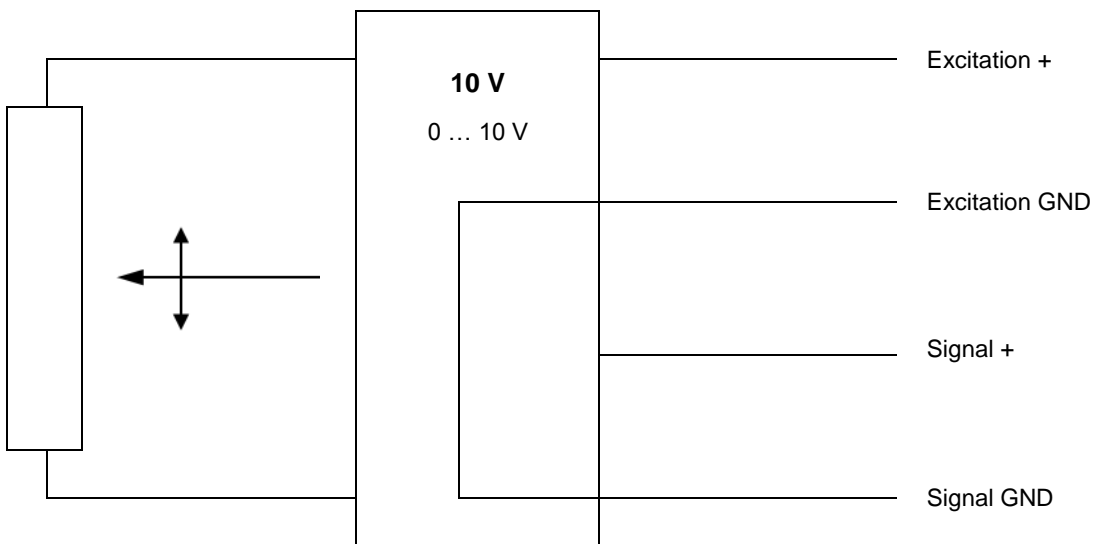

Signal wiring

Signal	Connector pin no.	Cable color	View to sensor connector
Excitation +	1	white	 CONN-M12-8F
Excitation GND	2	brown	
Signal +	3	green	
Signal GND	4	yellow	
Not connected	5	grey	
Not connected	6	pink	
Not connected	7	blue	
Not connected	8	red	

Signal conditioner 420A

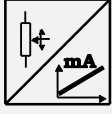
Current output (2 wire) 	Excitation voltage	12 ... 27 V DC non stabilized, measured at the sensor terminals
	Excitation current	35 mA max.
	Output current	4 ... 20 mA equivalent for 0 ... 100 % range
	Stability (temperature)	$\pm 100 \times 10^{-6} / ^\circ\text{C}$ f.s.
	Protection	Reversed polarity, short circuit
	Output noise	0.5 mV _{eff}
	Operating temperature	Refer to output specification
	EMC	DIN EN 61326-1:2013

Output signals

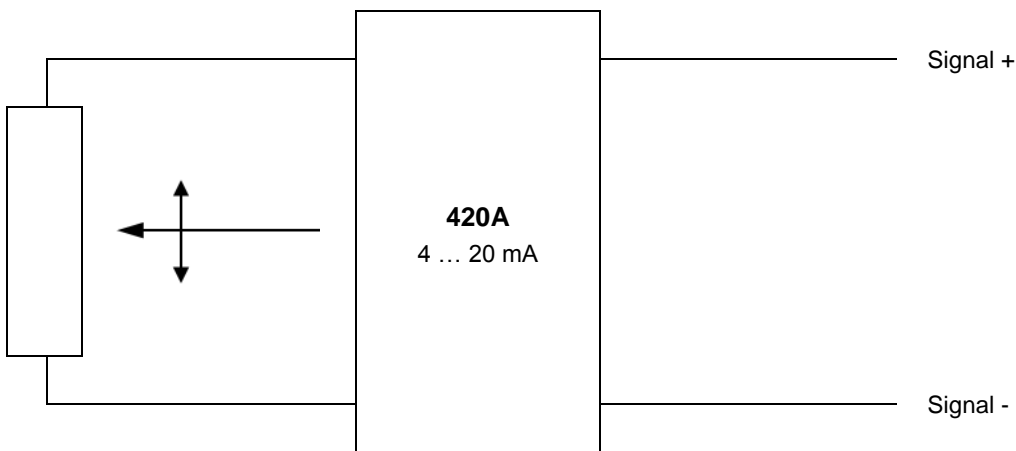

Signal wiring

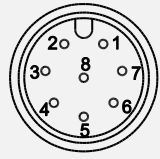
Signal	Connector pin no.	Cable color	View to sensor connector
Signal +	1	white	 CONN-M12-8F
Signal -	2	brown	
Not connected	3	green	
Not connected	4	yellow	
Not connected	5	grey	
Not connected	6	pink	
Not connected	7	blue	
Not connected	8	red	

Signal conditioner 420T

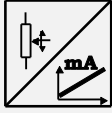
Current output (3 wire) 	Excitation voltage	18 ... 27 V DC non stabilized
	Excitation curren	40 mA max.
	Load resistor	350 Ω max.
	Output current	4 ... 20 mA equivalent for 0 ... 100 % range
	Stability (temperature)	$\pm 50 \times 10^{-6} / ^\circ\text{C}$ f.s.
	Protection	Reverse polarity, short circuit
	Output noise	0.5 mV _{RMS}
	Operating temperature	Refer to output specification
	EMC	DIN EN 61326-1:2013

Output signals

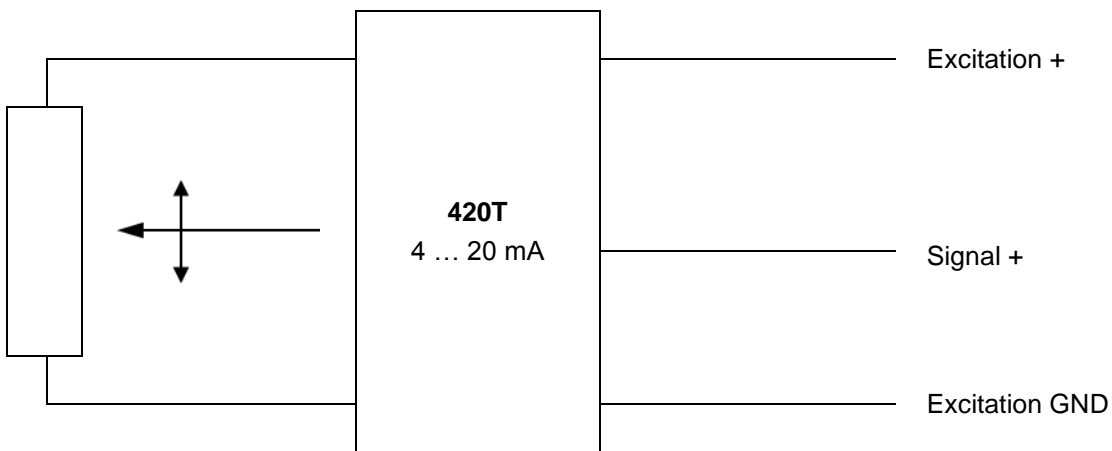

Signal wiring

Signal	Connector pin no.	Cable color	View to sensor connector
Excitation +	1	white	
Excitation GND	2	brown	
Signal +	3	green	
Not connected	4	yellow	
Not connected	5	grey	
Not connected	6	pink	
Not connected	7	blue	
Not connected	8	red	

Signal conditioner PMUI / PMUV

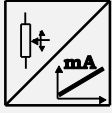
Voltage or current output (3 wire) 	Excitation voltage	18 ... 27 V DC
	Excitation current	50 mA max.
	Voltage output PMUV	0 ... 10 V
	Output current	10 mA max.
	Output load	1 kΩ min.
	Current output PMUI	4 ... 20 mA (3 wire)
	Working resistance	500 Ω max.
	Scaling	
	Activation of offset and gain adjust	Connect with excitation GND (0 V)
	Scalable range	90 % max. f.s.
	Stability (temperature)	±50 x 10 ⁻⁶ / °C f.s.
	Operating temperature	Refer to output specification
	Protection	Reversed polarity, short circuit
	EMC	DIN EN 61326-1:2013

Output signals

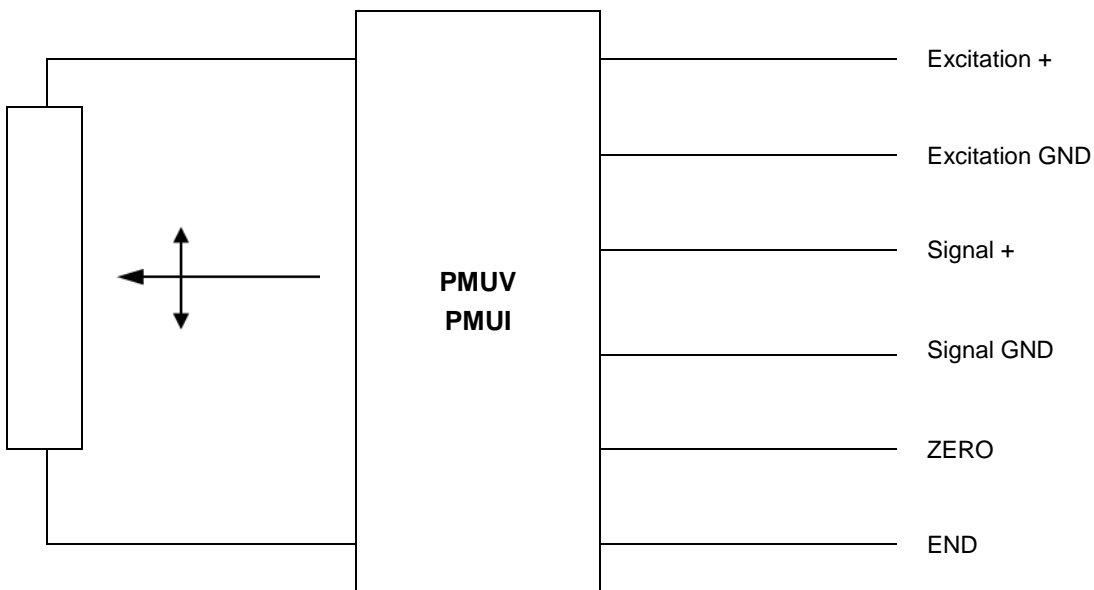

Signal wiring PMUV / PMUI

Signal	Connector pin no.	Cable color	View to sensor connector  CONN-M12-8F
Excitation +	1	white	
Excitation GND	2	brown	
Signal +	3	green	
Signal GND	4	yellow	
Not connected	5	grey	
Not connected	6	pink	
ZERO	7	blue	
END	8	red	

Signal wiring PMUI2

Signal	Connector pin no.	Cable color	View to sensor connector  CONN-M12-8F
Excitation +	1	white	
Excitation GND	2	brown	
Not connected	3	green	
Not connected	4	yellow	
Signal +	5	grey	
Signal GND	6	pink	
ZERO	7	blue	
END	8	red	

Signal conditioner ADSI

A/D converted synchronous serial 	Excitation voltage	11 ... 27 V DC
	Excitation current	200 mA max.
	Interface	EIA RS422, RS485, short-circuit proof
	Clock frequency	70 ... 500 kHz
	Code	Gray-Code, continuous progression
	Delay between pulse trains	30 µs min.
	Resolution	ADSI16: 16 bit (65536 counts) f.s. ADSI14: 14 bit (16384 counts) f.s. ADSI: 12 bit (4096 counts) f.s.
	Stability (temperature)	±50 x 10 ⁻⁶ / °C f.s.
	Operating temperature	-20 ... +85 °C
	EMC	DIN EN 61326-1:2013

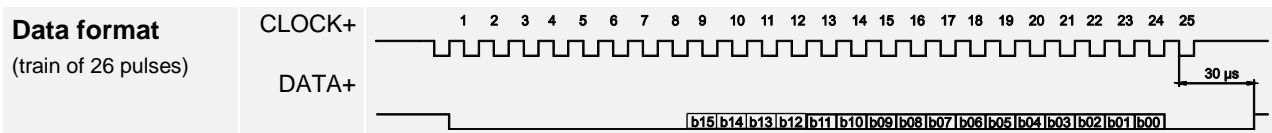

Recommended processing circuit

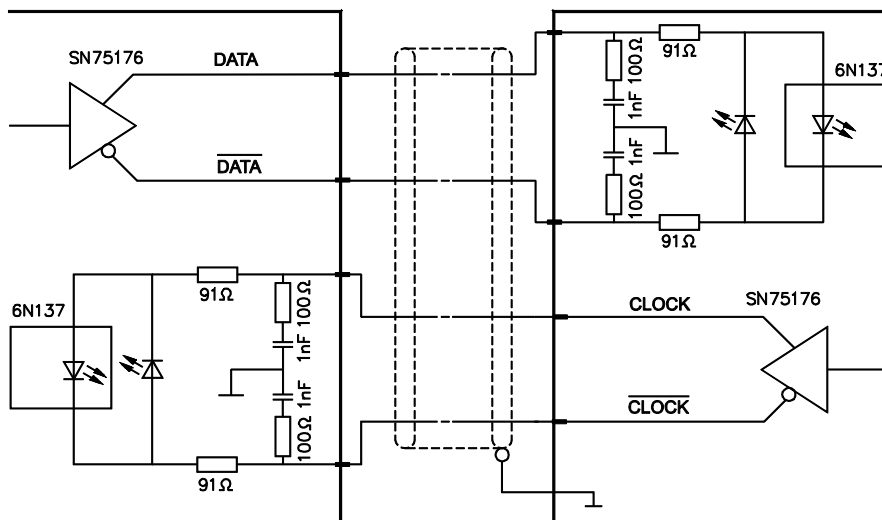

Transmission rate	Cable length	Baud rate
	< 50 m	< 300 kHz
	< 100 m	< 100 kHz

Note:
Extension of the cable length will reduce the maximum transmission rate.

Signal wiring

Signal	Connector pin no.	Cable color	View to sensor connector
Excitation +	1	white	
Excitation GND (0 V)	2	brown	
CLOCK	3	green	
$\overline{\text{CLOCK}}$	4	yellow	
DATA	5	grey	
$\overline{\text{DATA}}$	6	pink	
Shield, not connected	7	blue	
Not connected	8	red	

CONN-M12-8F

Magnetic encoder, analog output

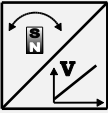
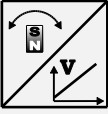
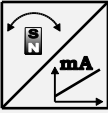
<p>U2</p> <p>Voltage output 0.5 ... 10 V</p> 	Excitation voltage	8 ... 36 V DC
	Excitation current	20 mA typical at 24 V DC 38 mA typical at 12 V DC max. 50 mA
	Output voltage	0.5 ... 10 V DC
	Output current	2 mA max.
	Measuring rate	1 kHz standard
	Stability (temperature)	$\pm 50 \times 10^{-6} / ^\circ\text{C}$ f.s. (typical)
	Protection	Reverse polarity, short circuit
	Operating temperature	See specification of the respective sensor
	EMC	DIN EN 61326-1:2013
<p>U8</p> <p>Voltage output 0.5 ... 4.5 V</p> 	Excitation voltage	8 ... 36 V DC
	Excitation current	17 mA typical at 24 V DC 32 mA typical at 12 V DC 50 mA max.
	Output voltage	0.5 ... 4.5 V DC
	Output current	2 mA max.
	Measuring rate	1 kHz standard
	Stability (temperature)	$\pm 50 \times 10^{-6} / ^\circ\text{C}$ f.s. (typical)
	Protection	Reverse polarity, short circuit
	Operating temperature	See specification of the respective sensor
	EMC	DIN EN 61326-1:2013
<p>I1</p> <p>Current output 4 ... 20 mA, 3 wires</p> 	Excitation voltage	8 ... 36 V DC
	Excitation current	typical 36 mA at 24 V DC typical 70 mA at 12 V DC 120 mA max.
	Load R_L	500 Ω max.
	Output current	4 ... 20 mA
	Measuring rate	1 kHz standard
	Stability (temperature)	$\pm 50 \times 10^{-6} / ^\circ\text{C}$ f.s. (typical)
	Protection	Reverse polarity, short circuit
	Operating temperature	See specification of the respective sensor
	EMC	DIN EN 61326-1:2013

Signal wiring

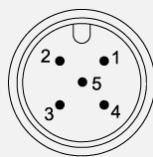
Signal	Connector pin no.	Cable connection	View to the sensor connector
Excitation +	1	brown	
Signal	2	white	
GND	3	blue	
Do not connect!	4	black	
Do not connect!	5	(grey)	

Signal diagram

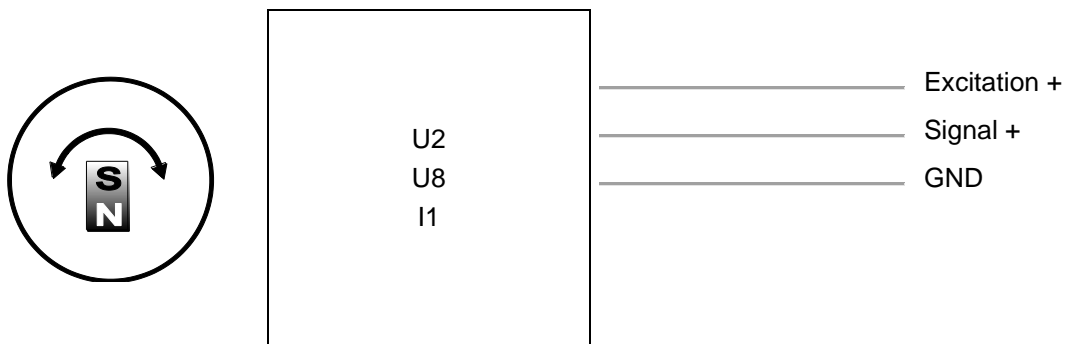

Magnetic encoder, analog output, programmable

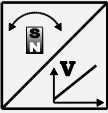
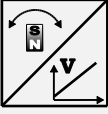
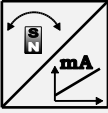
<p>U2/PMU</p> <p>Voltage output 0.5 ... 10 V</p> 	Excitation voltage	8 ... 36 V DC
	Excitation current	20 mA typical at 24 V DC 38 mA typical at 12 V DC max. 50 mA
	Output voltage	0,5 ... 10 V DC
	Output current	2 mA max.
	Measuring rate	1 kHz standard
	Stability (temperature)	$\pm 50 \times 10^{-6} / ^\circ\text{C}$ f.s. (typical)
	Protection	Reverse polarity, short circuit
	Operating temperature	See specification of the respective sensor
	EMC	EN 61326-1:2013
	<p>U8/PMU</p> <p>Voltage output 0.5 ... 4.5 V</p> 	Excitation voltage
Excitation current		17 mA typical at 24 V DC 32 mA typical at 12 V DC max. 50 mA
Output voltage		0.5 ... 4.5 V DC
Output current		2 mA max.
Measuring rate		1 kHz standard
Stabilität (Temperatur)		$\pm 50 \times 10^{-6} / ^\circ\text{C}$ f.s. (typical)
Protection		Reverse polarity, short circuit
Operating temperature		See specification of the respective sensor
EMC		DIN EN 61326-1:2013
<p>I1/PMU</p> <p>Current output 4 ... 20 mA, 3 wires</p> 		Excitation voltage
	Excitation current	typical 36 mA at 24 V DC typical 70 mA at 12 V DC max. 120 mA
	Load R _L	500 Ω max.
	Output current	4 ... 20 mA
	Measuring rate	1 kHz standard
	Stability (temperature)	$\pm 50 \times 10^{-6} / ^\circ\text{C}$ f.s. (typical)
	Protection	Reverse polarity, short circuit
	Operating temperature	See specification of the respective sensor
	EMC	DIN EN 61326-1:2013

Signal wiring

Signal	Connector pin no.	Cable color	View to sensor connector
Excitation +	1	brown	
Signal	2	white	
GND	3	blue	
Do not connect!	4	black	
SPAN/ZERO	5	grey	

Signal diagram

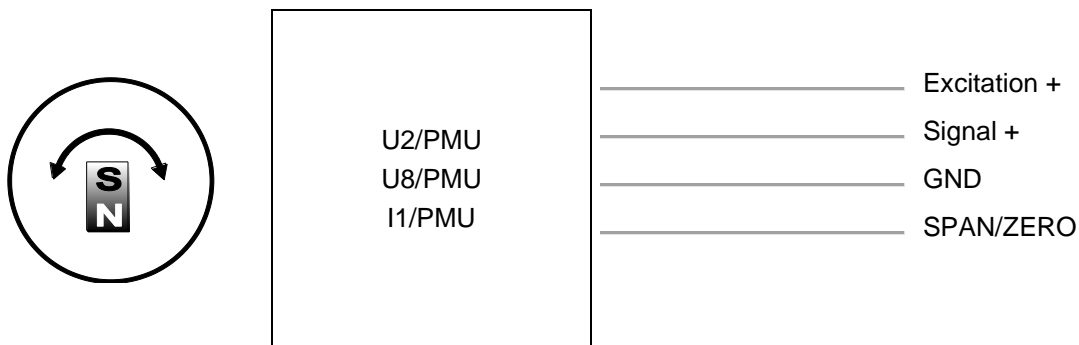

Option -PMU

Programming of the start and end value by the customer

Teach-In of start and end value for the options U2/PMU, I1/PMU, U8/PMU is provided by a binary signal SPAN/ZERO. At the start position connect signal SPAN/ZERO for a period of 2 ... 3 seconds to GND via push button. At the end position connect signal SPAN/ZERO for a period of 5 ... 6 seconds to GND via a push button. The scaling taught in that way will be stored non-volatile.

To reset the sensor to factory default signal ZERO/END must be connected to ground while powering up the sensor for 2 ... 3 seconds. For the option PMZ only teach-in of ZERO position is possible.

Magnetic encoder, analog output, redundant

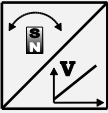
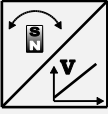
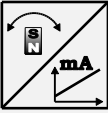
<p>U2R</p> <p>Voltage output 0.5 ... 10 V</p> 	Excitation voltage	8 ... 36 V DC
	Excitation current	20 mA typical at 24 V DC 38 mA typical at 12 V DC max. 50 mA per channel
	Output voltage	0.5 ... 10 V DC
	Output current	2 mA max.
	Measuring rate	1 kHz standard
	Stability (temperature)	$\pm 50 \times 10^{-6} / ^\circ\text{C}$ f.s. (typical)
	Protection	Reverse polarity, short circuit
	Operating temperature	See specification of the respective sensor
	EMC	DIN EN 61326-1:2013
<p>U8R</p> <p>Voltage output 0.5 ... 4.5 V</p> 	Excitation voltage	8 ... 36 V DC
	Excitation current	17 mA typical at 24 V DC 32 mA typical at 12 V DC max. 50 mA per channel
	Output voltage	0.5 ... 4.5 V DC
	Output current	2 mA max.
	Measuring rate	1 kHz standard
	Stability (temperature)	$\pm 50 \times 10^{-6} / ^\circ\text{C}$ f.s. (typical)
	Protection	Reverse polarity, short circuit
	Operating temperature	See specification of the respective sensor
	EMC	DIN EN 61326-1:2013
<p>I1R</p> <p>Current output 4 ... 20 mA, 3 wires</p> 	Excitation voltage	8 ... 36 V DC
	Excitation current	36 mA typical at 24 V DC 76 mA typical at 12 V DC max. 120 mA per channel
	Load R_L	500 Ω max.
	Output current	4 ... 20 mA
	Measuring rate	1 kHz standard
	Stability (temperature)	$\pm 50 \times 10^{-6} / ^\circ\text{C}$ f.s. (typical)
	Protection	Reverse polarity, short circuit
	Operating temperature	See specification of the respective sensor
	EMC	DIN EN 61326-1:2013

Signal wiring

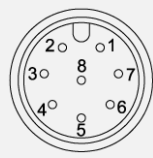
Channel	Signal	Connector pin no.	Cable color	View to the sensor connector
1	Excitation +	1	white	
1	Signal	2	brown	
1	GND	3	green	
1	Do not connect!	4	yellow	
2	Excitation +	5	grey	
2	Signal	6	pink	
2	GND	7	blue	
2	Do not connect!	8	red	

Signal diagram

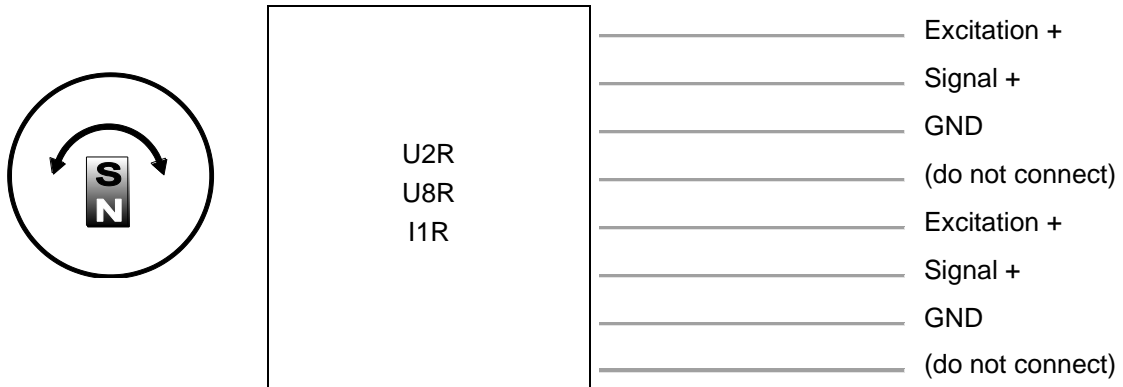

Magnetic encoder, digital output SSI

MSSI Synchronous serial SSI 	Interface	EIA RS-422
	Excitation voltage	8 ... 36 V DC
	Excitation current	19 mA typical at 24 V DC 35 mA typical at 12 V DC max. 80 mA
	Clock frequency	100 kHz ... 500 kHz
	Code	Gray-Code, continuous progression
	Delay between pulse trains (t_p)	30 μ s min.
	Stability (temperature)	$\pm 50 \times 10^{-6} / ^\circ\text{C}$ f.s. (typical)
	Operating temperature	See specification of the respective sensor
	Protection	Reverse polarity, short circuit
	EMC	DIN EN 61326-1:2013

Data format

(Train of 26 pulses)

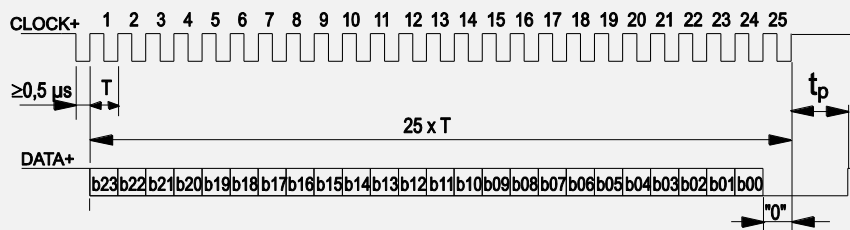

Recommended processing circuit

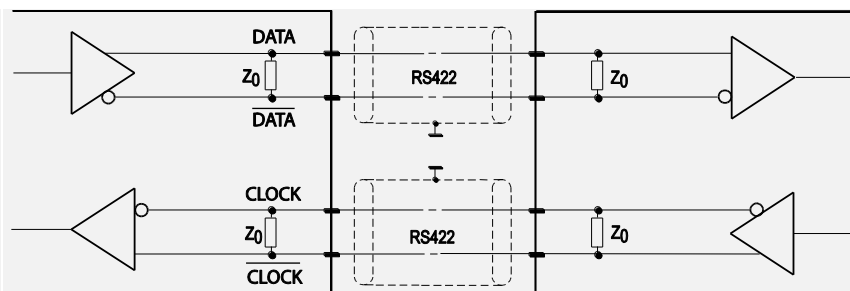

Transmission rate	Cable length	Baud rate
	50 m	100-400 kHz
	100 m	100-300 kHz

Note:

Extension of the cable length will reduce the maximum transmission rate.

Signal wiring

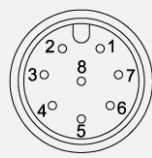
Signal	Connector pin no.	Cable color	View to sensor connector
Excitation +	1	white	
Excitation GND	2	brown	
CLOCK	3	green	
$\overline{\text{CLOCK}}$	4	yellow	
DATA	5	grey	
$\overline{\text{DATA}}$	6	pink	
-	7	blue	
-	8	red	

Magnetic encoder, digital output CANopen

MCANOP, CANOPR CANopen 	CAN specification	ISO 11898, Basic and Full CAN 2.0 B
	Communication profile	CANopen CiA 301 V 4.02, Slave
	Encoder profile	Encoder CiA 406 V 3.2
	Error Control	Node Guarding, Heartbeat, Emergency Message
	Node ID	Adjustable via LSS or SDO, default: 127
	PDO	3 TxPDO, 0 RxPDO, no linking, static mapping
	PDO Modes	Event-/Time triggered, Remote-request, Sync cyclic/acyclic
	SDO	1 Server, 0 Client
	CAM	8 cams
	Certified	Yes
	Transmission rate	50 kBit bis 1 Mbit, adjustable via LSS or SDO, default: 125 kBit
	Bus connection	M12 connector, 5 pin
	Integrated bus terminating resistor	120Ω adjustable by the customer
	Bus, galvanic isolated	no

Specifications	Excitation voltage	8 ... 36 V DC
	Excitation current	20 mA typical at 24 V DC 40 mA typical at 12 V DC, 80 mA max.
	Measuring rate	1 kHz (asynchronous)
	Stability (temperature)	±50 x 10 ⁻⁶ /°C f.s. (typical)
	Repeatability	1 LSB
	Operating temperature	See specification of the respective sensor
	Protection	Reverse polarity, short circuit
	Dielectric strength	1 kV (V AC, 50 Hz, 1 min.)
	EMC	EN 61326-1:2013

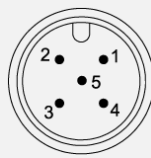
Signal wiring	Signal	Connector pin no.	View to the sensor connector
	Shield	1	
	Excitation +	2	
	GND	3	
	CAN-H	4	
	CAN-L	5	

Magnetic encoder, digital output CAN SAE J1939

MCANJ1939/R CAN SAE J1939 	CAN Specification	ISO 11898, Basic and Full CAN 2.0 B
	Transceiver	24V-compliant, not isolated
	Communication profile	SAE J1939
	Baud Rate	250 kbit/s
	Internal termination resistor	120 Ω adjustable by the customer
	Address	Default 247d, configurable

NAME Fields	Arbitrary address capable	1	Yes
	Industry group	0	Global
	Vehicle system	7Fh (127d)	Non specific
	Vehicle system instance	0	
	Function	FFh (255d)	Non specific
	Function instance	0	
	ECU instance	0	
	Manufacturer	145h (325d)	Manufacturer ID
	Identity number	0nnn	Serial number 21 bit

Parameter Group Numbers (PGN)	Configuration data	PGN EF00h	Proprietary-A (PDU1 peer-to-peer)
	Process data	PGN FFnnh	Proprietary-B (PDU2 broadcast); nn Group Extension (PS) configurable

Specifications	Excitation voltage	8 ... 36 V DC
	Excitation current	20 mA typical at 24 V DC 40 mA typical at 12 V DC, max. 80 mA
	Measuring rate	1 kHz (asynchronous)
	Stability (temperature)	±50 x 10 ⁻⁶ /°C f.s. (typical)
	Repeatability	1 LSB
	Operating temperature	See specification of the respective sensor
	Protection	Reverse polarity, short circuit
	Dielectric strength	1 kV (V AC, 50 Hz, 1 min.)
EMV	EN 61326-1:2013	

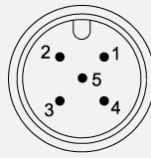
Signal wiring	Signal	Connector pin no.	View to the sensor connector
	Shield	1	
	Excitation +	2	
	GND	3	
	CAN-H	4	
	CAN-L	5	

Absolute encoder outputs

Signal conditioner HSSI

Absolute encoder synchronous serial 	Excitation voltage	10 ... 30 V DC
	Excitation current	100 mA
	Interface	Standard-SSI
	Lines / drivers	Clock and data / RS422
	Code	Gray
	Resolution	12 + 12 bit
	3 dB cutoff frequency	500 kHz
	Control input	$\overline{\text{DIRECTION}}$
	Preset key	Zero adjustment with optical response
	Alarm output	Alarm bit (SSI option), warning bit
	Status LED	Green = OK, red = alarm
Connection	12 pin male socket	

Data format (Mx = Multiturn bits, Sx = Singleturn bits)

Resolution	Clock													
	T1	T2	T3	...	T12	T13	...	T21	T22	T23	T24	T25	T26	
	Data bits													
24 Bit	M11	M10	M09	...	M0	S11	...	S3	S2	S1	S0	0		

Transmission rate

Cable length	Baud rate	Note: Extension of the cable length will reduce the maximum transmission rate.
< 50 m	< 400 kHz	
< 100 m	< 300 kHz	
< 200 m	< 200 kHz	
< 400 m	< 100 kHz	

Signal wiring

Signal	Connector pin no.	Cable color	View to sensor connector
Excitation +	8	white	 CONN-CONIN-12F
Excitation GND	1	brown	
CLOCK	3	yellow	
$\overline{\text{CLOCK}}$	11	green	
DATA	2	pink	
$\overline{\text{DATA}}$	10	grey	
Direction*	5	blue	
0 V Signal output	12	black	

* unconnected or Excitation + = cw increasing code, 0 V = cw decreasing code

Interface HINT

Absolute encoder Interbus 	Excitation voltage	10 ... 30 V DC
	Excitation current	250 mA
	Interface	Interbus, ENCOM profile K3 (configurable), K2
	Output code	32 Bit binary
	Baud rate	500 kBaud
	Data refresh	Every 600 µs
	Resoution	12 (10 ... 14) + 12 bit
	Programmability	Direction, preset, offset, resolution
	Connection	Bus cover with T manifold
	EMC	DIN EN 61326-1:2013

Data format K2 / K3

	Differential signals (RS485) ENCOM profile K3, K2, 32 Bit, binary process data				
DÜ-Format	Süpi-Adresse	0	1	2	3
(according to the Phoenix company)	Byte no.	3	2	1	0
ID-Code K2	36H (=54 dez.)				
ID-Code K3	37H (=55 dez.)				

Signal wiring

Signal	Cable terminal no. (bus cover)
U _b +	1
GND	2
DI1	4
$\overline{DI1}$	6
D01	3
$\overline{D01}$	5
D02	7
$\overline{D02}$	8
DI2	9
$\overline{D02}$	10
RBST	11
GND	12

Interface HPROF

Absolute encoder Profibus 	Excitation voltage	10 ... 30 V DC
	Excitation current	250 mA
	Interface	RS485
	Protocol	Profibus DP with encoder profile C2
	Resolution	12 (10 ... 14) + 12 bit
	Output code	Binary
	Baud rate	Automatically selected between 9,6 kBaud and 12 MBaud
	Programmability	Resolution, preset, direction
	Integrated special functions	Velocity, acceleration, operating time
	Bus terminating resistor	Selectable via DIP switch
	Connection	Bus cover with T manifold
	EMC	Din EN 61326: Class A

Signal wiring

Signal	Cable terminal no. (bus cover)
U _b in	1
0 V in	2
U _B out	3
0 V out	4
B in	5
A in	6
B out	7
A out	8

Interface HDEV

Absolute encoder DeviceNet 	Excitation voltage	10 ... 30 V DC
	Excitation current	250 mA
	Interface	CAN highspeed according to ISO/DIS 11898 CAN specification 2.0 A (11 bit identifier)
	Protocol	DeviceNet according rev. 2.0, programmable encoder
	Resolution	12 (10 ... 14) + 12 bit
	Output code	Binary
	MAC-ID	Selectable via DIP switch
	Date refresh	Every 5 ms
	Baud rate	Selectable via DIP switch: 125 kBaud, 250 kBaud, 500 kBaud
	Programmability	Resolution, preset, direction
	Bus terminating resistor	Selectable via DIP switch
	Connection	Bus cover with T manifold
	EMC	DIN EN 61326-1:2013

Recommended transmission

Characteristic impedance	135 ... 165 Ω (3 ... 20 MHz)
Operating capacity	< 30 pF
Loop resistance	< 110 Ω/km
Wire diameter	> 0.63 mm
Wire width	> 0.34 mm ²

Transmission rate

Segment length	Kbit/s
500 m	125
250 m	250
100 m	500

Signal wiring

Signal	Cable terminal no. (bus cover)
U _b in	1
0 V in	2
CAN-L	4
CAN-H	6
Drain	3
Drain	5
CAN-H	7
CAN-L	8

Interface HCAN / HCANOP

Absolute encoder CANopen / CAN Layer 2 	Excitation voltage	10 ... 30 V DC
	Excitation current	250 mA
	Interface	CAN highspeed according to ISO/DIS 11898
	Protocol	CANopen according DS301 with encoder profile DSP406, programmable encoder according class C2
	Resolution	12 (10 ... 14) + 12 bit
	Output code	Binary
	Data refresh	Every millisecond (selectable), on request
	Baud rate	Selectable 10 up to 1000 kbit/s
	Base identifier	Selectable via DIP switch
	Programmability	CANopen: direction, resolution, preset, offset CAN L2: direction, limit values
	Integrated special functions	CANopen: velocity, acceleration, rotary axis, limit values CAN L2: direction, limit values
	Connection	Bus cover with T manifold
	EMC	DIN EN 61326-1:2013

Signal wiring

Signal	Cable terminal no. (bus cover)
U _b in	1
0 V in	2
CAN in – (dominant L)	4
CAN in + (dominant H)	6
CAN GND in	3
CAN GND out	5
CAN out + (dominant H)	7
CAN out – (dominant L)	8
0 V out	9
U _b out	10

Incremental outputs

Signal conditioner LD5VC

Incremental 	Excitation voltage	5 V DC ±10 %
	Excitation current	150 mA max. w/o load
	Interface	Line driver RS422
	Output frequency	300 kHz max.
	Output current	20 mA per channel
	Signal level	
	U _d High bei I _d = 20 mA	≥ 2.5 V
	U _d Low bei I _d = 20 mA	≥ 0.5 V
	Transition time positive edge	< 100 ns
	Transition time negative edge	< 100 ns
	Stability (temperature)	±20 x 10 ⁻⁶ / °C f.s. (sensor-mechanism)
	Operation temperature	-20 ... +85 °C
	Protection	Short circuit, overvoltage
	EMC	DIN EN 61326-1:2013

Signal wiring

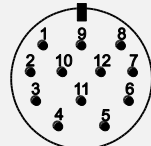
Signal	Connector pin no.	View to sensor connector
Excitation +	12	
Excitation GND	10	
Signal A	5	
Signal \bar{A}	6	
Signal B (A + 90°)	8	
Signal \bar{B}	1	
Signal Z (reference pulse)	3	
Signal \bar{Z}	4	
Fault detection signal	7	
Schirm	housing	

CONN-CONIN-12F

Recommended processing circuit

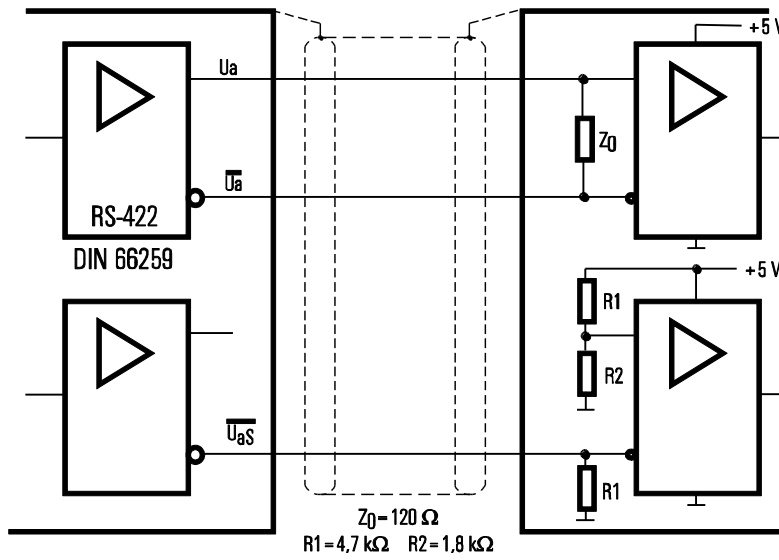

Output signals

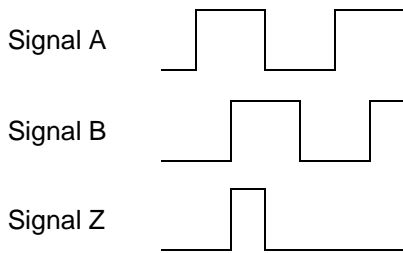

Signal conditioner PP24VC

Incremental 	Excitation voltage	10 ... 30 V DC
	Excitation current	150 mA max. w/o load
	Interface	Push-pull line driver (24 V-HTL)
	Output frequency	300 kHz max.
	Output current	100 mA per channel
	Signal level	
	Ud High at Id = 20 mA, Ub = 24 V	≥ 21 V
	Ud Low at Id = 20 mA, Ub = 24 V	≥ 2.8 V
	Transition time positive edge	< 200 ns
	Transition time negative edge	< 200 ns
	Stability (temperature)	±20 x 10 ⁻⁶ / °C f.s. (sensor mechanism)
	Operating temperature	Refer to output specification
	Protection	Reverse polarity, short circuit, overvoltage
	EMC	DIN EN 61326-1:2013

Signal wiring

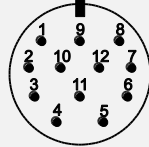
Signal	Connector pin no.	View to sensor connector
Excitation +	12	 <p>CONN-CONIN-12F</p>
Excitation GND	10	
Signal A	5	
Signal \bar{A}	6	
Signal B (A + 90°)	8	
Signal \bar{B}	1	
Signal Z (reference pulse)	3	
Signal \bar{Z}	4	
Fault detection signal	7	
Shield	housing	

Recommended circuit

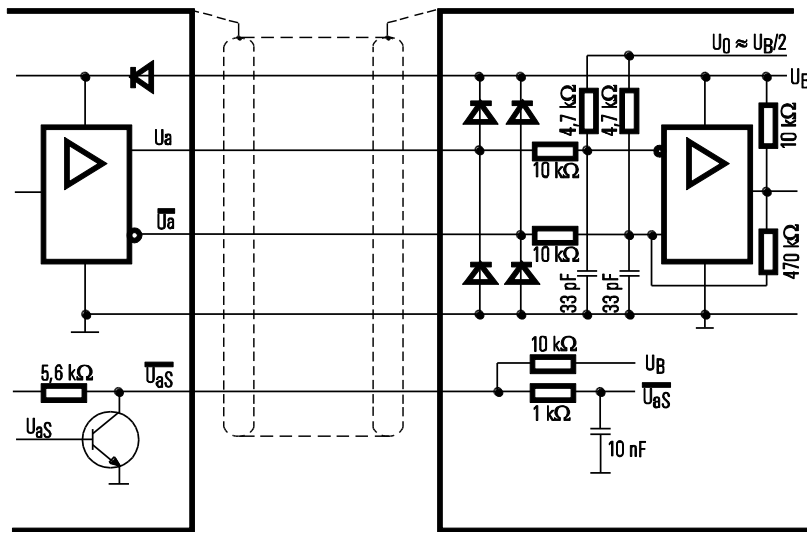

Output signals

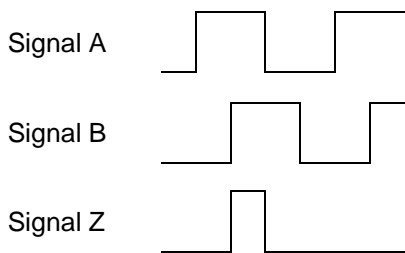

Accessories

Connector cable M12, 4 pin

(angular coupling)

shielded connector

Suitable for 5-pin sensor connectors

The 4-core screened cable is supplied with a mating 4-pin 90° M12 connector at one end and 4 wires at the other end. Available lengths are 2 m, 5 m and 10 m. Wire: cross sectional area 0.34 mm² Cable diameter: 5.6 ±0.2 mm

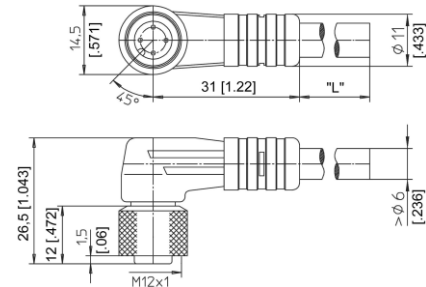

Order code

KAB - xM - M12/4F/W - LITZE

IP69: **KAB - xM - M12/4F/W/69K - LITZE**

xM = length in m

Connector cable M12, 4 pin

(straight coupling)

shielded connector

Suitable for 5-pin sensor connectors

The 4-core screened cable is supplied with a mating 4-pin M12 connector at one end and 4 wires at the other end. Available lengths are 2 m, 5 m and 10 m. Wire: cross sectional area 0.34 mm² Cable diameter: 5.6 ±0.2 mm

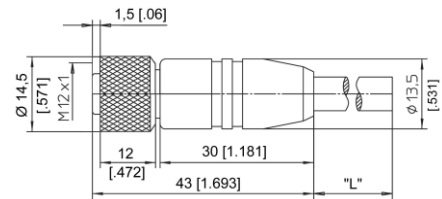

Order code

KAB - xM - M12/4F/G - LITZE

IP69: **KAB - xM - M12/4F/G/69K - LITZE**

xM = length in m

Signal wiring M12, 4 pin	Plug connection / cable color			
	1	2	3	4
	brown	white	blue	black

Applicable for cable carriers

Maximum movement speed	3 m/s
Maximum acceleration	5 m/s ²
Minimum bending radius	10 x cable diameter

**Connector cable M12, 5 pin
(angular coupling)**

shielded connector

The 5-core screened cable is supplied with a mating 5-pin 90° M12 connector at one end and 4 wires at the other end. Available lengths are 2 m, 5 m and 10 m.
Wire: cross sectional area 0.34 mm²
Cable diameter: 5.6 ±0.2 mm

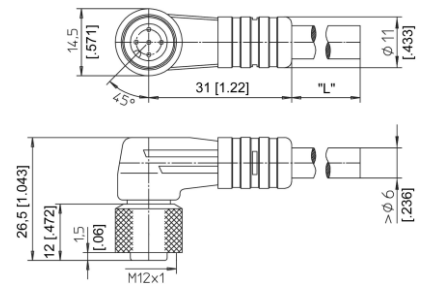

Order code

KAB - xM - M12/5F/W - LITZE

IP69: **KAB - xM - M12/5F/W/69K - LITZE**

xM = length in m

**Connector cable M12, 5 pin
(straight coupling)**

shielded connector

The 5-core screened cable is supplied with a mating 5-pin M12 connector at one end and 4 wires at the other end. Available lengths are 2 m, 5 m and 10 m.
Wire: cross sectional area 0.34 mm²
Cable diameter: 5.6 ±0.2 mm

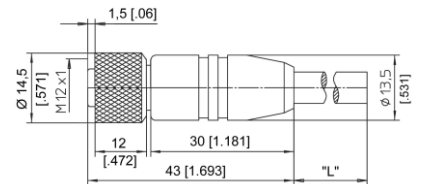

Order code

KAB - xM - M12/5F/G - LITZE

IP69: **KAB - xM - M12/5F/G/69K - LITZE**

xM = length in m

Signal wiring M12, 5 pin	Plug connection / Cable color				
	1	2	3	4	5
	brown	white	blue	black	grey

Applicable for cable carriers

Maximum movement speed	3 m/s
Maximum acceleration	5 m/s ²
Minimum bending radius	10 x cable diameter

**Connector cable M12, 8 pin
(angular coupling)**

shielded connector

The 8-lead shielded cable is supplied with a mating 8-pin 90° M12 connector at one end and 8 wires at the other end. Available lengths are 2 m, 5 m and 10 m. Wire: cross sectional area 0.25 mm² Cable diameter: 6.3 ±0.2 mm

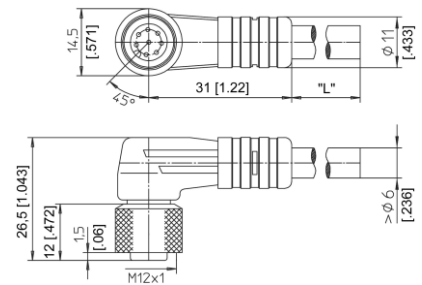

Order code

KAB - xM - M12/8F/W - LITZE

IP69: **KAB - xM - M12/8F/W/69K - LITZE**

xM = length in m

**Connector cable M12, 8 pin
(straight coupling)**

shielded connector

The 8-lead shielded cable is supplied with a mating 8-pin M12 connector at one end and 8 wires at the other end. Available lengths are 2 m, 5 m and 10 m. Wire: cross sectional area 0.25 mm² Cable diameter: 6.3 ±0.2 mm

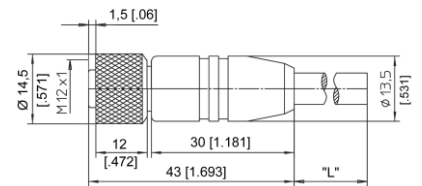

Order code

KAB - xM - M12/8F/G - LITZE

IP69: **KAB - xM - M12/8F/G/69K - LITZE**

xM = length in m

Signal wiring M12, 8 pin	Plug connection / cable color							
	1	2	3	4	5	6	7	8
	white	brown	green	yellow	grey	pink	blue	red

Applicable for cable carriers

Maximum movement speed	3 m/s
Maximum acceleration	5 m/s ²
Minimum bending radius	10 x cable diameter

Connector/bus cable M12, 5 pin CAN-Bus

The 5-lead shielded cable is supplied with a female 5 pin M12 connector at one end and a male 5 pin M12 connector at the other end.

Available lengths are 0.3 m, 2 m, 5 and 10 m.

Cable diameter: 6.7 ±0.2 mm

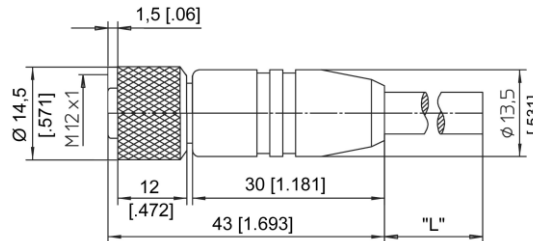

Order code

KAB - xM - M12/5F/G - M12/5M/G - CAN

IP69: **KAB - xM - M12/5F/G/69K - M12/5M/G/69K - CAN**

xM = length in m

T-connector for bus cable M12, 5 pin CAN-Bus

Order code

KAB - TCONN - M12/5M - 2M12/5F - CAN



Terminating resistor M12, 5 pin CAN-Bus

Order code

KAB - RTERM - M12/5M/G - CAN



Applicable for cable carriers

Maximum movement speed	3 m/s
Maximum acceleration	5 m/s ²
Minimum bending radius	10 x cable diameter

Plug-in connectors

Plug-in connector M12, 8 pin (straight coupling)

Order code:

CONN-M12-8F-G

Cable diameter
max. 6 ... 8 mm

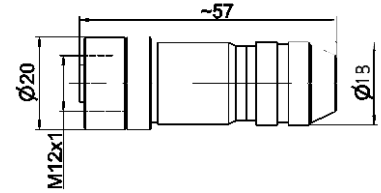

Plug-in connector CONIN, 12 pin (straight coupling)

Order code:

CONN-CONIN-12F-G

Cable diameter
max. 6 ... 8 mm

