

Water-proof Radial Cylinder

ROBO CYLINDER® RCP4W-RA series

# RCP4W-RA

**ROBO  
CYLINDER**



# Introducing the IP67 Water-proof Radial Cylinder– the Newest Addition to the Dust-proof/ Splash-proof ROBO Cylinder RCP4W Series

## Features

### 1 Dust-proof/Splash-proof Performance of IP67

The RCP4W rod type adopts a splash-proof structure to shut out water even when the cylinder is submerged in water, for use in food preparation machines, washing machines and other systems exposed to water splashes and jets.

#### IP Marking

IP

##### First digit

Protection against the human body and solid objects

##### Second digit

Protection against the intrusion of water

#### In-house Test Methods Conforming to JIS C0920

##### In-house Test Methods against Solid Objects

Operate the product for 12 hours in floating talc powder (grain size: 25 μm)

**Results** Powder did not enter the product.

##### In-house Test Method against Water

Submerge the product in water and kept it 1m below the water surface for 30 minutes.

**Results** Water did not enter the product.



**NOTE:** The splash-proof performance has been measured only with regard to water. Protection against coolant, cleaning solution, etc., is not guaranteed. If you wish to use your product in an environment where it may come in contact with coolant, consult IAI beforehand.

#### IP Classes

High	IP class	Description	Applicable IAI products	
↑ Environmental Resistance ↓	IP67	Solid objects	Fully protected against the entry of powder dust into the equipment.	Rod type RCP4W Slider type RCP2W-SA16C
		Water	Even when the equipment is submerged in water, water does not enter the equipment.	
	IP65	Solid objects	Fully protected against the entry of powder dust into the equipment.	Slider type RCP4W Slider type ISWA/ISPWA Pulse motor rod type RCP2W-RA4C/RA6C SCARA robot IX-NNW
		Water	The equipment receives no harmful effect even when directly hit by water jets from any direction.	
	IP54	Solid objects	Dust that would affect the operation of the equipment does not enter the equipment.	High-thrust rod type RCP2W-RA10C 24-V servo motor rod type RCAW-RA3/RA4 200-V servo motor rod type RCS2W-RA4
		Water	The equipment receives no harmful effect even when contacted by water splashes from any direction.	
	IP50	Solid objects	Dust that would affect the operation of the equipment does not enter the equipment.	Small gripper (dust-proof type) RCP2W-GR
		Water	The equipment is not protected against water.	
Low				

2

## Built-in Guide to Achieve Longer Strokes While Accommodating a Radial Load on the Rod

A ball-circulating linear guide is built into the actuator to achieve longer strokes of up to 500 mm. The guide also accommodates a load offset from the rod center (by up to 100 mm), which expands the degree of freedom in transfer applications.

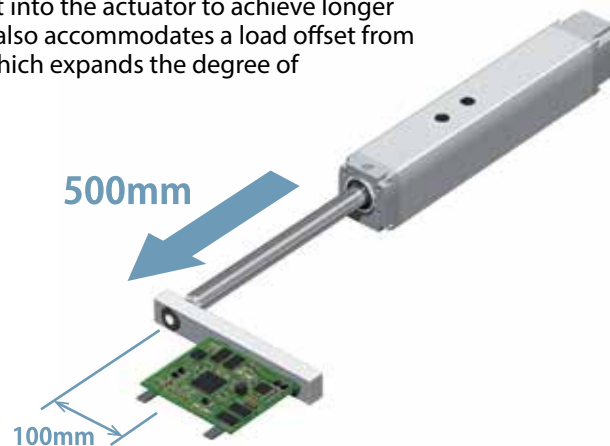

3

## High Speed and High Acceleration/Deceleration

The RCP4W boasts the maximum acceleration/deceleration of 1 G and maximum speed of 560 mm/s, which are approx. 1.6 times the maximum acceleration/deceleration and maximum speed of any conventional splash-proof rod type, enabling a shorter cycle time for your system.

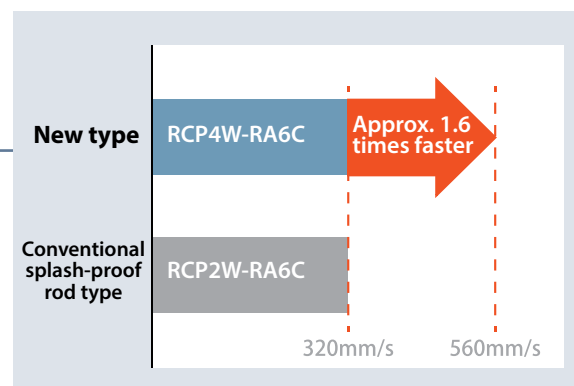

4

## Improved Maintainability

The ball screw and guide can be lubricated at the same time by adding grease from the grease nipples provided on the top face of the nut holder. Another grease nipple is provided on the top face of the front bracket to grease the sliding part of the rod.

Replacing the seals at the sliding part of the rod is very easy, because all you need is to change the front bracket.

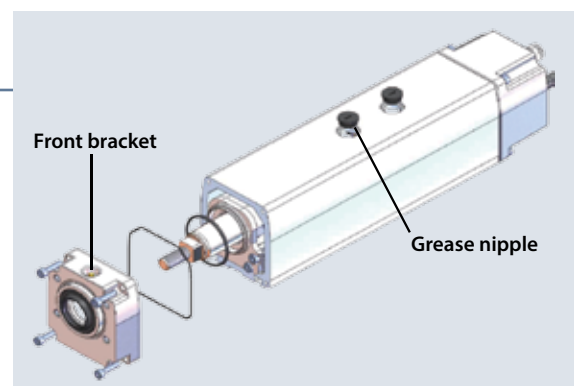

## Specification Table

Type	External view	Actuator size (mm)	Stroke (mm)	Ball screw lead (mm)	Maximum speed (mm/s) (*1)	Payload (kg)		Maximum Push Force (N)	Reference page
						Horizontal	Vertical		
RA6C			50~400 (Every 50)	12	560 <500>	20	3	93	P5
				6	360	40	8	185	
				3	180	50	16	370	
					70	-	30	590	
RA7C			50~500 (Every 50)	16	560 <400>	40	7	219	P7
				8	340 <280>	50	15	437	
				4	170 <140>	70	25	875	
					80	-	45	1030	

(\*1) The values in <> apply when the actuator is used vertically.

## Model Number

### Actuator

**RCP4W** -  -  -  -  -  -  -  -  -

Series      Type code      Encoder type      Motor type      Ball screw lead      Stroke (mm)      Applicable controller      Cable length      Options

<b>RA6C</b>	Actuator width 65mm	<b>i</b>	Incremental	<b>3</b>	Lead 3	<b>P3</b>	PCON-CA	<b>A1</b>	Cable exit from the left
<b>RA7C</b>	Actuator width 75mm			<b>4</b>	Lead 4	<b>P4</b>	PCON-CFA	<b>A3</b>	Cable exit from the right
		<b>42P</b>	42□ motor	<b>6</b>	Lead 6	<b>N</b>	No cable	<b>AT</b>	Cable exit from the top
		<b>42SP</b>	42□ high-thrust motor	<b>8</b>	Lead 8	<b>P</b>	1 m	<b>B</b>	Brake
		<b>56P</b>	56□ motor	<b>12</b>	Lead 12	<b>S</b>	3 m	<b>FL</b>	With flange
		<b>56SP</b>	56□ high-thrust motor	<b>16</b>	Lead 16	<b>M</b>	5 m	<b>FT</b>	With foot bracket
				<b>50</b>	50mm	<b>X□□</b>	Specified length	<b>NM</b>	Non-motor side specification
				<b>?</b>	?	<b>R□□</b>	Robot cable		
				<b>500</b>	500mm				

(Can be set in 50-mm increments.)

**NOTE:** The settings for motor type, ball screw lead, stroke and options vary from one model to another. For details, check the specifications for each model.

## Options

### ■ Optional Cable Exit Direction Code: A1, A3, AT

You can select one of the following three cable exit directions. If no direction is specified, the cable exits from the rear.  
\*In the following figures, ( ) and < > refer to RA6 and RA7, respectively. Other than that, it refers to a common dimension.

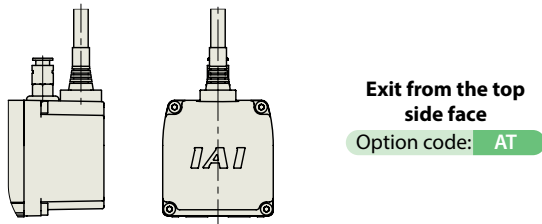
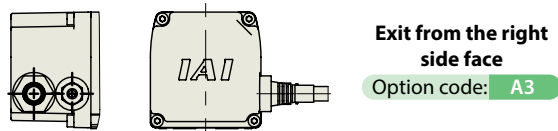
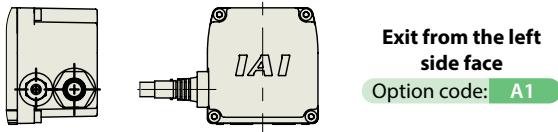
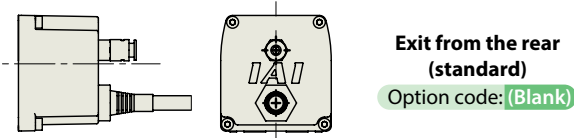

### ■ Brake Option code: B

This option is provided to prevent the rod from dropping upon cutoff of power when the actuator is used vertically.

### ■ Non-motor side Specification Option code: NM

Normally the home position is where the rod is retracted. This option is provided to define the condition where the rod has extended as home.

### ■ With Flange Option code: FL

This flange is used to secure the actuator with bolts from the actuator side.

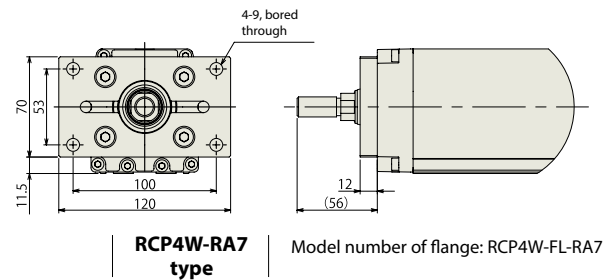
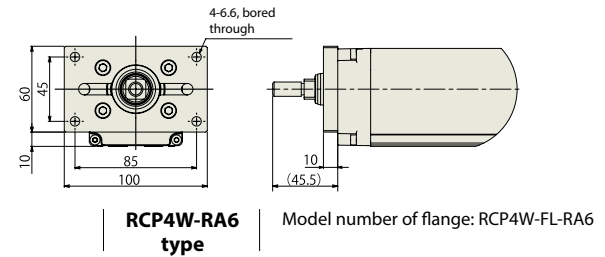

### ■ With Foot Bracket Option code: FT

This bracket is used to secure the actuator with bolts from above.

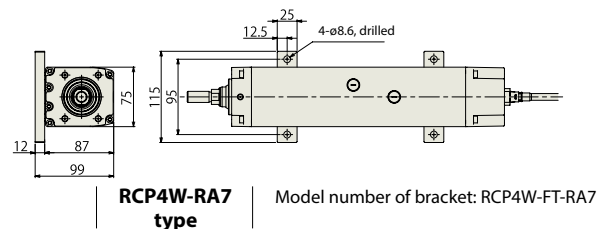
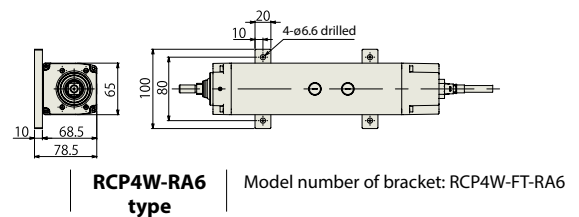

## Spare Parts

As a rough guide, replace the scraper (front bracket assembly) after every 1,000 km of traveling or 1 year of use. When replacing the scraper, specify the applicable model number in your order as shown below.

No	Name	Model Number		Order unit
		RA6	RA7	
1	Front bracket assembly	RCP4W-FBA-RA6	RCP4W-FBA-RA7	1
2	O-ring	RCP4W-OR1-RA6	RCP4W-OR1-RA7	1
3	O-ring	RCP4W-OR2-RA6	RCP4W-OR2-RA7	1
4	Cap	RCP4W-CS-RA		1
5	Bolt	(Supplied with the front bracket assembly)		

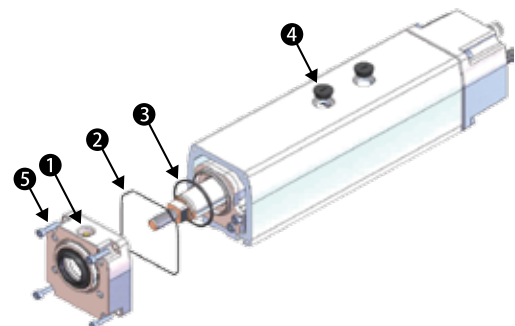



# RCP4W-RA6C

ROBO Cylinder Water-proof rod type  
24-V Pulse motor

Actuator width: 65 mm

Model Specification Items	<b>RCP4W</b> — <b>RA6C</b> — <b>I</b> — <input type="checkbox"/> — <input type="checkbox"/> — <input type="checkbox"/> — <input type="checkbox"/>	<b>P3</b> — <input type="checkbox"/> — <input type="checkbox"/>
	Series — Type — Encoder type — Motor type — Lead — Stroke — Applicable controller — Cable length — Options	
	I: Incremental specification	P3: PCON-CA
	42P: Pulse motor, size 42 <input type="checkbox"/>	N: None
	42SP: High-thrust pulse motor, size 42 <input type="checkbox"/>	P: 1m
	12: 12mm	S: 3m
	6: 6mm	M: 5m
	3: 3mm	X <input type="checkbox"/> : Specified length
	50: 50mm	R <input type="checkbox"/> : Robot cable
	400: 400mm (every 50-mm)	
		Refer to the option list below.
		* If the high-thrust pulse motor is selected, the actuator comes standard with option B (Brake).

Built-in Guide Mechanism

RoHS



- POINT**  
Notes on selection
- (1) The maximum payload is the value when operated horizontally and vertically at 0.3G and 0.5G, respectively. Note that raising the acceleration causes the payload to drop. (Refer to P. 10 for the maximum payload by acceleration.)
  - (2) The horizontal payload is calculated by assuming that an external guide is also used.
  - (3) The high-thrust specification is designed exclusively for vertical operation. It comes standard with a brake.

## Correlation Diagrams of Speed and Payload

Due to its pulse motor characteristics, the RCP4 series provides lower payload at higher speed. Check the tables below to see if the desired speed and payload can be achieved.

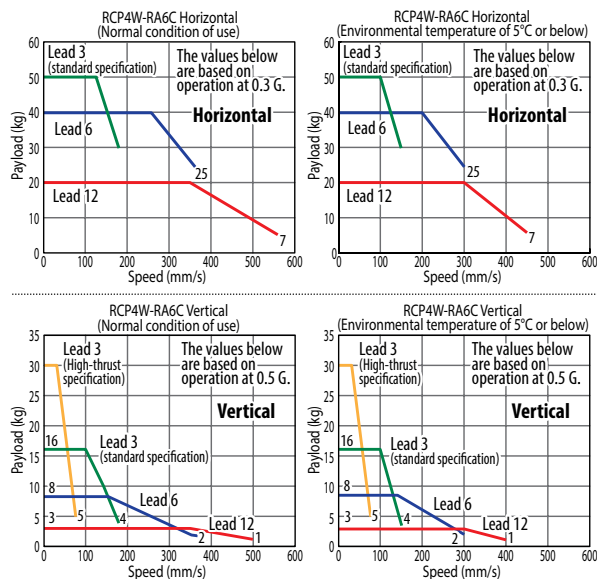

## Actuator Specifications

### Leads and Payloads

Model number	Lead (mm)	Maximum payload (kg)		Maximum push force (N)	Positioning repeatability (mm)	Stroke (mm)
		Horizontal (kg)	Vertical (kg)			
Standard specification	RCP4W-RA6C-I-42P-12-①-P3-②-③	12	20	3	±0.02	50 to 400 (in 50-mm increments)
	RCP4W-RA6C-I-42P-6-①-P3-②-③	6	40	8		
	RCP4W-RA6C-I-42P-3-①-P3-②-③	3	50	16		
High-thrust specification	RCP4W-RA6C-I-42SP-3-①-P3-②-③-B	3	-	30		

Legend ① Stroke ② Cable length ③ Options

### Stroke and Maximum Speed (unit: mm/s)

Stroke / Lead	Maximum Speed (mm/s)	
	50 (mm)	100 ~ 400 (in 50-mm increments)
12	500 [450 <400>]	560 <500> [450 <400>]
6	360 [300]	
3	180 [150]	
3	<70> [<70>]	

\*The values in <> apply when the actuator is used vertically.  
\*The values in [] apply when the actuator is used at an environmental temperature of 5°C or below.

### ① Stroke

Stroke (mm)	Standard price	
	Standard specification	High-thrust specification
50	-	-
100	-	-
150	-	-
200	-	-
250	-	-
300	-	-
350	-	-
400	-	-

### ② Cable length

Type	Cable symbol	Standard price
Standard type	P (1m)	-
	S (3m)	-
	M (5m)	-
Special length	X06 (6m) ~ X10 (10m)	-
	X11 (11m) ~ X15 (15m)	-
	X16 (16m) ~ X20 (20m)	-
	R01 (1m) ~ R03 (3m)	-
Robot cable	R04 (4m) ~ R05 (5m)	-
	R06 (6m) ~ R10 (10m)	-
	R11 (11m) ~ R15 (15m)	-
	R16 (16m) ~ R20 (20m)	-

### ③ Options

Name	Option code	See page	Standard price
Cable exit from the left side face	A1	P4	-
Cable exit from the right side face	A3		-
Cable exit from the top face	AT		-
Brake	B		-
With flange	FL		-
With foot bracket	FT		-
Non-motor side specification	NM		-

\*The high-thrust specification comes standard with a brake.

### Actuator Specifications

Item	Description
Drive system	Ball screw ø10mm, rolled C10
Positioning repeatability	±0.02mm
Lost motion	0.1mm or less
Rod	ø22 stainless steel pipe
Rod non-rotation accuracy	±0.1 deg
Allowable load/allowable torque at end of rod	Refer to the page on the right.
Lost offset distance at end of rod	100mm or less
Protective structure	IP67
Ambient operating temperature, humidity	0 to 40°C, 85% RH or less (Non-condensing)

Offset distance at end of rod (100mm or less)

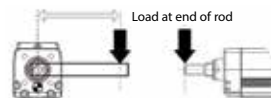

## Dimensional Drawings

CAD drawings can be downloaded from the website. [www.intelligentactuator.com](http://www.intelligentactuator.com)



- \*1 Connect the motor and encoder cables.
- \*2 The rod moves to the ME during home return, so pay attention to possible contact with surrounding structures and objects.
- \*3 The orientation of the width across flats varies from one product to another.
- \*4 When installing the actuator using the front housing or flange, make sure the actuator does not receive any external force

### Materials of Key Components

① Frame	Aluminum extrusion material (A6063SS-T5 or equivalent) with white alumite coating
② Front bracket	Aluminum die-cast
③ Rear cover	Aluminum die-cast
④ Rod	Stainless steel pipe (SUS304 or equivalent), polished + hard chrome plated
⑤ Actuator cable	Polyvinyl chloride (PVC)
⑥ Intake/exhaust port	Polyphenylene sulfide (PPS)

### <Cable Exit Direction Option>

Exit from the top

Option code: **AT**

Exit from the left side face

Option code: **A1**

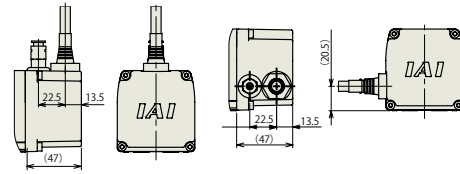

Exit from the right side face

Option code: **A3**

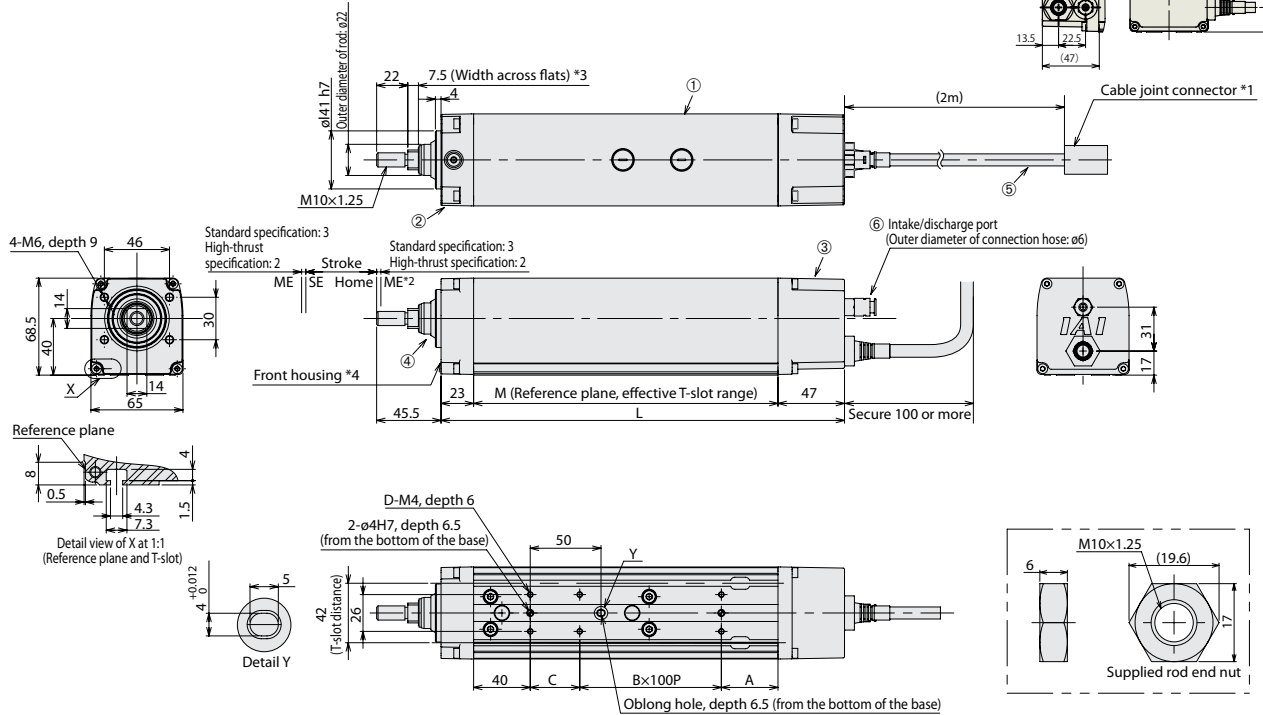
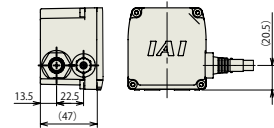

### ■ Rod Deflection of RCP4W-RA6C (Reference Values)

(The graph below plots deflection as measured by installing the actuator vertically and applying a force to the rod from one side.)

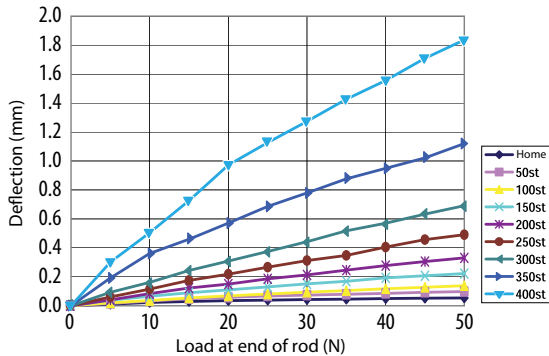

### ■ Dimensions and Mass by Stroke

Stroke	50	100	150	200	250	300	350	400	
L	Without brake	285	335	385	435	485	535	585	635
	With brake (*)	346	396	446	496	546	596	646	696
A	Without brake	40	40	40	40	40	40	40	40
	With brake (*)	101	101	101	101	101	101	101	101
B	1	1	2	2	3	3	4	4	
C	35	85	35	85	35	85	35	85	
D	6	6	8	8	10	10	12	12	
M	Without brake	215	265	315	365	415	465	515	565
	With brake	276	326	376	426	476	526	576	626
Allowable static load at end of rod (N)	Without brake	65.6	51.2	41.7	34.9	29.8	25.7	22.4	19.7
	With brake	32.4	23.6	18.1	14.4	11.6	9.5	7.7	6.2
Allowable dynamic load at end of rod (N)	Load offset 0 mm	25.6	19.7	15.7	12.7	10.4	8.6	7.1	5.7
	Load offset 100 mm	6.6	5.2	4.3	3.7	3.2	2.8	2.6	2.3
Allowable static torque at end of rod (N-m)	Without brake	2.6	2.0	1.6	1.3	1.0	0.9	0.7	0.6
	With brake	2.6	2.0	1.6	1.3	1.0	0.9	0.7	0.6
Mass (kg)	Without brake	3.1	3.5	3.8	4.2	4.6	5.0	5.4	5.8
	With brake	3.6	4.0	4.4	4.8	5.2	5.6	6.0	6.4

(\*) The dimensions of the high-thrust specification include the brake.

### Applicable Controller

RCP4 series actuators can be operated with the controller indicated below. Select the type according to your intended application.

Name	External view	Model number	Features	Maximum number of positioning points	Input Power	Power supply capacity	Standard price	Reference page
Positioner type		PCON-CA-42PI-NP-□-0-□ PCON-CA-42PI-PN-□-0-□	Positioner type based on PIO control	512 points	DC24V	Refer to P. 13	-	Refer to P. 12
Pulse-train type		PCON-CA-42PI-PLN-□-0-□ PCON-CA-42PI-PLP-□-0-□	Pulse-train input type The actuator can be operated freely by pulse-train control.	-				
Field network type		PCON-CA-42PI-O-0-0-□	Supporting 7 major field networks	768 points				

\*In the model numbers shown above, □ indicates the field network specification (DV, CC, PR, CN, ML, EC or EP).

# RCP4W-RA7C

ROBO Cylinder Water-proof rod type  
24-V Pulse motor

Actuator width: 75 mm

Model Specification Items	<b>RCP4W</b> — <b>RA7C</b> — <b>I</b> — <input type="checkbox"/> — <input type="checkbox"/> — <input type="checkbox"/> — <input type="checkbox"/> — <input type="checkbox"/> — <input type="checkbox"/> — <input type="checkbox"/> — <input type="checkbox"/> — <input type="checkbox"/>
	Series — Type — Encoder type — Motor type — Lead — Stroke — Applicable controller — Cable length — Options
	I: Incremental specification 56P: Pulse motor, size 56 <input type="checkbox"/> 56SP: High-thrust pulse motor, size 56 <input type="checkbox"/>
	16: 16mm 8: 8mm 4: 4mm
	50 : 50mm 500 : 500mm (every 50-mm)
	P3:PCON-CFA P4:PCON-CFA *The PCON-CFA is designed exclusively for the high-thrust specification.
	N: None P: 1 m S: 3 m M: 5 m X <input type="checkbox"/> : Specified length R <input type="checkbox"/> : Robot cable
	Refer to the option list below. *If the high-thrust pulse motor is selected, the actuator comes standard with option B (Brake).

Built-in Guide Mechanism

RoHS



- POINT**  
Notes on selection
- (1) The maximum payload is the value when operated horizontally and vertically at 0.3G and 0.5G, respectively. Note that raising the acceleration causes the payload to drop. (Refer to P. 10 for the maximum payload by acceleration.)
  - (2) The horizontal payload is calculated by assuming that an external guide is also used.
  - (3) The high-thrust specification is designed exclusively for vertical operation. It comes standard with a brake.

## Correlation Diagrams of Speed and Payload

Due to its pulse motor characteristics, the RCP4 series provides lower payload at higher speed. Check the tables below to see if the desired speed and payload can be achieved.

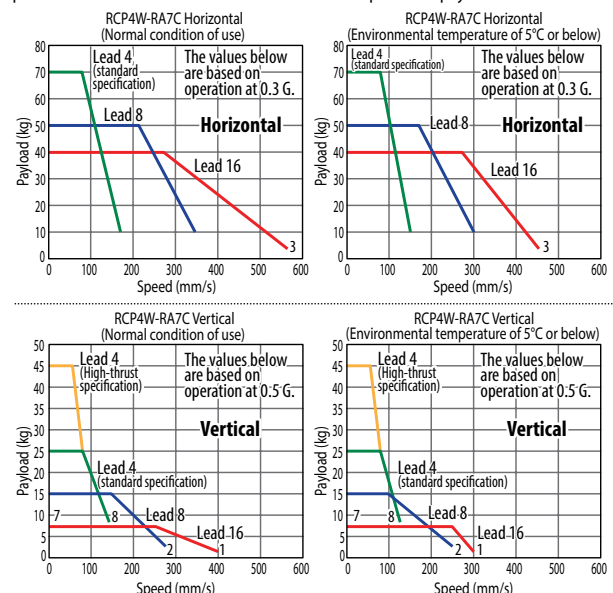

## Actuator Specifications

### Leads and Payloads

Model number	Lead (mm)	Maximum payload (kg)		Maximum push force (N)	Positioning repeatability (mm)	Stroke (mm)
		Horizontal	Vertical			
Standard specification	RCP4W-RA7C-I-56P-16- <input type="checkbox"/> -P3- <input type="checkbox"/> - <input type="checkbox"/>	16	40	7	219	±0.02 50 to 500 (in 50-mm increments)
	RCP4W-RA7C-I-56P-8- <input type="checkbox"/> -P3- <input type="checkbox"/> - <input type="checkbox"/>	8	50	15	437	
	RCP4W-RA7C-I-56P-4- <input type="checkbox"/> -P3- <input type="checkbox"/> - <input type="checkbox"/>	4	70	25	875	
High-thrust specification	RCP4W-RA7C-I-56SP-4- <input type="checkbox"/> -P4- <input type="checkbox"/> - <input type="checkbox"/> -B	4	-	45	1030	

Legend  Stroke  Cable length  Options

### Stroke and Maximum Speed (unit: mm/s)

Stroke / Lead	Maximum speed (mm/s)	
	50 (mm)	100 ~ 500 (in 50-mm increments)
16	500 [450 <300>]	560 <400> [450 <300>]
8	340 <280> [300 <250>]	340 <280> [300 <250>]
4	170 <140> [150 <125>]	170 <140> [150 <125>]
4	<80> [<80>]	<80> [<80>]

\*The values in < > apply when the actuator is used vertically.  
\*The values in [ ] apply when the actuator is used at an environmental temperature of 5°C or below.

### Stroke

Stroke (mm)	Standard price	
	Standard specification	High-thrust specification
50	-	-
100	-	-
150	-	-
200	-	-
250	-	-
300	-	-
350	-	-
400	-	-
450	-	-
500	-	-

### Cable length

Type	Cable symbol	Standard price
Standard type	P (1m)	-
	S (3m)	-
	M (5m)	-
Special length	X06 (6m) ~ X10 (10m)	-
	X11 (11m) ~ X15 (15m)	-
	X16 (16m) ~ X20 (20m)	-
	R01 (1m) ~ R03 (3m)	-
Robot cable	R04 (4m) ~ R05 (5m)	-
	R06 (6m) ~ R10 (10m)	-
	R11 (11m) ~ R15 (15m)	-
	R16 (16m) ~ R20 (20m)	-

### Options

Name	Option code	See page	Standard price
Cable exit from the left side face	A1	P4	-
Cable exit from the right side face	A3		-
Cable exit from the top face	AT		-
Brake	B		-
With flange	FL		-
With foot bracket	FT		-
Non-motor side specification	NM		-

\*The high-thrust specification comes standard with a brake.

### Actuator Specifications

Item	Description
Drive system	Ball screw ø12mm, rolled C10
Positioning repeatability	±0.02mm
Lost motion	0.1mm or less
Rod	ø25 stainless steel pipe
Rod non-rotation accuracy	±0.1 deg
Allowable load/allowable torque at end of rod	Refer to the page on the right.
Lost offset distance at end of rod	100mm or less
Protective structure	IP67
Ambient operating temperature, humidity	0 to 40°C, 85% RH or less (Non-condensing)

Offset distance at end of rod (100mm or less) Load at end of rod

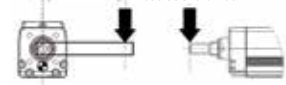



## Dimensional Drawings

CAD drawings can be downloaded from the website. [www.intelligentactuator.com](http://www.intelligentactuator.com)



- \*1 Connect the motor and encoder cables.
- \*2 The rod moves to the ME during home return, so pay attention to possible contact with surrounding structures and objects.
- \*3 The orientation of the width across flats varies from one product to another.
- \*4 When installing the actuator using the front housing or flange, make sure the actuator does not receive any external force

### Materials of Key Components

①	Frame	Aluminum extrusion material (A6063S5-T5 or equivalent) with white alumite coating
②	Front bracket	Aluminum die-cast
③	Rear cover	Aluminum die-cast
④	Rod	Stainless steel pipe (SUS304 or equivalent), polished + hard chrome plated
⑤	Actuator cable	Polyvinyl chloride (PVC)
⑥	Intake/exhaust port	Polyphenylene sulfide (PPS)

### <Cable Exit Direction Option>

Exit from the top  
Option code: **AT**

Exit from the left side face  
Option code: **A1**

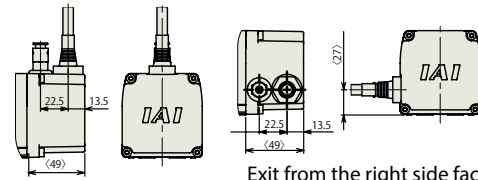

Exit from the right side face  
Option code: **A3**

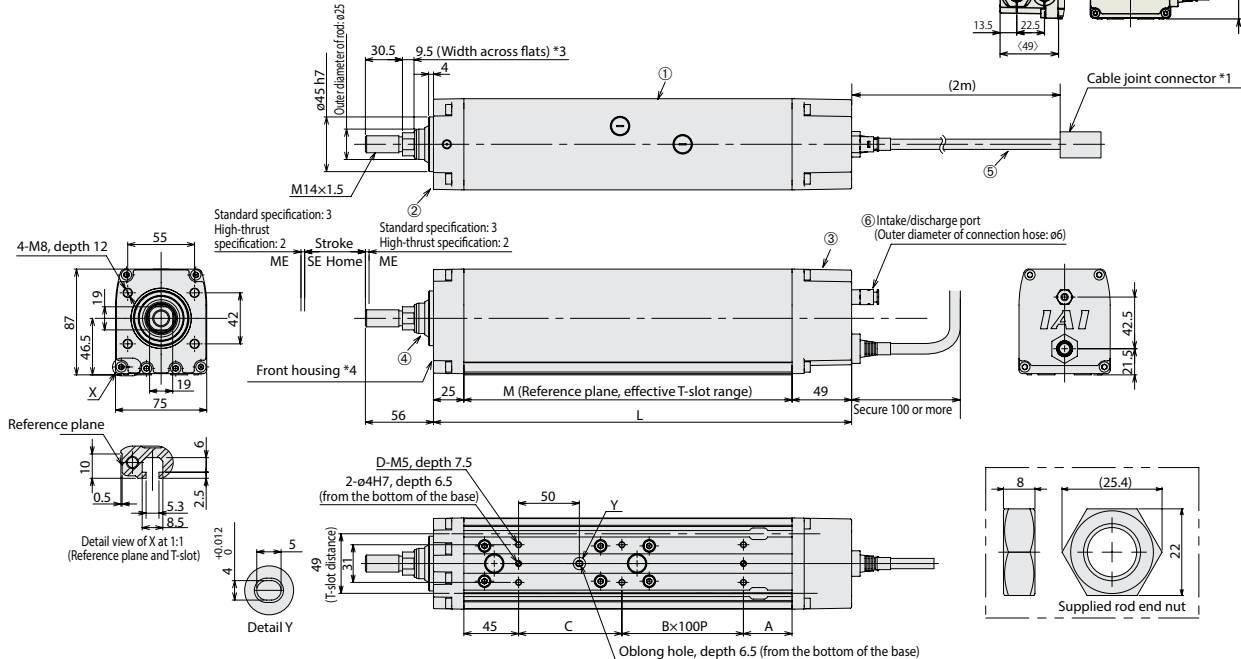
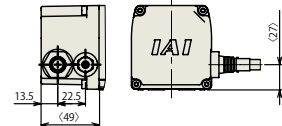

### ■ Rod Deflection of RCP4W-RA7C (Reference Values)

(The graph below plots deflection as measured by installing the actuator vertically and applying a force to the rod from one side.)

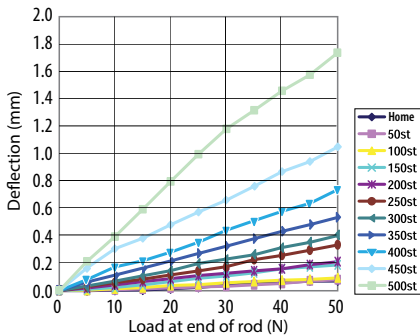

### ■ Dimensions and Mass by Stroke

		Stroke	50	100	150	200	250	300	350	400	450	500
L	Without brake	344	394	444	494	544	594	644	694	744	794	
	With brake (*)	399	449	499	549	599	649	699	749	799	849	
A	Without brake	40	40	40	40	40	40	40	40	40	40	
	With brake (*)	95	95	95	95	95	95	95	95	95	95	
B		1	1	2	2	3	3	4	4	5	5	
C		85	135	85	135	85	135	85	135	85	135	
D		6	6	8	8	10	10	12	12	14	14	
M	Without brake	270	320	370	420	470	520	570	620	670	720	
	With brake	325	375	425	475	525	575	625	675	725	775	
Allowable static load at end of rod (N)		112.7	91.5	76.7	65.7	57.2	50.4	44.8	40.2	36.2	32.7	
Allowable dynamic load at end of rod (N)	Load offset 0 mm	49.0	37.4	29.9	24.5	20.4	17.1	14.5	12.3	10.3	8.6	
	Load offset 100 mm	38.7	31.0	25.5	21.4	18.1	15.4	13.2	11.2	9.5	8.0	
Allowable static torque at end of rod (N·m)		11.4	9.3	7.9	6.8	6.0	5.4	4.9	4.5	4.1	3.8	
Allowable dynamic torque at end of rod (N·m)		3.9	3.1	2.5	2.1	1.8	1.5	1.3	1.1	1.0	0.8	
Mass (kg)	Without brake	5.6	6.1	6.6	7.2	7.7	8.2	8.7	9.2	9.7	10.2	
	With brake	6.4	6.9	7.4	7.9	8.4	9.0	9.5	10.0	10.5	11.0	

(\*) The dimensions of the high-thrust specification include the brake.

### Applicable Controller

RCP4 series actuators can be operated with the controller indicated below. Select the type according to your intended application.

Name	External view	Model number	Features	Maximum number of positioning points	Input Power	Power supply capacity	Standard price	Reference page
Positioner type		PCON-CA-56PI-NP-□-0-□ PCON-CA-56PI-PN-□-0-□	Positioner type based on PIO control	512 points	DC24V	Refer to P. 13	-	Refer to P. 12
Pulse-train type		PCON-CA-56PI-PLN-□-0-□ PCON-CA-56PI-PLP-□-0-□	Pulse-train input type The actuator can be operated freely by pulse-train control.	-				
Field network type	PCON-CA-56PI-○-0-0-□	Supporting 7 major field networks	768 points					
Positioner type		PCON-CFA-56SPI-NP-□-0-□ PCON-CFA-56SPI-PN-□-0-□	High-thrust specification Positioner type based on PIO control	512 points	DC24V	Refer to P. 13	-	Refer to P. 12
Pulse-train type		PCON-CFA-56SPI-PLN-□-0-□ PCON-CFA-56SPI-PLP-□-0-□	High-thrust specification Pulse-train input type	-				
Field network type		PCON-CFA-56SPI-○-0-0-□	High-thrust specification Supporting 7 major field networks	768 points				

\*In the model numbers shown above, ○ indicates the field network specification (DV, CC, PR, CN, ML, EC or EP).

## System Configuration

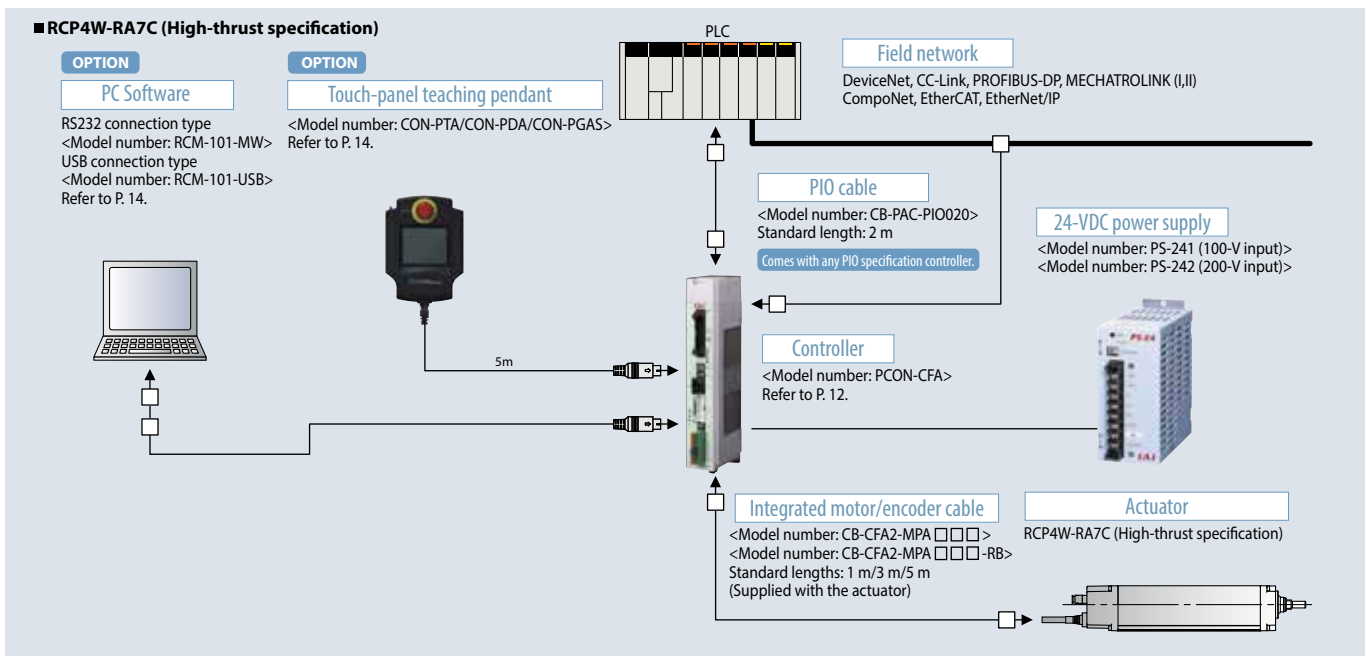
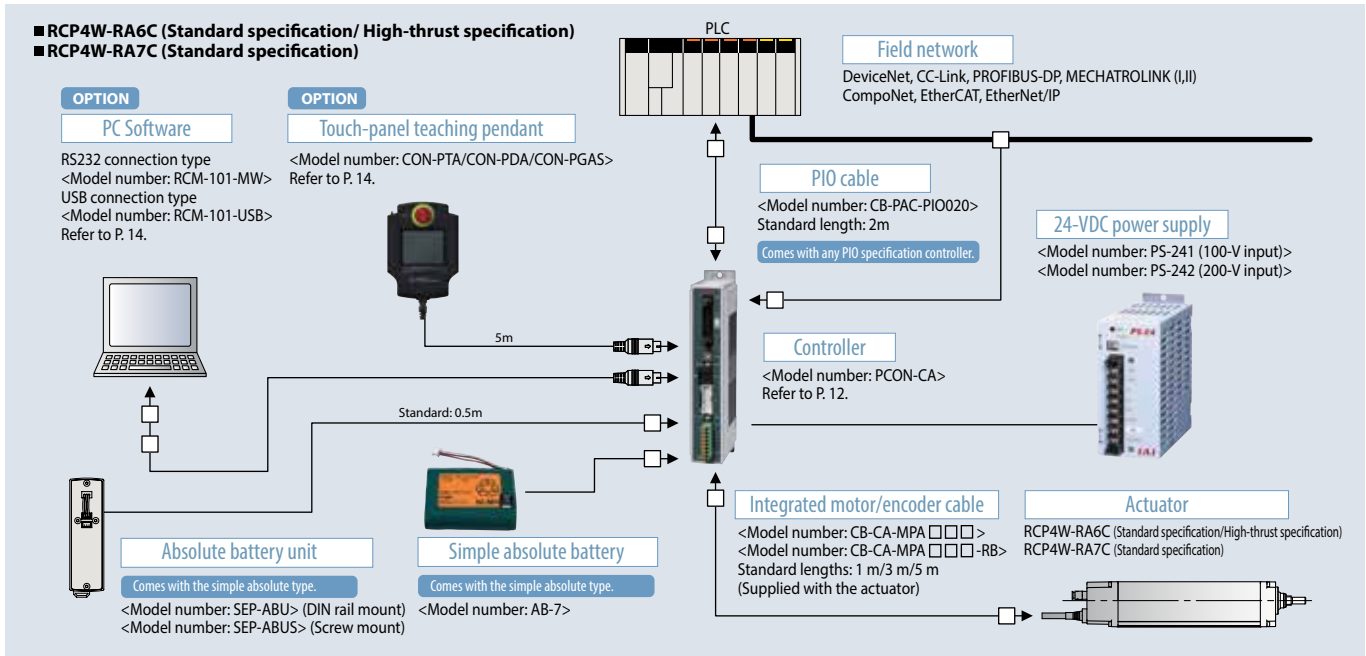

## Notes

1. This actuator conforms to the IP67 standard, but it is not IP67-protected when operated in water. IP67 defines a degree of protection against water, so if the actuator is to be used in an environment where it may come in contact with coolant, etc., contact IAI beforehand.
2. The air joint attached to the motor cover of the actuator is connected to the pipe for bleeding air from the actuator. Connect an air hose of  $\varnothing 6$  in outer diameter and extend the opposite end of the hose to a location free from liquids and powder dust.
3. If the actuator is installed with its rod facing up, be careful not to let any liquid collect in the scraper part of the front bracket.
4. If the environmental temperature is  $5^{\circ}\text{C}$  or below, the speed drops compared to when the actuator is used in normal conditions. For details, refer to the correlation diagram of speed and payload on the page featuring the specifications of each model.

## Payload by Acceleration

(Unit of payload: kg)

	TYPE	Installation direction	Lead	Acceleration (G)			
				0.3	0.5	0.7	1
Payload	RA6C Standard specification	Horizontal	12	20	15	12	10
			6	40	35	25	20
			3	50	45	40	35
		Vertical	12	3	3	-	-
			6	8	8	-	-
			3	16	16	-	-
	RA6C High-thrust specification		3	30	30	-	-
	RA7C Standard specification	Horizontal	16	40	35	30	25
			8	50	45	40	35
			4	70	60	50	45
		Vertical	16	7	7	-	-
			8	15	15	-	-
4			25	25	-	-	
RA7C High-thrust specification		4	45	45	-	-	

## Correlation Diagrams of Push Force and Current-limiting Value

The push force can be adjusted by changing the current-limiting value of the controller. Refer to the graphs below to select a model capable of generating the required push force.

### Note

- The push force varies depending on the slide resistance and also due to aging. Accordingly, the push forces shown in the graphs are a little conservative relative to the current-limiting values. Select a model whose graph shows the desired push force inside the red lines.
- All push forces have been measured at a speed of 20 mm/s. Note that the push force changes when the speed is changed.

### ■ RCP4W-RA6C type

<RA6C, Lead 3, High-thrust specification>

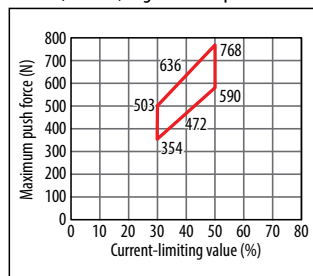

<RA6C, Lead 3, Standard specification>

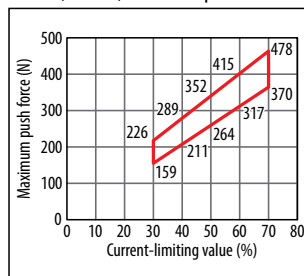

<RA6C, Lead 6, Standard specification>

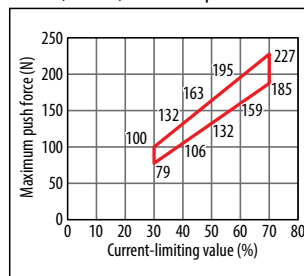

<RA6C, Lead 12, Standard specification>

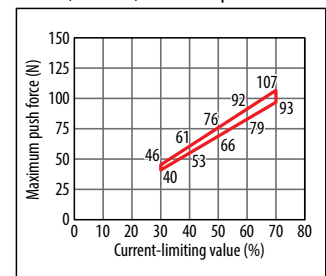

### ■ RCP4W-RA7C type

<RA7C, Lead 4, High-thrust specification>

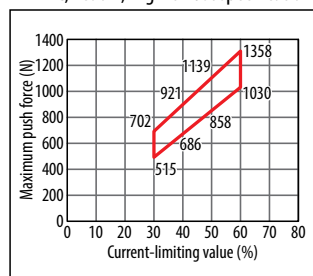

<RA7C, Lead 4, Standard specification>

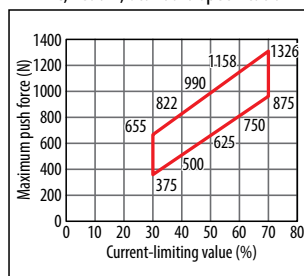

<RA7C, Lead 8, Standard specification>

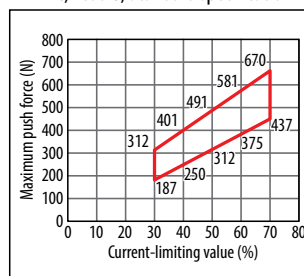

<RA7C, Lead 16, Standard specification>

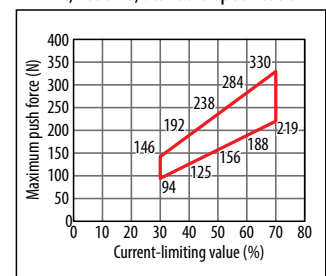

## Selection References (Guide for Selecting Allowable Load for Radial Cylinder)

The RCP4W rod type cylinder has a built-in guide, so loads up to a certain level can be applied to the rod without using an external guide. Refer to the graphs below for the allowable load mass. If the allowable load will be exceeded under the required operating conditions, add an external guide.

### ■ Allowable load mass for RCP4W-RA6C/7C horizontally mounted

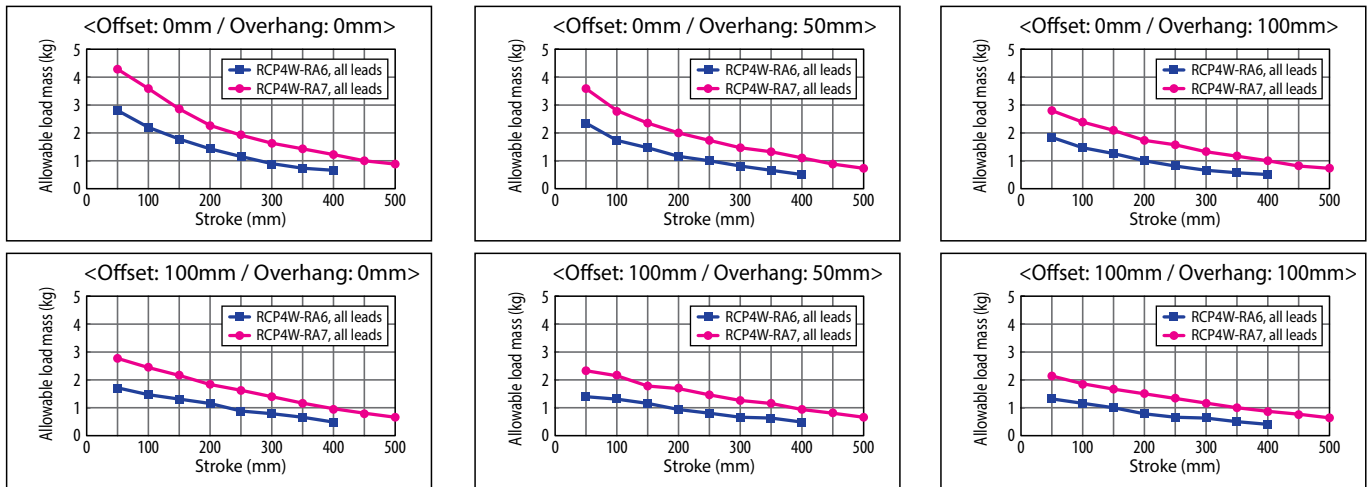
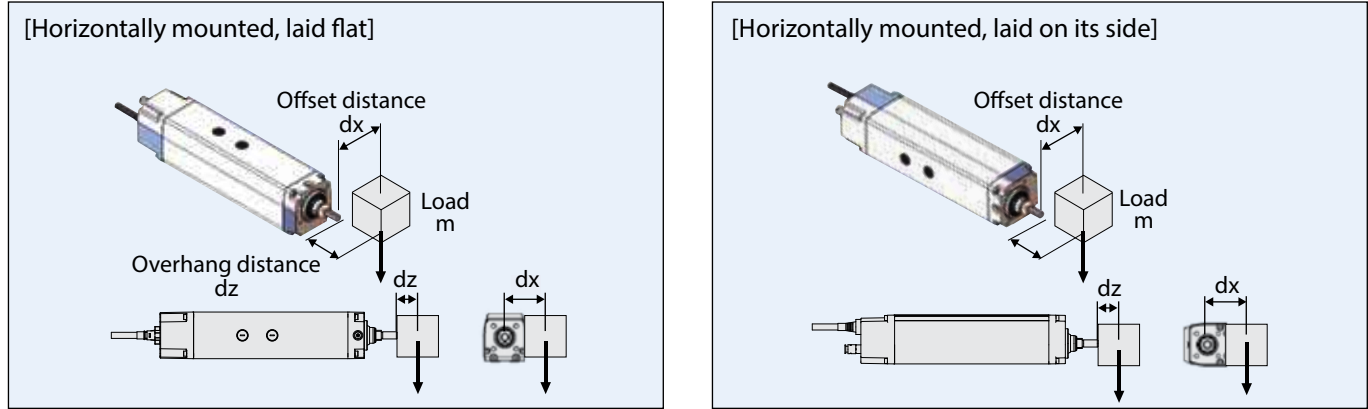

Allowable load calculation conditions: Load mass corresponding to a guide traveling life of 5,000 km, considering moments generated by acceleration/deceleration. (Acceleration: 1 G / Speed: 500 mm/s)

### ■ Allowable load mass for RCP4W-RA6C/7C vertically mounted

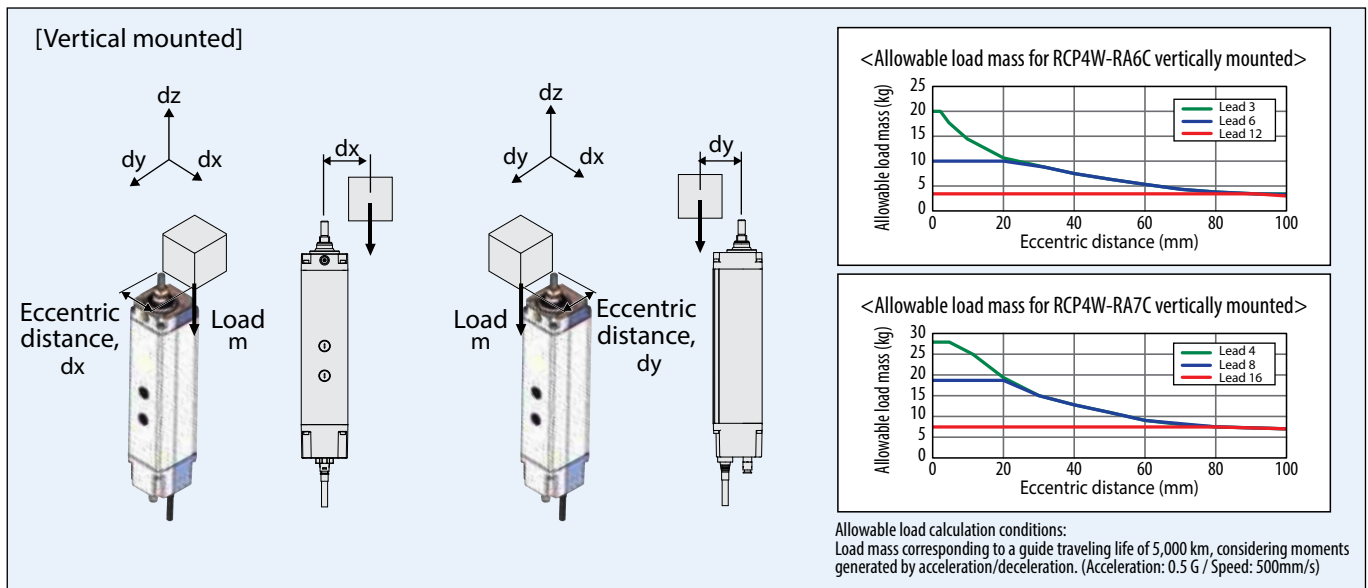

# PCON-CA/CFA

**Positioner / Pulse-train Type  
RCP4W Controller**

Refer to the catalog of the RCP4 series for the details of each controller.



## List of Models

### ROBO Cylinder Position Controller <PCON-CA/CFA>

External view										
I/O type		Positioner type	Pulse-train type	Field network type						
				DeviceNet connection specification	CC-Link connection specification	PROFIBUS-DP connection specification	CompoNet connection specification	MECHATROLINK connection specification	EtherCAT connection specification	EtherNet/IP connection specification
I/O type model code		NP/PN	PLN/PLP	DV	CC	PR	CN	ML	EC	EP
Standard price	PCON-CA	Incremental specification		—	—	—	—	—	—	—
		Simple absolute specification	With absolute battery	—	—	—	—	—	—	—
			With absolute battery unit	—	—	—	—	—	—	—
	No absolute battery	—	—	—	—	—	—	—		
PCON-CFA	Incremental specification		—	—	—	—	—	—	—	

## Model Number

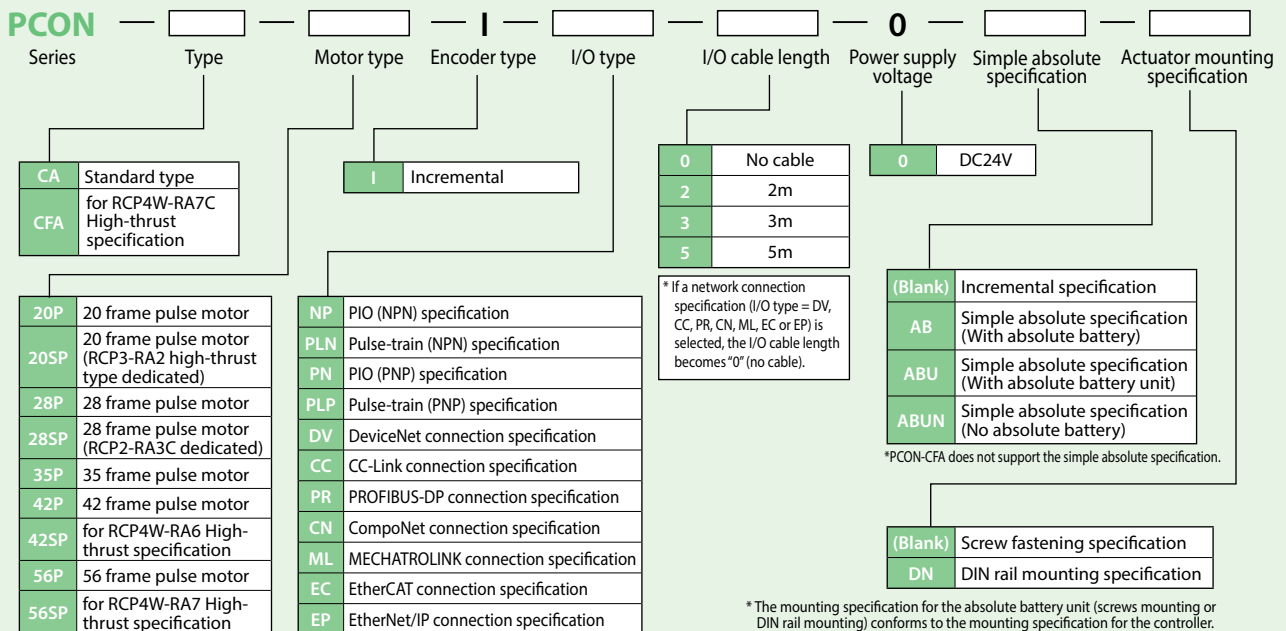



## External Dimensions

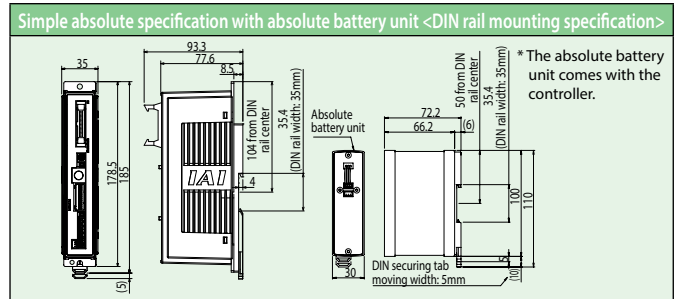
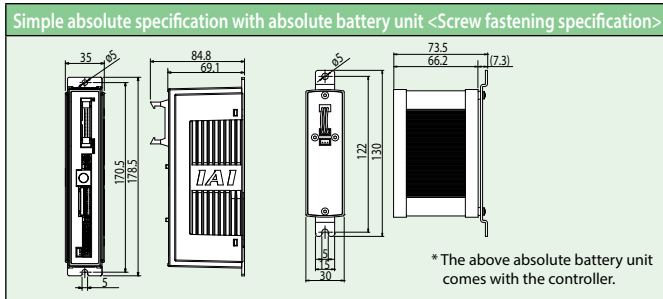
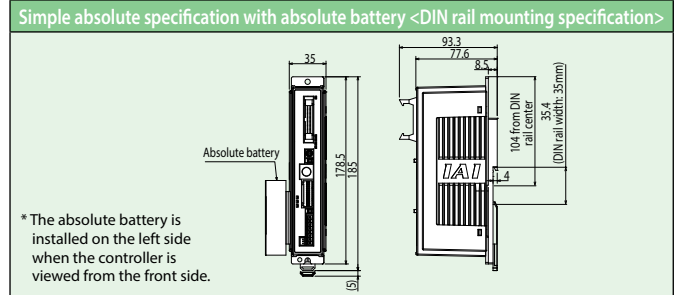
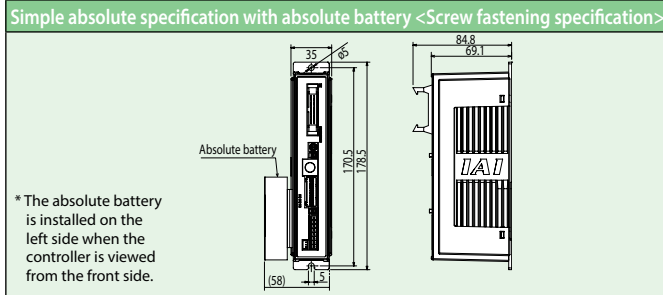
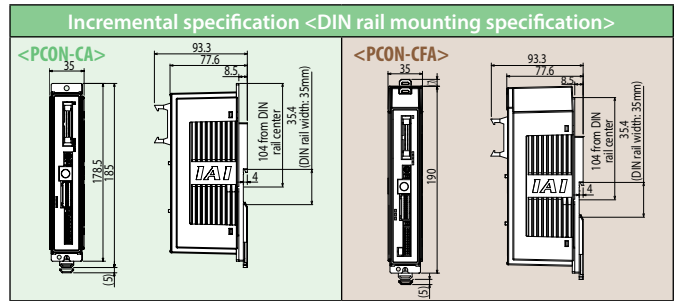
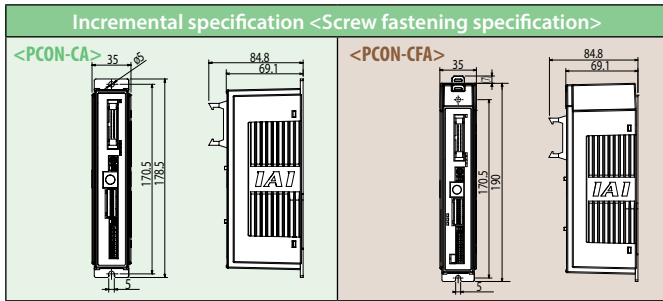

## Specification Table

Item	Description		
	PCON-CA	PCON-CFA	
Number of controlled axes	1 axis		
Power supply voltage	24 VDC ± 10%		
Load capacity <small>(Current consumption of controlled axes included, 100%.)</small>	RCP4W Motor type 42P, 42SP, 56P 56SP	2.2A max.  6A max.	
Power supply for electromagnetic brake (for actuators with brake)	24 VDC ± 10%, 0.15 A (max.)		
Rush current (Note 2)	8.3 A		
Momentary power failure resistance	500 μs max.		
Applicable encoder	Incremental encoder of 800 pulses/rev in resolution		
Actuator cable length	20m max.		
External interface	PIO specification	Dedicated 24-VDC signal input/output (NPN or PNP selected) --- Up to 16 input points, up to 16 output points / Cable length: 10m max.	
	Field network specification	DeviceNet, CC-Link, PROFIBUS, CompoNet, MECHATROLINK, EtherCAT, EtherNet/IP	
Data setting/input method	PC software, touch-panel teaching pendant		
Data retention memory	Position data and parameters are saved in the non-volatile memory (The memory can be written an unlimited number of times.)		
Operation modes	Positioner mode / Pulse-train control mode (Selectable by parameter setting)		
Number of positions in positioner mode	Up to 512 points for the positioner type, up to 768 points for the network type (Note) The number of positioning points varies depending on the PIO pattern selected.		
Pulse-train interface	Input pulse	Differential method (line driver method): 200 kpps max. / Cable length: 10 m max. Open collector method: Not supported * If the host uses open-collector output, convert the open-collector pulses to differential pulses using the AK-04 (available as an option).	
	Command pulse magnification (electronic gear ratio: A/B)	1/50 < A/B < 50/1 Setting range of A and B (set by parameters): 1 to 4096	
	Feedback pulse output	None	
Isolation resistance	500-VDC 10 MΩ or more		
Electric shock protection mechanism	Class I basic isolation		
Mass (Note 3)	Incremental specification	Screw fastening type: 250 g or less DIN rail securing type: 285 g or less	
	Simple absolute specification (190 g of battery weight included)	Screw fastening type: 450 g or less DIN rail securing type: 485 g or less	
Cooling method	Natural air cooling	Forced air cooling	
Environment	Ambient operating temperature	0 to 40°C	
	Ambient operating humidity	85%RH or less (non-condensing)	
	Operating ambience	Not exposed to corrosive gases	
	Protection degree	IP20	

Note 1) The value increases by 0.3 A for the field network specification.

Note 2) After the power is turned on, rush current will flow for approx. 5 msec (at 40°C). Take note that the rush current varies depending on the impedance of the power-supply line.

Note 3) The value increases by 30 g for the field network specification.

## Option

### Teaching pendant

■ **Summary** Teaching device for positioning input, test operation, and monitoring.

■ **Model** **CON-PTA-C** (Touch panel teaching pendant)

■ **Setting**

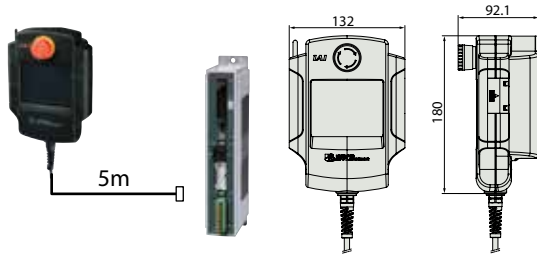

### ■ Specification

Item	Touch panel teaching		
	CON-PTA-C	CON-PDA-C	CON-PGAS-C-S
Model number	CON-PTA-C	CON-PDA-C	CON-PGAS-C-S
Type	Standard type	Enable switch type	Safety-category compliant type
Display	65536 colors (16-bit colors), white LED backlight		
Operating ambient temperature/humidity	Temperature 0 to 40°C, humidity 85%RH or less (non-condensing)		
Protection degree	IP40		
Mass	Approx. 570g	Approx. 600g	
Cable length	5m		
Accessories	Stylus	Stylus	Stylus, TP adapter (Model number: RCB-LB-TG5) Dummy plug (Model number: DP-4S) Controller cable (Model number: CB-CON-LB005)

### PC software (Windows only)

\* For the MSEP field network specification, the PC software is required.

■ **Summary** A startup support software for inputting positions, performing test runs, and monitoring. With enhancements for adjustment functions, the startup time is shortened.

■ **Model** **RCM-101-MW** (External device communication cable + RS232 conversion unit)

■ **Setting**

MSEP is supported by Ver.9.01.00.00 or later

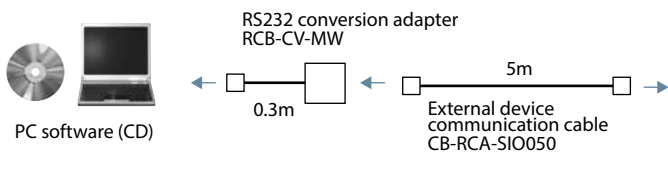

■ **Model** **RCM-101-USB** (External device communication cable + USB converter adapter + USB cable)

■ **Setting**

MSEP is supported by Ver.9.01.00.00 or later

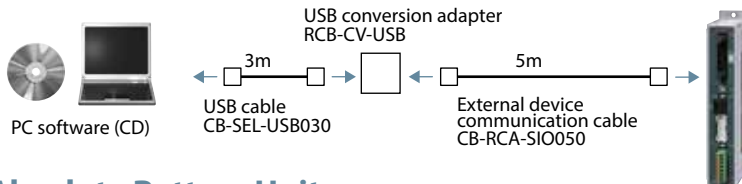

### Absolute Battery Unit

■ **Summary** Battery unit that comes with a simple absolute controller, used to back up the current controller position.

■ **Model** **SEP-ABU** (DIN rail mount specification)

**SEP-ABUS** (screw fixing specification)

■ **Specifications**

Item	Specification
Ambient operating temperature, humidity	0 to 40°C (desirably around 20°C), 95% RH or below (non-condensing)
Operating ambience	Free from corrosive gases
Absolute battery	Model number: AB-7 (Ni-MH battery / Life: Approx. 3 years)
Controller/absolute battery unit link cable	Model number: CB-APSEP-AB005 (Length: 0.5m)
Mass	Standard type: Approx. 230g / Dust-proof type: Approx. 260g

### Replacement battery

■ **Summary** The replacement battery for the absolute data backup battery box.

■ **Model** **AB-7**



DIN rail mount specification

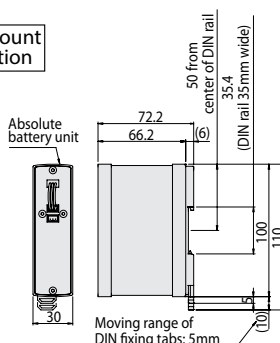

Screw fixing specification

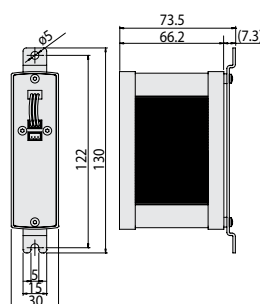

---

**IAI America, Inc.**

**Headquarters:** 2690 W. 237th Street, Torrance, CA 90505 (800) 736-1712

**Chicago Office:** 1261 Hamilton Parkway, Itasca, IL 60143 (800) 944-0333

**Atlanta Office:** 1220 Kennestone Circle, Suite 108, Marietta, GA 30066 (888) 354-9470

**[www.intelligentactuator.com](http://www.intelligentactuator.com)**

The information contained in this product brochure may change without prior notice due to product improvements.

**IAI Industrieroboter GmbH**

Ober der Röth 4, D-65824 Schwalbach am Taunus, Germany

**IAI Robot (Thailand), CO., Ltd.**

825 PhairojKijja Tower 12th Floor, Bangna-Trad RD.,

Bangna, Bangna, Bangkok 10260, Thailand

