

METRON MEASUREMENT LIGHT CURTAIN

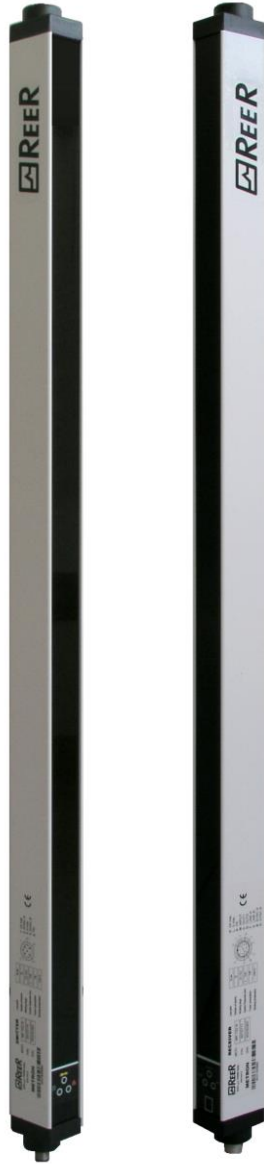

**INSTALLAZIONE, USO E MANUTENZIONE
INSTALLATION, USE AND MAINTENANCE
INSTALLATION, UTILISATION ET MAINTENANCE
INSTALLATION, BEDIENUNG UND WARTUNG
INSTALACIÓN, USO Y MANTENIMIENTO**

REER
www.reer.it

METRON MEASUREMENT LIGHT CURTAIN

CONTENTS

| | |
|--|----|
| INTRODUCTION..... | 2 |
| MODELS..... | 2 |
| Beam Positioning..... | 3 |
| HOW TO INSTALL METRON..... | 3 |
| Mechanical Assembly and Optical Alignment..... | 3 |
| Multiple Systems..... | 4 |
| Distance from Reflective Surfaces..... | 5 |
| ELECTRIC CONNECTIONS..... | 6 |
| Warnings..... | 6 |
| Emitter Connections - A and B models..... | 6 |
| Emitter Connections - C models..... | 7 |
| Receiver Connections - A and B models..... | 7 |
| M16 12-pole Main Connector..... | 7 |
| M8 3-pole Programming Connector (RS-232) - A and B models..... | 8 |
| Female Connector DB9 for Connecting to PC Serial Port (RS-232)..... | 8 |
| METRON - PC Connection Cable..... | 9 |
| Receiver Connections - C models..... | 9 |
| Signals..... | 10 |
| DIMENSIONS..... | 12 |
| LIGHT CURTAIN TECHNICAL FEATURES..... | 13 |
| PROGRAMMING AND OPERATION OF STATIC OUTPUTS..... | 14 |
| OPERATION THROUGH SERIAL LINE RS-485..... | 14 |
| Using the <i>REER METRONCONF</i> Configuration Program..... | 14 |
| Preliminary Operations..... | 15 |
| METRON Configuration..... | 16 |
| Light Curtain Connection..... | 17 |
| Metron A (4 OUT) Configuration..... | 18 |
| METRON B (2 OUT) Configuration with Standard Serial Line RS-485..... | 21 |
| MODEL B (2 OUT) FACTORY SETTINGS..... | 24 |
| METRON B (2 OUT) configuration in RS-485 on network mode..... | 25 |
| Configuration saving/opening..... | 26 |
| Send Configuration to Light Curtain..... | 26 |
| Light Curtain Configuration Reading..... | 27 |
| Light Curtain Disconnection..... | 27 |
| SENT DATA PACKET CONFIGURATION ON RS-485..... | 27 |
| Light Curtain Status Monitoring..... | 28 |
| WARRANTY..... | 30 |

 METRON light curtains **MUST NOT** be used as safety devices for protection of operators in dangerous areas.

INTRODUCTION

The METRON light curtain is a multibeam optoelectronic system, composed of an Emitter unit and a Receiver unit, used for the detection or measurement of objects of dimensions up to 2500mm. Synchronisation between the two units can take place via optical link or via cable (with optical link only in METRON C models).

The barrier output conditions (resident in the receiver) vary as soon as a measurement is made (or an object is detected).

MODELS

Metron is available in 3 different model families (A, B and C) with variable heights and resolutions:

- *MODELS A*: Models for the measurement of objects, with controlled field from 150mm to 2500mm and resolution equal to 5/10/25/30/50/75mm, which have 4 static outputs. These are activated when one or more conditions requested by the user are detected.
- *MODELS B*: Models for the measurement of objects, with controlled field from 150mm to 2500mm and resolution equal to 5/10/25/30/50/75mm, which have a RS-485 communication line and 2 static outputs. These are activated when one or more conditions requested by the user are detected.
- *MODELS C*: Models for the measurement of objects, with controlled field from 150mm to 2500mm and resolution equal to 5/10/25/30/50/75mm, which have 2 antivalent static outputs which change status on the interruption / release of the controlled field.

Beam Positioning

The following figure shows the arrangement of beams and their numbering:

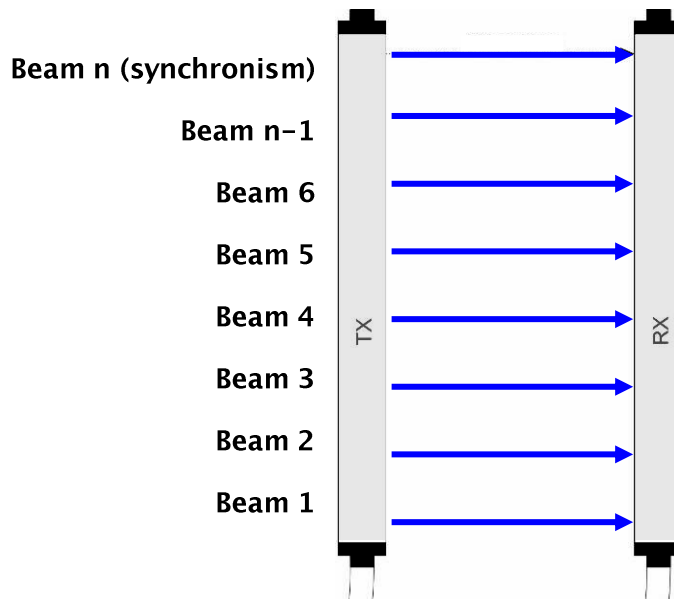

Figure 1

- ➔ It is important to note that the beam numbering starts from the bottom, as shown in the figure. If synchronism is by cable, even the last beam can also be used for measurement.
- ➔ When the optical synchronism is used, the last beam towards the top must never be used to avoid interruption of the measuring function.

HOW TO INSTALL METRON

Mechanical Assembly and Optical Alignment

The Emitter and the Receiver must be assembled in front of each other at a distance equal to or lower than that indicated in the technical data; using the supplied inserts and fastening brackets, place the Emitter and the Receiver in such a way that they are aligned and parallel, with the connectors facing the same side.

According to the size and shape of the support on which the Emitter and the Receiver are to be mounted, the fixtures can be positioned on the back, or they can be inserted into the side groove (Figure 2).

Perfect alignment between the Emitter and the Receiver is essential to ensure correct operation of the light curtain; This procedure is facilitated by observing the Emitter and the Receiver signal LEDs.

To make alignment between the Emitter and the Receiver easier, the SFB circular brackets can be used, which are available by order (code 1330974).

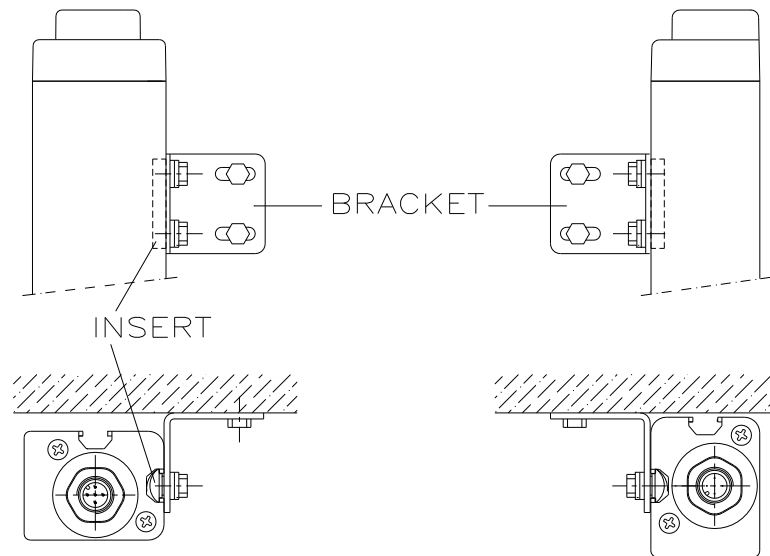

Figure 2

- Align the first and last beams of the Emitter with the corresponding beams on the receiver.
- Move the Emitter to find the area in which the green LED on the Receiver remains on.
- Secure the Emitter and the Receiver in position.
- If you are using the optical synchronism (first beam on the top, Figure 1), a flashing "o" on the Receiver's display means that the synchronism beam is not aligned.

Multiple Systems

When a number of METRON systems are used, optical interference between them and with other optical sensors should be avoided: position the elements in such a way that the beam emitted by the Emitter of a system is only received by its corresponding Receiver.

Figure 3 shows some examples of the correct positioning between the two light curtain systems. Incorrect positioning could generate interference, leading to possible malfunctioning.

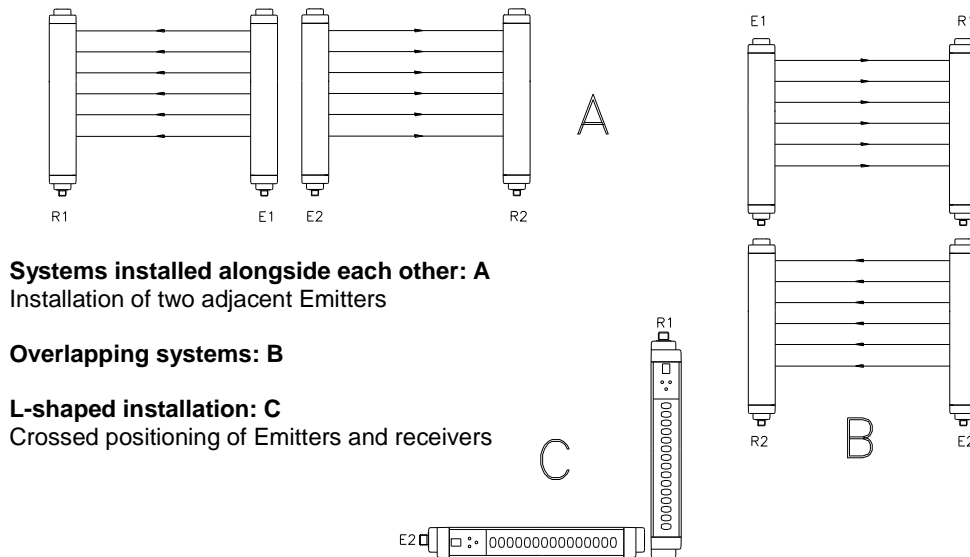

Figure 3

Distance from Reflective Surfaces

The presence of reflective surfaces near the light curtain may cause spurious reflections which prevent detection. In Figure 4, object A is not detected due to surface S, which by reflecting the beam closes the optical path between the Emitter and the Receiver. Therefore, a certain distance (refer to the following warnings) should be maintained between any reflective surfaces and the sensitive area.

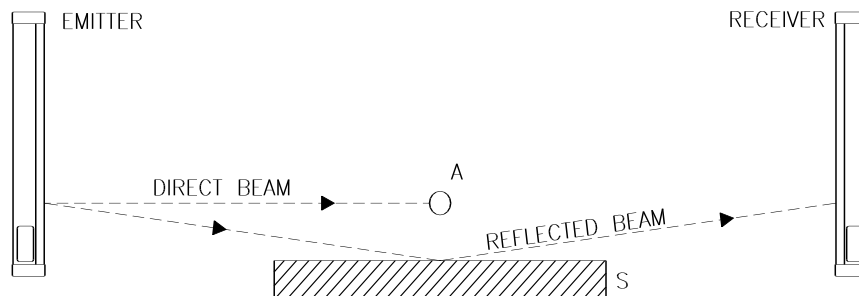

Figure 4

Once installed, verify the presence of any reflective surfaces that may be intercepting the beams, first in the middle and then in the proximity of the Emitter and the Receiver. During this procedure the red LED on the Receiver must not turn off under any circumstance.

- ➔ To reduce the reflection phenomenon (in models 5-25-50-75mm) it could be useful to set the **"reduced sensitivity"** with the METRONCONF Programme (see Page 20).
- ➔ In any case, a reflective surface must never be present at a distance under 30cm.

ELECTRIC CONNECTIONS

Warnings

Before carrying out the electrical connections, please ensure that the available power supply is in compliance with that indicated in the technical data.

➔ Emitter and Receiver must have a power supply of 24Vdc±20%.

– In order to guarantee reliability of operation, using a diode bridge on the power supply, output capacity must be at least 2000µF for each A of absorption.

Emitter Connections - A and B models

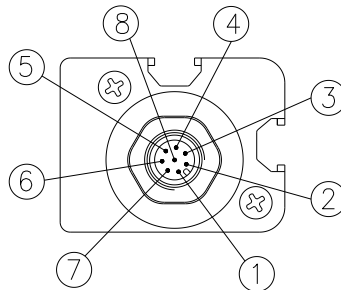

Figure 5

| PIN | NAME | DESCRIPTION |
|-----|------------|--|
| 1 | SYNC A | TX-RX Synchronism |
| 2 | 24 VDC | Power supply (positive) |
| 3 | SYNC B | TX-RX Synchronism |
| 4 | SEL RANGE | Range selection |
| | | 0VDC -> Low range 24VDC -> High range |
| 5 | SEL ORIENT | Orientation selection |
| | | 0VDC -> Normal orientation 24VDC -> Upside-down orientation |
| 6 | N.C. | - |
| 7 | 0 VDC | Power supply (negative) |
| 8 | PE | Earth connection |

Table 1

- ➔ If synchronisation by cable is to be used, pins 1 and 3 must be connected to the respective signals (pin B and D) on the receiver column. In this case, synchronisation is ensured even in the absence of all beams (completely obstructed light curtain).
- ➔ Also check that pin 7 (0Vdc) is connected to pin L of the receiver.
- ➔ If synchronisation via cable is not necessary, leaving pins 1 and 3 free will activate optical synchronisation and the synchronism beam will be the first on top (the most distant from the connector).
- ➔ In both cases, if the synchronism function is lost (faulty connection or interrupted synchronism beam) the METRON measurement function will be lost, outputs will be reset to zero and the transmission of data packages will be interrupted (model with RS-485).

Emitter Connections - C models

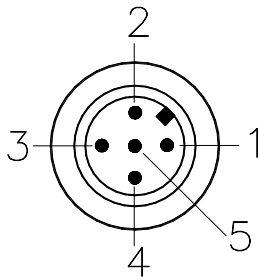

Figure 6

| PIN | NAME | DESCRIPTION |
|-----|-----------|-------------------------|
| 1 | 24 VDC | Power supply (positive) |
| 2 | RANGE SEL | 0VDC -> Low range |
| | | 24VDC -> High range |
| 3 | 0 VDC | Power supply (negative) |
| 4 | N.C. | - |
| 5 | PE | Ground connection |

Table 2

Receiver Connections - A and B models

The receiver is equipped with an M16, 12-pole main connector and, on configurable models (see section "CONFIGURATION (SERIAL LINE RS-232) AND FUNCTIONALITY USING SERIAL LINE RS-485", of an M8, 3-pole configuration connector (RS-232).

M16 12-pole Main Connector

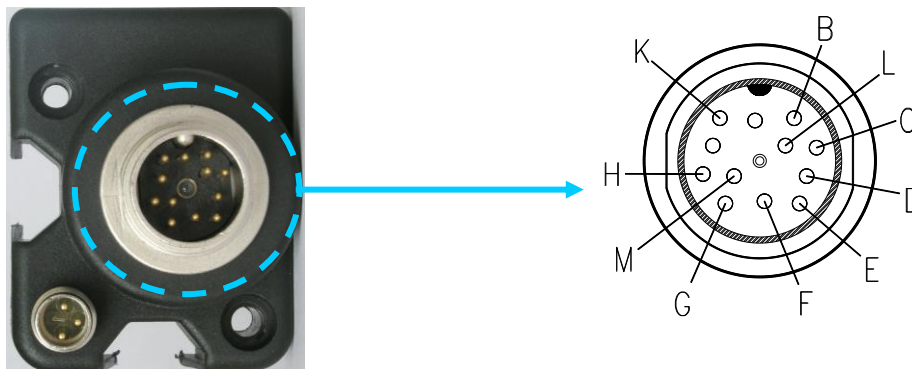

Figure 7

Regarding the Receiver, several models will be available:

- A) Model with 4 solidstate outputs and one input (with configurable functionality through a serial line).

| PIN | NAME | DESCRIPTION |
|-----|--------|--|
| H | 24 Vdc | Power supply (positive) |
| L | 0 Vdc | Power supply (negative) |
| K | PE | Ground connection |
| C | OUT1 | Static output 1 : 100mA @ 24VDC |
| M | INPUT | Digital input with programmable function |
| G | OUT2 | Static output 2 : 100mA @ 24VDC |
| B | SYNC A | TX-RX Synchronism |
| D | SYNC B | TX-RX Synchronism |
| F | OUT3 | Static output 3 : 100mA @ 24VDC |
| E | OUT4 | Static output 4 : 100mA @ 24VDC |

Table 3

B) Model with one input, two solid state outputs (with configurable functionality through a serial line) synchronisation by cable and RS-485 serial communication line (for data analysis).

| PIN | NAME | DESCRIPTION |
|-----|------------|--|
| H | 24 Vdc | Power supply (positive) |
| L | 0 Vdc | Power supply (negative) |
| K | PE | Ground connection |
| C | OUT1 | Static output 1 : 100mA @ 24VDC |
| M | INPUT | Digital input with programmable function |
| G | OUT2 | Static output 2 : 100mA @ 24VDC |
| B | SYNC A | Synchronism TX-RX |
| D | SYNC B | Synchronism TX-RX |
| F | LINE + (B) | RS-485+(B) Serial line |
| E | LINE - (A) | RS-485-(A) Serial line |

Table 4

➔ If a RS-485 serial line is used, pins F,E and L must be connected to the RS-485 communication device.

M8 3-pole Programming Connector (RS-232) - A and B models



Figure 8

The male connector beside the receiver power supply main connector represented in Figure 8 allows METRON to connect with the serial port of a Personal Computer.

Female Connector DB9 for Connecting to PC Serial Port (RS-232)

The following table shows the signals which must be carried to the PC serial port using a female DB9 connector.

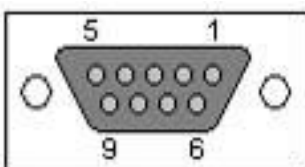

Figure 9

| PIN | NAME | DESCRIPTION |
|-----|------|-------------------|
| 2 | TX | Transmission line |
| 3 | RX | Reception line |
| 5 | GND | Ground connection |

Table 4

METRON - PC Connection Cable

REER can provide (on request) a METRON-PC CSL3 connection cable (sales code 1330994):



Figure 10

Receiver Connections - C models

C) Model with 2 solid state outputs.

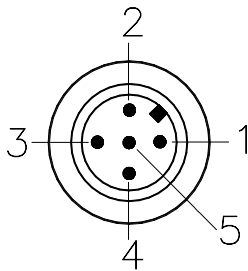

Figure 11

| PIN | NAME | DESCRIPTION |
|-----|--------|---|
| 1 | 24 VDC | Power supply (positive) |
| 2 | OUT1 | Static output 1 : 100mA @ 24VDC DARK-ON |
| 3 | 0 VDC | Power supply (negative) |
| 4 | OUT2 | Static output 2 : 100mA @ 24VDC LIGHT-ON |
| 5 | PE | Ground connection |

Table 5

Signals

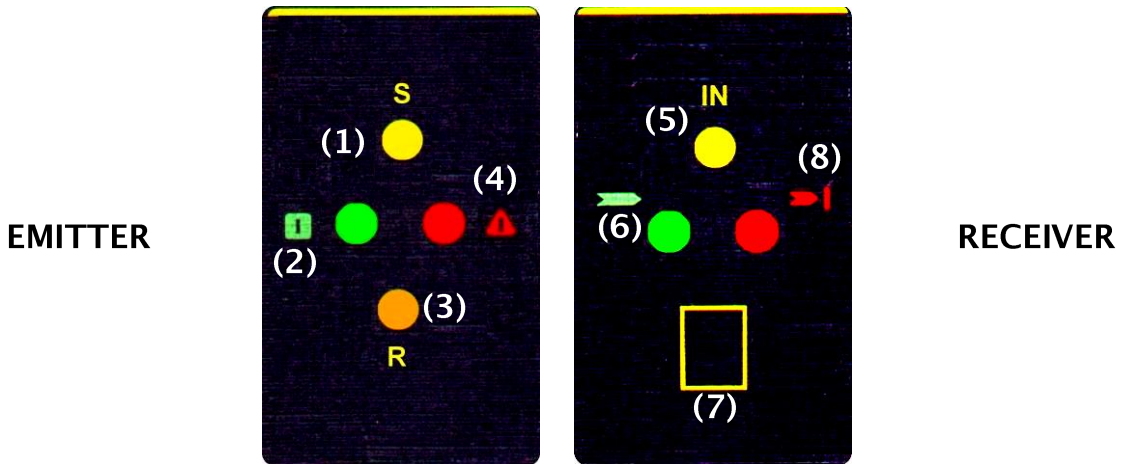

Figure 12

EMITTER – A and B models

| LED 1 YELLOW | LED 2 GREEN | LED 3 ORANGE | LED 4 RED | INDICATION |
|--------------------|----------------|--------------------|--------------|---|
| ON | Off | ON | ON | System start. |
| ON | ON | Off | Off | Operation with optical synchronism low range * |
| ON | ON | ON | Off | Operation with optical synchronism high range * |
| Off | ON | Off | Off | Operation with synchronism by cable low range |
| Off | ON | ON | Off | Operation with synchronism by cable high range |
| Flashes every 0,4s | off | Off | ON | Lack of synchronism by cable (if set) |
| Flashes every 0,1s | Off | Off | ON | Synchronism mode change |
| Off | Off | Flashes every 0,1s | ON | Range input error |
| Flashes every 0,1s | Off | Flashes every 0,1s | ON | Internal failure |

Table 6

* In the case of upside-down orientation, LED 1 will flash 3 times before normal operation.

EMITTER – C models

| LED 1 YELLOW | LED 2 GREEN | LED 3 ORANGE | LED 4 RED | INDICATION |
|------------------|----------------|------------------|--------------|----------------------|
| ON | off | ON | ON | System start. |
| ON | ON | off | off | Operation low range |
| ON | ON | ON | off | Operation high range |
| off | off | Lamp. every 0,1s | ON | Range input error |
| Lamp. every 0,1s | off | Lamp. every 0,1s | ON | Internal failure |

Table 7

RECEIVER – A and B models

| LED 5 YELLOW | LED 6 GREEN | LED 8 RED | 7 DISPLAY | INDICATION |
|-----------------|----------------|--------------|------------------|--|
| ON | off | ON | 8 | System start. |
| - | ON | off | o | Operation with optical synchronism, controlled field clear |
| - | off | ON | o | Operation with optical synchronism, controlled field in use |
| - | off | ON | o (flashing) | Operation with optical synchronism, synchronism beam in use |
| - | ON | off | c | Operation with synchronism by cable, controlled field clear |
| - | off | ON | c | Operation with synchronism by cable, controlled field in use |
| - | off | ON | c (flashing) | Operation with synchronism by cable, lack of synchronism by cable |
| off | - | - | - | Lack of INPUT |
| ON | - | - | - | Active INPUT |
| off | off | ON | P | Connected configurator |
| off | off | ON | P (flashing) | End configurator connection |
| off | off | ON | A (flashing+ F) | Optical card failure |
| off | off | ON | E (flashing + F) | Microcontroller card failure |
| off | off | ON | C (flashing+ F) | Configuration error |

Table 8

RECEIVER – C models

| LED 5 YELLOW | LED 6 GREEN | LED 8 RED | 7 DISPLAY | INDICATION |
|-----------------|----------------|--------------|-----------------|------------------------------|
| ON | off | ON | 8 | System start |
| - | ON | off | o | Controlled field clear |
| - | off | ON | o | Controlled field in use |
| - | off | ON | o (lamp.) | Synchronism beam in use |
| off | off | ON | A (lamp.+ F) | Optical card failure |
| off | off | ON | E (lamp.+ F) | Microcontroller card failure |

Table 9

DIMENSIONS

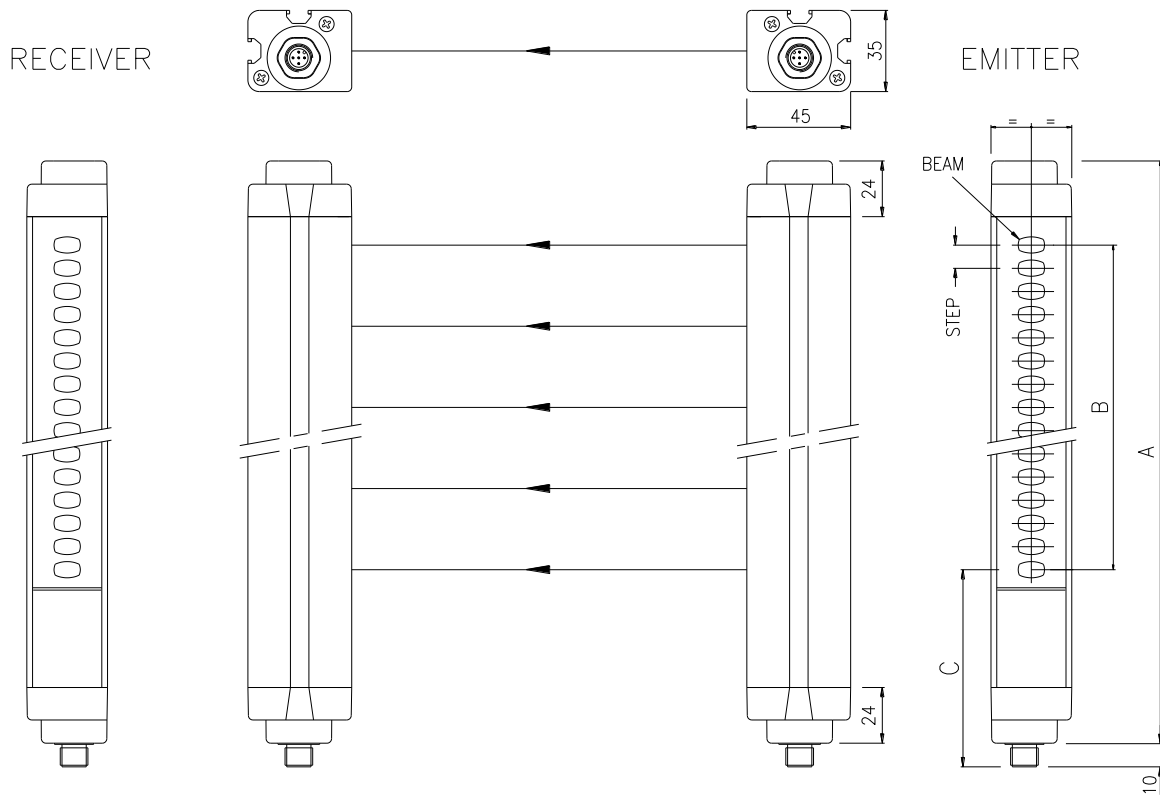

| ME Model | 150 | 300 | 450 | 600 | 750 | 900 | 1050 | 1200 |
|------------------------|--|-----|-----|-----|-----|------|------|------|
| A | 251 | 401 | 551 | 701 | 851 | 1001 | 1151 | 1301 |
| B (Measurement Height) | $B = (\text{beams number} - 1) \times \text{step}$ (with cable synchronism) $B = (\text{beams number} - 2) \times \text{step}$ (with optical synchronism) * | | | | | | | |
| C (1st beam Height) | 85 (for 5, 10 and 30 models) - 93 (for 25, 50 and 75 models) | | | | | | | |
| Mounting | 2 LS brackets with 2 mounting inserts | | | | | | | |

| ME Model | 1350 | 1500 | 1650 | 1800 | 1950 | 2100 | 2250 | 2400 | 2550 |
|------------------------|--|------|------|------|------|------|------|------|------|
| A | 1451 | 1601 | 1751 | 1901 | 2051 | 2201 | 2351 | 2501 | 2651 |
| B (Measurement Height) | $B = (\text{beams number} - 1) \times \text{step}$ (with cable synchronism) $B = (\text{beams number} - 2) \times \text{step}$ (with optical synchronism) * | | | | | | | | |
| C (1st beam Height) | 85 (for 5, 10 and 30 models) - 93 (for 25, 50 and 75 models) | | | | | | | | |
| Mounting | 3 LS brackets with 3 mounting inserts | | | | | | | | |

* In the case of optical synchronism, the beam beside the upper cover cap cannot be used for the measurement as it is the synchronism beam.

LIGHT CURTAIN TECHNICAL FEATURES

| METRON LIGHT CURTAIN TECHNICAL FEATURES – A and B models | | | |
|--|-----|---|-----------------|
| Measurement Height | mm | 150 - 2500 | |
| Space between beams | mm | 5 - 10 - 25 - 30 - 50 - 75 | |
| Working range | m | 5mm | 0,2÷1 / 0,8÷2 |
| | | 10 - 30mm | 0÷6 / 1÷16 |
| | | 25 - 50 - 75mm | 0,2÷2,5 / 1,5÷6 |
| Power supply | VDC | 24 ± 20% | |
| Connections | | M12 - 8-pole Emitter M16 - 12-pole Receiver (M8 for RS-232 serial configuration) | |
| Measurement time | | (2.25 ms + 70 µs x nbeams) x 2 | |
| Synchronisation Mode | | Optical or by cable, selectable | |
| Length max. connect. | m | 50 | |
| Operating temp. | °C | 0 ÷ 55°C | |
| Degree of Protection | | IP 65 | |
| Section dimensions | mm | 35 x 45 | |
| Max. power consumption | W | 2 (Emitter) 2 (Receiver) | |
| Output | | Up to 4 static outputs of 100mA @ 24VDC (configurable function) | |
| Communication lines | | RS-485 (up to 8 nodes) for measuring data RS-232 for programming | |
| Inputs | | Inputs for Enable/Disable/Strobe (0-24Vdc active high) | |
| Minimum duration of the input signal | ms | 5 | |

| METRON LIGHT CURTAIN TECHNICAL FEATURES – C models | | | |
|--|-----|---|-----------------|
| Measurement Height | mm | 150 - 2500 | |
| Space between beams | mm | 5 - 10 - 25 - 30 - 50 - 75 | |
| Working range | m | 5mm | 0,2÷1 / 0,8÷2 |
| | | 10 - 30mm | 0÷6 / 1÷16 |
| | | 25 - 50 - 75mm | 0,2÷2,5 / 1,5÷6 |
| Power supply | VDC | 24 ± 20% | |
| Connections | | M12 - 5 poles | |
| Measurement time | | (2.25 ms + 70 µs x nbeams) x 2 | |
| Length max. connect. | m | 50 | |
| Operating temp. | °C | 0 ÷ 55°C | |
| Degree of Protection | | IP 65 | |
| Section dimensions | mm | 35 x 45 | |
| Max. power consumption | W | 2 (Emitter) 2 (Receiver) | |
| Output | | 2 static outputs of 100mA @ 24VDC 1 DARK-ON + 1 LIGHT-ON | |

PROGRAMMING AND OPERATION OF STATIC OUTPUTS

The function programming system, allows the operation associated with each output to be selected (see section "*Using the REER METRONCONF configuration program*").

These functions can be divided into basic functions and advanced functions. The basic functions allow one of the outputs to be activated in the event that a preset condition occurs, which may be dependent on another condition (using the conventional logical operators AND/OR).

Example: Activate output No. 1 if the obstructed beam is number 12; activate output No. 2 if the last obstructed beam is number 15 AND the total number of obstructed beams is more than 6.

OPERATION THROUGH SERIAL LINE RS-485

Using the *REER METRONCONF* Configuration Program

METRON is equipped with a 3-pin connector on the receiver (see section about connections) for connection to a personal computer using a serial line RS-232.

METRON configuration can be achieved using the function programming system (*REER METRONCONF*) for the following:

- Configuration of serial line RS-485 (baud rate, parity, start and stop characters and format: binary, hex, ascii, etc.).
- Setting of conditions (also in combination with the operators AND / OR) which allow activation of the outputs. The following conditions can be selected:

- **FBO** First obstructed beam
- **LBO** Last obstructed beam
- **CBO** Central obstructed beam *
- **NBO** Number of occupied beams
- **NCBO** Maximum number of consecutively obstructed beams *
- **BNO** beam **n** obstructed

* If several zones are obstructed , the data refers to the zone with the highest number of obstructed beams.

A graphic interface can also be displayed for real-time monitoring of light curtain conditions.

The following figures illustrate some screens from the *REER METRONCONF* program, through which the user can configure *METRON*'S operating logic.

Preliminary Operations

Insert the METRONCONF CD-ROM in the computer and follow the instructions for software installation. To launch METRONCONF double click on the icon created on the desktop.



Figure 13 – Opening Screen

The various buttons on the initial screen allow the operator to go to different environments for the following specific purposes :

- ➔ METRON configuration ("SETUP PARAMETERS" button) (see page 15)
- ➔ Monitoring the light curtain status ("ON LINE MODE" button) (see page 28).
- ➔ Selecting the required serial port for connection via RS-232 ("COM SELECTION" button) (see below).
- ➔ Language selection.

Figure 14 shows the computer serial port selection screen. Use the "COM SELECTION" button to activate it.



Figure 14 - Select Serial Port

METRON Configuration

After pressing the "SETUP PARAMETERS" button, the following screen will appear:

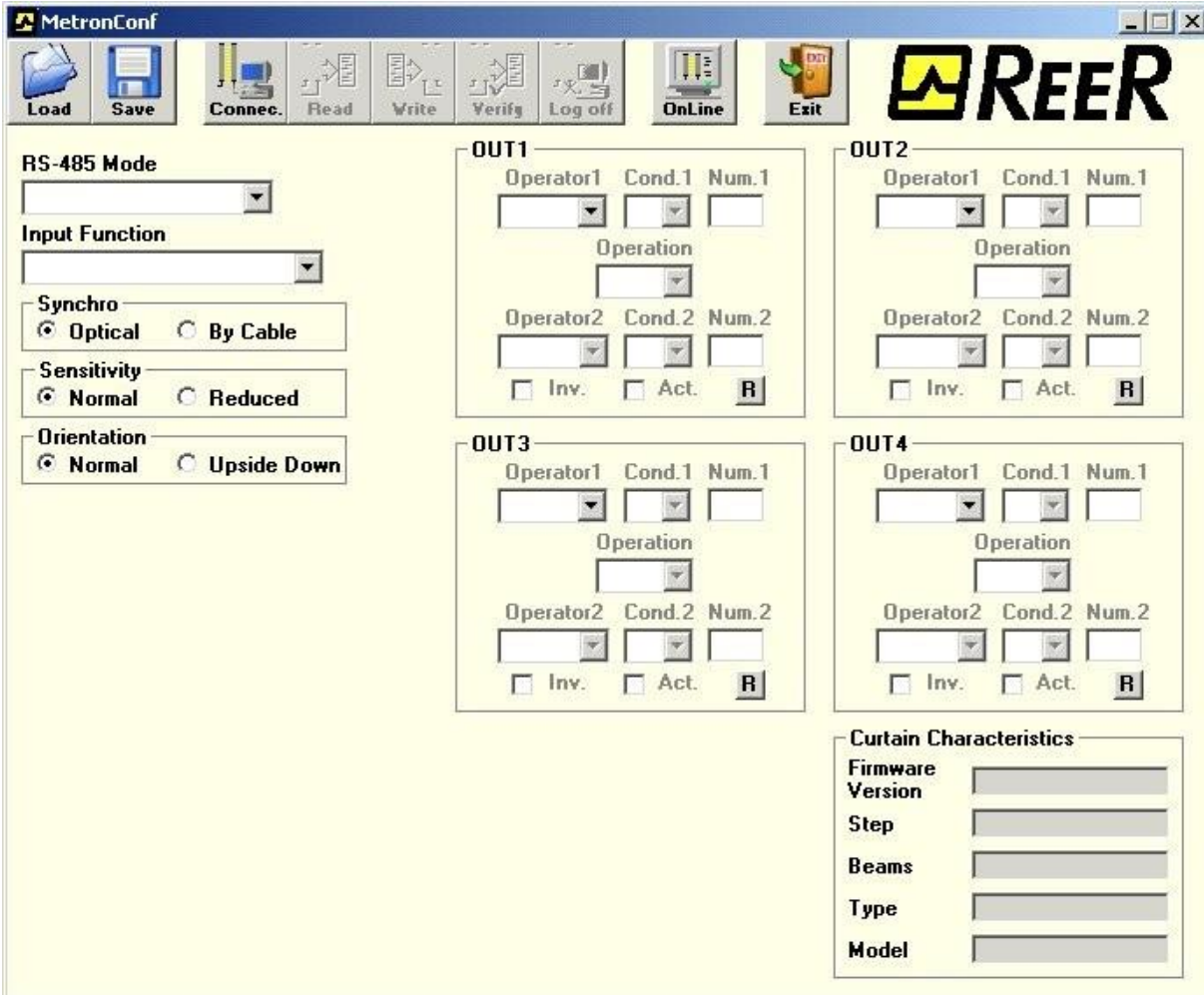

Figure 15

Even when the light curtain is not connected, the configuration fields can be filled in and the configuration can be saved on the computer using the



icon.

A previously saved configuration can be recalled subsequently by the operator .

Light Curtain Connection

Select the  icon to activate the METRON connection to the computer.

When the connection has been established, the "CURTAIN CHARACTERISTICS" (1) panel in the bottom right corner is automatically completed (Figure 16).

At this stage the light curtain's measuring function is lost as the programming mode is activated (the letter "P" will appear on the receiver's display).

At the end of the programming phase, remember to follow the "DISCONNECTION" procedure in order to reactivate the light curtain:

Select the  icon in order to disconnect the light curtain. After approximately 10seconds the light curtain will become active again using the last configuration sent to it.

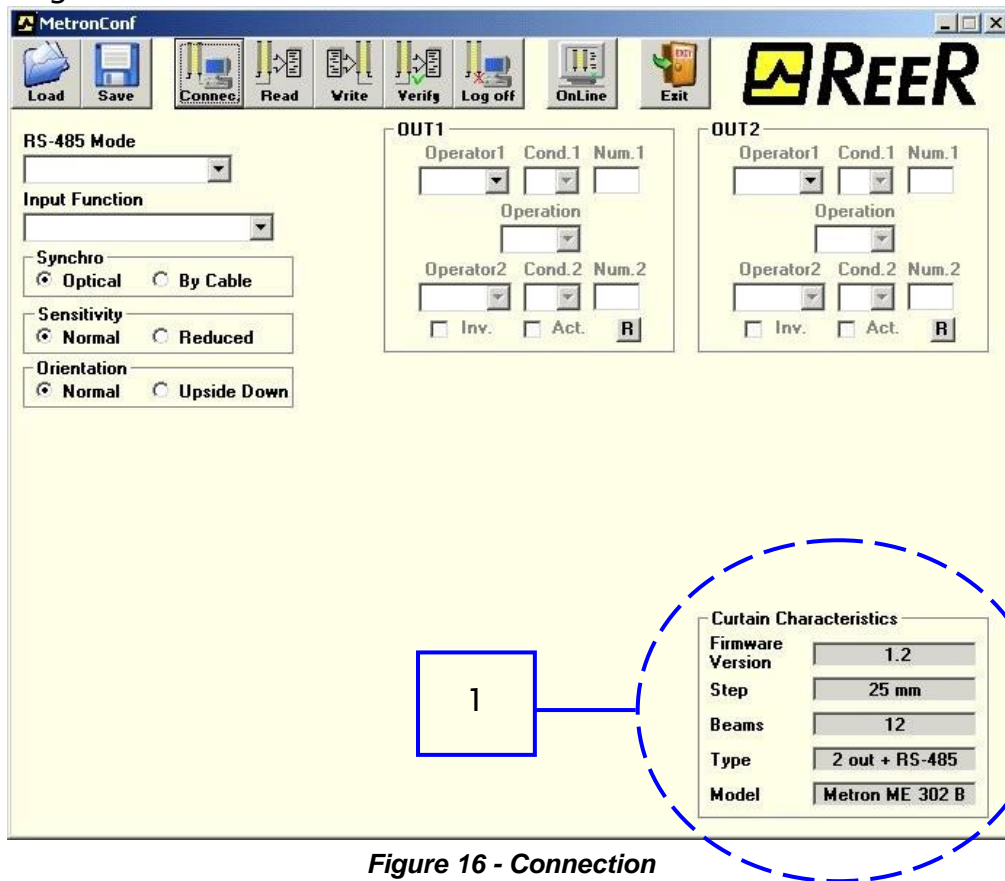

Figure 16 - Connection

Metron A (4 OUT) Configuration

Figure 17 shows the condition configuration screen (in which the operators AND / OR can also be used) through which the 4 outputs can be activated. Select the "No line" option in the "RS-485 MODE" drop-down menu .

In the example in Figure 17, the following conditions are active:

OUT1) Number of obstructed beams ≥ 1

OUT2) First obstructed beam ≥ 10 AND Last obstructed beam ≤ 20

OUT3) Beam N° 29 obstructed (OUT3 active low)

OUT4) Number of consecutively obstructed beams ≥ 5 OR Number of consecutively obstructed beams ≤ 10

Figure 17 - METRON 4 OUT Configuration

- 1** **Input function configuration:**
 The light curtain input signal (**INPUT-pin M**) (*minimum duration = 5ms, active high*) function can be programmed . The various options are as follows :

| | |
|--------------------------|--|
| NO FUNCTION | The outputs are activated when preset conditions occur |
| OUTPUT ENABLE | Enables activation of the outputs when the conditions set occur |
| OUTPUT STAND-BY | Freezes the last output condition |
| OUTPUT START/STOP | Establishes start and end of a measurement session. The outputs are activated in the t_1 instant (Figure 18) only if the preset conditions are met in this timeframe (example. $NB0 \geq 1$) |

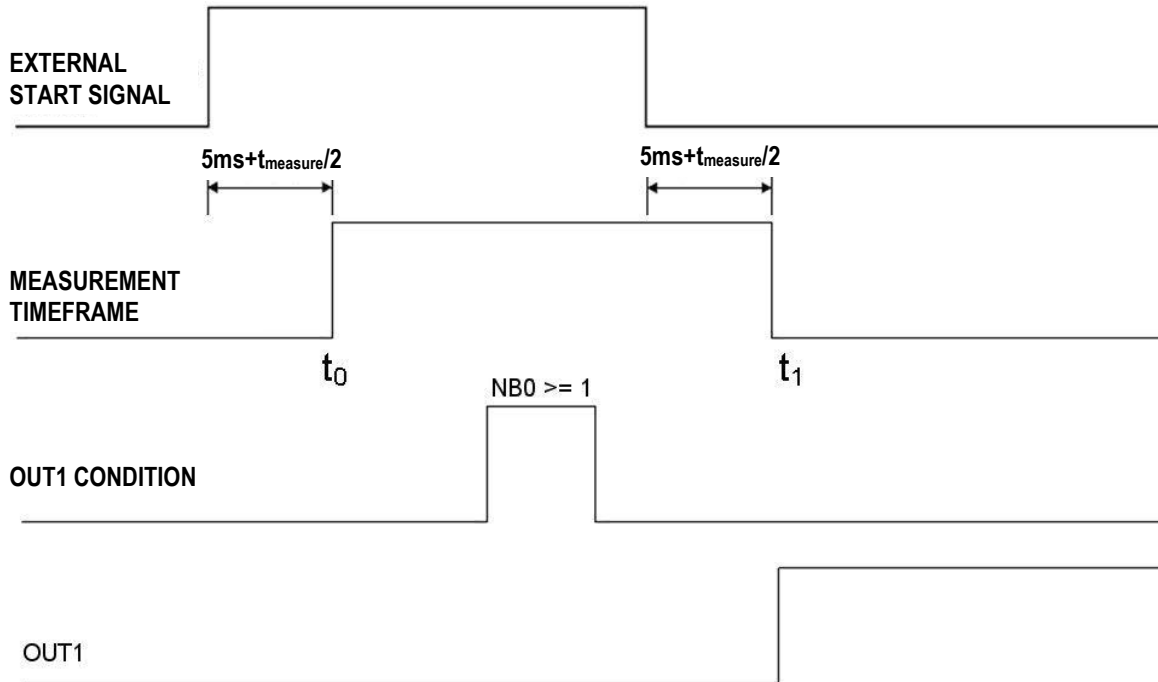

Figure 18 – OUTPUT START/STOP

- 2** **Synchronism Configuration:**
 The synchronisation between TX and RX can be programmed in the following modes :

| | |
|-------------------------|--|
| SYNCHRO BY CABLE | Synchronisation is carried out by connecting the two emitter and receiver signal pairs SYNC A and SYNC B . |
| SYNCHRO OPTICAL | Synchronisation is achieved by using the last beam of the light curtain. |

- ➔ When optical synchronism is used, the last beam towards the top must not be obstructed otherwise the measurement function will be interrupted.
- ➔ To switch from cable to optical synchronism, the emitter must be turned off and restarted.

3 Sensitivity Configuration:

It is possible to modify the receiver’s sensitivity depending on the distance from the Emitter.

| | |
|----------------------------|-----------------------------------|
| NORMAL SENSITIVITY | Recommended for $d > 50\text{cm}$ |
| REDUCED SENSITIVITY | Recommended for $d < 50\text{cm}$ |

- ➔ When reduced sensitivity is used, it is recommended to select the lower range on the emitter (see Table 1).

4 Orientation Configuration:

Beam numbering can be configured based on the light curtain’s orientation:

| | |
|--------------------------------|---|
| NORMAL ORIENTATION | Connectors down – first beam down |
| UPSIDE DOWN ORIENTATION | Connectors up – first beam down |

- ➔ When upside-down orientation is used, this should also be selected on the emitter (see Table 1).
- ➔ In case of optical synchronism, the synchronism beam will **always be the last beam up**.

5 Output Configuration:

The conditions that cause the activation of individual outputs can be programmed (see Page 12).

- Using box **INV.** , the output logic can be inverted.
- Using box **ACT.** , the output itself can be activated/deactivated.
- The **R** switch allows all the fields of each individual output to be reset.

MODEL A (4 OUT) FACTORY SETTINGS

| | |
|---------------------------|---------------------------------|
| INPUT FUNCTION | No function |
| SYNCHRONISM | Optical |
| STATIC OUTPUT | OUT1 active |
| CONDITION FOR OUT1 | $NB0 \geq 1$ (presence control) |
| ORIENTATION | Normal |
| SENSITIVITY | Normal |

METRON B (2 OUT) Configuration with Standard Serial Line RS-485

Figure 19 shows the serial RS-485 configuration screen . Select the "RS-485 Standard" option from the " MODALITYLINE RS-485" drop-down menu.

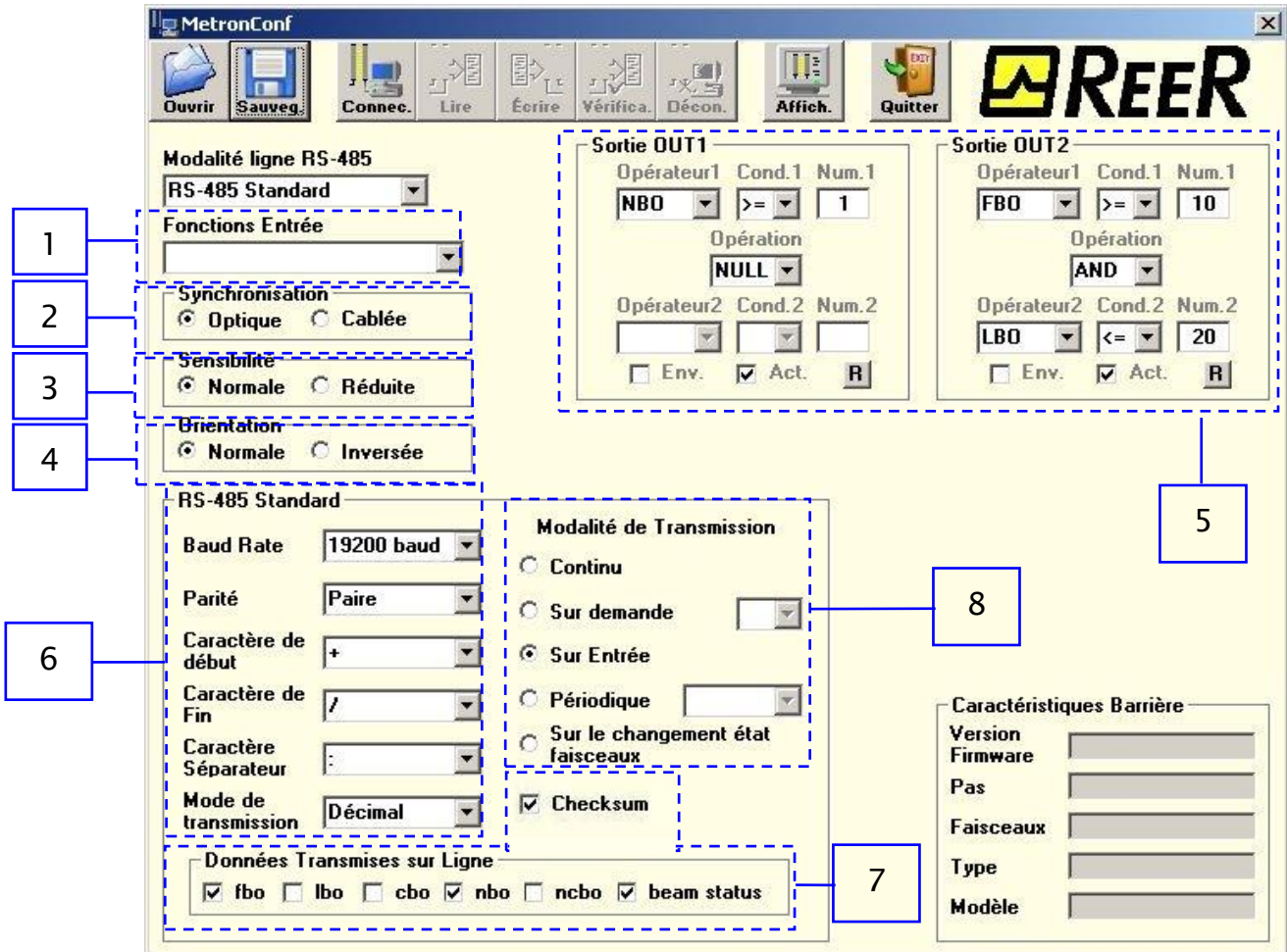

Figure 19 - RS-485 STANDARD

- 1

Input Function Configuration:
 The input Function signal (INPUT-pin M) (*minimum duration = 5ms, active high*) on the light curtain can be programmed.
 The various options are described in section "METRON A (4 OUT) CONFIGURATION".

If the transmission modality "UPON INPUT" is selected (in zone [8](#)), the following further functions will be activated:

| | |
|--------------------------------|---|
| NO FUNCTION | The outputs are activated when preset conditions occur and METRON sends a new data packet as soon as the previous one is finished |
| LINE ENABLE | Enables and disables the transmission of packets on the RS-485 line |
| LINE+OUTPUTS ENABLE | Enables and disables the required functions for the various outputs and transmission of packets on the RS-485 line |
| OUTPUTS STAND-BY | Repeats the process of sending the last data packet |
| LINE+OUTPUTS STAND-BY | Repeats the process of sending the last data packages and freezes the last situation present on the output |
| LINE START/STOP | Establishes the beginning and end of a measurement session. In the t_1 instant (Figure 20) METRON sends 3 data packets containing the maximum value detected during the measurement session (from t_0 to t_1) on the RS-485 line. The transmitted data will be that selected in zone 7 |
| LINE+OUTPUTS START/STOP | Establishes the beginning and end of a measurement session. In the t_1 instant (Figure 20) METRON sends 3 data packets containing the maximum value detected during the measurement session (from t_0 to t_1) on the RS-485 line. The data transmitted will be that selected in zone 7 . The outputs activated in the instant t_1 (Figure 18) only if the preset conditions are met in this timeframe. |

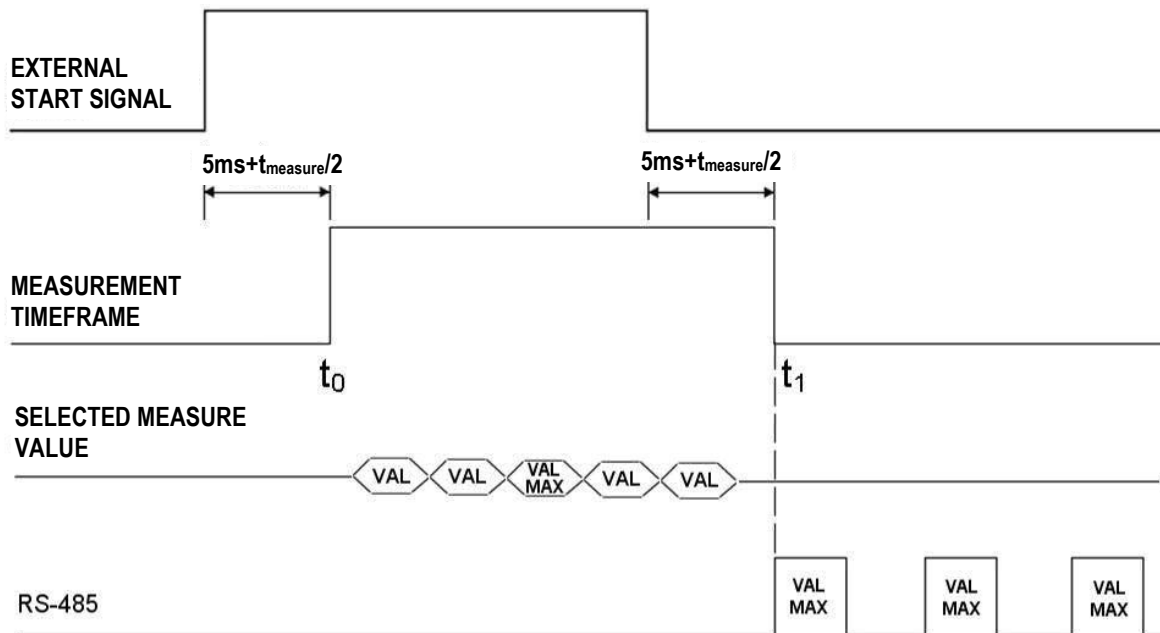

Figure 20 - LINE START/STOP

- [2](#) Synchronism Configuration: See page 19
- [3](#) Sensitivity Configuration: See page 20
- [4](#) Orientation Configuration: See page 20
- [5](#) Output Configuration: See page 20

There are 3 other configuration zones, which are described below :

- 6 **Serial Line RS-485 configuration:**
 In addition to the standard parameters (Baud rate, parity bits), the user can also select the start, end and separator character of the packet, which METRON will send (decimal, hexadecimal, binary); specifically :

| | |
|--|---|
| Decimal : 3 ASCII characters per data item | <i>Example 255 = "2", "5", "5" (0x32,0x35,0x35)</i> |
| Hexadecimal : 2ASCII characters per data item | <i>Example FF = "F", "F" (0x46,0x46)</i> |
| Binary : 1 character in binary code | |

- 7 **Data transmitted on line:** the information (data) transmitted via RS-485 serial line is as follows :

- **FBO** First beam obstructed
- **LBO** Last beam obstructed
- **CBO** Central beam obstructed
- **NBO** Number of beams obstructed
- **NCBO** Number of consecutive beams obstructed
- **BEAM STATUS** Status of each single beam represented in binary format
- **CHECKSUM** 1's complement of the 8-bit sum of the data transmitted

One or more of the above pieces of information can be selected. The following example illustrates how a data packet is composed with the configuration selected in Figure 19 and with a 30 beam light curtain:

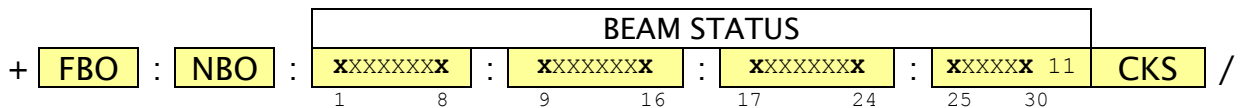

In this example, the fields **FBO** and **NBO** will respectively report the number of the first obstructed beam and the total number of occupied beams. As regards the **BEAM STATUS** fields, the characters "x" represent the status of each beam which may be:

- "0" = OBSTRUCTED
- "1" = FREE

- 8 **Transmission Mode Configuration.**

The information referred to in point 7 can be sent in the following modes:

- **CONTINUOUS**
METRON sends a new data packet as soon as the previous one has been sent (after a 10ms delay).
- **UPON REQUEST**
METRON sends a data packet when it receives a user-selected character on the RS-485 line.

- **UPON INPUT**
*METRON sends a data packet based on the chosen function for the **INPUT** signal (pin M).*
- **PERIODIC**
METRON sends a new data packet based on the period selected by the user.
- **UPON BEAM CHANGE STATUS**
METRON sends a new packet as soon as the beam condition changes.

MODEL B (2 OUT) FACTORY SETTINGS

| | |
|---------------------------------|-----------------------------|
| INPUT FUNCTION | No function |
| SYNCHRONISM | Optical |
| ORIENTATION | Normal |
| SENSITIVITY | Normal |
| STATIC OUTPUT | OUT1 active |
| CONDITIONS FOR OUT1 | NB0 >= 1 (presence control) |
| BAUD RATE | 9600 |
| PARITY | Par |
| START CHARACTER | ! |
| END CHARACTER | CR |
| SEPARATOR CHARACTER | - |
| TRANSMISSION MODE | Hexadecimal |
| TRANSMITTED DATA ON LINE | Beam Status |
| TRANSMISSION MODALITY | Continuous |

METRON B (2 OUT) configuration in RS-485 on network mode

Figure 21 shows the serial RS-485 configuration screen. Select the "RS-485 MULTI-NODE" option from the "RS-485 LINE MODE " drop-down menu .

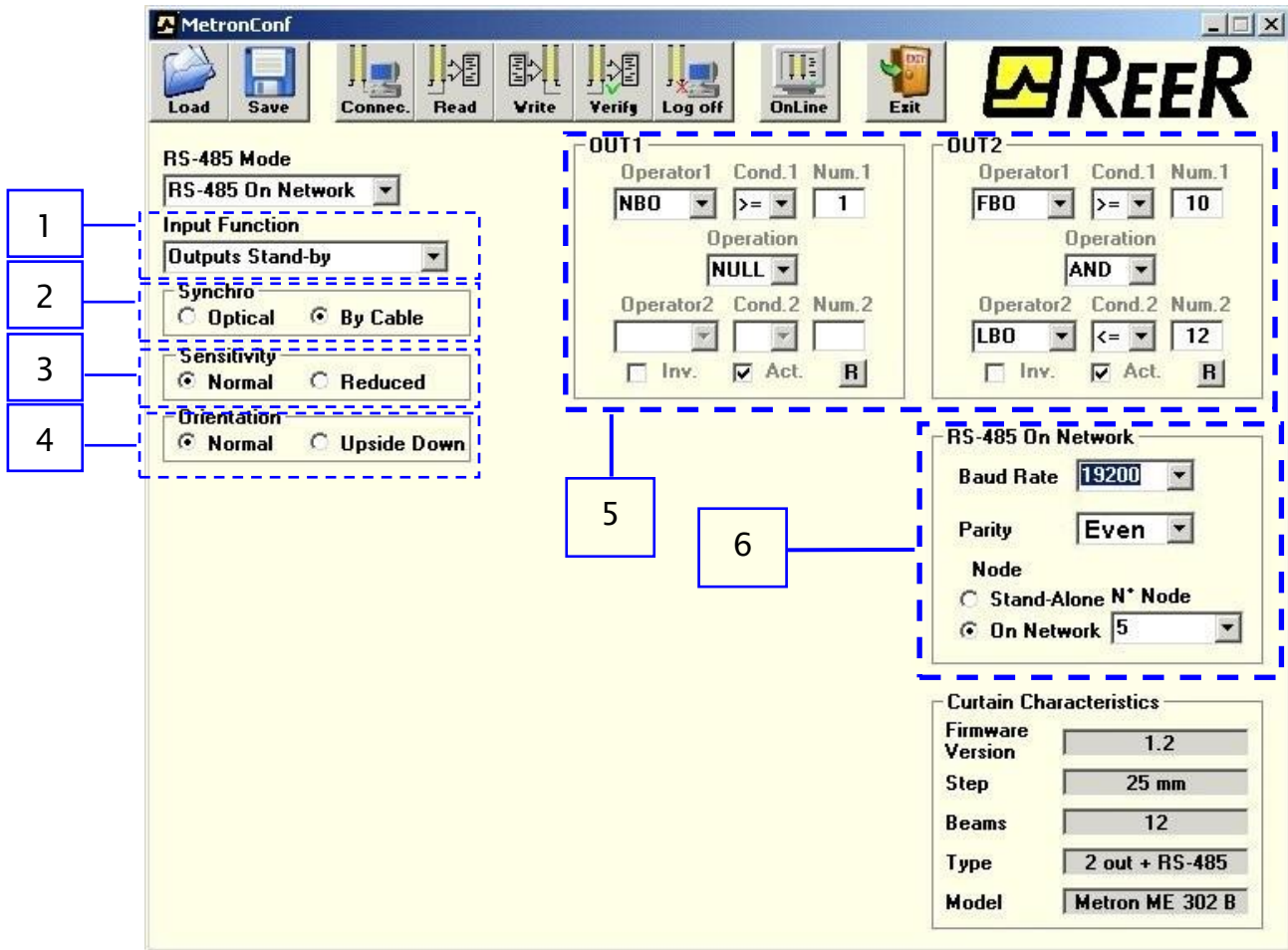



Figure 21

- 1 Input Function Configuration: See page 14
- 2 Synchronism Configuration: See page 19
- 3 Sensitivity Configuration: See page 20
- 4 Orientation Configuration: See page 20
- 5 Output Configuration: See page 20
- 6 **RS-485 MULTINODE Configuration:**
 In this mode METRON acts as a "SLAVE" element in an RS-485 network and responds to the commands described in the REER Manual, Code 8540641 "**METRON RS-485 Instruction Manual**".
 The Baud rate and the parity bit may be selected by the user.
 METRON can be configured as an individual network element or, if there are several light curtains on the network, they can be assigned a node number.

➔ Maximum number of METRON per network = 8.

Configuration saving/opening

The  icon allows the user to save the configuration as soon as it is defined.

The  icon allows the user to recall a previously saved configuration.

Send Configuration to Light Curtain

Figure 22 shows the screen which allows the configuration selection to be sent from the PC to METRON. Select the  icon to activate it.

Wait for the "WRITING CORRECTLY EXECUTED" message to appear.

It is possible to verify that the configuration present on the light curtain is the same as that represented on MetronConf using the  icon.

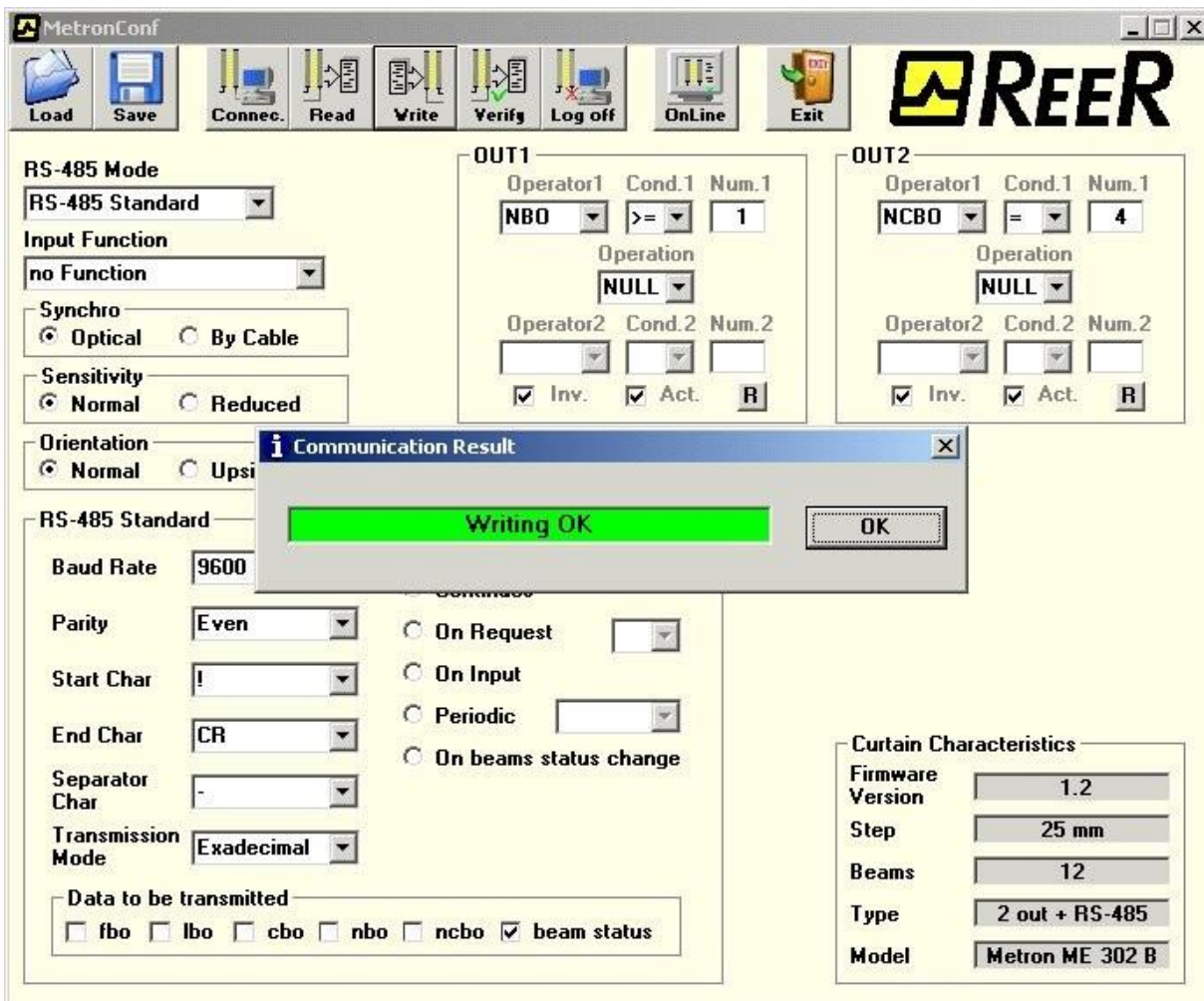



Figure 22 – Send configuration

Light Curtain Configuration Reading

Select the  icon to read the light curtain configuration; all the MetronConf interface fields will be automatically filled in.

Light Curtain Disconnection

Select the  icon to disconnect the light curtain. After approximately 10 seconds, the light curtain will become active using the configuration that was last sent.

SENT DATA PACKET CONFIGURATION ON RS-485

For detailed information regarding the composition of the packets sent on RS-485, refer to the “RS485 METRON Instructions Manual” code 8540641.

Light Curtain Status Monitoring

By pressing the "ON LINE" key (Figure 14) or by selecting the  icon the programme makes a graphic interface available to the operator, which shows operation of the light curtain in real time. Figure 23 shows the interface with the light curtain connected in synchronism by cable and no detected object. A list of the supplied information is given below:

- 1 Receiver Display (in real time)
- 2 Synchronism (optical or via cable)
- 3 Sensitivity (this should be set to "reduced" for a distance TX-RX < 50cm)
- 4 Orientation (normal or upside-down)
- 5 Model and data of the connected light curtain
- 6 Graphic representation of METRON beams (in real time)
- 7 Synchronism via cable (does not appear if it is optical synchronism)
- 8 Measurements made (in real time)
- 9 Input Status (in real time)
- 10 Output Status (in real time)

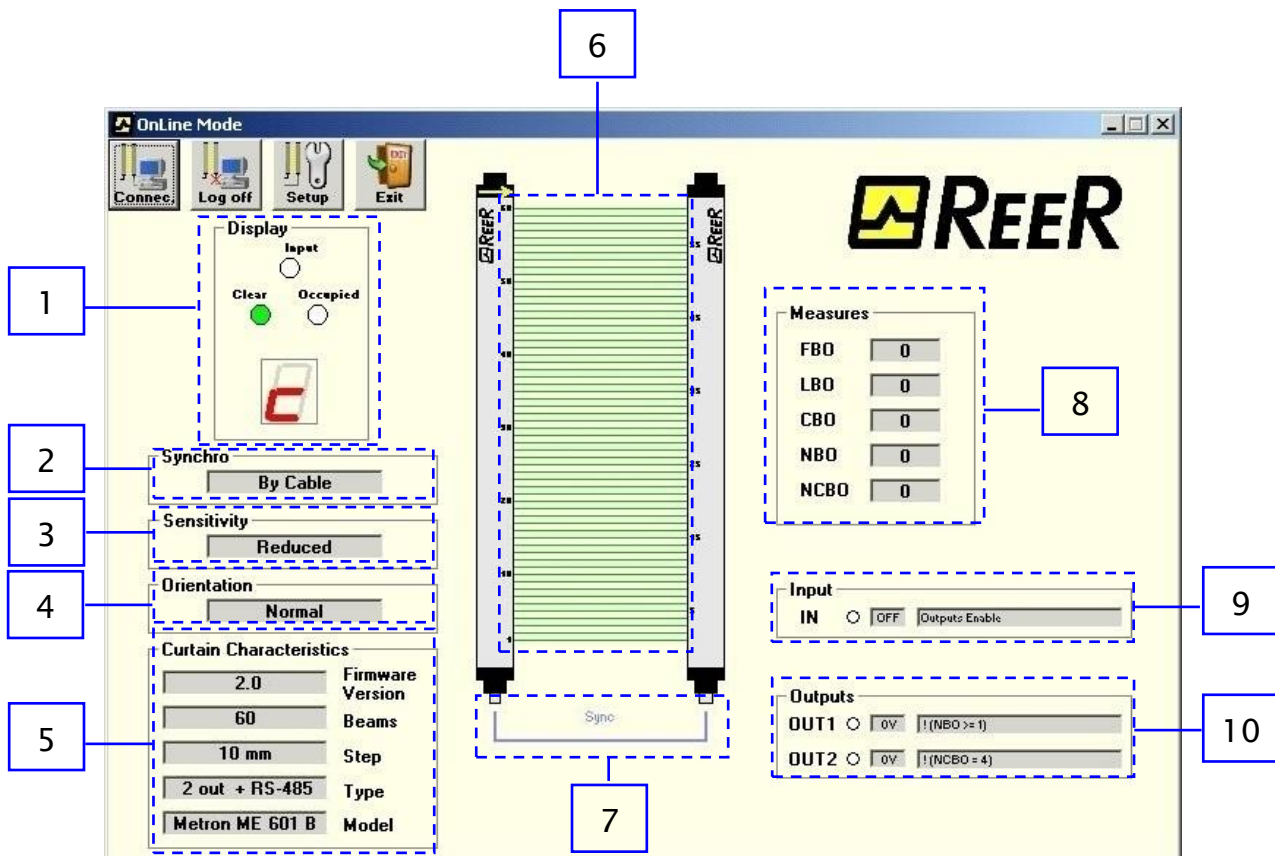

Figure 23 – Free Light Curtain (synchronism by cable)

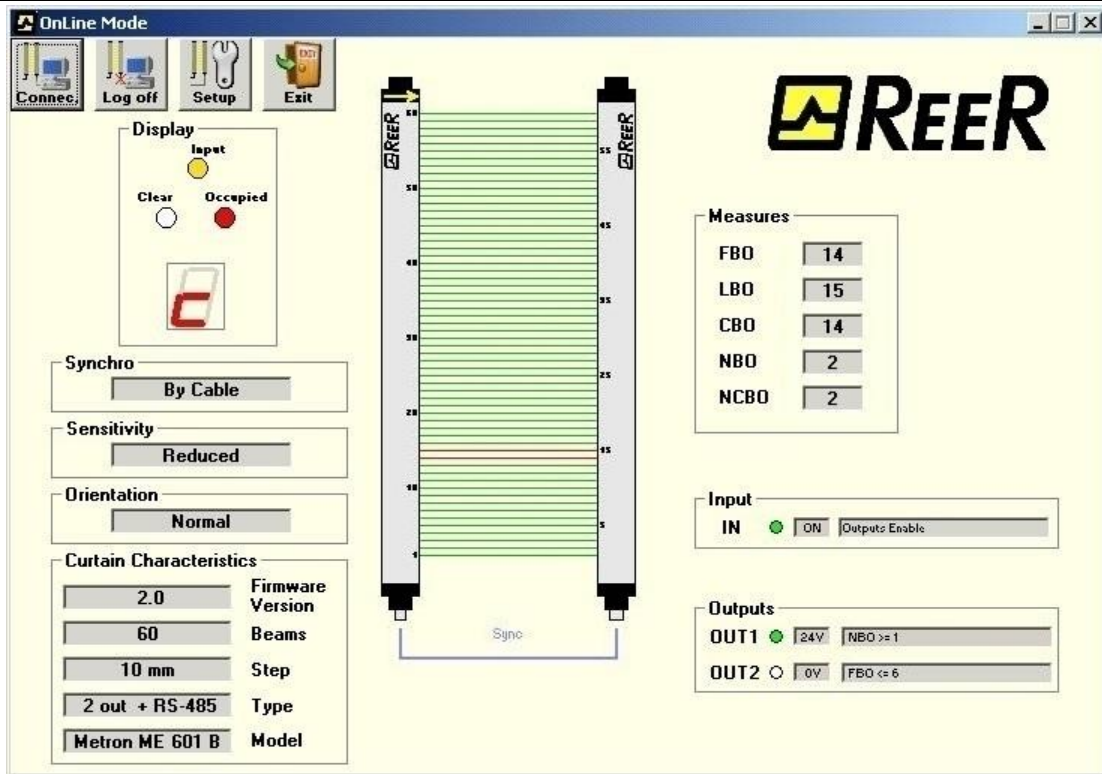

Figure 24 – Detected Object (synchronism by cable)

In this case the $FBO \geq 1$ condition which activates output 1 is met. This output is activated only when the input is enabled.

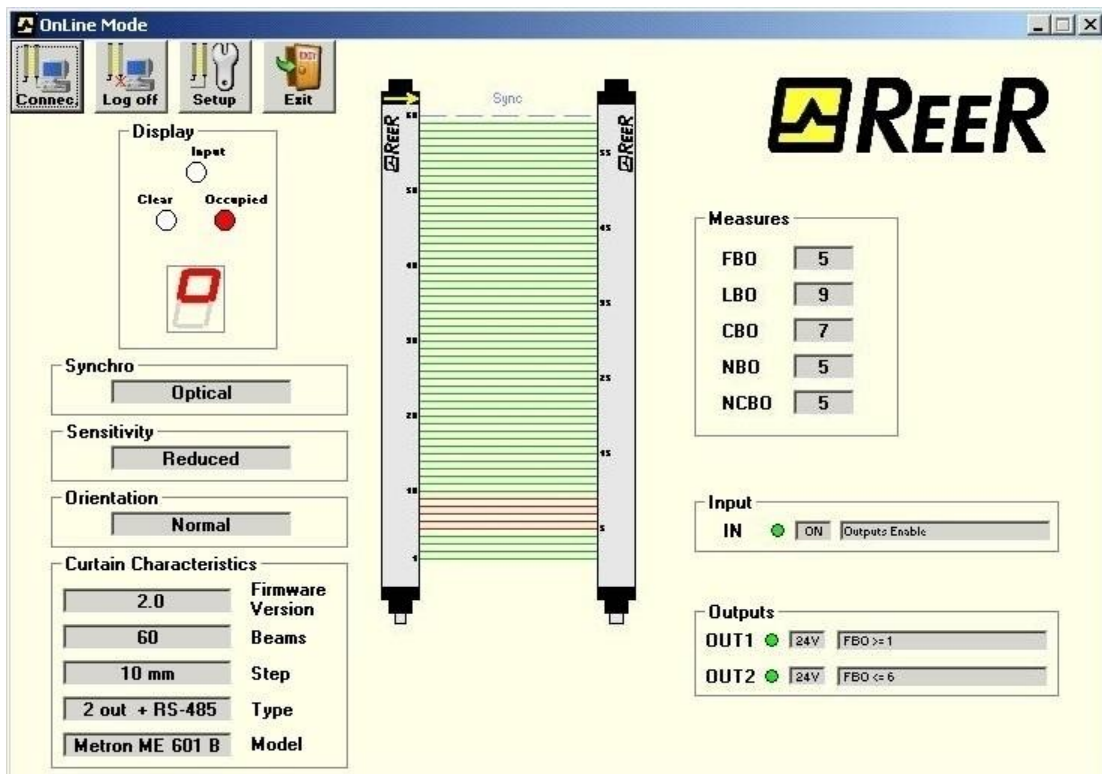

Figure 25 - 2 Detected Objects (Optical Synchronism)

In this case, the $FBO \geq 1$ condition which activates output 1 and $FBO \leq 6$ which activates output 2 is met. These outputs are activated only when input is enabled.

⚡ WHEN ON LINE MODE IS ACTIVE FOR MONITORING OF THE CURTAIN, THE TIMING DESCRIBED IN THE MANUAL BOTH FOR PACKET TRANSMISSION AND OUTPUT ACTIVATION ARE NOT GUARANTEED.

WARRANTY

REER guarantees that each newly manufactured METRON system, under conditions of normal use, is free from manufacturing defects and material defects for a period of 12 (twelve) months.

During such time, REER commits itself to eliminate any product damage, through the repair or replacement of faulty parts, completely free of charge regarding both materials and labour.

REER reserves the faculty to replace the entire faulty piece of equipment with another one of the same type or with equivalent features instead of performing repairs.

The validity of the warranty is subject to the following conditions:

- The notification of damage is forwarded by the user to REER within twelve months from the date of delivery of the product.
- The equipment and its components are in the conditions in which they were delivered by REER.
- The damages or malfunctioning was not originated directly or indirectly from:
 - Use for non-appropriate purposes;
 - Failure to comply with the usage norms;
 - Negligence, inexperience, inadequate maintenance;
 - Repairs, modifications, adaptations not performed by REER personnel, tampering, etc.;
 - Accidents or blows (even due to transportation or to acts of God);
 - Other causes independent from REER.

Repairs will be carried out by REER Laboratories, to which the material must be delivered or shipped: transportation expenses and eventual risk damages or material loss during shipping will be the Client's responsibility.

All replaced products and components will become REER's property.

REER does not recognise any other warranty or rights apart from those expressly described above; therefore, under no circumstances, can compensation requests for loss of income, suspension of activity or other factors or circumstances in any way correlated to the lack of functioning of the product or any of its parts be made.

*The precise and integral compliance to all regulations, indications and prescriptions set forward in this brochure constitutes an essential requisite for the correct functioning of the safety light curtain.
Therefore, REER s.p.a., declines all responsibility arising from the failure to comply, even partially, with these indications.*

Features subject to modification without forewarning. • Total or partial reproduction is forbidden without authorization from REER.



Dichiarazione CE di conformità
EC declaration of conformity

Torino, 21/03/2016

REER SpA
via Carcano 32
10153 – Torino
Italy

dichiara che le barriere fotoelettriche **METRON** sono dispositivi optoelettronici di misura realizzati in conformità alle seguenti Direttive Europee:

*declares that the **METRON** photoelectric barriers are Electro-sensitive Measuring Equipments compliant with the following European Directives:*

- **2014/30/EU** "Direttiva Compatibilità Elettromagnetica"
"Electromagnetic Compatibility Directive"
- **2014/35/EU** "Direttiva Bassa Tensione"
"Low Voltage Directive"

Carlo Pautasso
Direttore Tecnico
Technical Director



Simone Scaravelli
Amministratore Delegato
Managing director

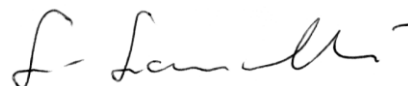

METRON



REER S.p.A.

32 via Carcano

10153 Torino Italia

Tel. +39/0112482215 r.a.

Fax +39/011859867

Internet: www.REER.it

e-mail: info@REER.it

