

 **WS19KT**

Displacement sensor with
measurement length up to
15,000 mm



- Protection class IP64
- Aluminum housing
- With optical encoder
- Optional with integrated brake

Product versions



Absolute encoder output



Incremental encoder output

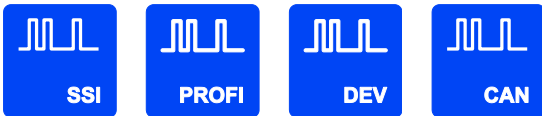

WS19KT - Cable Extension Position Sensor
Version with absolute encoder output

Specifications

Measurement range	2000 / 3000 / 5000 / 8000 / 15000 mm	1	Order options 2000 / 3000 / 5000 / 8000 / 15000																		
Output for 12 bit per revolution (4096 steps / revolution)	<table border="1"> <thead> <tr> <th></th> <th>Resolution</th> <th>Dist/Rev.</th> </tr> </thead> <tbody> <tr> <td>WS19KT-2000</td> <td>0.04 mm</td> <td>163.84 mm</td> </tr> <tr> <td>WS19KT-3000</td> <td>0.063 mm</td> <td>260.09 mm</td> </tr> <tr> <td>WS19KT-5000</td> <td>0.10 mm</td> <td>409.60 mm</td> </tr> <tr> <td>WS19KT-8000</td> <td>0.162 mm</td> <td>667.90 mm</td> </tr> <tr> <td>WS19KT-15000</td> <td>0.146 mm</td> <td>600.00 mm</td> </tr> </tbody> </table>		Resolution	Dist/Rev.	WS19KT-2000	0.04 mm	163.84 mm	WS19KT-3000	0.063 mm	260.09 mm	WS19KT-5000	0.10 mm	409.60 mm	WS19KT-8000	0.162 mm	667.90 mm	WS19KT-15000	0.146 mm	600.00 mm		
	Resolution	Dist/Rev.																			
WS19KT-2000	0.04 mm	163.84 mm																			
WS19KT-3000	0.063 mm	260.09 mm																			
WS19KT-5000	0.10 mm	409.60 mm																			
WS19KT-8000	0.162 mm	667.90 mm																			
WS19KT-15000	0.146 mm	600.00 mm																			
Output	Absolute encoder with synchronous serial output (SSI) Absolute encoder with Profibus interface Absolute encoder with Interbus interface Absolute encoder with DeviceNet interface Absolute encoder with CAN-interface Absolute encoder with CANopen interface	2	HSSI HPROF HINT HDEV HCAN HCANOP																		
Linearity	±0.05% f.s. (standard) ±0.01% f.s. (optional)	3	L01																		
Sensing device	Absolute encoder																				
Material	Aluminum measuring cable: stainless steel																				
Protection class	IP64																				
Cable fixing	M4 cable fixing Cable clip	4	M4 SB0																		
Connection	Depending on the type of encoder: connector or Bus cover																				
Temperature range	-20 ... +85 °C																				
Weight	see table "Cable forces"																				
EMC	DIN EN 61326-1:2013																				

Order code

WS19KT	-	1	-	2	-	3	-	4
--------	---	----------	---	----------	---	----------	---	----------

Order example: WS19KT – 5000 – HSSI – M4

Accessories:

Mating connector CONN-CONIN-12F-G (see page 16)

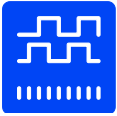

WS19KT - Cable Extension Position Sensor
Version with incremental encoder output

Specifications

		Order options
Measurement range	2000 / 3000 / 5000 / 8000 / 15000 mm	1 2000 / 3000 / 5000 / 8000 / 15000
Resolution	WS19KT-2000 25 pulses / mm WS19KT-3000 15.75 pulses / mm WS19KT-5000 10 pulses / mm WS19KT-8000 6.13 pulses / mm WS19KT15000 6.83 pulses / mm	
Output	Incremental encoder TTL compatible Incremental encoder HTL compatible	2 LD5VC PP24VC
Linearity	±0.05% f.s. (standard) ±0.01% f.s. (optional)	3 L01
Cable fixing	M4 cable fixing Cable clip	4 M4 SB0
Sensing device	Incremental encoder	
Material	Aluminum measuring cable: stainless steel	
Protection class	IP64	
Connection	Connector 12 pin	
Temperature range	-20 ... +85 °C	
Weight	see table "Cable forces"	
EMC	DIN EN 61326-1:2013	

Order code

WS19KT – **1** – **2** – **3** – **4**

Order example: WS19KT – 5000 – LD5VC – L01 – M4

Accessories:

Mating connector CONN-CONIN-12F-G (see page 16)

Cable forces typical at = 20 °C	Measurement range [mm]	Weight approx. [kg]	Maximum pull-out force [N]	Minimum pull-in force [N]
	2000	1.3	11.0	6.0
	3000	1.6	8.1	4.9
	5000	3.0	12.0	9.0
	8000	5.6	10.5	6.8
	15000	6.1	16.5	9.1

Dimensions

Measurement range 2000 ... 3000 mm

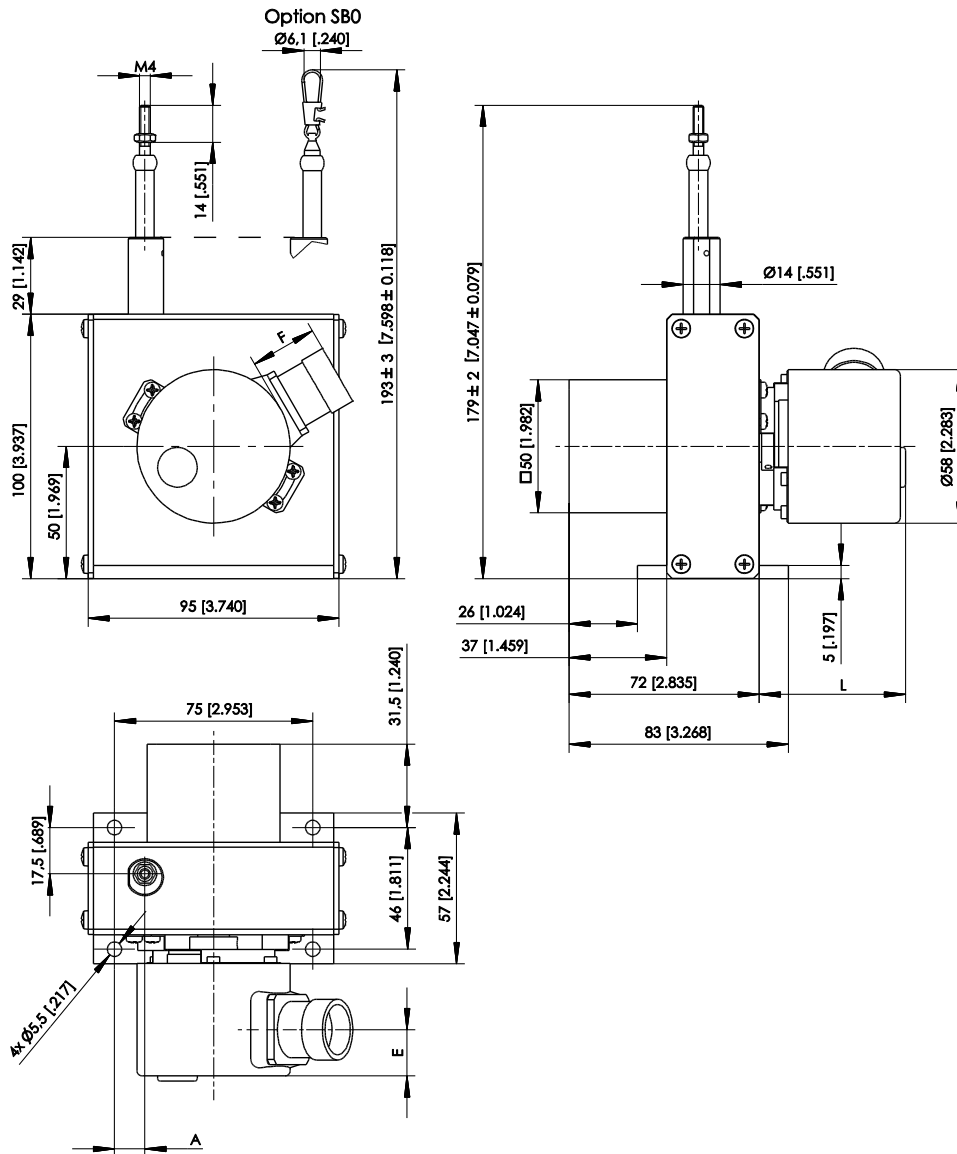

Dimensions in mm	Measurement range	A
	2000	11.5
	3000	0

Dimensions in mm [inch]

Dimensions E, F and L depending on the encoder.

Dimensions informative only. For guaranteed dimensions consult factory.

Measurement range 5000 mm, absolute encoder output, incremental encoder output

Option S80

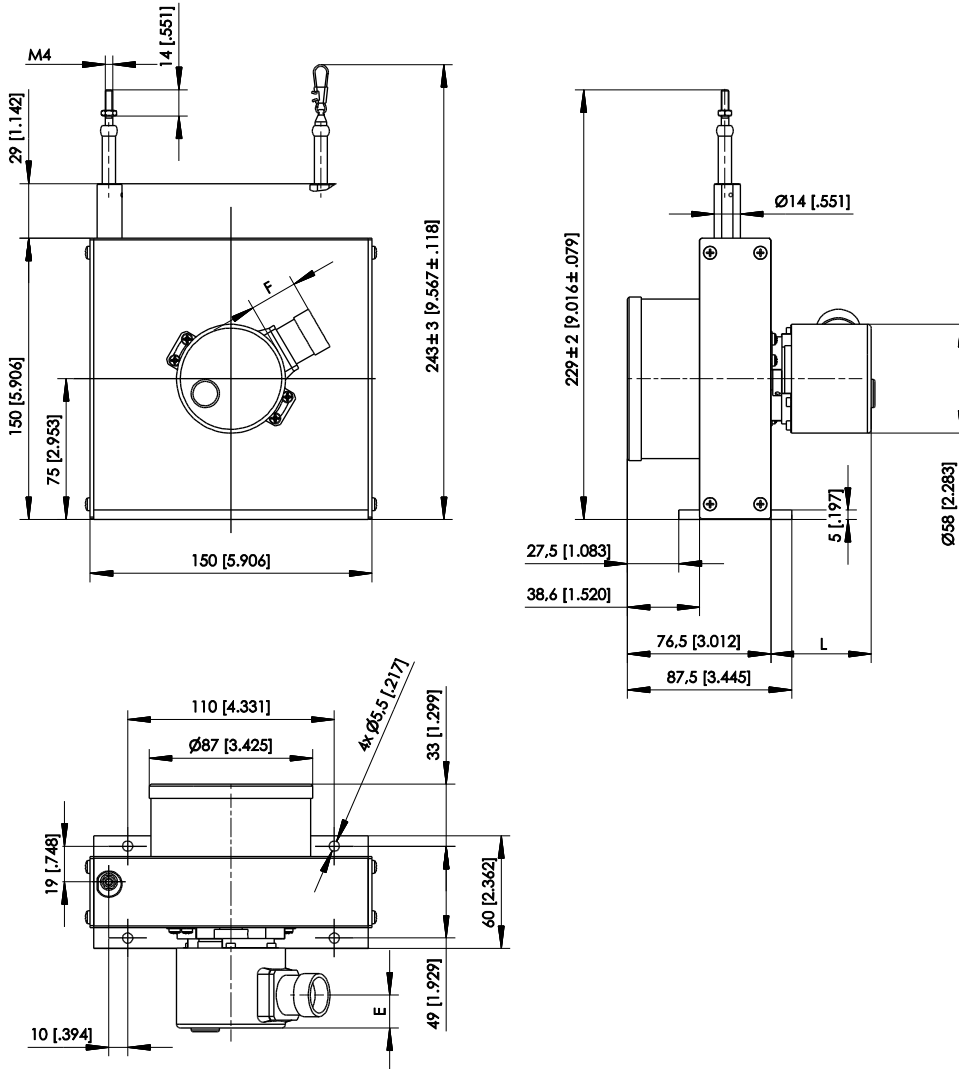

Dimensions in mm [inch]

Dimensions E, F and L depending on the encoder.

Dimensions informative only.

For guaranteed dimensions consult factory.

Measurement range 8000 mm, absolute encoder output, incremental encoder output

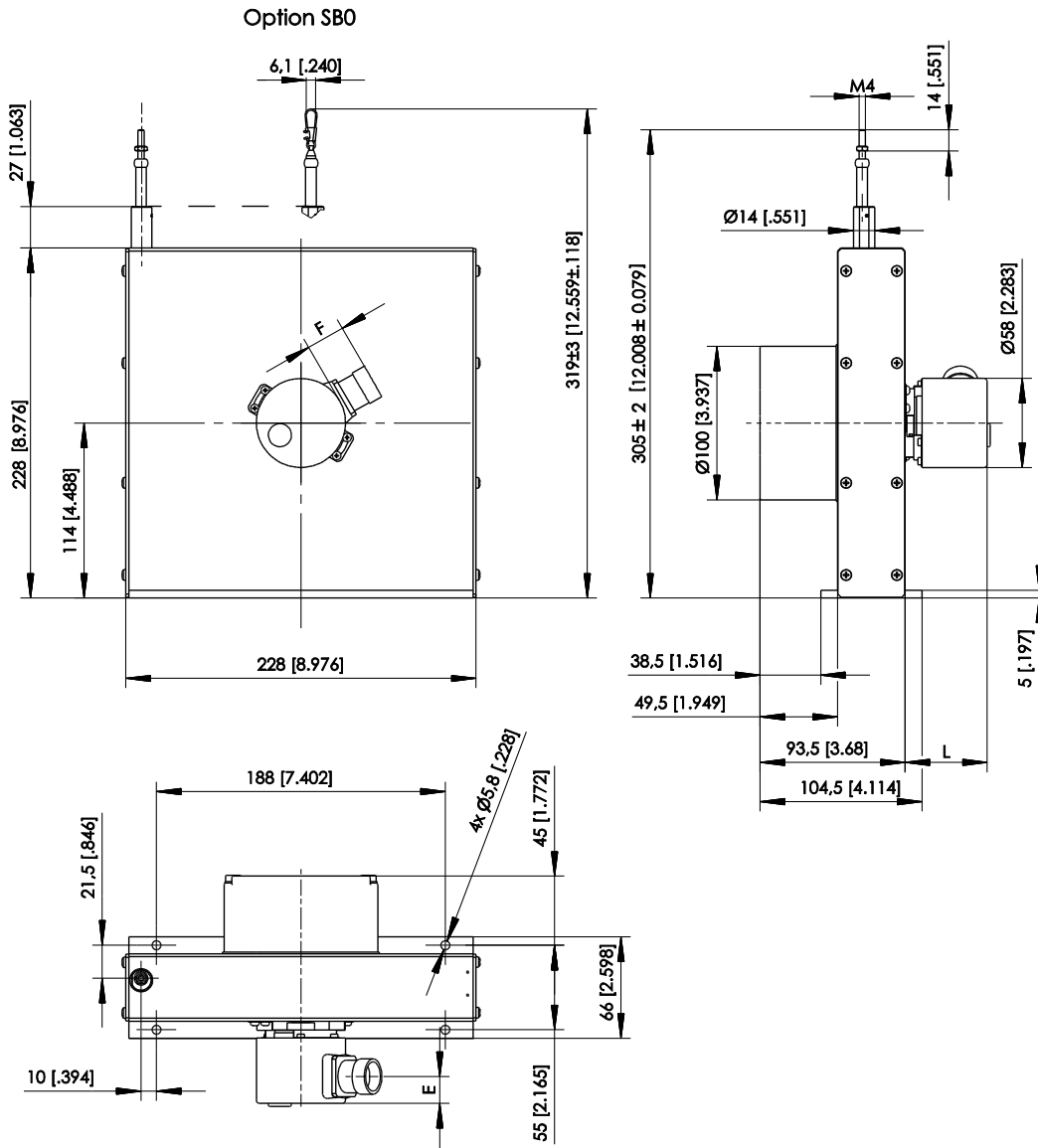

Dimensions in mm [inch]

Dimensions E, F and L depending on the encoder.

Dimensions informative only.

For guaranteed dimensions consult factory.

Measurement range 15000 mm, absolute encoder output, incremental encoder output

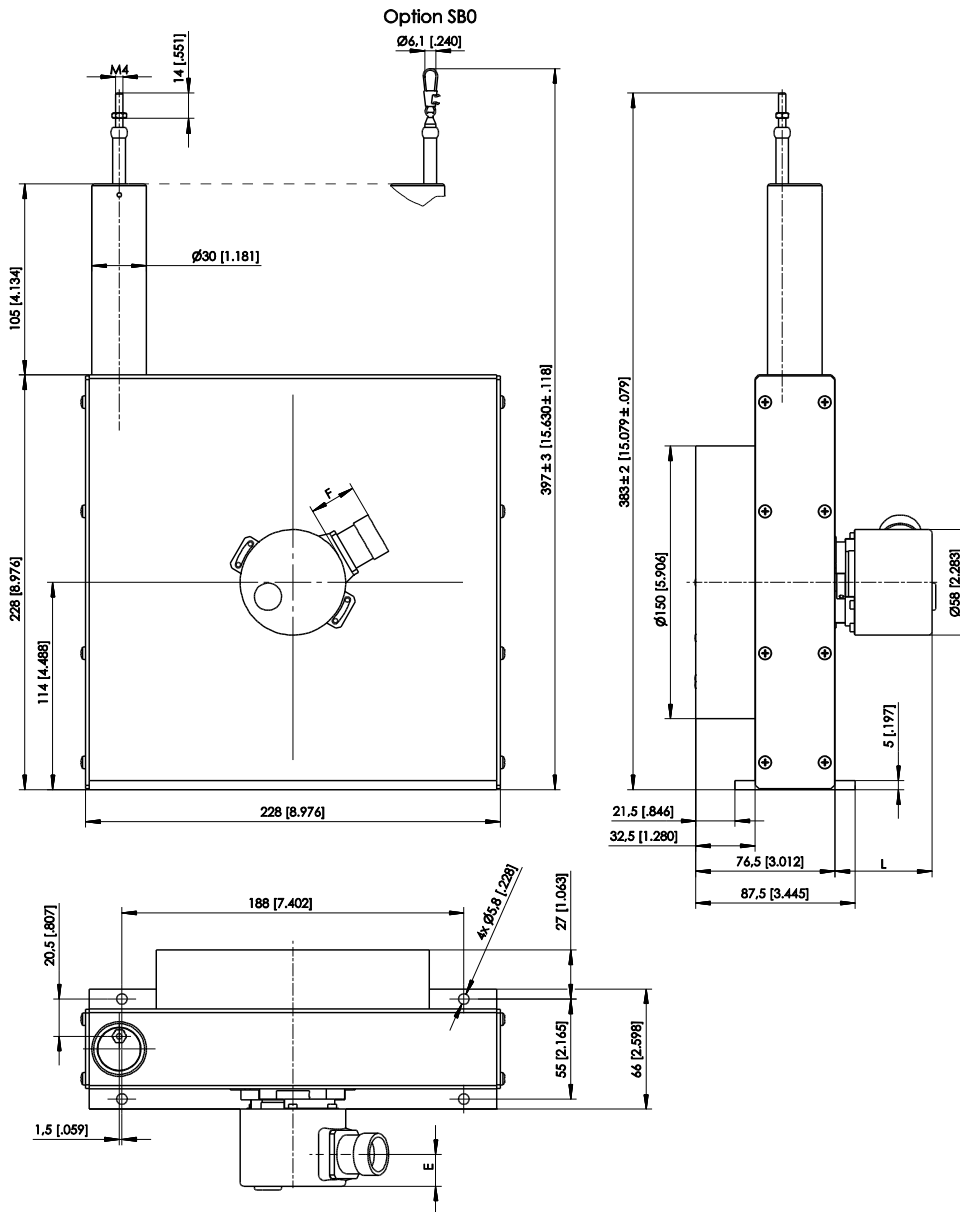

Dimensions in mm [inch]

Dimensions E, F und L depending on the encoder.

Dimensions informative only.

For guaranteed dimensions consult factory.

Output specifications

Incremental output

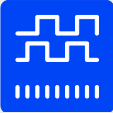
LD5VC Incremental interface 	Excitation voltage	5 V DC ±10 %
	Excitation current	150 mA max. w/o load
	Interface	Line driver RS422
	Output frequency	300 kHz max.
	Output current	20 mA per channel
	Signal level	
	U _d High bei I _d = 20 mA	≥ 2.5 V
	U _d Low bei I _d = 20 mA	≥ 0.5 V
	Transition time positive edge	< 100 ns
	Transition time negative edge	< 100 ns
	Stability (temperature)	±20 x 10 ⁻⁶ / °C f.s. (sensor-mechanism)
	Operation temperature	-20 ... +85 °C
	Protection	Short circuit, overvoltage
	EMC	DIN EN 61326-1:2013

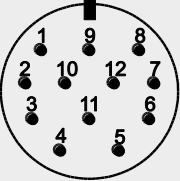
Signal wiring	Output signals	Connector pin no.	Cable color
CONN-CONIN-12F-G  View to soldering side of mating connector	Excitation +	12	white
	Excitation GND	10	brown
	Signal A	5	yellow
	Signal \bar{A}	6	pink
	Signal B (A + 90°)	8	green
	Signal \bar{B}	1	grey
	Signal Z (reference pulse)	3	blue
	Signal \bar{Z}	4	red
	Fault detection signal	7	-
	Shield	housing	-

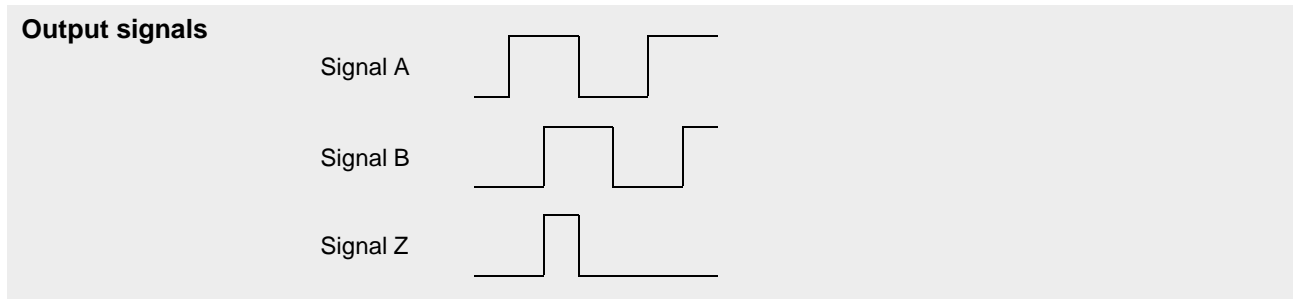

PP24VC Incremental interface 	Excitation voltage	10 ... 30 V DC
	Excitation current	150 mA max. w/o load
	Interface	Push-pull line driver (24 V-HTL)
	Output frequency	300 kHz max.
	Output current	100 mA per channel
	Signal level	
	Ud High at Id = 20 mA, Ub = 24 V	≥ 21 V
	Ud Low at Id = 20 mA, Ub = 24 V	≥ 2.8 V
	Transition time positive edge	< 200 ns
	Transition time negative edge	< 200 ns
	Stability (temperature)	±20 x 10 ⁻⁶ / °C f.s. (sensor mechanism)
	Operating temperature	Refer to output specification
	Protection	Reverse polarity, short circuit, overvoltage
	EMC	DIN EN 61326-1:2013

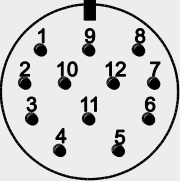
Signal wiring	Output signals	Connector pin no.	Cable color
CONN-CONIN-12F-G  View to soldering side of mating connector	Excitation +	12	white
	Excitation GND	10	brown
	Signal A	5	yellow
	Signal \bar{A}	6	pink
	Signal B (A + 90°)	8	green
	Signal \bar{B}	1	grey
	Signal Z (reference pulse)	3	blue
	Signal \bar{Z}	4	red
	Fault detection signal	7	-
	Shield	housing	-

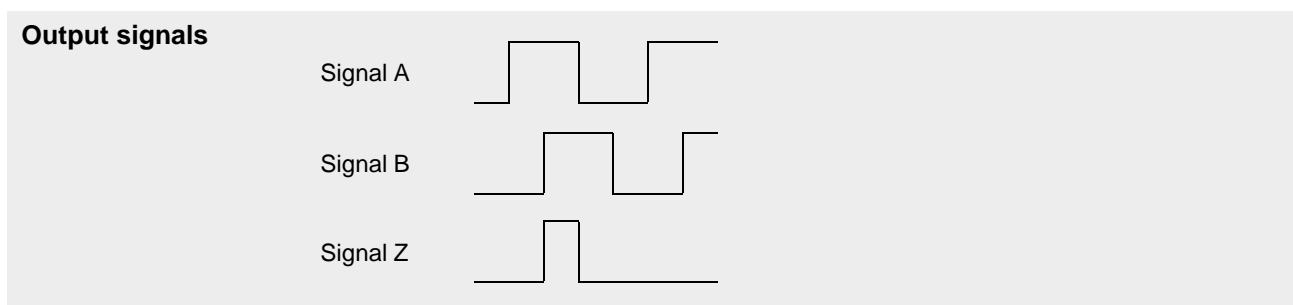

Absolute encoder output

HSSI synchronous serial 	Excitation voltage	10 ... 30 V DC
	Excitation current	100 mA
	Interface	Standard-SSI
	Lines / drivers	Clock and data / RS422
	Code	Gray
	Resolution	12 + 12 bit
	3 dB cutoff frequency	500 kHz
	Control input	$\overline{\text{DIRECTION}}$
	Preset key	Zero adjustment with optical response
	Alarm output	Alarm bit (SSI option), warning bit
	Status LED	Green = OK, red = alarm
	Connection	12 pin male socket

Data format

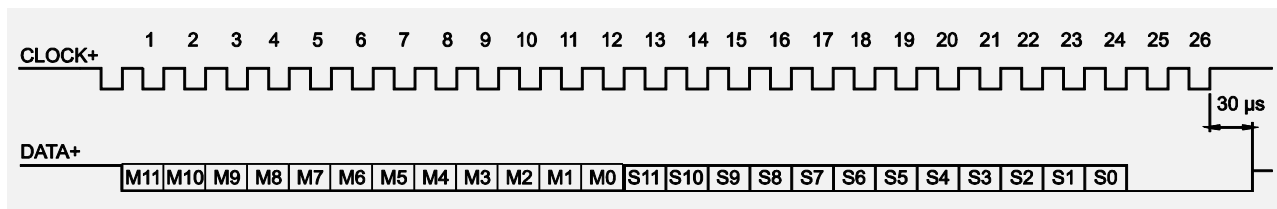

(Mx = Multiturn bits, Sx = Singleturn bits)

Transmission rate

Cable length	Baud rate	Note:
< 50 m	< 400 kHz	Extension of the cable length will reduce the maximum transmission rate.
< 100 m	< 300 kHz	
< 200 m	< 200 kHz	
< 400 m	< 100 kHz	

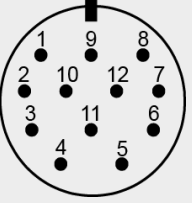
Signal wiring	Signal	Connector pin no.	Cable color
CONN-CONIN-12F-G  View to the sensor connector	Excitation +	8	white
	Excitation GND	1	brown
	CLOCK	3	yellow
	$\overline{\text{CLOCK}}$	11	green
	DATA	2	pink
	$\overline{\text{DATA}}$	10	grey
	Direction*	5	blue
	0 V Signal output	12	black

* unconnected or Excitation + = cw increasing code
0 V = cw decreasing code

HPROF Profibus 	Interface	RS485
	Excitation voltage	10 ... 30 V DC
	Excitation current	250 mA
	Protocol	Profibus DP with encoder profile C2
	Resolution	12 (10 ... 14) + 12 bit
	Output code	Binary
	Baud rate	Automatically selected between 9,6 kBaud and 12 MBaud
	Programmability	Resolution, preset, direction
	Integrated special functions	Velocity, acceleration, operating time
	Bus terminating resistor	Selectable via DIP switch
	Connection	Bus cover with T manifold
	EMC	Din EN 61326: Class A

Signal wiring	Output signals	Cable terminal no. (bus cover)
	U _b in	1
	0 V in	2
	U _B out	3
	0 V out	4
	B in	5
	A in	6
	B out	7
	A out	8

HINT Interbus 	Interface	Interbus, ENCOM profile K3 (configurable), K2
	Excitation voltage	10 ... 30 V DC
	Excitation current	250 mA
	Output code	32 Bit binary
	Baud rate	500 kBaud
	Data refresh	Every 600 µs
	Resolution	12 (10 ... 14) + 12 bit
	Programmability	Direction, preset, offset, resolution
	Connection	Bus cover with T manifold
	EMC	DIN EN 61326-1:2013

Data format K2 / K3					
	Differential signals (RS485) ENCOM profile K3, K2, 32 Bit, binary process data				
DÜ-Format	Sµpi-Adresse	0	1	2	3
(according to the Phoenix company)	Byte no.	3	2	1	0
ID-Code K2	36H (=54 dez.)				
ID-Code K3	37H (=55 dez.)				

Signal wiring	Output signals	Cable terminal no. (bus cover)
	U _b +	1
	GND	2
	DI1	4
	$\overline{DI1}$	6
	D01	3
	$\overline{D01}$	5
	D02	7
	$\overline{D02}$	8
	DI2	9
	$\overline{D02}$	10
	RBST	11
	GND	12

HDEV DeviceNet 	Interface	CAN highspeed according to ISO/DIS 11898 CAN specification 2.0 A (11 bit identifier)
	Excitation voltage	10 ... 30 V DC
	Excitation current	250 mA
	Protocol	DeviceNet according rev. 2.0, programmable encoder
	Resolution	12 (10 ... 14) + 12 bit
	Output code	Binary
	MAC-ID	Selectable via DIP switch
	Date refresh	Every 5 ms
	Baud rate	Selectable via DIP switch: 125 kBaud, 250 kBaud, 500 kBaud
	Programmability	Resolution, preset, direction
	Bus terminating resistor	Selectable via DIP switch
	Connection	Bus cover with T manifold
	EMC	DIN EN 61326-1:2013

Recommended transmission

Characteristic impedance	135 ... 165 Ω (3 ... 20 MHz)
Operating capacity	< 30 pF
Loop resistance	< 110 Ω/km
Wire diameter	> 0.63 mm
Wire width	> 0.34 mm ²

Transmission rate

Segment length	Kbit/s
500 m	125
250 m	250
100 m	500

Signal wiring	Output signals	Cable terminal no. (bus cover)
	U _b in	1
	0 V in	2
	CAN-L	4
	CAN-H	6
	Drain	3
	Drain	5
	CAN-H	7
	CAN-L	8

HCAN / HCANOP CANopen / CAN Layer 2 	Interface	CAN highspeed according to ISO/DIS 11898
	Excitation voltage	10 ... 30 V DC
	Excitation current	250 mA
	Protocol	CANopen according DS301 with encoder profile DSP406, programmable encoder according class C2
	Resolution	12 (10 ... 14) + 12 bit
	Output code	Binary
	Data refresh	Every millisecond (selectable), on request
	Baud rate	Selectable 10 up to 1000 kbit/s
	Base identifier	Selectable via DIP switch
	Programmability	CANopen: direction, resolution, preset, offset CAN L2: direction, limit values
	Integrated special functions	CANopen: velocity, acceleration, rotary axis, limit values CAN L2: direction, limit values
	Connection	Bus cover with T manifold
	EMC	DIN EN 61326-1:2013

Signal wiring	Output signals	Cable terminal no. (bus cover)
	U _b in	1
	0 V in	2
	CAN in – (dominant L)	4
	CAN in + (dominant H)	6
	CAN GND in	3
	CAN GND out	5
	CAN out + (dominant H)	7
	CAN out – (dominant L)	8
	0 V out	9
	U _b out	10

Accessories
Plug-in connector CONIN, 12 pin (straight coupling)

Order code:

CONN-CONIN-12F-G

Cable diameter
max. 6 ... 8 mm

