

# RF1V Force Guided Relays

# SF1V Relay Sockets



IDEC CORPORATION

# Enables flexible construction of safety circuits

## Complies with International Standards

Force guided contact mechanism  
(EN50205 Type A TÜV approved)



## Fast Response Time

Response time of 8 ms.  
Ensures safety by turning the load off quickly.  
(200 m/s<sup>2</sup> minimum)

## High Shock Resistance

High shock resistant suitable for use in machine tools and in environments subjected to vibration and shocks.

## Clear Visibility

Available with a built-in LED.

## Compact and Slim

Compact size enables size reduction of PC board.  
4-pole type: 13W × 40D × 24H mm  
6-pole type: 13W × 50D × 24H mm

## Socket Variation

PC board mount and DIN rail mount sockets are available.



PC board mount

DIN rail mount

## What is a force guided relay?

Relays used in safety circuits to detect failures such as contact welding and damage to the contact spring.

Contacts of a force guided relay are forced to open and close by a guide connected to the armature. Due to requirements of standard EN50205, a force guided relay has independent NO and NC contacts. If a NO contact welds, a NC contact will not close even when the relay coil is turned off (de-energized) and must maintain a gap of at least 0.5 mm. Furthermore, if a NC contact welds, a NO contact will not close when the relay is turned on (energized) and must maintain a gap of at least 0.5 mm. (General-purpose relays do not have the above characteristics.)

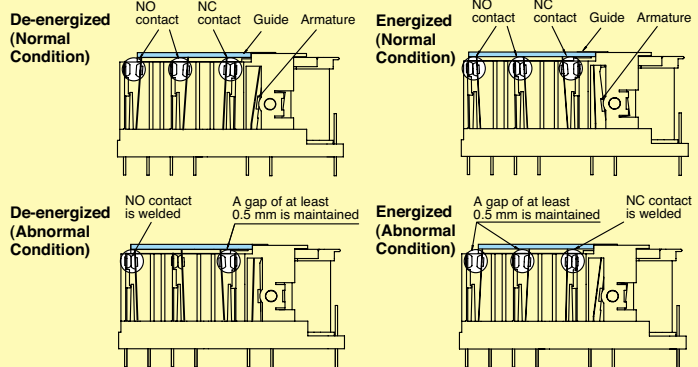
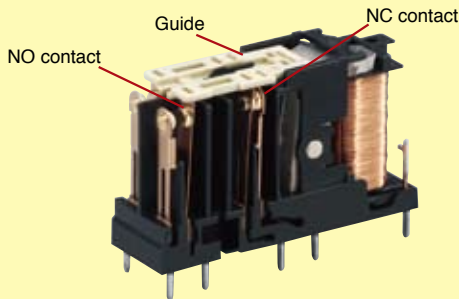

## Applications

Force guided relays are used in safety circuits in combination with interlock switches, light curtains, and emergency stop switches to control outputs. They can also be used to expand outputs for safety relay modules and safety controllers.

## Output expansion for safety relay modules and safety controllers

### • HR1S Safety Relay Module

Cost effective and easy method to expand mechanical contact outputs.

#### • Circuit Example

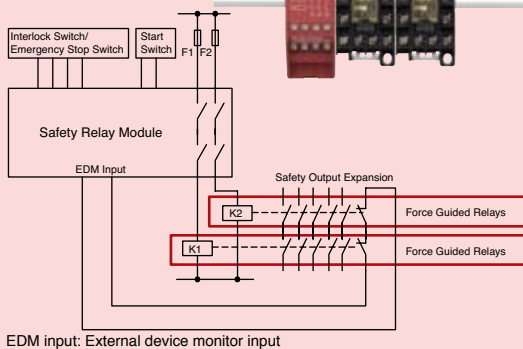

EDM input: External device monitor input

### • FS1A Safety Controller

Solid state safety outputs of safety controllers can be converted to mechanical contact outputs.

#### • Circuit Example

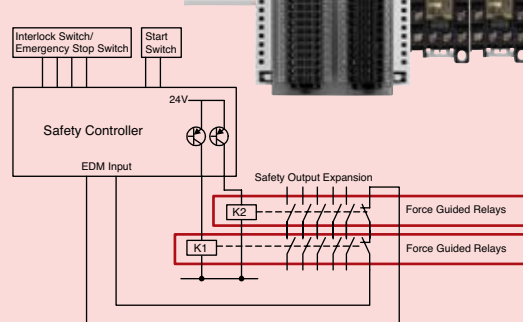

# RF1V Force Guided Relays / SF1V Relay Sockets

## Compact and EN compliant RF1V force guided relays.

- Force guided contact mechanism (EN50205 Type A TÜV approved)
- Contact configuration
  - 4-pole (2NO-2NC, 3NO-1NC)
  - 6-pole (4NO-2NC, 5NO-1NC, 3NO-3NC)
- Built-in LED indicator available.
- Fast response time (8 ms maximum).
- High shock resistance (200 m/s<sup>2</sup> minimum)
- Finger-safe DIN rail mount socket and PC board mount socket.

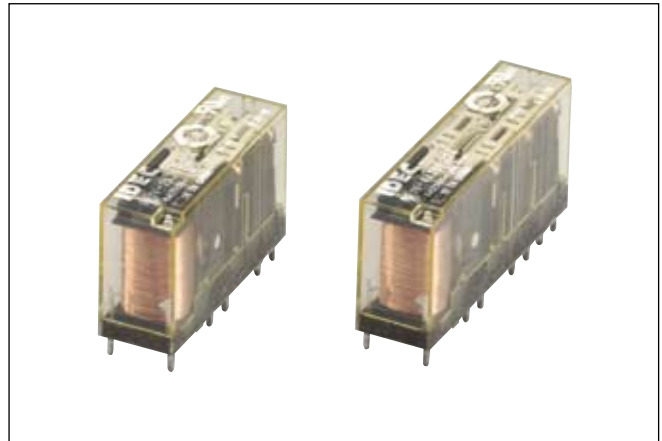

Applicable Standard	Marking	Certification Organization / File No.
UL508 CSA C22.2 No.14		UL/c-UL File No. E55996
EN50205 EN61810-1		TÜV SÜD

## Types

### • Force Guided Relays

Contact	Rated Coil Voltage	Without LED Indicator		With LED Indicator	
		Ordering Type No.		Ordering Type No.	
4-pole	2NO-2NC	12V DC	RF1V-2A2B-D12	RF1V-2A2BL-D12	RF1V-2A2BL-D12
		24V DC	RF1V-2A2B-D24	RF1V-2A2BL-D24	RF1V-2A2BL-D24
		48V DC	RF1V-2A2B-D48	RF1V-2A2BL-D48	RF1V-2A2BL-D48
	3NO-1NC	12V DC	RF1V-3A1B-D12	RF1V-3A1BL-D12	RF1V-3A1BL-D12
		24V DC	RF1V-3A1B-D24	RF1V-3A1BL-D24	RF1V-3A1BL-D24
		48V DC	RF1V-3A1B-D48	RF1V-3A1BL-D48	RF1V-3A1BL-D48
6-pole	4NO-2NC	12V DC	RF1V-4A2B-D12	RF1V-4A2BL-D12	RF1V-4A2BL-D12
		24V DC	RF1V-4A2B-D24	RF1V-4A2BL-D24	RF1V-4A2BL-D24
		48V DC	RF1V-4A2B-D48	RF1V-4A2BL-D48	RF1V-4A2BL-D48
	5NO-1NC	12V DC	RF1V-5A1B-D12	RF1V-5A1BL-D12	RF1V-5A1BL-D12
		24V DC	RF1V-5A1B-D24	RF1V-5A1BL-D24	RF1V-5A1BL-D24
		48V DC	RF1V-5A1B-D48	RF1V-5A1BL-D48	RF1V-5A1BL-D48
	3NO-3NC	12V DC	RF1V-3A3B-D12	RF1V-3A3BL-D12	RF1V-3A3BL-D12
		24V DC	RF1V-3A3B-D24	RF1V-3A3BL-D24	RF1V-3A3BL-D24
		48V DC	RF1V-3A3B-D48	RF1V-3A3BL-D48	RF1V-3A3BL-D48

### • Sockets

Types	No. of Poles	Ordering Type No.
DIN Rail Mount Sockets	4	SF1V-4-07L
	6	SF1V-6-07L
PC Board Mount Sockets	4	SF1V-4-61
	6	SF1V-6-61

### Certification for Sockets

Applicable Standard	Marking	Certification Organization / File No.
UL508 CSA C22.2 No.14		UL/c-UL File No. E62437
EN147000 EN147100		TÜV SÜD
		EC Low Voltage Directive (DIN rail mount sockets only)

## Coil Ratings

Contact	Rated Coil Voltage (V)	Rated Current (mA) ±10% (at 20°C) (Note 1)	Coil Resistance (Ω) ±10% (at 20°C)	Operating Characteristics (at 20°C)			Power Consumption			
				Pickup Voltage	Dropout Voltage	Maximum Continuous Applied Voltage (Note 2)				
4-pole	2NO-2NC	12V DC	30	75% maximum	10% minimum	110%	Approx. 0.36W			
		24V DC	15							
		48V DC	7.5							
	3NO-1NC	12V DC	30							
		24V DC	15							
		48V DC	7.5							
6-pole	4NO-2NC	12V DC	41.7				288	1152	4608	Approx. 0.5W
		24V DC	20.8							
		48V DC	10.4							
	5NO-1NC	12V DC	41.7							
		24V DC	20.8							
		48V DC	10.4							
	3NO-3NC	12V DC	41.7							
		24V DC	20.8							
		48V DC	10.4							

Note 1: For relays with LED indicator, the rated current increases by approx. 2 mA.

Note 2: Maximum continuous applied voltage is the maximum voltage that can be applied to relay coils.

# RF1V Force Guided Relays / SF1V Relay Sockets

## Relay Specifications

Number of Poles		4-pole		6-pole		
Contact Configuration		2NO-2NC	3NO-1NC	4NO-2NC	5NO-1NC	3NO-3NC
Contact Resistance (initial value) (Note 1)		100 mΩ maximum				
Contact Material		AgSnO <sub>2</sub> (Au flashed)				
Rated Load (resistive load)		6A 250V AC, 6A 30V DC				
Allowable Switching Power (resistive load)		1500 VA, 180W				
Allowable Switching Voltage		250V AC, 30V DC				
Allowable Switching Current		6A				
Minimum Applicable Load (Note 2)		5V DC, 1 mA (reference value)				
Power Consumption (approx.)		0.36W		0.5W		
Insulation Resistance		1000 MΩ minimum (500V DC megger, same measurement positions as the dielectric strength)				
Dielectric Strength	Between contact and coil	4000V AC, 1 minute				
	Between contacts of different poles	2500V AC, 1 minute Between contacts 7-8 and 9-10		2500V AC, 1 minute Between contacts 7-8 and 11-12 Between contacts 9-10 and 13-14 Between contacts 11-12 and 13-14		
		4000V AC, 1 min. Between contacts 3-4 and 5-6 Between contacts 3-4 and 7-8 Between contacts 5-6 and 9-10		4000V AC, 1 min. Between contacts 3-4 and 5-6 Between contacts 3-4 and 7-8 Between contacts 5-6 and 9-10 Between contacts 7-8 and 9-10		
	Between contacts of the same pole	1500V AC, 1 minute				
Operate Time (at 20°C)		20 ms maximum (at the rated coil voltage, excluding contact bounce time)				
Response Time (at 20°C) (Note 3)		8 ms maximum (at the rated coil voltage, excluding contact bounce time)				
Release Time (at 20°C)		20 ms maximum (at the rated coil voltage, excluding contact bounce time)				
Vibration Resistance	Operating Extremes	10 to 55 Hz, amplitude 0.75 mm				
	Damage Limits	10 to 55 Hz, amplitude 0.75 mm				
Shock Resistance	Operating Extremes (half sine-wave pulse: 11 ms)	200 m/s <sup>2</sup> , when mounted on DIN rail mount socket: 150 m/s <sup>2</sup>				
	Damage Limits (half sine-wave pulse: 6 ms)	1000 m/s <sup>2</sup>				
Electrical Life		250V AC 6A resistive load: 100,000 operations minimum (operating frequency 1200 per hour) 30V DC 6A resistive load: 100,000 operations minimum (operating frequency 1200 per hour) 250V AC 1A resistive load: 500,000 operations minimum (operating frequency 1800 per hour) 30V DC 1A resistive load: 500,000 operations minimum (operating frequency 1800 per hour) [AC 15] 240V AC 2A inductive load: 100,000 operations minimum (operating frequency 1200 per hour, cos φ = 0.3) [DC 13] 24V DC 1A inductive load: 100,000 operations minimum (operating frequency 1200 per hour, L/R = 48 ms)				
Mechanical Life		10 million operations minimum (operating frequency 10,800 operations per hour)				
Operating Temperature (Note 4)		-40 to +85°C (no freezing)				
Operating Humidity		5 to 85%RH (no condensation)				
Storage Temperature		-40 to +85°C				
Operating Frequency (rated load)		1200 operations per hour				
Weight (approx.)		20g		23g		

Note 1: Measured using 6V DC, 1A voltage drop method.

Note 2: Failure rate level P (reference value)

Note 3: Response time is the time until NO contact opens, after the coil voltage is turned off.

Note 4: When using at 70 to 85°C, reduce the switching current by 0.1A/°C.

## Socket Specifications

Type	SF1V-4-07L	SF1V-6-07L	SF1V-4-61	SF1V-6-61
Rated Current	6A			
Rated Voltage	250V AC/DC			
Insulation Resistance	1000 MΩ minimum (500V DC megger, between terminals)			
Dielectric Strength	2500V AC, 1 minute (between terminals)			
Screw Terminal Style	M3 slotted Phillips screw		—	
Applicable Wire	0.7 to 1.65 mm <sup>2</sup> (18 AWG to 14 AWG)		—	
Recommended Screw Tightening Torque	0.5 to 0.8 N·m		—	
Terminal Strength	Wire tensile strength: 50N min.		—	
Vibration Resistance	Damage limits: 10 to 55 Hz, amplitude 0.75 mm Resonance: 10 to 55 Hz, amplitude 0.75 mm			
Shock Resistance	1000 m/s <sup>2</sup>			
Operating Temperature (Note)	-40 to +85°C (no freezing)			
Operating Humidity	5 to 85% RH (no condensation)			
Storage Humidity	-40 to +85°C			
Degree of Protection	IP20 (finger-safe screw terminals)		—	
Weight (approx.)	40g	55g	9g	10g

Note: When using at 70 to 85°C, reduce the switching current by 0.1A/°C.

## Applicable Crimping Terminals

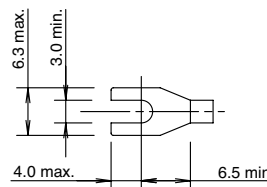

Note: Ring tongue terminals cannot be used.

# RF1V Force Guided Relays / SF1V Relay Sockets

## Accessories

Item	Appearance	Specifications	Type No.	Ordering Type No.	Package Quantity	Remarks
DIN Rail		Aluminum Weight: Approx. 200g	BAA1000	BAA1000PN10	10	Length: 1m Width: 35 mm
		Steel Weight: Approx. 320g	BAP1000	BAP1000PN10	10	
		Aluminum Weight: Approx. 250g	BNDN1000	BNDN1000	1	North American standard product Length: 1m Width: 35 mm
End Clip		Metal (zinc plated steel) Weight: Approx. 15g	BNL5	BNL5PN10	10	-
			BNL6	BNL6PN10	10	

## Characteristics

- Maximum Switching Capacity
- Electrical Life Curve

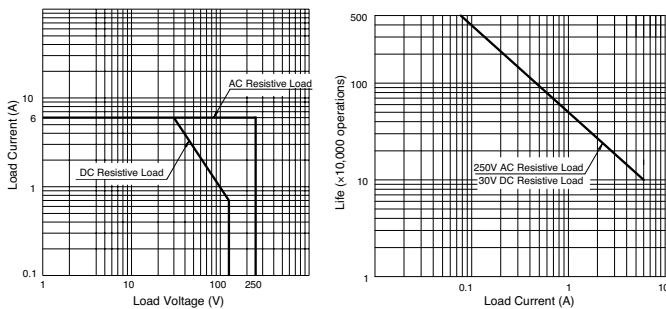

## Notes on Contact Gaps except Welded Contacts

Example: RF1V-2A2B-D24

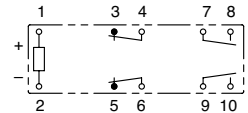

- If the NO contact (7-8 or 9-10) welds, the NC contact (3-4 or 5-6) remains open even when the relay coil is de-energized, maintaining a gap of 0.5 mm. The remaining unwelded NO contact (9-10 or 7-8) is either open or closed.
- If the NC contact (3-4 or 5-6) welds, the NO contact (7-8 or 9-10) remains open even when the relay coil is energized, maintaining a gap of 0.5 mm. The remaining unwelded NC contact (5-6 or 3-4) is either open or closed.

## RF1V Dimensions

- RF1V (4-pole)

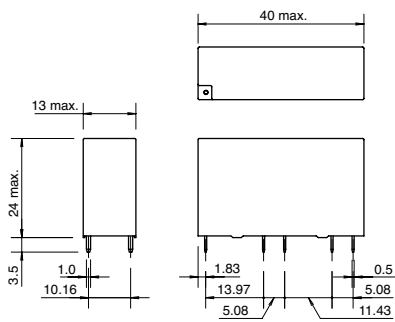

- RF1V (6-pole)

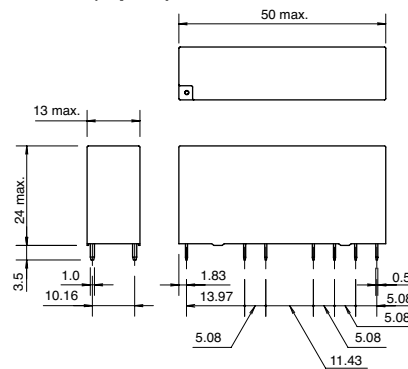

## PC Board Terminal Type Mounting Hole Layout (Bottom View)

- RF1V (4-pole)

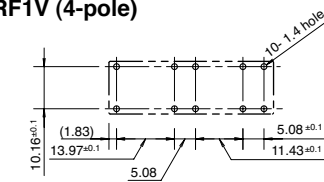

- RF1V (6-pole)

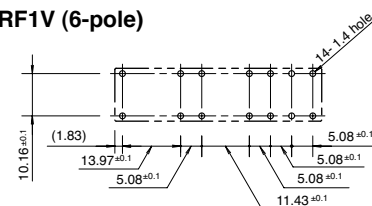

## Internal Connection (Bottom View)

- RF1V (4-pole)

Without LED Indicator

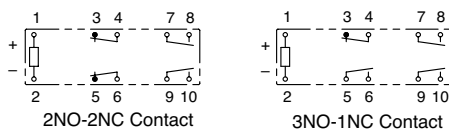

- RF1V (6-pole)

Without LED Indicator

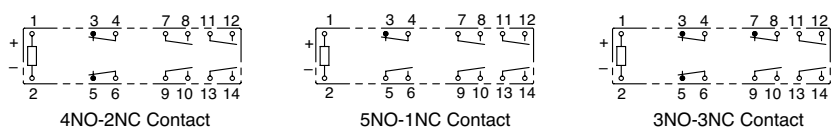

With LED Indicator

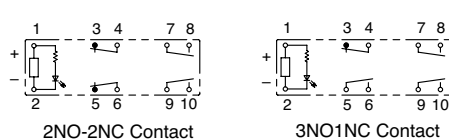

With LED Indicator

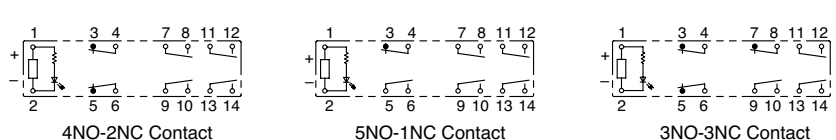

# RF1V Force Guided Relays / SF1V Relay Sockets

## SF1V DIN Rail Mount Socket Dimensions

### •SF1V-4-07L (4-pole)

(Internal Connection)

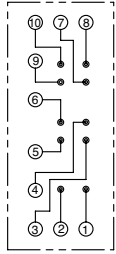

(Top View)

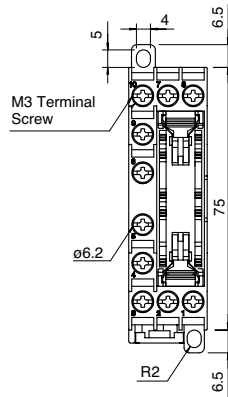

### •SF1V-6-07L (6-pole)

(Internal Connection)

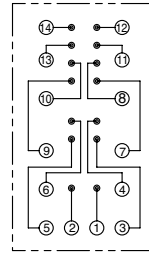

(Top View)

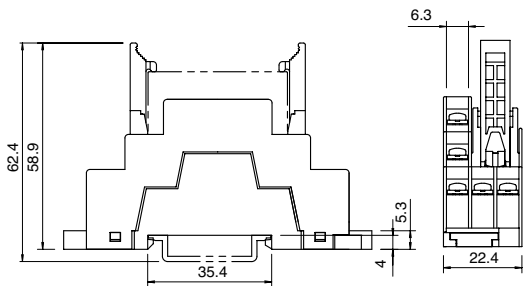
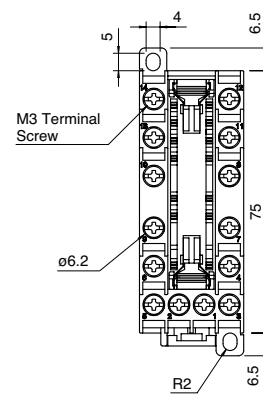

(Panel Mounting Hole Layout)

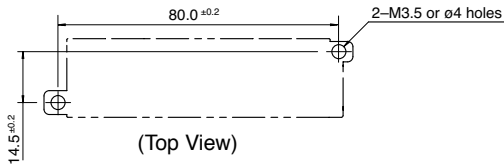

(Top View)

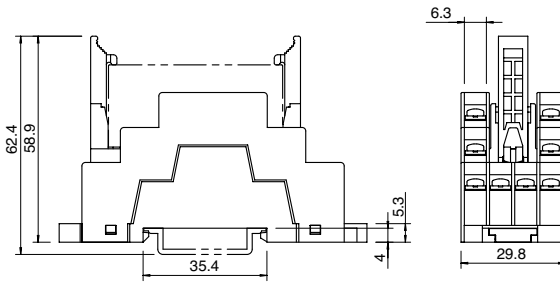

(Panel Mounting Hole Layout)

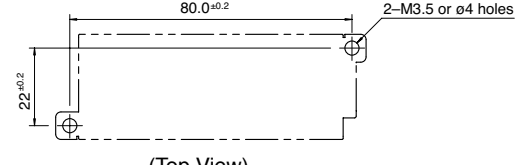

(Top View)

## SF1V PC Board Mount Sockets

### •SF1V-4-61 (4-pole)

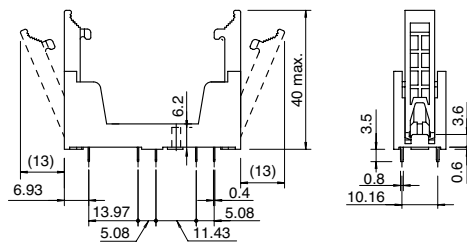
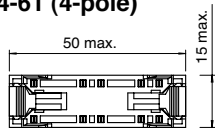

• PC Board Mounting Hole Layout / Terminal Arrangement (Bottom View)

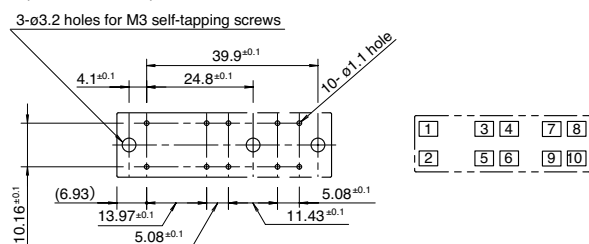

### •SF1V-6-61 (6-pole)

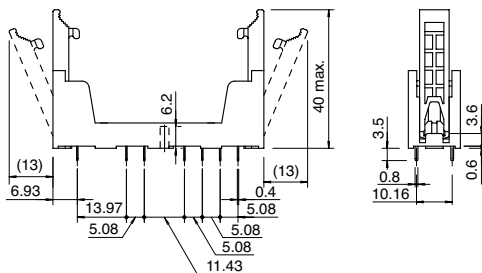
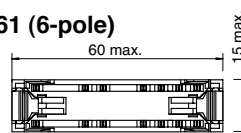

• PC Board Mounting Hole Layout / Terminal Arrangement (Bottom View)

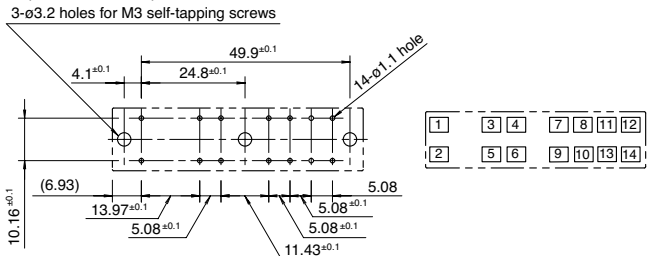

All dimensions in mm.



## Instructions

### 1. Driving Circuit for Relays

- To make sure of correct relay operation, apply rated voltage to the relay coil. Pickup and dropout voltages may differ according to operating temperature and conditions.
- Input voltage for DC coil:  
A complete DC voltage is best for the coil power to make sure of stable operation. When using a power supply containing a ripple voltage, suppress the ripple factor within 5%. When power is supplied through a rectifications circuit, relay operating characteristics, such as pickup voltage and dropout voltage, depend on the ripple factor. Connect a smoothing capacitor for better operating characteristics as shown below.

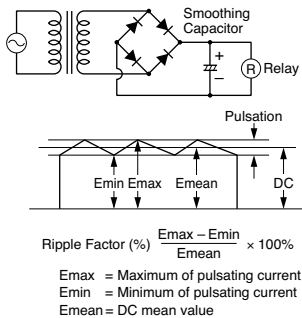

- Operating the relay in sync with an AC load:  
If the relay operates in sync with AC power voltage of the load, the relay life may be reduced. If this is the case, select a relay in consideration of the required reliability for the load. Or, make the relay turn on and off irrespective of the AC power phase or near the point where the AC phase crosses zero voltage.

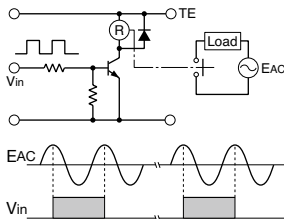

- Leakage current while relay is off:  
When driving an element at the same time as the relay operation, special consideration is needed for the circuit design. As shown in the incorrect circuit below, leakage current ( $I_0$ ) flows through the relay coil while the relay is off. Leakage current causes coil release failure or adversely affects the vibration resistance and shock resistance. Design a circuit as shown in the correct example.

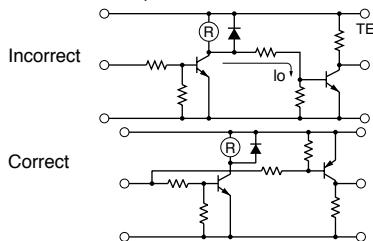

- Surge suppression for transistor driving circuits:  
When the relay coil is turned off, a high-voltage pulse is generated. Be sure to connect a diode to suppress the counter electromotive force. Then, the coil release time becomes slightly longer. To shorten the coil release time, connect a Zener diode between the collector and emitter of the controlling transistor. Select a Zener diode with a Zener voltage slightly higher than the power voltage.

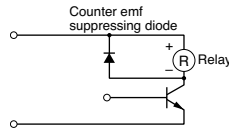

- The coil terminal of the relay has polarity. Connect terminals according to the internal connection diagram. Incorrect wiring may cause malfunction.

### 2. Protection for Relay Contacts

- The contact ratings show maximum values. Make sure that these values are not exceeded. When an inrush current flows through the load, the contact may become welded. If this is the case, connect a contact protection circuit, such as a current limiting resistor.
- Contact protection circuit:  
When switching an inductive load, arcing causes carbides to form on the contacts, resulting in an increased contact resistance. In consideration of contact reliability, contact life, and noise suppression, use of a surge absorbing circuit is recommended. Note that the release time of the load becomes slightly longer. Check the operation using an actual load. Incorrect use of a contact protection circuit will adversely affect switching characteristics. Four typical examples of contact protection circuits are shown in the following table:

RC		This protection circuit can be used when the load impedance is smaller than the RC impedance in an AC load power circuit. R: Resistor of approximately the same resistance value as the load C: 0.1 to 1 $\mu\text{F}$
Diode		This protection circuit can be used for both AC and DC load power circuits. R: Resistor of approximately the same resistance value as the load C: 0.1 to 1 $\mu\text{F}$
Diode		This protection circuit can be used for DC load power circuits. Use a diode with the following ratings. Reverse withstand voltage: Power voltage of the load circuit $\times 10$ Forward current: More than the load current
Varistor		This protection circuit can be used for both AC and DC load power circuits. For a best result, when using on a power voltage of 24 to 48V AC/DC, connect a varistor across the load. When using on a power voltage of 100 to 240V AC/DC, connect a varistor across the contacts.

- Do not use a contact protection circuit as shown below:

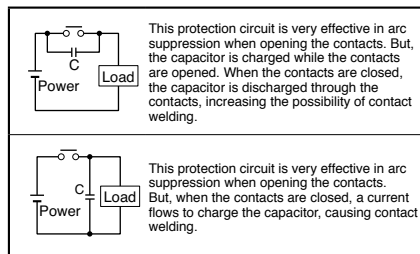

Generally, switching a DC inductive load is more difficult than switching a DC resistive load. Using an appropriate arc suppressor will improve the switching characteristics of a DC inductive load.

### 3. Usage, transport, and storage conditions

- Temperature, humidity, atmospheric pressure during usage, transport, and storage.
  - Temperature:  $-45^{\circ}\text{C}$  to  $+85^{\circ}\text{C}$  (no freezing)  
When the temperature is  $70$  to  $80^{\circ}\text{C}$ , reduce the 6A max. switching current by  $0.1 \text{ A}/^{\circ}\text{C}$
  - Humidity: 5 to 85%RH (no condensation)  
The humidity range varies with temperature. Use within the range indicated in the chart below.
  - Atmospheric pressure: 86 to 106 kPa

### Operating temperature and humidity range

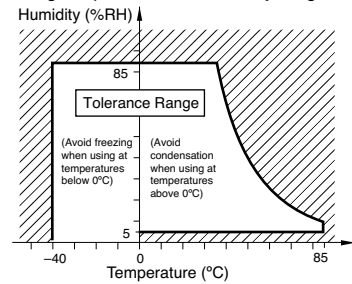

- Condensation  
Condensation occurs when there is a sudden change in temperature under high temperature and high humidity conditions. The relay insulation may deteriorate due to condensation.
- Freezing  
Condensation or other moisture may freeze on the relay when the temperatures is lower than  $0^{\circ}\text{C}$ . This causes problems such as sticking of movable parts or delay in operation.
- Low temperature, low humidity environments  
Plastic parts may become brittle when used in low temperature and low humidity environments.

### 4. Panel Mounting

When mounting DIN rail mount sockets on a panel, take the following into consideration.

- Use M3.5 screws, spring washers, and hex nuts.
- For mounting hole layout, see page 6.
- Keep the tightening torque within 0.49 to 0.68 N·m. Excessive tightening may cause damage to the socket.

### 5. Others

- General notice:
  - To maintain the initial characteristics, do not drop or shock the relay.
  - The relay cover cannot be removed from the base during normal operation. To maintain the initial characteristics, do not remove the relay cover.
  - Use the relay in environments free from condensation, dust, sulfur dioxide ( $\text{SO}_2$ ), and hydrogen sulfide ( $\text{H}_2\text{S}$ ).
  - The RF1V relay cannot be washed as it is not a sealed type. Also make sure that flux does not leak to the PC board and enter the relay.

- Connecting outputs to electronic circuits:  
When the output is connected to a load which responds very quickly, such as an electronic circuit, contact bouncing causes incorrect operation of the load. Take the following measures into consideration.
  - Connect an integration circuit.
  - Suppress the pulse voltage due to bouncing within the noise margin of the load.

- Do not use relays in the vicinity of strong magnetic field, as this may affect relay operation.
- UL and CSA ratings may differ from product rated values determined by IEC.

### 6. Notes on PC Board Mounting

- When mounting 2 or more relays on a PC board, keep a minimum spacing of 10 mm in each direction. If used without spacing of 10 mm, rated current and operating temperature differs. Consult IEC.
- Manual soldering: Solder the terminals at  $400^{\circ}\text{C}$  within 3 sec.
- Auto-soldering: Preliminary heating at  $120^{\circ}\text{C}$  within 120 sec. Solder at  $260^{\circ}\text{C} \pm 5^{\circ}\text{C}$  within 6 sec.
- Because the terminal part is filled with epoxy resin, do not excessively solder or bend the terminal. Otherwise, air tightness will degrade.
- Avoid the soldering iron from touching the relay cover or the epoxy filled terminal part. Use a non-corrosive resin flux.

# RF1V Force Guided Relays/ SF1V Relay Sockets

**Control circuits conforming with safety categories 2, 3, and 4 can be constructed.**

### • Safety category 4 control circuits

The circuit example below consisting of interlock switches, force guided relays, and safety contactors are only a part of a safety-related system in a machine. In actual machines, risk assessment must be performed taking various aspects into consideration such as hazard types, safeguarding measures, and change of hazard level in operating mode, in order to reduce the risk of the entire machine to a tolerable level. The safety category of a machine needs to be evaluated for the entire safety-related system.

### • Safety function at occurrence of single faults

1. If a short-circuit failure occurs at either of the S1 channels, when the safety guard is opened, K2 does not turn off but K1 turns off, so safety function (power interruption to the motor) is maintained. The system does not restart because the NC contact of K2 remains open and K3 is not energized even when S2 is turned on.
2. If a short-circuit failure occurs between S1 channels, the potential difference of K1 and K2 coils become 0V, turning K1 and K2 off. (Fault detection function between safety input circuits)
3. If NO contact of KM1 is welded, KM2 turns off when the safety guard is opened, so the safety function (power interruption to the motor) is maintained. The system does not restart because the NC contact remains open and K3 is not energized even when S2 is turned on.
4. If the NO contact of K1 is welded, K2 turns off when the safety guard is opened, so the safety function (power interruption to the motor) is maintained. The system does not restart because the NC contact of K1 remains open and K3 is not energized even when S2 is turned on.
5. If NC contact of K3 is welded, K1 and K2 turn off when the safety guard is opened, so the safety function (power interruption to the motor) is maintained. Also, the system does not restart because NO contact of K3 does not shut, therefore K1 and K2 cannot be energized.

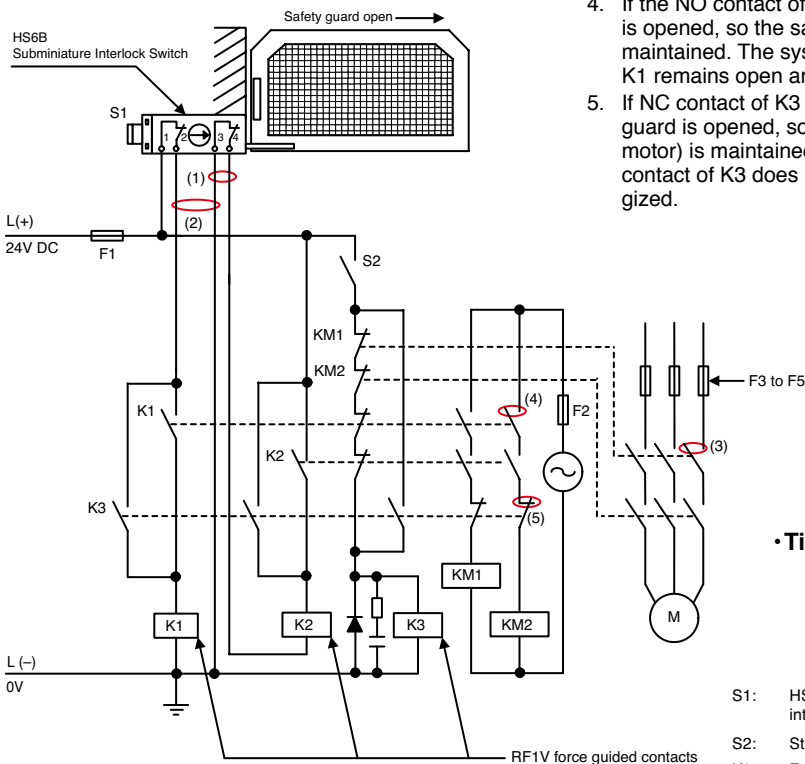

- S1: HS6B subminiature interlock switch
- S2: Start switch (HW series momentary type)
- K1, K2, K3: RF1V force guided relays
- KM1, KM2: Safety contactor
- M: Motor
- F1: Protection fuse for safety circuit
- F2: Protection fuse for mechanical contact output of force guided relay contact
- F3 to F5: Protection fuse for mechanical contact output of safety contactors

### • Time Chart

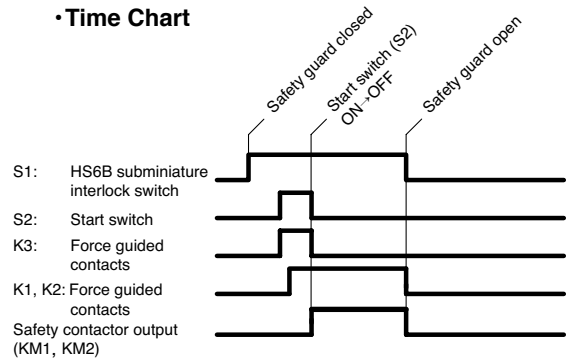

Specifications and other descriptions in this catalog are subject to change without notice.



## IDEC CORPORATION

7-31, Nishi-Miyahara 1-Chome, Yodogawa-ku, Osaka 532-8550, Japan  
Tel: +81-6-6398-2571, Fax: +81-6-6392-9731  
E-mail: marketing@idec.co.jp

**IDEC CORPORATION (USA)**  
1175 Elko Drive, Sunnyvale, CA 94089-2209, USA  
Tel: +1-408-747-0550 / (800) 262-IDEC (4332)  
Fax: +1-408-744-9055 / (800) 635-6246  
E-mail: opencontact@idec.com

**IDEC CANADA LIMITED**  
3155 Pepper Mill Court, Unit 4, Mississauga, Ontario, L5L 4X7, Canada  
Tel: +1-905-890-8561, Toll Free: (888) 317-4332  
Fax: +1-905-890-8562  
E-mail: sales@ca.idec.com

**IDEC AUSTRALIA PTY. LTD.**  
2/3 Macro Court, Rowville, Victoria 3178, Australia  
Tel: +61-3-9763-3244, Toll Free: 1800-68-4332  
Fax: +61-3-9763-3255  
E-mail: sales@au.idec.com

**IDEC ELECTRONICS LIMITED**  
Unit 2, Beechwood, Chineham Business Park, Basingstoke, Hampshire RG24 8WA, UK  
Tel: +44-1256-321000, Fax: +44-1256-327755  
E-mail: sales@uk.idec.com

**IDEC ELEKTROTECHNIK GmbH**  
Wendenstrasse 331, 20537 Hamburg, Germany  
Tel: +49-40-25 30 54 - 0, Fax: +49-40-25 30 54 - 24  
E-mail: service@idec.de

**IDEC (SHANGHAI) CORPORATION**  
Room 608-609, 6F, Gangtai Plaza, No. 700, Yan'an East Road, Shanghai 200001, PRC  
Tel: +86-21-5353-1000, Fax: +86-21-5353-1263  
E-mail: idec@cn.idec.com

**IDEC (BEIJING) CORPORATION**  
Room 211B, Tower B, The Grand Pacific Building, 8A Guanghua Road, Chaoyang District, Beijing 100026, PRC  
Tel: +86-10-6581-6131, Fax: +86-10-6581-5119

**IDEC (SHENZHEN) CORPORATION**  
Unit AB-3B2, Tian Xiang Building, Tian'an Cyber Park, Fu Tian District, Shenzhen, Guangdong 518040, PRC  
Tel: +86-755-8356-2977, Fax: +86-755-8356-2944

**IDEC IZUMI (H.K.) CO., LTD.**  
Units 11-15, Level 27, Tower 1, Millennium City 1, 388 Kwun Tong Road, Kwun Tong, Kowloon, Hong Kong  
Tel: +852-2803-8989, Fax: +852-2565-0171  
E-mail: info@hk.idec.com

**IDEC TAIWAN CORPORATION**  
8F-1, No. 79, Hsin Tai Wu Road, Sec. 1, Hsi-Chih, Taipei County, Taiwan  
Tel: +886-2-2698-3929, Fax: +886-2-2698-3931  
E-mail: service@tw.idec.com

**IDEC IZUMI ASIA PTE. LTD.**  
No. 31, Tannery Lane #05-01, HB Centre 2, Singapore 347788  
Tel: +65-6746-1155, Fax: +65-6844-5995  
E-mail: info@sg.idec.com

www.idec.com

Cat. No. EP1260-0 MARCH 2009 8.2T PRINTED IN JAPAN

(090319)