

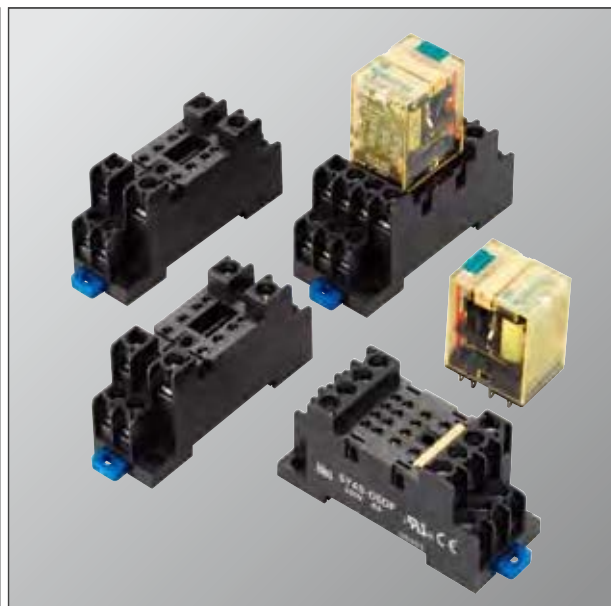

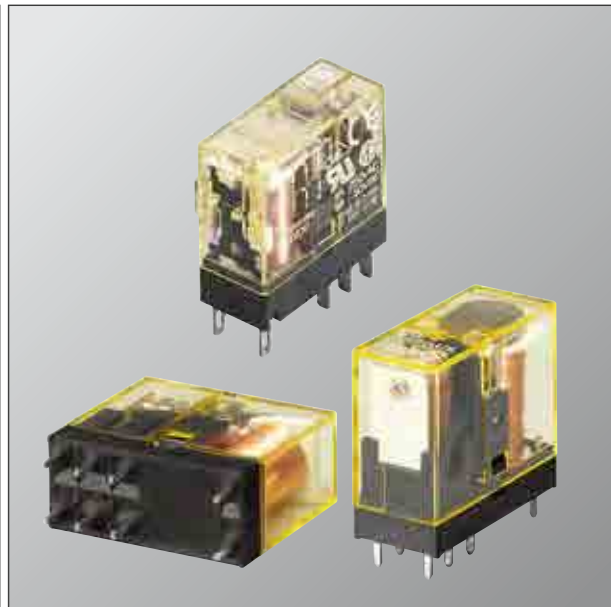



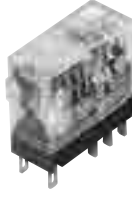
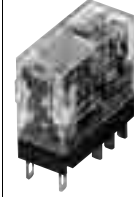

Relays & Sockets

General-purpose electromechanical relays and sockets

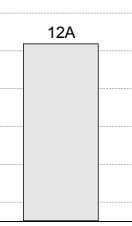

Relays (Selection Guide)

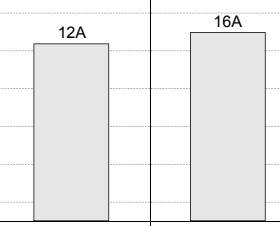
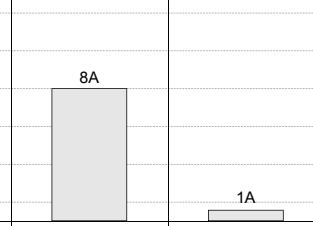











Category		Slim Power Relay						
Model		RJ			RJ PC Board Terminal			
General		• SPDT, DPDT: 12A or 8A contact • RoHS directive compliant		• DPDT	• SPDT, SPST-NO, DPDT, DPST-NO • SPDT and SPST-NO available with 16A rated contacts.			• DPDT, DPST-NO
Shape								
Part No.	Pin Terminal	—	—	—	—	—	—	—
	Blade Terminal	RJ1S	RJ2S	RJ22S	—	—	—	RJ22V
	PC Board Terminal	—	—	—	RJ1V	RJ1V	RJ2V	—
Contact	Contact Configuration	SPDT	DPDT	DPDT (bifurcated)	SPDT, SPST-NO		DPDT, DPST-NO	DPDT (bifurcated) DPST-NO (bifurcated)
	Contact Material	Silver nickel alloy		Silver nickel alloy	Silver nickel alloy	Silver tin indium	Silver nickel alloy	Silver nickel alloy
	Maximum Capacity (A)							
	Rated Load (resistive load)	250V AC, 12A 30V DC, 12A	250V AC, 8A 30V DC, 8A	250V AC, 1A 30V DC, 1A	250V AC, 12A 30V DC, 12A	250V AC, 16A 30V DC, 16A	250V AC, 8A 30V DC, 8A	250V AC, 1A 30V DC, 1A
Coil	Rated Voltage	24, 110, 120, 220, 230, 240V AC 12, 24, 48, 100V DC		12, 24, 110, 115, 120, 220, 230, 240V AC 5, 6, 12, 24, 48, 100-110V DC	12, 24, 110, 115, 120, 220, 230, 240V AC 5, 6, 12, 24, 48, 100V DC			12, 24, 110, 115, 120, 220, 230, 240V AC 5, 6, 12, 24, 48, 100-110V DC
	Power Consumption (approx.)	0.9 VA (60 Hz) 0.53W		1.1 VA (50 Hz), 0.9 to 1.2 VA (50 Hz), 0.53W to 0.64W	0.9 to 1.2 VA (60 Hz) 0.53W to 0.64W			1.1 VA (50 Hz), 0.9 to 1.2 VA (50 Hz), 0.53W to 0.64W
	Pickup Voltage (against rated values)	AC: 80% max., DC: 70% max.		AC: 80% max. DC: 70% max.	AC: 80% max., DC: 70% max.			AC: 80% max. DC: 70% max.
	Dropout Voltage (against rated values)	AC: 30% min., DC: 10% min.		AC: 30% min. DC: 10% min.	AC: 30% min., DC: 10% min.			AC: 30% min. DC: 10% min.
Contact Resistance *1	50 mΩ max.		50 mΩ max.	50 mΩ max.			50 mΩ max.	
Operate Time *2	15 ms max.		15 ms max.	15 ms max.			15 ms max.	
Release Time *2	10 ms max.		10 ms max.	10 ms max.			10 ms max.	
Insulation Resistance	100 MΩ min. (500V DC megger)							
Life	Mechanical	AC: 30,000,000 operations min. DC: 50,000,000 operations min.		AC load: 10 million operations min. DC load: 20 million operations min.	AC: 30,000,000 operations min. (SPDT/DPDT) 10,000,000 operations min. (SPST-NO/DPST-NO) DC: 50,000,000 operations min. (SPDT/DPDT) 20,000,000 operations min. (SPST-NO/DPST-NO)			AC load: 10 million operations min. DC load: 20 million operations min.
	Electrical	AC load: 200,000 operations min. DC load: 100,000 operations min.		AC load: 100,000 operations min. DC load: 200,000 operations min.	AC load: 200,000 operations min. DC load: 100,000 operations min.			AC load: 100,000 operations min. DC load: 200,000 operations min.
Dielectric Strength	Between contact and coil	5000V AC, 1 minute						
	Between same-pole contacts	1000V AC, 1 minute						
Operating Temperature	-40 to +70°C (no freezing)							
Operating Humidity	5 to 85% RH (no condensation)							
Applicable Sockets	DIN rail mount	SJ1S-05B SJ1S-07L	SJ2S-05B SJ2S-07L	SJ2S-05B SJ2S-07L	—	—	—	—
	Panel mount	—	—	—	—	—	—	—
	PC board mount	—	—	SJ2S-61	—	—	—	—
Dimensions (H × W × D mm)	28 × 12.7 × 28.8			27 × 12.7 × 28.8	25.5 × 13 × 29			25.5 × 13 × 29
Weight (approx.)	19g			19g	17g	17g	17g	DPST: 17g, DPST-NO: 16g
Approvals	UL, CSA, VDE, CE			UL, CSA, VDE, CE				
See Page	9			16				

Note: The above table shows initial values.

*1: Measured using 5V DC, 1A voltage drop method





*2: Measured at the rated voltage (25°C)

Relays (Selection Guide)

	Universal Relay			Miniature Relay		
	RU			RY		RM
	• DPDT, 10A contact • Miniature size	• 4PDT, 6A contact • Miniature size	• 4PDT, 3A contact • Bifurcated contact	• DPDT, 4PDT; 3A or 5A contact • 1A bifurcated contact also available		• DPDT, 5A contact • Miniature lightweight relay
						
	—	—	—	—	—	—
	RU2S	RU4S	RU42S	RY2S-U	RY4S-U	RM2S-U
	RU2V	RU4V	RU42V	RY2V-U	RY4V-U	RM2V-U
	DPDT	4PDT	4PDT	DPDT	4PDT	DPDT
	Silver alloy	Gold-clad silver	Gold-clad silver-nickel	Gold-clad silver		Silver
						
	250V AC, 10A 30V DC, 10A	250V AC, 3A 30V DC, 3A	250V AC, 3A 30V DC, 3A	110V AC/30V DC, 3A 220V AC, 3A	240V AC, 5A 30V DC, 5A	110V AC, 5A 220V AC, 5A 30V DC, 5A
	24, 100 (100-110), 110 (110-120), 200 (200-220), 220 (220-240)V AC 6, 12, 24, 48, 110V DC		24, 100 (100-110), 110 (110-120), 200 (200-220), 220 (220-240)V AC 6, 12, 24, 48, 100, 110V DC	DPDT: 6, 12, 24, 50, 100, 110, 115, 120, 200, 220, 230, 240V AC 6, 12, 24, 48, 100, 110V DC 4PDT: 6, 12, 24, 50, 100-110, 110-120, 200-220, 220-240V AC 6, 12, 24, 48, 100-110V DC	6, 12, 24, 50, 100-110, 200-220, 220-240V AC 6, 12, 24, 48, 100-110V DC	
	1.2 VA (60Hz) 1W			1 VA (60Hz) 0.8W	1.2 VA (60Hz) 0.9W	
	AC: 80% max., DC: 80% max.			AC: 80% max., DC: 80% max.		
	AC: 30% min., DC: 10% min.			AC: 30% min., DC: 10% min.		
	50 mΩ max.					30 mΩ max.
	20 ms max.			20 ms min.		
	20 ms max.			20 ms min.		
	100 MΩ min. (500V DC megger)					
	AC: 50,000,000 operations min. DC: 100,000,000 operations min.		50,000,000 operations min.			
	100,000 operations min.	200,000 operations min.	100,000 operations min.	200,000 operations min.	100,000 operations min. 200,000 operations min.	500,000 operations min.
	2500V AC, 1 minute			1500V AC, 1 minute	2000V AC, 1 minute	
	1000V AC, 1 minute					
	Simple: -55 to +70°C, Others: -55 to +60°C (no freezing)			-25 to +55°C (no freezing)		
	5 to 85% RH (no condensation)			45 to 85% RH (no condensation)		
	SU2S-11L, SM2S-05A, SM2S-05C, SM2S-05D, SM2S-05DF	SU4S-11L, SY4S-05A, SY4S-05C, SY4S-05D, SY4S-05DF	SY2S-05A SY2S-05C	SY4S-05A SY4S-05DF SY4S-05C SY4S-05D	SM2S-05A SM2S-05DF SM2S-05C SM2S-05D	
	SM2S-51	SY4S-51	SY2S-51	SY4S-51	SM2S-51	
	SM2S-61	SY4S-61	SY2S-61	SY4S-61 SY4S-62	SM2S-61 SM2S-62	
	35 × 21 × 27.5			35.6 × 14 × 27.5	35.6 × 21 × 27.5	
	35g			23g	34g	
	UL, c-UL, TÜV, CE			UL, CSA, TÜV, CE		
	23			33		38

Note: The above table shows initial values.
*1: Measured using 5V DC, 1A voltage drop method
*2: Measured at the rated voltage (25°C)

Relays (Selection Guide)

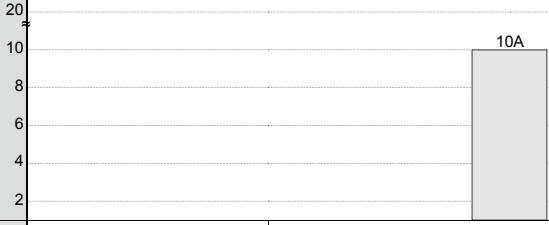







Category		Power Relay			
Model		RH			
General		<ul style="list-style-type: none"> • SPDT, DPDT, 3PDT, 4PDT; 10A contact • Miniature size 			
Shape					
Part No.	Pin Terminal	—	—	—	—
	Blade Terminal	RH1B-U	RH2B-U	RH3B-U	RH4B-U
	PC Board Terminal	RH1V2-U	RH2V2-U	RH3V2-U	RH4V2-U
Contact Configuration		SPDT	DPDT	3PDT	4PDT
Contact Material		Silver cadmium oxide			
Contact	Maximum Capacity (A)				
	Rated Load (resistive load)	110V AC/30V DC, 10A 220V AC, 7A	110V AC/30V DC, 10A 220V AC, 7.5A		
Coil	Rated Voltage	6, 12, 24, 50, 100, 110, 115, 120, 200, 220, 230, 240V AC 6, 12, 24, 48, 100, 110V DC	6, 12, 24, 50, 100-110, 110-120, 200-220, 220-240V AC 6, 12, 24, 48, 100-110V DC	6, 12, 24, 50, 100, 110, 115, 120, 200, 220, 230, 240V AC 6, 12, 24, 48, 100, 110V DC	
	Power Consumption (approx.)	1 VA (60Hz) 0.8W	1.2 VA (60Hz) 0.9W	1.7 VA (60Hz) 1.5W	2 VA (60Hz) 1.5W
	Pickup Voltage (against rated values)	AC: 80% max., DC: 80% max.			
	Dropout Voltage (against rated values)	AC: 30% min., DC: 10% min.			
Contact Resistance *1		50 mΩ max.			
Operate Time *2		20 ms max.		25 ms max.	
Release Time *2		20 ms max.		25 ms max.	
Insulation Resistance		100 MΩ min. (500V DC megger)			
Life	Mechanical	50,000,000 operations min.			
	Electrical	200,000 operations min.	500,000 operations min.	200,000 operations min.	
Dielectric Strength	Between contact and coil	2000V AC, 1 minute			
	Between same-pole contacts	1000V AC, 1 minute			
Operating Temperature		-25 to +50°C (no freezing)	-25 to +40°C (no freezing)		
Operating Humidity		45 to 85% RH (no condensation)			
Applicable Sockets	DIN rail mount	SH1B-05A SH1B-05C	SH2B-05A SH2B-05C SH2B-05D	SH3B-05A SH3B-05C	SH4B-05A SH4B-05C
	Panel mount	SH1B-51	SH2B-51	SH3B-51	SH4B-51
	PC board mount	SH1B-62	SH2B-62	SH3B-62	SH4B-62
Dimensions (H × W × D mm)		35.6 × 14 × 27.5	35.6 × 21 × 27.5	35.6 × 31 × 27.5	35.6 × 41 × 27.5
Weight (approx.)		24g	37g	50g	74g
Approvals		UL, CSA, TÜV, CE			
See Page		41			

Note: The above table shows initial values.

*1: Measured using 5V DC, 1A voltage drop method

*2: Measured at the rated voltage (25°C)

Relays (Selection Guide)



	Power Relay			Latch Relay	
	RR			RR2KP	RY2KS
	• SPDT, 10A contact • Heavy duty power relay	• DPDT, 3PDT; 10A contact • Heavy duty power relay		• DPDT; 10A contact • Dual coil latch relay	• DPDT; 3A contact • Dual coil latch relay
					
	—	RR2P-U	RR3P-U RR3PA-U	RR2KP-U	—
	RR1BA-U	RR2BA-U	RR3B-U	—	RY2KS-U
	—	—	—	—	—
	SPDT	DPDT	3PDT	DPDT	DPDT
	Silver	Silver		Silver	Gold-plated silver
					
	110V AC, 10A 220V AC, 7.5A 30V DC, 10A	110V AC, 10A 220V AC, 7.5A 30V DC, 10A		110V AC/10A, 220V AC/7.5A, 30V DC/10A, 100V DC/0.5A	110/220V AC, 3A 30V DC, 3A 100V DC, 0.2A
	6, 12, 24, 50, 100, 110, 115, 120, 200, 220, 230, 240V AC 6, 12, 24, 48, 110V DC	6, 12, 24, 50, 100, 110, 115, 120, 200, 220, 230, 240V AC 6, 12, 24, 48, 110V DC		6, 12, 24, 50, 100, 110, 115, 120, 200, 220, 230, 240V AC 6, 12, 24, 48, 110V DC	6, 12, 24, 50, 100, 120V AC 6, 12, 24, 48, 100, 110V DC
	2.5 VA (60Hz) 1.5W	2.5 VA (60Hz) 1.5W		2.2 VA (60Hz) 1.5W	1.5 VA (60Hz) 1.2W
	AC: 80% max., DC: 80% max.	AC: 80% max., DC: 80% max.		Set voltage: 80% max.	Set voltage: 80% max.
	AC: 30% min., DC: 15% min.	AC: 30% min., DC: 15% min.		Reset voltage: 80% max.	Reset voltage: 80% max.
	30 mΩ max.	30 mΩ max.		30 mΩ max.	50 mΩ max.
	25 ms max.	25 ms max.		Set time: 20 ms max.	Set time: 25 ms max.
	25 ms max.	25 ms max.		Reset time: 20 ms max.	Reset time: 25 ms max.
	100 MΩ min. (500V DC megger)	100 MΩ min. (500V DC megger)			
	10,000,000 operations min.	10,000,000 operations min.		50,000,000 operations min.	
	200,000 operations min.	200,000 operations min.		500,000 operations min.	200,000 operations min.
	2000V AC, 1 minute	Pin terminal: 1500V AC, 1 minute Blade terminal: 2000V AC, 1 minute		1500V AC, 1 minute	1500V AC, 1 minute
	1000V AC, 1 minute	1000V AC, 1 minute		1000V AC, 1 minute	700V AC, 1 minute
	-25 to +40°C (no freezing)	-25 to +40°C (no freezing)		-5 to +40°C (no freezing)	
	5 to 85% RH (no condensation)	5 to 85% RH (no condensation)		45 to 85% RH (no condensation)	
	SR3B-05	SR2P-05A, SR2P-06A, SR2P-05C SR3B-05	SR3P-05A, SR3P-06A, SR3P-05C	SR3P-05A, SR3P-05C, SR3P-06A	SY4S-05A SY4S-05C
	SR3B-51	SR2P-511, SR2P-70 SR3B-51	SR3P-511, SR3P-70 SR3B-51	SR3P-511 SR3P-70	SY4S-51
	—	—	—	—	SY4S-61 SY4S-62
	47.5 × 36 × 36	55.5 × 29 × 36	55.5 × 36 × 36	80.5 × 36 × 36	55.3 × 21 × 27.5
	82g	90g (pin terminal)	96g (pin terminal)	170g	67g
	UL, CSA	UL, CSA, TÜV, CE		UL, CSA	UL, CSA
	48			59	61

Note: The above table shows initial values.

*1: Measured using 5V DC, 1A voltage drop method

*2: Measured at the rated voltage (25°C)

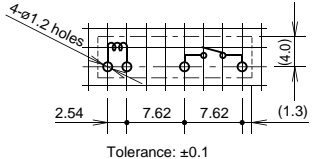

Relays (Selection Guide)

Category		PC Board Relay	
Model		RV3T	
General		1NO contact, 5A 5mm-wide, 12.5mm-high space-saving card relay.	
Shape			
Part No.		RV3T-1G	RV3T-2G
Contact	Contact Configuration	SPST-NO (twin)	
	Contact Material	Silver alloy (gold clad)	
	Maximum Capacity (A)		
	Rated Load (resistive load)	250V AC 5A, 24V DC 5A	
Coil	Rated Voltage	5, 12, 24V DC	
	Power Consumption (approx.)	120mW	200mW
	Pickup Voltage (against rated values)	70% maximum	
	Dropout Voltage (against rated values)	10% minimum	
Contact Resistance *1	30mΩ maximum		
Operate Time *2	10ms maximum		
Release Time *2	5ms maximum		
Insulation Resistance		100MΩ minimum (500V DC meggar)	
Life	Mechanical	20,000,000 operations minimum	
	Electrical	See page 53.	
Dielectric Strength	Between contact and coil	2000V AC, 1 minute	
	Between same-pole contacts	750V AC, 1 minute	
Protection Structure		Washable	
Operating Temperature		40 to +70°C (no freezing)	
Operating Humidity		45 85% RH (no condensation)	
Storage Temperature		40 +70°C (no freezing)	
Storage Humidity		45 85% RH (no condensation)	
Dimensions (H × W × D mm)		12.6 × 5.08 × 21.3	
Weight (approx.)		3g	
Approvals		UL, CSAs TÜV, CE	
Terminal Arrangement (bottom view)		<p>All dimensions in mm.</p>  <p>Tolerance: ±0.1</p>	
Page		52	

Note: The above table shows initial values.

*1: Measured using 5V DC, 1A voltage drop method

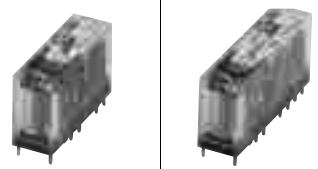
*2: Measured at the rated voltage

Category		Force Guided Relay	
Model		RF1V	
General		4-pole, 6A 6-pole, 6A Force guided contact mechanism	
Shape			
Part No.		RF1V(4-pole)	RF1V(6-pole)
Contact	Contact Configuration	2NO-2NC, 3NO-1NC	4NO-2NC, 5NO-1NC, 3NO-3NC
	Contact Material	AgSnO ₂ (Au flashed)	
	Maximum Capacity (A)		
	Rated Load (resistive load)	250V AC, 6A, 30V DC, 6A	
Coil	Rated Voltage	12, 24, 48V DC	
	Power Consumption (approx.)	0.36W	0.5W
	Pickup Voltage (against rated values)	DC: 75% maximum	
	Dropout Voltage (against rated values)	DC: 10% maximum	
Contact Resistance *1	100mΩ maximum		
Operate Time *2	20ms maximum		
Release Time *2	20ms maximum		
Insulation Resistance		1000MΩ (DC500V meggar, same measurement positions as the dielectric strength)	
Life	Mechanical	10,000,000 operations minimum	
	Electrical	100,000 operations minimum (250V AC 6A, 30V DC 6A) 500,000 (250V AC 1A, 30V DC 1A)	
Dielectric Strength	Between contact and coil	4000V AC, 1 minute	
	Between different-pole contacts	2500V AC, 1 minute Between contacts 7-8 and 9-10	2500V AC, 1 minute Between contacts 7-8 and 11-12 Between contacts 9-10 and 13-14 Between contacts 11-12 and 13-14
	Between same-pole contacts	4000V AC, 1 minute Between contacts 3-4 and 5-6, Between contacts 3-4 and 7-8, Between contacts 5-6 and 9-10	4000V AC, 1 minute Between contacts 3-4 and 5-6 Between contacts 3-4 and 7-8 Between contacts 5-6 and 9-10 Between contacts 7-8 and 9-10
Operating Temperature		-40 to +85°C (no freezing)	
Operating Humidity		5 to 85% RH (no condensation)	
Storage Temperature		-40 to +85°C (no condensation)	
Storage Humidity		5 to 85% RH (no condensation)	
Applicable Socket	Din Rail	SF1V-4-07L	SF1V-6-07L
	PC Board	SF1V-4-61	SF1V-6-61
Dimensions (H × W × D mm)		24 × 13 × 40	24 × 13 × 50
Weight (approx.)		20g	23g
Approvals		UL, c-UL, TÜV	
Page		54	

Note: The above table shows initial values.

*1: Measured using 5V DC, 1A voltage drop method

*2: Measured at the rated voltage (25°C)

Operating Instructions

Driving Circuit for Relays

- To make sure of correct relay operation, apply rated voltage to the relay coil.
- Input voltage for the DC coil:
A complete DC voltage is best for the coil power to make sure of stable relay operation. When using a power supply containing a ripple voltage, suppress the ripple factor within 5%. When power is supplied through a rectification circuit, the relay operating characteristics, such as pickup voltage and dropout voltage, depend on the ripple factor. Connect a smoothing capacitor for better operating characteristics as shown below.

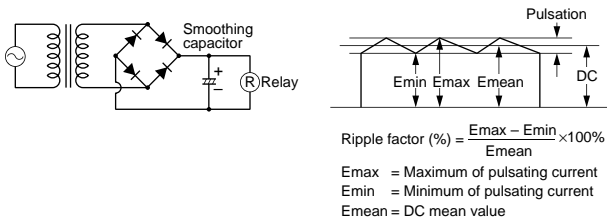

- Operating the relay in synchronism with AC load:
If the relay operates in synchronism with the AC power voltage of the load, the relay life may be reduced. If this is the case, select a relay in consideration of the required reliability for the load. Or, make the relay turn on and off irrespective of the AC power phase or near the point where the AC phase crosses zero voltage.

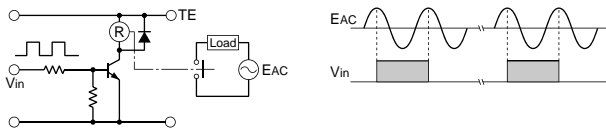

- Leakage current while relay is off:
When driving an element at the same time as the relay operation, a special consideration is needed for the circuit design. As shown in the incorrect circuit below, Leakage current (I_o) flows through the relay coil while the relay is off. Leakage current causes the coil release failure or adversely affects the vibration resistance and shock resistance. Design a circuit as shown in the correct example.

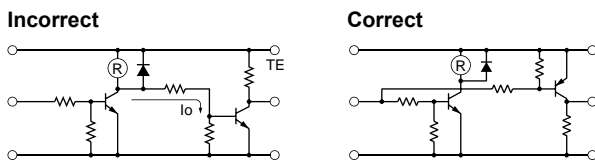

- Surge suppression for transistor driving circuits:
When the relay coil is turned off, a high-voltage pulse is generated, causing the transistor to deteriorate and sometimes to break. Be sure to connect a diode to suppress the counter electromotive force. Then, the coil release time becomes slightly longer. To shorten the coil release time, connect a Zener diode between the collector and emitter of the transistor. Select a Zener diode with a Zener voltage slightly higher than the power voltage.

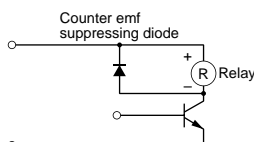

Protection for Relay Contacts

- The contact ratings show maximum values. Make sure that these values are not exceeded. When an inrush current flows through the load, the contact may become welded. If this is the case, connect a contact protection circuit, such as a current limiting resistor.
- Contact protection circuit:
When switching an inductive load, arcing causes carbides to form on the contacts, resulting in an increased contact resistance. In consideration of contact reliability, contact life, and noise suppression, use of a surge absorbing circuit is recommended. Note that the release time of the load becomes slightly longer. Check the operation using the actual load. Incorrect use of a contact protection circuit will adversely affect switching characteristics. Four typical examples of contact protection circuits are shown in the following table:

RC		This protection circuit can be used when the load impedance is smaller than the RC impedance in an AC load power circuit. R: Resistor of approximately the same resistance value as the load C: 0.1 to 1 μF
		This protection circuit can be used for both AC and DC load power circuits. R: Resistor of approximately the same resistance value as the load C: 0.1 to 1 μF
Diode		This protection circuit can be used for DC load power circuits. Use a diode with the following ratings: Reverse withstand voltage: Power voltage of the load circuit \times 10 Forward current: More than the load current
Varistor		This protection circuit can be used for both AC and DC load power circuits. For a best result, when using on a power voltage of 24 to 48V AC/DC, connect a varistor across the load. When using on a power voltage of 100 to 240V AC/DC, connect a varistor across the contacts.

- Do not use a contact protection circuit as shown below:

	This protection circuit is very effective in arc suppression when opening the contacts. But, the capacitor is charged while the contacts are opened. When the contacts are closed, the capacitor is discharged through the contacts, increasing the possibility of contact welding.
	This protection circuit is very effective in arc suppression when opening the contacts. But, when the contacts are closed, a current flows to charge the capacitor, causing contact welding.

Generally, switching a DC inductive load is more difficult than switching a DC resistive load. Using an appropriate arc suppressor, however, will improve the switching characteristics of a DC inductive load.

Notes on PC Board Mounting

- When mounting two or more relays on a PC board collectively, take other components into consideration. Do not use relays in the vicinity of strong magnetic field as this may affect relay operation.
- Do not install the relay on the PC board in the way the PC board is bent, otherwise copper foil may be cut or solder may be displaced after operating for a long time or due to vibration, degrading the relay's performance.

Operating Instructions

Operating Instructions

3. Relay direction must be taken into consideration when installing the relay on PC board so that shock noise resistance, life, contact reliability is maintained.

- Shock Resistance

To maintain shock resistance, it is ideal to mount the relay so that the armature movement is perpendicular to the direction of vibration and shock.

- Life

Large load that causes arcs may result in the contact material scattered off, accumulating around the contact. This will degrade insulation resistance between the circuits. Make sure that relay is mounted in the correct direction.

- Contact Reliability

It is not desirable for a single relay to switch both large and low level load. The scattered contact material produced when switching the large load adheres to the contacts when switching the low level load and may cause contact failure. Therefore, when multipole relay, avoid install the relay in the direction where the low level contacts comes below the large load. Also avoid terminal connection.

4. Mounting Space

When two or more mounting relays closely, observe the instructions below.

- Ambient Temperature

When two or more relays are mounted, provide sufficient spacing between the relays (see the minimum spacing) so that the interaction of relays do not generate excessive heat.

- When multiple PC boards with relays are mounted to a rack, the temperature may rise excessively. When mounting relays, leave enough space so that heat will not build up, and so that the Relays' ambient temperature remains within the specified operating temperature range.

5. RV3T

- Auto-soldering does not cause flux to enter inside the relay. Also, auto-cleaning will not cause the cleaning liquid to enter inside the relay.

- Use alcohol-based solvents for cleaning.

- Cleaning with the boiling method is recommended. Avoid ultrasonic cleaning on relays. Use of ultrasonic cleaning may cause breaks in the coil or slight sticking of the contacts due to the ultrasonic energy.

Soldering

1. When soldering the relay terminals, use a soldering iron of 60W (350°C), and quickly complete soldering within approximately 3 seconds. Sn-Ag-Cu is recommended for lead-free soldering.

2. Auto-soldering: Solder at 250°C within 4 to 5 seconds.

3. Because the terminal part is filled with epoxy resin, do not excessively solder or bend the terminal. Otherwise, air tightness will degrade;

4. Avoid the soldering iron from touching the relay cover or the epoxy filled terminal part.

5. Use a non-corrosive rosin flux.

Other Precautions

1. General notice:

- To maintain the initial characteristics, do not drop the relay or shock the relay.

- The relay cover cannot be removed from the base during normal operation. To maintain the initial characteristics, do not remove the relay cover.

- Use the relay in environments free from condensation of dust, sulfur dioxide (SO₂), and hydrogen sulfide (H₂S).

- Make sure that the coil voltage does not exceed the applicable coil voltage range.

2. Connecting outputs to electronic circuits:

When the output is connected to a load which responds very quickly, such as an electronic circuit, contact bouncing causes incorrect operation of the load. Take the following measures into consideration.

- Connect an integral circuit.

- Suppress the pulse voltage due to bouncing within the noise margin of the load.

3. UL- and CSA-approved ratings may differ from product rated values determined by IDEC.

4. Do not use relays in the vicinity of strong magnetic field as this may affect relay operation.

- DC diode type has polarity.

- The surge absorbing element on AC relays with RC or DC relays with diode is provided to absorb the counter electromotive force generated by the coil. When the relay is subject to an excessive external surge voltage, the surge absorbing element may be damaged. Add another surge absorbing provision to the relay to prevent damage.

Safety Precautions

- Turn off the power to the relay before starting installation, removal, wiring, maintenance, and inspection of the relays. Failure to turn power off may cause electrical shock or fire hazard.

- Observe specifications and rated values, otherwise electrical shock or fire hazard may be caused.

- Use wires of the proper size to meet the voltage and current requirements. Tighten the terminal screws on the relay socket to the proper tightening torque.

RJ series Slim Power Relays

Compact and rugged power relays. Large switching capacity.

- Compact housing only 12.7-mm wide.
Large contact rating
RJ1S (1-pole): 12A
RJ2S (2-pole): 8A
- Non-polarized LED indicator available. IDEC's unique light guide structure enables high visibility of coil status from any direction.
- Excellent electrical and mechanical life.
Electrical life: 200,000 operations (AC load)
Mechanical life: 30 million operations (AC coil)
- Environmentally friendly, RoHS directive compliant (EU directive 2002/95/EC). Contains no lead, cadmium, mercury, hexavalent chromium, PBB or PBDE).
- Diode type
Diode reverse withstand voltage: 1000V
- UL recognized, CSA certified, EN compliant.
- Lloyd Register type approved.

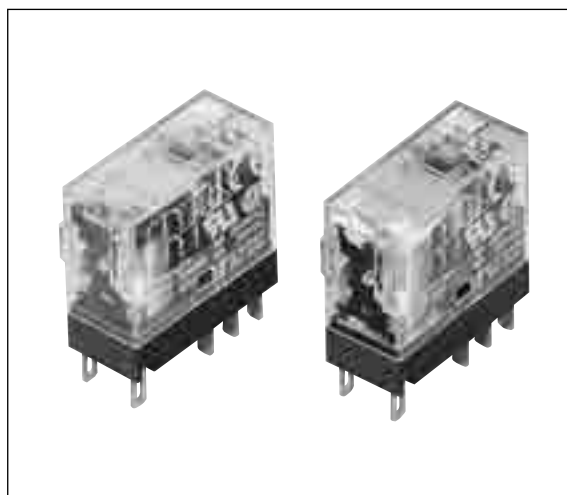

Applicable Standards	Mark	Certification Organization / File No.
UL508		UL recognized, File No. E55996
CSA C22.2 No. 14		CSA File No. LR35144
EN61810-1		VDE No. 40015055
		EU Low Voltage Directive

Plug-in Terminal

Style	1-pole (SPDT)		2-pole (DPDT)	
	Part No.	Code	Part No.	Code
Standard (with LED Indicator)	RJ1S-CL-*	A12 D5 A24 D6 A110 D12	RJ2S-CL-*	A12 D5 A24 D6 A110 D12
Simple (without LED Indicator)		A120 D24 A220 D48 A230 D100 A240		RJ2S-C-*
With diode (DC coil only) (with LED indicator) A1: -, A2: +	RJ1S-CLD-*	D12 D24	RJ2S-CLD-*	D12 D24
With diode (DC coil only) A1: -, A2: +				
With diode (DC coil only) (with LED indicator) A1: +, A2: -	RJ1S-CLD1-*	D48 D100	RJ2S-CLD1-*	D48 D100
With diode (DC coil only) A1: +, A2: -				
With RC (with LED indicator)	RJ1S-CLR-*	A12 A24	RJ2S-CLR-*	A12 A24
With RC (without LED indicator)		RJ1S-CR-*		A110 A220

Note: Coil voltages other than shown above are available (ex. A115, A230, A240)

Coil Voltage Code *

Code	Rated Coil Voltage
A12	12V AC
A24	24V AC
A110	110V AC
A120	120V AC
A220	220V AC
A230	230V AC
A240	240V AC
D5	5V DC
D6	6V DC
D12	12V DC
D24	24V DC
D48	48V DC
D100	100-110V DC

Note: Specify a coil voltage code in place of * in the Part No.

Contact Ratings

No. of Poles	Contact	Allowable Contact Power		Rated Load			Allowable Switching Current	Allowable Switching Voltage	Minimum Applicable Load (Note)			
		Resistive Load	Inductive Load	Voltage	Resistive Load	Inductive Load cos ϕ = 0.3 L/R = 7 ms						
1	NO	3000VA AC 360W DC	1875VA AC 180W DC	250V AC 30V DC	12A 12A	7.5A 6A	12A	250V AC 125V DC	5V DC, 100 mA (reference value)			
		NC	3000VA AC 180W DC	1875VA AC 90W DC	250V AC 30V DC	12A 6A				7.5A 3A		
	NO		2000VA AC 240W DC	1000VA AC 120W DC	250V AC 30V DC	8A 8A				4A 4A	8A	250V AC 125V DC
		NC	2000VA AC 120W DC	1000VA AC 60W DC	250V AC 30V DC	8A 4A				4A 2A		

Note: Measured at operating frequency of 120 operations per minute.
Failure rate level P, 1/10,000,000 (reference value) (JIS C5003)

RJ Series Slim Power Relays

Approved Ratings

Voltage	UL				CSA								VDE			
	Resistive				Resistive				Inductive				Resistive		AC-15, DC-13 (Note)	
	RJ1		RJ2		RJ1		RJ2		RJ1		RJ2		RJ1	RJ2	RJ1	RJ2
	NO	NC	NO	NC	NO	NC	NO	NC	NO	NC	NO	NC	NO	NO	NO	NO
250V AC	12A	12A	8A	8A	12A	12A	8A	8A	7.5A	7.5A	4A	4A	12A	8A	6A	3A
30V DC	12A	6A	8A	4A	12A	6A	8A	4A	6A	3A	4A	2A	12A	8A	2.5A	2A

Note: According to the utilization categories of IEC60947-5-1

Coil Ratings

Rated Voltage	Coil Voltage Code	Without LED Indicator		With LED Indicator			Operating Characteristics (against rated values at 20°C)			Power Consumption			
		Rated Current (mA) ±15% (at 20°C)		Coil Resistance (Ω) ±10% (at 20°C)		Rated Current (mA) ±15% (at 20°C)		Coil Resistance (Ω) ±10% (at 20°C)			Minimum Pickup Voltage	Dropout Voltage	Maximum Continuous Applied Voltage (Note)
		50 Hz	60 Hz	50 Hz	60 Hz	50 Hz	60 Hz	50 Hz	60 Hz				
AC 50/60 Hz	12V AC	A12	87.3	75.0	62.5	91.1	78.8	62.5	80% maximum	30% minimum	140%	Approx. 0.9 VA (60Hz)	
	24V AC	A24	43.9	37.5	243	47.5	41.1	243					
	110V AC	A110	9.6	8.2	5270	9.5	8.1	5270					
	120V AC	A120	8.8	7.5	6400	8.7	7.4	6400					
	220V AC	A220	4.8	4.1	21530	4.8	4.1	21530					
	240V AC	A240	4.6	3.9	24100	4.6	3.9	24100					
DC	5V	D5	106		47.2	110		47.2	70% maximum	10% minimum	170%	Approx. 0.53W	
	6V	D6	88.3		67.9	92.2		67.9					
	12V	D12	44.2		271	48.0		271					
	24V	D24	22.1		1080	25.7		1080					
	48V	D48	11.0		4340	10.7		4340					
	100-110V	D100	5.3-5.8		18870	5.2-5.7		18870					

Note: Maximum continuous applied voltage is the maximum voltage that can be applied on relay coils.

Specifications

Model		RJ1S	RJ2S
Number of Poles		1-pole	2-pole
Contact Configuration		SPDT	DPDT
Contact Material		Silver-nickel alloy	
Degree of Protection		IP40	
Contact Resistance (initial value) (*1)		50 mΩ maximum	
Operate Time (*2)		15 ms maximum	
Release Time (*2)		10 ms maximum (with diode: 20 ms maximum)	
Dielectric Strength	Between contact and coil	5000V AC, 1 minute	5000V AC, 1 minute
	Between contacts of the same pole	1000V AC, 1 minute	1000V AC, 1 minute
	Between contacts of different poles	—	3000V AC, 1 minute
Vibration Resistance	Operating extremes	10 to 55 Hz, amplitude 0.75 mm	
	Damage limits	10 to 55 Hz, amplitude 0.75 mm	
Shock Resistance	Operating extremes	NO contact: 200 m/s ² , NC contact: 100 m/s ²	
	Damage limits	1000 m/s ²	
Electrical Life (rated load)		AC load: 200,000 operations minimum (operation frequency 1800 operations per hour) DC load: 100,000 operations minimum (operation frequency 1800 operations per hour)	
Mechanical Life (no load)		AC coil: 30,000,000 operations minimum (operation frequency 18,000 operations per hour) DC coil: 50,000,000 operations minimum (operation frequency 18,000 operations per hour)	
Operating Temperature (*3)		-40 to +70°C (no freezing)	
Operating Humidity		5 to 85% RH (no condensation)	
Weight (approx.)		19g	

Note: Above values are initial values.

*1: Measured using 5V DC, 1A voltage drop method.

*2: Measured at the rated voltage (at 20°C), excluding contact bounce time.

*3: 100% rated voltage.

Applicable Socket

Terminal	Part No.		Page
	RJ1S (1-pole)	RJ2S (2-pole)	
Standard Screw Terminal	SJ1S-05B	SJ2S-05B	64
Finger-safe Screw Terminal	SJ1S-07L	SJ2S-07L	

RJ Series Slim Power Relays

Dimensions

RJ1S

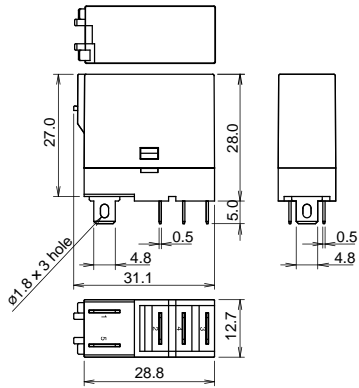

RJ2S-CL

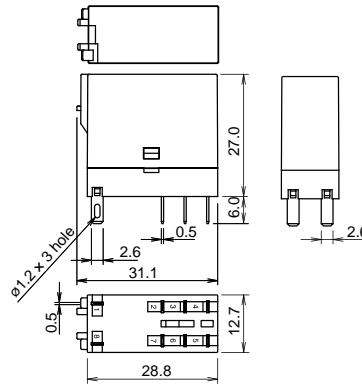

All dimensions in mm.

Internal Connection Diagrams

RJ1S-CL-* Standard (w/LED Indicator)

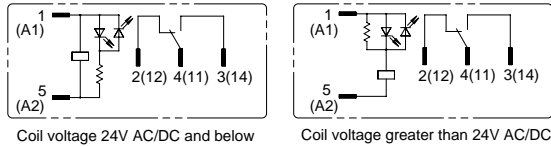

RJ2S-CL-* Standard (w/LED Indicator)

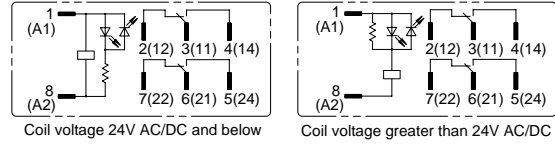

RJ1S-C-* Simple

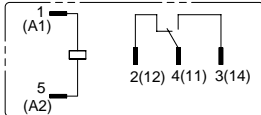

RJ2S-C-* Simple

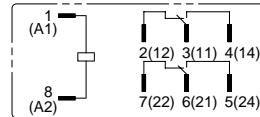

RJ1S-CLD-* With Diode (w/LED Indicator)

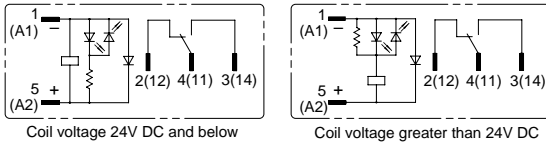

RJ2S-CLD-* With Diode (w/LED Indicator)

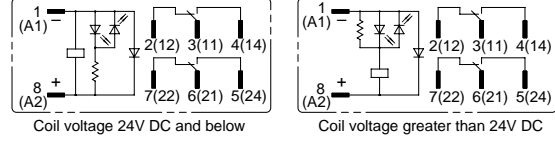

RJ1S-CD-* With Diode

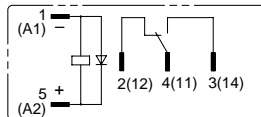

RJ2S-CD-* With Diode

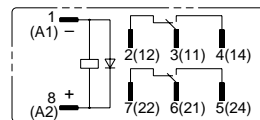

RJ1S-CLD1-* With Diode (w/LED Indicator)

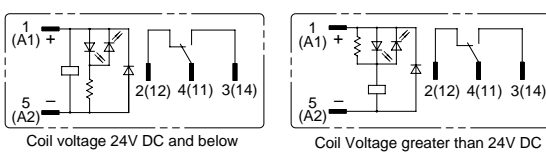

RJ2S-CLD1-* With Diode (w/LED Indicator)

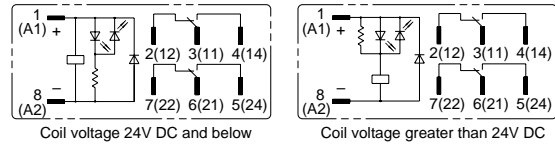

RJ1S-CD1-* With Diode

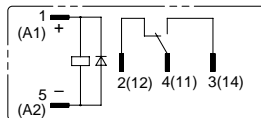

RJ2S-CD1-* With Diode

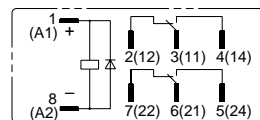

RJ1S-CLR-* With RC (w/LED Indicator)

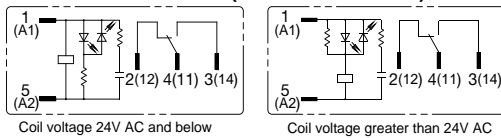

RJ2S-CLR-* With RC (w/LED Indicator)

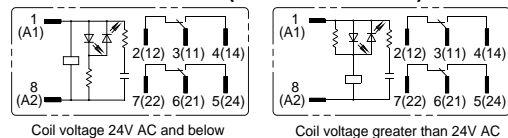

RJ1S-CR-* With RC

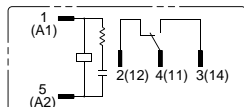

RJ2S-CR-* With RC

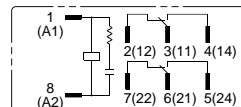

RJ Series Slim Power Relays

Electrical Life Curve

RJ1 (resistive load)

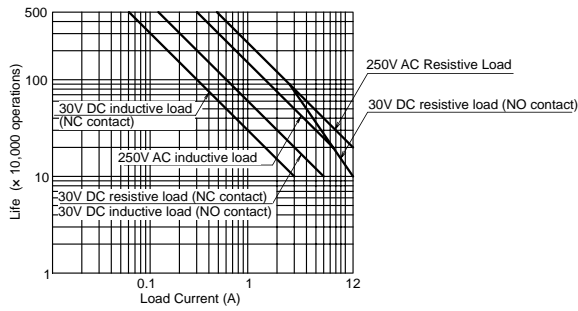

RJ2 (resistive load)

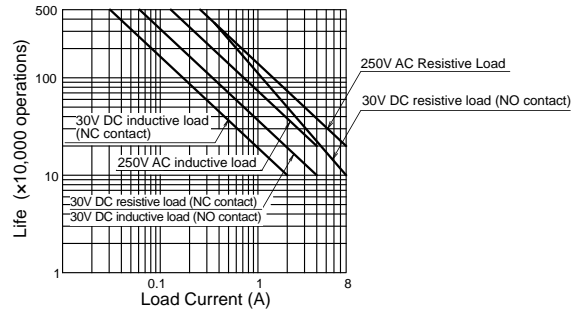

Maximum Switching Capacity

RJ1 (resistive load)

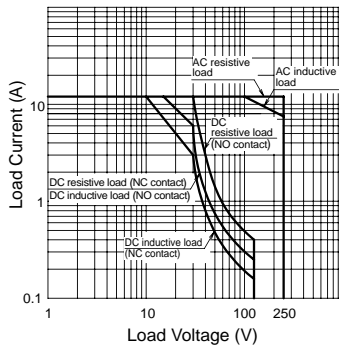

RJ2 (resistive load)

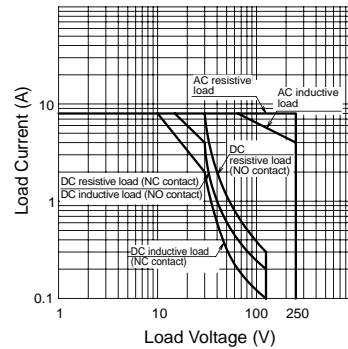

Operating Temperature and Coil Temperature Rise

RJ1

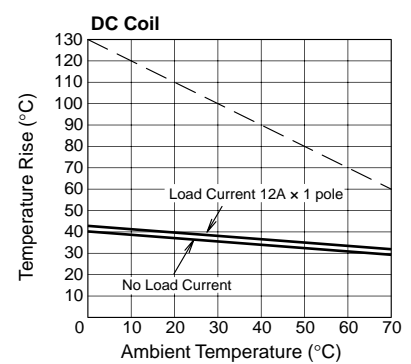
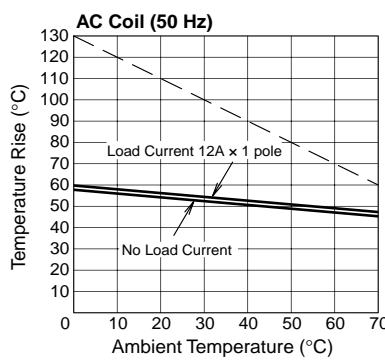
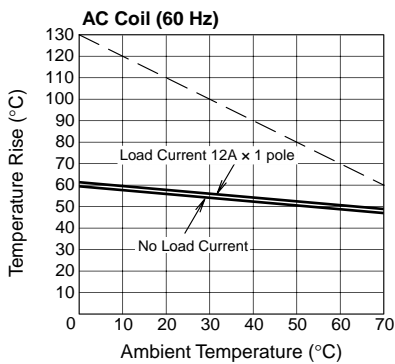

RJ2

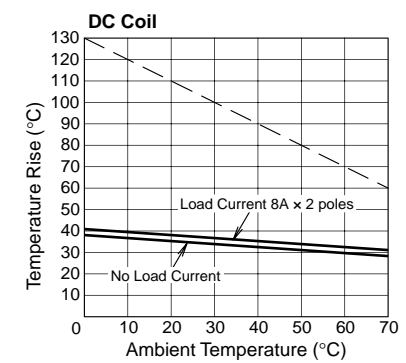
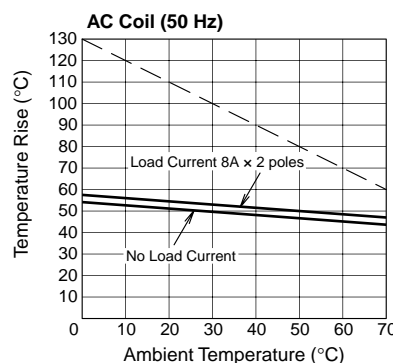
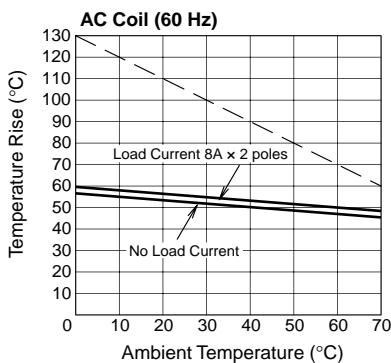





The above temperature rise curves show characteristics when 100% the rated coil voltage is applied. The slanted dashed line indicates allowable temperature rise for the coil at different ambient temperatures.

RJ Series Slim Power Relay Plug-in Terminal (bifurcated contacts)

High contact reliability with bifurcated contacts (minimum applicable load: 1V DC, 100 μ A)

- The smallest width for 2-pole/bifurcated contacts relay (based on IDEC research as of April 2011)
- Non-polarized green LED indicator available (except for simple type)
- IDEC's unique light-guide structure enables an RJ relay to be identified by the illuminating LED.
- Diode, reverse polarity diode, and RC circuits are available.
- Peak inverse voltage is 1000V.
- UL recognized, CSA certified, VDE approved, EN compliant.

Applicable Standards

Applicable Standards	Mark	File No. or Organization
UL508		UL Recognized File No. E55996
CSA C22.2 No.14		CSA File No. LR35144
EN61810-1		VDE No. 40015055
		EU Low Voltage Directive

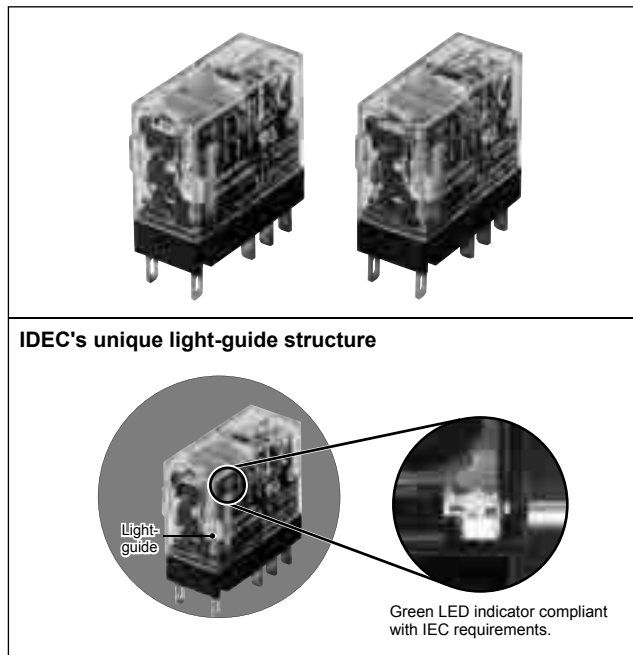

Relays

Bifurcated Contacts

Style	2-pole (bifurcated contacts DPDT)		
	Part No.	Coil Voltage Code	
Standard (with LED indicator)	RJ22S-CL-*	A12, A24, A110, A115, A120, A220, A230, A240, D5, D6, D12, D24, D48, D100	
Simple (without LED indicator)			
With diode (with LED indicator)	RJ22S-CLD-*	D5, D6, D12, D24, D48, D100	
With diode (without LED indicator)			
With diode Reverse polarity (with LED indicator)	RJ22S-CLD1-*		
With diode Reverse polarity (without LED indicator)			
With RC circuit (with LED indicator)	RJ22S-CLR-*		A12, A24, A110, A115, A120, A220, A230, A240
With RC circuit (without LED indicator)			

Coil Voltage Code

Code	Voltage
A12	12V AC
A24	24V AC
A110	110V AC
A115	115V AC
A120	120V AC
A220	220V AC
A230	230V AC
A240	240V AC
D5	5V DC
D6	6V DC
D12	12V DC
D24	24V DC
D48	48V DC
D100	100-110V DC

Contact Ratings

Allowable Contact Power		Rated Load			Allowable Switching Current	Allowable Switching Voltage	Minimum Applicable Load (Note)
Resistive Load	Inductive Load	Voltage	Resistive Load	Inductive Load $\cos\phi=0.4$ L/R=7ms			
250VA AC 30W DC	100VA AC 15W DC	250V AC	1A	0.4A	1A	250V AC 125V DC	1V DC 100 μ A (reference value)
		30V DC	1A	0.5A			

Note: Measured at operating frequency of 120 operations per minute.
Failure rate level P, 1/10,000,000 (reference value) (JIS C5003)

RJ Series Slim Power Relay Plug-in Terminal (bifurcated contacts)

Ratings

Voltage	UL Ratings				CSA Ratings						VDE Ratings	
	Resistive		General Use		Resistive		Inductive		General Use		Resistive	
	NO	NC	NO	NC	NO	NC	NO	NC	NO	NC	NO	NC
250V AC	—	—	1A	1A	—	—	—	—	1A	1A	1A	1A
30V DC	1A	1A	—	—	1A	1A	1A	1A	—	—	1A	1A

Coil Ratings

Rated Voltage (V)	Coil Voltage Code	Without LED Indicator				With LED Indicator			Operating Characteristics (against rated values at 20°C)			Power Consumption
		Rated Current (mA) ±15% (at 20°C)		Coil Resistance (Ω) ±10% (at 20°C)	Rated Current (mA) ±15% (at 20°C)		Coil Resistance (Ω) ±10% (at 20°C)	Pickup Voltage (initial value)	Dropout Voltage (initial value)	Maximum Continuous Applied Voltage (Note)		
		50Hz	60Hz		50Hz	60Hz						
AC 50/60 Hz	12V	A12	87.3	75.0	62.5	91.1	78.8	62.5	80% maximum	30% minimum	140%	Approx. 1.1VA (50Hz) 0.9 to 1.2VA (60Hz)
	24V	A24	43.9	37.5	243	47.5	41.1	243				
	110V	A110	9.6	8.2	5,270	9.5	8.1	5,270				
	115V	A115	9.1	7.8	6,030	9.0	7.7	6,030				
	120V	A120	8.8	7.5	6,400	8.7	7.4	6,400				
	220V	A220	4.8	4.1	21,530	4.8	4.1	21,530				
	230V	A230	4.6	3.9	24,100	4.6	3.9	24,100				
240V	A240	4.3	3.7	25,570	4.3	3.7	25,570					
DC	5V	D5	106		47.2		110		70% maximum	10% minimum	170%	Approx. 0.53 to 0.64W
	6V	D6	88.3		67.9		92.2					
	12V	D12	44.2		271		48.0					
	24V	D24	22.1		1,080		25.7					
	48V	D48	11.0		4,340		10.7					
	100-110V	D100	5.3-5.8		18,870		5.2-5.7					

Note: Maximum continuous applied voltage is the maximum voltage that can be applied to relay coils.

Specifications

Model		RJ22S
Number of Poles		2-pole
Contact Configuration		DPDT (bifurcated contacts)
Contact Material		AgNi (gold clad)
Degree of Protection		IP40
Contact Resistance (initial value)		50 mΩ maximum (measured using 5V DC, 1A voltage drop method)
Operating Time (at 20°C)		15 ms maximum (at the rated coil voltage, excluding contact bounce time) With diode or RC: 20 ms maximum
Release Time (at 20°C)		10 ms maximum (at the rated coil voltage, excluding contact bounce time) With diode or RC: 20 ms maximum
Impulse Withstand Voltage		10,000V AC (between contact and coil)
Insulation Resistance		100 MΩ minimum (500V DC megger)
Dielectric Strength	Between contact and coil	5,000V AC, 1 minute
	Between contacts of the same pole	1,000V AC, 1 minute
	Between contacts of the different poles	3,000V AC, 1 minute
Vibration Resistance	Operating Extremes	10 to 55 Hz, amplitude 0.75 mm
	Damage Limits	10 to 55 Hz, amplitude 0.75 mm
Shock Resistance	Operating Extremes	NO contact: 200 m/s ² , NC contact: 100 m/s ²
	Damage Limits	1,000 m/s ²
Electrical Life		AC load: 100,000 operations minimum (operating frequency 1,800 per hour) DC load: 200,000 operations minimum (operating frequency 1,800 per hour)
Mechanical Life		AC load: 10 million operations minimum (operating frequency 18,000 operations per hour) DC load: 20 million operations minimum (operating frequency 18,000 operations per hour)
Operating Temperature (100% rated voltage)		-40 to +70°C (no freezing)
Operating Humidity		5 to 85% RH (no condensation)
Storage Temperature		-40 to +85°C (no freezing)
Storage Humidity		5 to 85% RH (no condensation)
Weight (approx.)		19g

Applicable Sockets

Style	Part No.	Ordering No.	Package Quantity
Standard Screw Terminal	SJ2S-05B	SJ2S-05B	1
Finger-safe Screw Terminal	SJ2S-07L	SJ2S-07L	1
PC Board Terminal	SJ2S-61	SJ2S-61PN10	10
	SJ2S-61	SJ2S-61PN50	50

RJ Series Slim Power Relay Plug-in Terminal (bifurcated contacts)

Dimensions

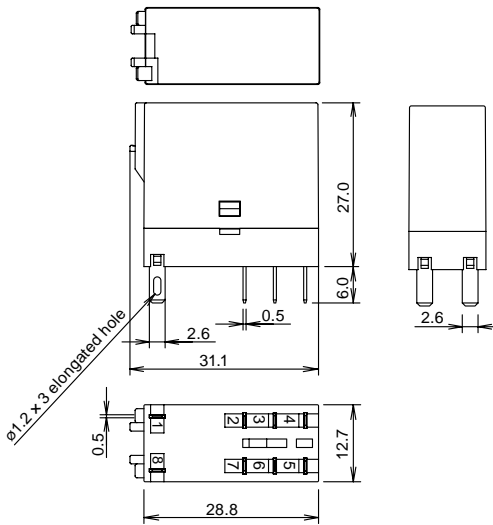

All dimensions in mm.

Internal Connection (bottom view)

RJ22S-CL-* Standard (with LED indicator)

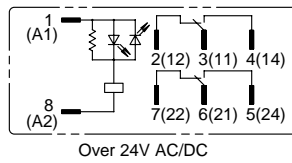
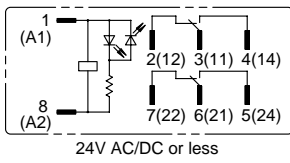

RJ22S-CLD1-* With diode/reverse polarity (with LED indicator)

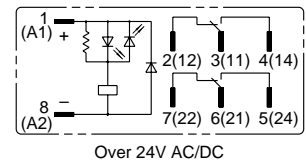
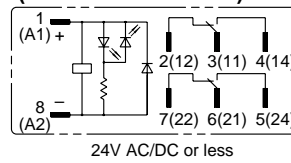

RJ22S-C-* Simple

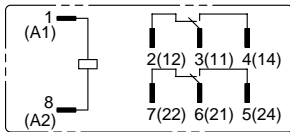

RJ22S-CD1-* With diode/reverse polarity

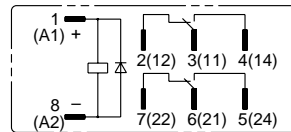

RJ22S-CLD-* With diode (with LED indicator)

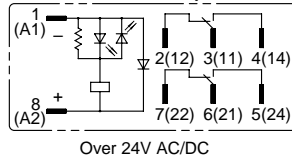
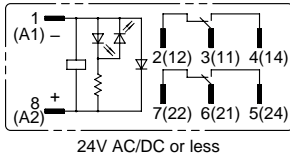

RJ22S-CLR-* With RC (with LED indicator)

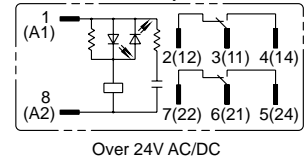
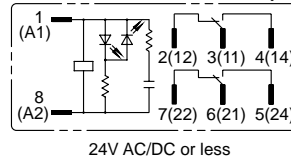

RJ22S-CD-* With diode

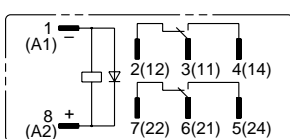

RJ22S-CR-* With RC

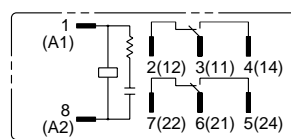

Operating Temperature and Coil Temperature Rise

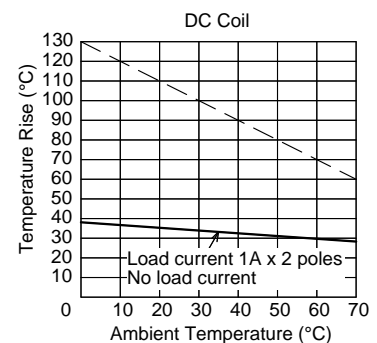
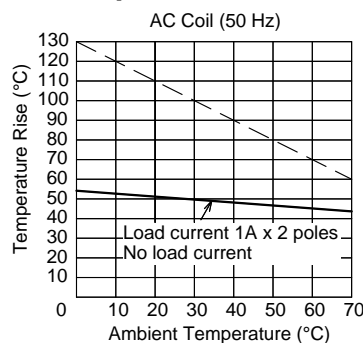
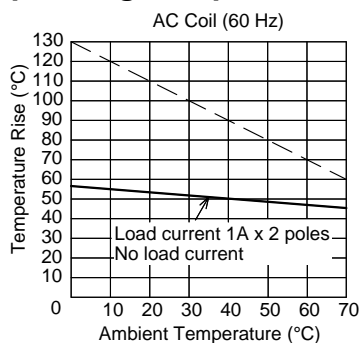

- The slanted dashed line indicates the allowable temperature rise for the coil at different ambient temperatures.
- The above temperature rise curves show the characteristics when 100% of the rated coil voltage is applied.

RJ Series Slim Power Relays PC Board Terminal

Compact power relays. High switching capacity up to 16A.

- Contact configurations:
SPDT, SPST-NO, DPDT, DPST-NO.
SPDT, SPST-NO are available in high capacity type.
- Compact housing—only 12.7-mm wide.
- High contact rating
RJ1V (1-pole): 12A, 16A
RJ2V (2-pole): 8A
- IDEC's unique spring return mechanism ensures long electrical and mechanical life.
Electrical life: 200,000 operations (AC load)
Mechanical life: 30 million operations (AC coil, SPDT, DPDT)
- Flux-tight structure
- Environmentally friendly, RoHS directive compliant (EU directive 2002/95/EC). Contains no lead, cadmium, mercury, hexavalent chromium, PBB, or PBDE).



Standard	Mark	Certification Organization / File No.
UL508		UL recognized File No. E55996
CSA C22.2 No. 14		CSA File No. LR35144
EN61810-1		VDE No. 40015055
		EU Low Voltage Directive

PC Board Terminal

No. of Poles	Style	Contact	Part No.	Coil Voltage Code	Package Quantity
1	Plain	SPDT	RJ1V-C*	Specify a coil voltage code in place of * in the Part No. A12 D5 A24 D6 A110 D12 A115 D24 A120 D48 A220 D100 A230 A240	1
		SPST-NO	RJ1V-A*		
	High Capacity	SPDT	RJ1V-CH*		
		SPST-NO	RJ1V-AH*		
2	Plain	DPDT	RJ2V-C*		
		DPST-NO	RJ2V-A*		

Coil Voltage Code *

Code	Rated Coil Voltage
A12	12V AC
A24	24V AC
A110	110V AC
A115	115V AC
A120	120V AC
A220	220V AC
A230	230V AC
A240	240V AC
D5	5V DC
D6	6V DC
D12	12V DC
D24	24V DC
D48	48V DC
D100	100-110V DC

Note: Specify a coil voltage code in place of * in the Part No.

Contact Ratings

No. of Poles	Style	Contact	Allowable Contact Power		Rated Load			Allowable Switching Current	Allowable Switching Voltage	Minimum Applicable Load (reference value)
			Resistive Load	Inductive Load	Voltage	Resistive Load	Inductive Load cos ϕ = 0.3 L/R = 7 ms			
1	Plain	NO	3000VA AC 360W DC	1875VA AC 180W DC	250V AC 30V DC	12A 12A	7.5A 6A	12A	250V AC 125V DC	5V DC, 100 mA
		NC	3000VA AC 180W DC	1875VA AC 90W DC	250V AC 30V DC	12A 6A	7.5A 3A			
	High Capacity	NO	4000VA AC 480W DC	2000VA AC 240W DC	250V AC 30V DC	16A 16A	8A 8A	16A	250V AC 125V DC	
		NC	4000VA AC 240W DC	2000VA AC 120W DC	250V AC 30V DC	16A 8A	8A 4A			
2	Plain	NO	2000VA AC 240W DC	1000VA AC 120W DC	250V AC 30V DC	8A 8A	4A 4A	8A	250V AC 125V DC	5V DC, 10 mA
					250V AC 30V DC	8A 4A	4A 2A			
		NC	2000VA AC 120W DC	1000VA AC 60W DC	250V AC 30V DC	8A 4A	4A 2A			
					250V AC 30V DC	8A 4A	4A 2A			

RJ series Slim Power Relays PC Board Terminal

Standard Ratings

UL ratings

Voltage	Resistive					
	RJ1 (plain)		RJ2 (plain)		RJ1 (high capacity)	
	NO	NC	NO	NC	NO	NC
AC250V	12A	6A	8A	4A	16A	8A
30V DC	12A	6A	8A	4A	16A	8A

VDE ratings

Voltage	Resistive			AC-15, DC-13 (Note)	
	RJ1 (plain)	RJ2 (plain)	RJ1 (high capacity)	RJ1 (plain)	RJ2 (plain)
	NO	NO	NO	NO	NO
AC250V	12A	8A	16A	6A	3A
30V DC	12A	8A	16A	2.5A	2A

Note: The operational current represents the classification by making and breaking currents (IEC 60947-5-1.)

CSA ratings

Voltage	Resistive						Inductive					
	RJ1 (plain)		RJ2 (plain)		RJ1 (high capacity)		RJ1 (plain)		RJ2 (plain)		RJ1 (high capacity)	
	NO	NC	NO	NC	NO	NC	NO	NC	NO	NC	NO	NC
AC250V	12A	12A	8A	8A	16A	16A	7.5A	7.5A	4A	4A	8A	8A
30V DC	12A	6A	8A	4A	16A	8A	6A	3A	4A	2A	8A	4A

Coil Ratings

Rated Voltage	Coil Voltage Code	Rated Current (mA) ±15% (at 20°C)		Coil Resistance (Ω) ±10% (at 20°C)	Operating Characteristics (against rated values at 20°C)			Power Consumption	
		50 Hz	60 Hz		Minimum Pickup Voltage (initial value)	Dropout Voltage (initial value)	Maximum Continuous Applied Voltage (Note)		
AC 50/60 Hz	12V	A12	87.3	75.0	80% maximum	30% minimum	140%	Approx. 1.1 VA (50Hz) Approx. 0.9 to 1.2VA (60Hz)	
	24V	A24	43.9	37.5					243
	110V	A110	9.6	8.2					5270
	115V	A115	9.1	7.8					6030
	120V	A120	8.8	7.5					6400
	220V	A220	4.8	4.1					21530
	230V	A230	4.6	3.9					24100
240V	A240	4.3	3.7	25570					
DC	5V	D5	106		70% maximum	10% minimum	170%	Approx. 0.53W to 0.64W	
	6V	D6	88.3						67.9
	12V	D12	44.2						271
	24V	D24	22.1						1080
	48V	D48	11.0						4340
	100-110V	D100	5.3-5.8						18870

Note: Maximum continuous applied voltage is the maximum voltage that can be applied to relay coils.

Specifications

Model	RJ1V Plain	RJ1V High Capacity	RJ2V Plain
Number of Poles	1-pole	1-pole	2-pole
Contact Configuration	SPDT, SPST-NO	SPDT, SPST-NO	DPDT, DPST-NO
Contact Material	Ag-Ni	Ag-Sn-In	Ag-Ni
Enclosure Ratings	Flux-tight		
Contact Resistance (initial value) (*1)	50 mΩ maximum		
Operate Time (*2)	15 ms maximum		
Release Time (*2)	10 ms maximum		
Impulse Withstand Voltage	10,000V (between contact and coil)		
Dielectric Strength	Between contact and coil	5000V AC, 1 minute	5000V AC, 1 minute
	Between contacts of the same pole	1000V AC, 1 minute	1000V AC, 1 minute
	Between contacts of different poles	—	
Vibration Resistance	Operating extremes	10 to 55 Hz, amplitude 0.75 mm	
	Damage limits	10 to 55 Hz, amplitude 0.75 mm	
Shock Resistance	Operating extremes	NO contact: 200 m/s ² (20G), NC contact: 100 m/s ² (10G)	
	Damage limits	1000 m/s ² (100G)	
Mechanical Life (no load)	AC coil: 30 million operations minimum (SPDT/DPDT, operation frequency 18,000 operations per hour) 10 million operations minimum (SPST-NO/DPST-NO, operation frequency 18,000 operations/h) DC coil: 50 million operations minimum (SPDT/DPDT, operation frequency 18,000 operations per hour) 20 million operations minimum (SPST-NO/DPST-NO, operation frequency 18,000 operations/h)		
Electrical Life (rated load)	AC load: 200,000 operations minimum (operation frequency 1,800 operations per hour) DC load: 100,000 operations minimum (operation frequency 1,800 operations per hour)		
Operating Temperature (*3)	-40 to +70°C (no freezing)		
Operating Humidity	5 to 85% RH (no condensation)		
Weight (approx.)	SPDT: 17g SPST-NO: 16g	SPDT: 17g SPST-NO: 16g	DPDT: 17g DPST-NO: 16g

*1: Measured using 5V DC, 1A voltage drop method.

*2: Measured at the rated voltage (at 20°C), excluding contact bounce time.

*3: 100% rated voltage.

RJ Series Slim Power Relays PC Board Terminal

Electrical Life Curve

RJ1V Plain

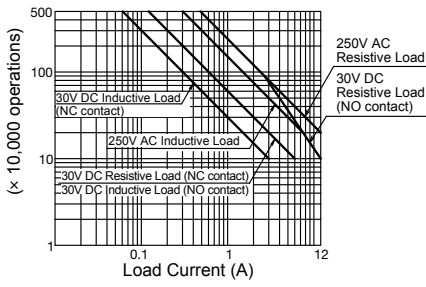

RJ1V High Capacity

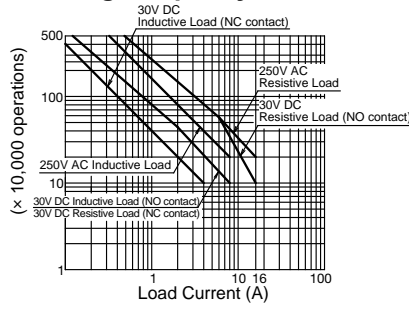

RJ2V Plain

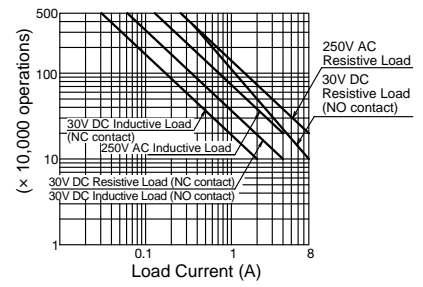

Maximum Switching Current

RJ1V Plain

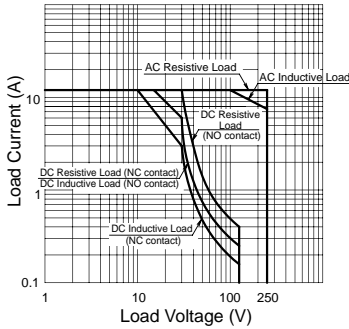

RJ1V High Capacity

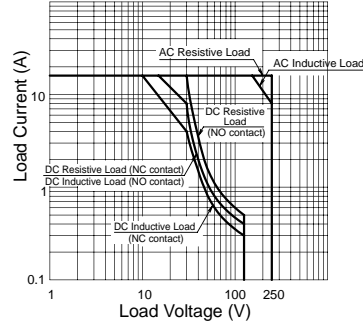

RJ2V Plain

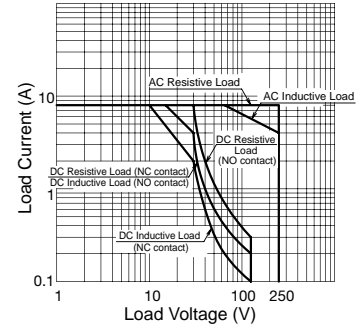

Ambient Temperature vs. Temperature Rise Curves

RJ1V Plain

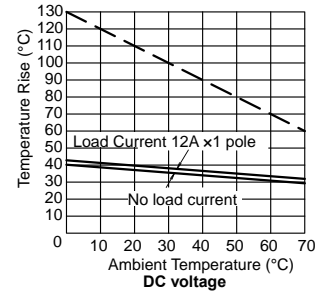
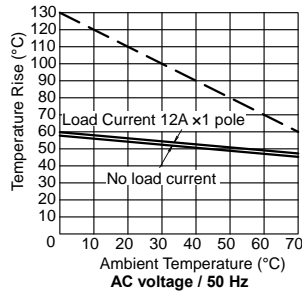
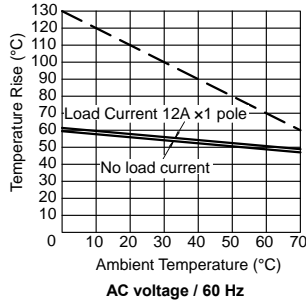

RJ2V Plain

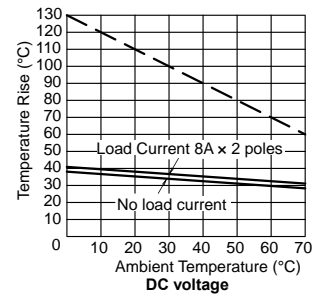
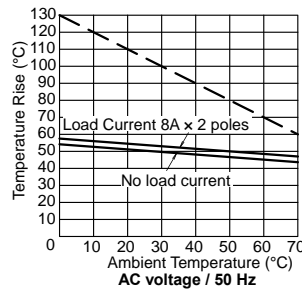
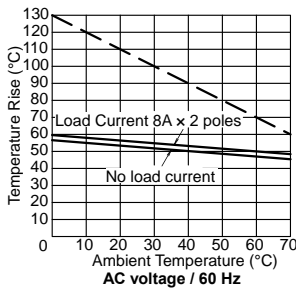

The above temperature rise curves show the characteristics when 100% of the rated coil voltage is applied. The slant dashed line indicates the allowable temperature rise for the coil at different ambient temperatures.

RJ Series Slim Power Relays PC Board Terminal

Dimensions

RJ1V-C-* Plain SPDT



Mounting Hole Layout (Bottom View)

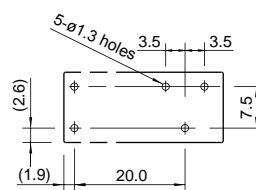

Internal Circuit Diagram (Bottom View)

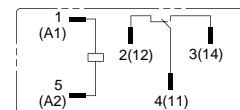

RJ1V-A-* Plain SPST-NO

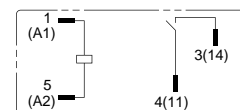
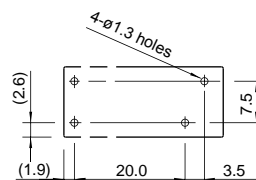
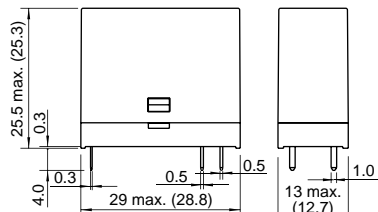

RJ1V-CH-* High Capacity SPDT

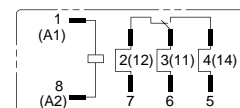
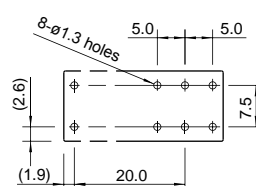

RJ1V-AH-* High Capacity SPST-NO

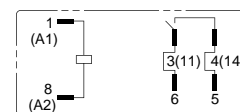
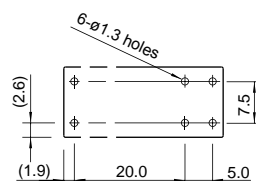
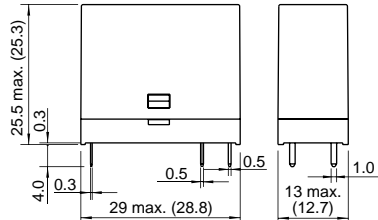

RJ2V-C-* Plain DPDT

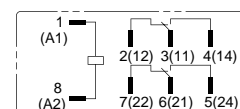
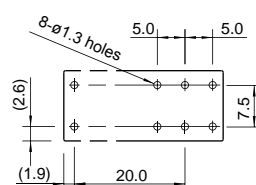
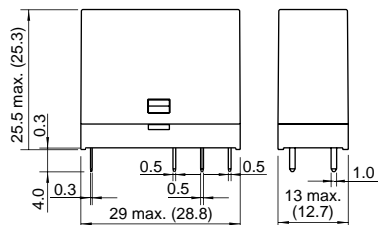

RJ2V-A-* Plain DPST-NO

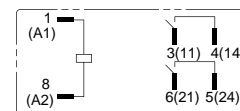
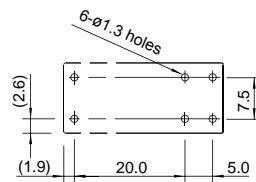
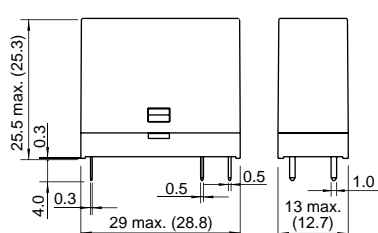

All dimensions in mm.

Instructions

Notes on PC Board Mounting





- When using two or more RJ relays on a PC board, maintain at least 5mm distance between the relays.
- Manual soldering: Use a soldering iron of 60W (350°C), and quickly complete soldering with approximately 3 seconds. Sn-Ag-Cu is recommended when using lead-free solder.
- Auto-soldering: Solder at 250°C within 4 to 5 seconds.
- Because the terminal part is filled with epoxy resin, do not excessively solder or bend the terminal. Otherwise, air tightness will degrade.
- Avoid the soldering iron from touching the relay cover or the epoxy filled terminal part.
- Use a non-corrosive resin flux.

RJ Series Slim Power Relays PC Board Terminal (bifurcated contacts)

High contact reliability with bifurcated contacts (minimum applicable load: 1V DC, 100 μ A)

- DPDT, DPST-NO contacts are available.
- The smallest width for 2-pole/bifurcated contacts relay (based on IDEC research as of April 2011)
- IDEC's unique spring return mechanism ensures long life.
- Flux-tight structure

Applicable Standards

Applicable Standards	Mark	File No. or Organization
UL508		UL Recognized File No. E55996
CSA C22.2 No.14		CSA File No. LR35144
EN61810-1		VDE No. 40015055
		EU Low Voltage Directive

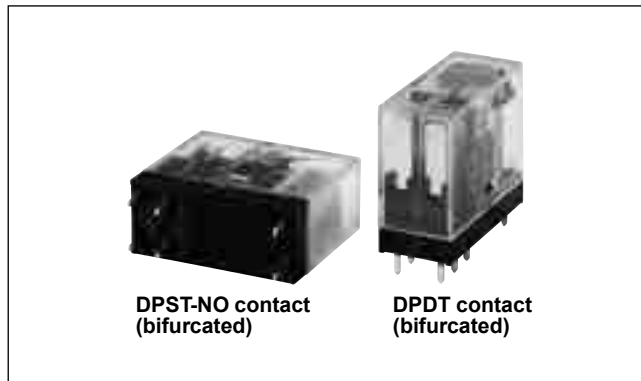

Relays

Bifurcated Contacts

Style	Contact	2-pole (bifurcated contacts DPDT)	
		Part No.	Coil Voltage Code
Plain	DPDT	RJ22V-C-*	A12, A24, A110, A115, A120, A220, A230, A240, D5, D6, D12, D24, D48, D100
	DPST-NO	RJ22V-A-*	

Coil Voltage Code

Code	Voltage
A12	12V AC
A24	24V AC
A110	110V AC
A115	115VAC
A120	120V AC
A220	220V AC
A230	230V AC
A240	240V AC
D5	5V DC
D6	6V DC
D12	12V DC
D24	24V DC
D48	48V DC
D100	100-110V DC

Contact Ratings

Allowable Contact Power		Rated Load			Allowable Switching Current	Allowable Switching Voltage	Minimum Applicable Load (Note)
Resistive Load	Inductive Load	Voltage	Resistive Load	Inductive Load $\cos\phi=0.4$ L/R=7ms			
250VA AC 30W DC	100VA AC 15W DC	250V AC	1A	0.4A	1A	250V AC 125V DC	1V DC 100 μ A (reference value)
		30V DC	1A	0.5A			

Note: Measured at operating frequency of 120 operations per minute (failure rate level P, reference value)

Ratings

Voltage	UL ratings				CSA Ratings						VDE Ratings	
	Resistive		General Use		Resistive		Inductive		General Use		Resistive	
	NO	NC	NO	NC	NO	NC	NO	NC	NO	NC	NO	NC
250V AC	—	—	1A	1A	—	—	—	—	1A	1A	1A	1A
30V DC	1A	1A	—	—	1A	1A	1A	1A	—	—	1A	1A

RJ series Slim Power Relays PC Board Terminal (bifurcated contacts)

Coil Ratings

Rated Voltage (V)	Coil Voltage Code	Rated Current (mA) $\pm 15\%$ (at 20°C)		Coil Resistance (Ω) $\pm 10\%$ (at 20°C)	Operating Characteristics (against rated values at 20°C)			Power Consumption	
		50Hz	60Hz		Pickup Voltage (initial value)	Dropout Voltage (initial value)	Maximum Continuous Applied Voltage (Note)		
AC 50/60 Hz	12V	A12	87.3	75.0	62.5	80% maximum	30% minimum	140%	Approx. 1.1VA (50Hz) 0.9 to 1.2VA (60Hz)
	24V	A24	43.9	37.5	243				
	110V	A110	9.6	8.2	5,270				
	115V	A115	9.1	7.8	6,030				
	120V	A120	8.8	7.5	6,400				
	220V	A220	4.8	4.1	21,530				
	230V	A230	4.6	3.9	24,100				
	240V	A240	4.3	3.7	25,570				
DC	5V	D5	106		47.2	70% maximum	10% minimum	170%	Approx. 0.53 to 0.64W
	6V	D6	88.3		67.9				
	12V	D12	44.2		271				
	24V	D24	22.1		1,080				
	48V	D48	11.0		4,340				
	100-110V	D100	5.3-5.8		18,870			160%	

Note: Maximum continuous applied voltage is the maximum voltage that can be applied to relay coils.

Specifications

Model	RJ22V	
Number of Poles	2-pole	
Contact Configuration	DPDT (bifurcated), DPST-NO (bifurcated)	
Contact Material	AgNi (gold clad)	
Degree of Protection	Flux-tight structure	
Contact Resistance (initial value)	50 m Ω maximum (measured using 5V DC, 1A voltage drop method)	
Operating Time (at 20°C)	15 ms maximum (at the rated coil voltage, excluding contact bounce time)	
Release Time (at 20°C)	10 ms maximum (at the rated coil voltage, excluding contact bounce time)	
Insulation Resistance	100 M Ω minimum (500V DC megger)	
Impulse Withstand Voltage	10,000V AC (between contact and coil)	
Dielectric Strength	Between contact and coil	5,000V AC, 1 minute
	Between contacts of the same pole	1,000V AC, 1 minute
	Between contacts of the different poles	3,000V AC, 1 minute
Vibration Resistance	Operating Extremes	10 to 55 Hz, amplitude 0.75 mm
	Damage Limits	10 to 55 Hz, amplitude 0.75 mm
Shock Resistance	Operating Extremes	NO contact: 200 m/s ² , NC contact: 100 m/s ²
	Damage Limits	1,000 m/s ²
Electrical Life	AC load: 100,000 operations minimum (operating frequency 1,800 per hour) DC load: 200,000 operations minimum (operating frequency 1,800 per hour)	
Mechanical Life	AC load: 10 million operations minimum (operating frequency 18,000 operations per hour) DC load: 20 million operations minimum (operating frequency 18,000 operations per hour)	
Operating Temperature (100% rated voltage)	-40 to +70°C (no freezing)	
Operating Humidity	5 to 85% RH (no condensation)	
Storage Temperature	-40 to +85°C (no freezing)	
Storage Humidity	5 to 85% RH (no condensation)	
Weight (approx.)	DPDT: 17g, DPST-NO: 16g	

RJ series Slim Power Relays PC Board Terminal (bifurcated contacts)

Dimensions

RJ22V-C-*

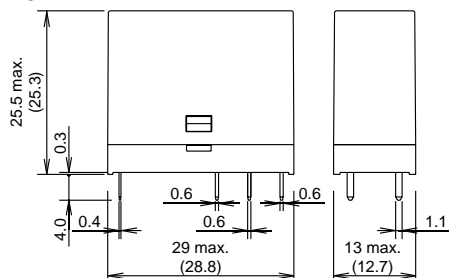

RJ22V-A-*



Mounting Hole Layout

RJ22V-C-*

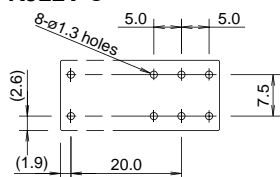

RJ22V-A-*

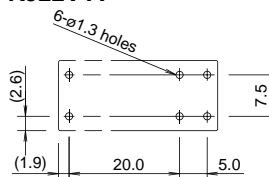

All dimensions in mm.

Internal Circuit Diagram (Bottom View)

RJ22V-C-*

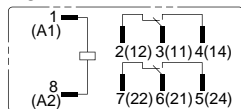

RJ22V-A-*

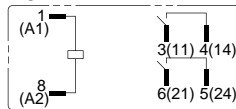

Operating Temperature and Coil Temperature Rise

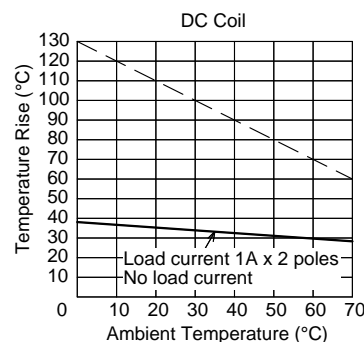
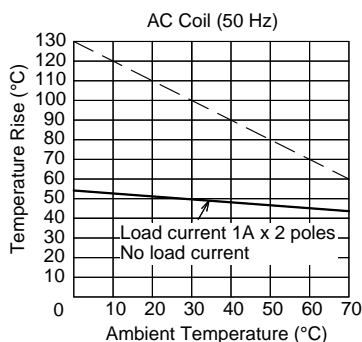
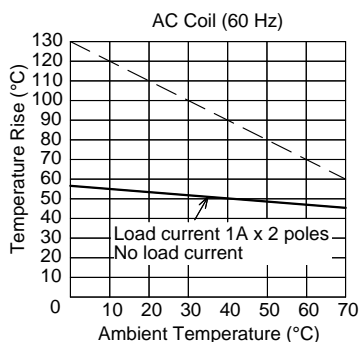

- The slanted dashed line indicates the allowable temperature rise for the coil at different ambient temperatures.
- The above temperature rise curves show the characteristics when 100% of the rated coil voltage is applied.







Safety Precautions

- Turn off the power to the RJ relay before starting installation, removal, wiring, maintenance, and inspection. Failure to turn power off may cause electrical shock or fire hazard.
- Observe the specifications and rated values, otherwise electrical shock or fire hazard may be caused.
- Use wires of the proper size to meet the voltage and current requirements.
- Tighten terminal screws to a proper tightening torque.

RU series Universal Relays

Full featured universal miniature relays Designed with environment taken into consideration

- Two terminal styles: plug-in and PCB mount
- Non-polarized LED indicator available on plug-in relays
- No internal wires, lead-free construction
- Cadmium-free contacts
- Mechanical flag indicator available on plug-in relays
- Manual latching lever with color coding for AC or DC coil
- Snap-on yellow marking plate; optional marking plates are available in four other colors
- Maximum contact ratings: 10A (RU2), 6A (RU4), 3A (RU42)
- UL, CSA, c-UL, EN compliant
- Lloyd Register type approved.

Applicable Standard	Mark	Certification Organization / File No.
UL508 CSA C22.2 No. 14		UL Recognized File No. E66043
CSA C22.2 No. 14		CSA File No. LR35144
EN61810-1		TÜV SÜD
		EU Low Voltage Directive



With Latching Lever

Mechanical Indicator

The contact position can be confirmed through the five small windows.

Lever in the Latched Position

Marking Plate

Standard yellow marking plate is easily replaced with optional marking plates in four colors for easy identification of relays.

LED Indicator

Non-polarized green LED indicator is standard provision for plug-in terminal, latching lever types



Latching Lever

Using the latching lever, operation can be checked without energizing the coil. The latching lever is color coded for AC and DC coils.

AC coil: Orange
DC coil: Green

In Normal Operation



Note: Turn off the power to the relay coil when using the latching lever. After checking the operation, return the latching lever in the normal position.

Without Latching Lever

AC/DC Color Marking

For identification of AC or DC coils.
AC coil: Yellow
DC coil: Blue

Mechanical Indicator

Marking Plate

LED Indicator

Non-polarized green LED indicator is standard provision for plug-in terminal, except for simple types.

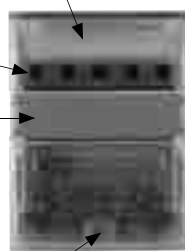

AC Coil

DC Coil

Relay Coil Tape Colors

Coil Rated Voltage	Tape Color
24V AC	White
100 to 110V AC	Clear
110 to 120V AC	Blue
200 to 220V AC	Black
220 to 240V AC	Red
24V DC	Green
6V DC	Voltage marking on yellow tape
12V DC	
48V DC	
110V DC	

RU Series Universal Relays

Single Contact

Termination	Latching Lever	Style	Part No.		Coil Voltage Code *
			DPDT	4PDT	
Plug-in Terminal (Note 1)	With Latching Lever	Standard	RU2S-*	RU4S-*	A24, A100, A110, A200, A220 D6, D12, D24, D48, D110
		With RC (AC coil only)	RU2S-R-*	RU4S-R-*	A100, A110, A200, A220
		With diode (DC coil only)	RU2S-D-*	RU4S-D-*	D6, D12, D24, D48, D110
		With diode (DC coil only) Reverse polarity coil	RU2S-D1-*	RU4S-D1-*	D24
	Without Latching Lever	Standard	RU2S-C-*	RU4S-C-*	A24, A100, A110, A200, A220 D6, D12, D24, D48, D110
		With RC (AC coil only)	RU2S-CR-*	RU4S-CR-*	A100, A110, A200, A220
		With diode (DC coil only)	RU2S-CD-*	RU4S-CD-*	D6, D12, D24, D48, D110
		With diode (DC coil only) Reverse polarity coil	RU2S-CD1-*	RU4S-CD1-*	D24
		Simple (Note 2)	RU2S-NF-*	RU4S-NF-*	A24, A100, A110, A200, A220 D6, D12, D24, D48, D110
	PCB Terminal	Without Latching Lever	Simple (Note 2)	RU2V-NF-*	RU4V-NF-*

Bifurcated Contact

Termination	Latching Lever	Style	Part No.	Coil Voltage Code *
			4PDT	
Plug-in Terminal (Note 1)	With Latching Lever	Standard	RU42S-*	A24, A100, A110, A200, A220 D6, D12, D24, D48, D100, D110
		With RC (AC coil only)	RU42S-R-*	A100, A110, A200, A220
		With diode (DC coil only)	RU42S-D-*	D6, D12, D24, D48, D100, D110
		With diode (DC coil only) Reverse polarity coil	RU42S-D1-*	D24
	Without Latching Lever	Standard	RU42S-C-*	A24, A100, A110, A200, A220 D6, D12, D24, D48, D100, D110
		With RC (AC coil only)	RU42S-CR-*	A100, A110, A200, A220
		With diode (DC coil only)	RU42S-CD-*	D6, D12, D24, D48, D100, D110
		With diode (DC coil only) Reverse polarity coil	RU42S-CD1-*	D24
		Simple (Note 2)	RU42S-NF-*	A24, A100, A110, A200, A220 D6, D12, D24, D48, D100, D110
	PCB Terminal	Without Latching Lever	Simple (Note 2)	RU42V-NF-*

Note 1: Plug-in terminal, except for simple types, have an LED indicator and a mechanical indicator as standard.

Note 2: Simple types do not have an LED indicator, a mechanical indicator, and a latching lever.

Part No. Development

Specify a coil voltage code in place of * in the Part No.

Coil Voltage Code *	Coil Rating
A24	24V AC
A100	100-110V AC
A110	110-120V AC
A200	200-220V AC
A220	220-240V AC
D6	6V DC
D12	12V DC
D24	24V DC
D48	48V DC
D100	100V DC
D110	110V DC

Accessory

Name	Part No.	Ordering No.	Color Code *	Package Quantity
Marking Plate	RU9Z-P*	RU9Z-P*PN10	A (orange), G (green), S (blue), W (white), Y (yellow)	10

Note: Specify a color code in place of the Part No. When ordering, specify the Ordering No.

The marking plate can be removed from the relay by inserting a flat screwdriver under the marking plate.

RU Series Universal Relays

Coil Ratings

Rated Voltage (V)	Coil Voltage Code	Rated Current (mA) ±15% (at 20°C)		Coil Resistance (Ω) ±10% (at 20°C)	Operating Characteristics (against rated values at 20°C)			
		50 Hz	60 Hz		Maximum Continuous Applied Voltage	Minimum Pickup Voltage	Dropout Voltage	
AC (50/60 Hz)	24	A24	49.3	42.5	110%	80% maximum	30% minimum	
	100-110	A100	9.2-11.0	7.8-9.0				164
	110-120	A110	8.4-10.0	7.1-8.2				3,460
	200-220	A200	4.6-5.5	4.0-4.6				4,550
	220-240	A220	4.2-5.0	3.6-4.2				14,080
DC	6	D6	155		110%	80% maximum	10% minimum	
	12	D12	80					40
	24	D24	44.7					160
	48	D48	18					605
	100	D100	9.7					2,560
	110	D110	8.9					10,000
			3.6-4.2		18,230			

Note 1: The rated current includes the current draw by the LED indicator.

Note 2: Rated voltage 100V DC is available for the bifurcated contact only.

Contact Ratings

Contact	Continuous Current	Allowable Contact Power		Voltage (V)	Rated Load		
		Resistive Load	Inductive Load		Res. Load	Ind. Load	Electrical Life (operations)
DPDT (RU2)	10A	2500VA AC 300W DC	1250VA AC 150W DC	250 AC	10A	5A	100,000 min.
					5A	—	500,000 min.
				30 DC	—	2.5A	300,000 min.
					10A	5A	100,000 min.
4PDT (RU4)	6A	1500VA AC 180W DC	600VA AC 90W DC	250 AC	6A	2.6A	50,000 min.
					3A	0.8A	200,000 min.
				30 DC	6A	2.7A	50,000 min.
					3A	1.5A	200,000 min.
4PDT (RU42) bifurcated	3A	750VA AC 90W DC	200VA AC 45W DC	250 AC	0.65A	0.33A	50,000 min.
					0.33A	0.18A	200,000 min.
				30 DC	3A	1.5A	100,000 min.
					110 DC	0.44A	0.22A

Note 1: On 4PDT relays, the maximum allowable total current of neighboring two poles is 6A. At the rated load, make sure that the total current of neighboring two poles does not exceed 6A (3A + 3A = 6A).

Note 2: Inductive load for the rated load — $\cos \theta = 0.3$, L/R = 7 ms

UL and c-UL Ratings

Voltage	Resistive			General Use			Horse Power Rating		
	RU2	RU4	RU42	RU2	RU4	RU42	RU2	RU4	RU42
250V AC	10A	—	—	—	6A	3A	—	1/10HP	—
30V DC	10A	6A	3A	—	—	—	—	—	—

CSA Ratings

Voltage	Resistive			General Use			Horse Power Rating		
	RU2	RU4	RU42	RU2	RU4	RU42	RU2	RU4	RU42
250V AC	10A	—	—	—	6A	3A	—	1/10HP	—
30V DC	10A	6A	3A	—	—	—	—	—	—

TÜV Ratings

Voltage	Resistive			Inductive		
	RU2	RU4	RU42	RU2	RU4	RU42
250V AC	10A	6A	3A	5A	0.8A	0.8A
30V DC	10A	6A	3A	5A	1.5A	1.5A

Surge Suppressor Ratings

Type	Ratings
AC Coil	With RC RC series circuit R: 20 kΩ, C: 0.033 μF
DC Coil	With Diode Diode reverse voltage: 1000V Diode forward current: 1A

Specifications

Model	RU2 (DPDT)	RU4 (4PDT)	RU42 (4PDT)
Contact Material	Silver alloy	Silver (gold clad)	Silver-nickel (gold clad)
Contact Resistance *1	50 mΩ maximum		
Minimum Applicable Load *2	24V DC, 5 mA	1V DC, 1 mA	1V DC, 0.1 mA
Operate Time *3	20 ms maximum		
Release Time *3	20 ms maximum		
Power Consumption	AC: 1.1 to 1.4VA (50 Hz), 0.9 to 1.2VA (60 Hz) DC: 0.9 to 1.0W		
Insulation Resistance	100 MΩ minimum (500V DC megger)		
Dielectric Strength	Between contact and coil: 2500V AC, 1 minute		
	Between contacts of different poles: 2500V AC, 1 minute		
	Between contacts of the same pole: 1000V AC, 1 minute		
Operating Frequency	Electrical: 1800 operations/h maximum Mechanical: 18,000 operations/h maximum		
Vibration Resistance	Damage limits: 10 to 55 Hz, amplitude 0.5 mm Operating extremes: 10 to 55 Hz, amplitude 0.5 mm		
Shock Resistance	Damage limits: 1000 m/s ² Operating extremes: 150 m/s ²		
Mechanical Life	AC: 50,000,000 operations DC: 100,000,000 operations		50,000,000 operations
Electrical Life	See page 27 and 29.		
Operating Temperature *4	PCB terminal: -55 to +70°C (no freezing) Others: -55 to +60°C (no freezing)		
Operating Humidity	5 to 85% RH (no condensation)		
Storage Temperature	-55 to +70°C RH (no freezing)		
Storage Humidity	5 to 85% RH (no condensation)		
Weight	Approx. 35g		

Note: Above values are initial values.

*1: Measured using 5V DC, 1A voltage drop method

*2: Measured at operating frequency of 120 operations/min (failure rate level P, reference value)

*3: Measured at the rated voltage (at 20°C), excluding contact bouncing;
Release time of AC relays with RC: 25 ms maximum
Release time of DC relays with diode: 40 ms maximum

*4: Measured at the rated voltage.

RU Series Universal Relays

RU2 (DPDT Contact)

Plug-in Terminal



- LED indicator, mechanical flag indicator, and marking plate are standard provisions, except on simple types.
- Available with or without a manual latching lever



Photo: RU2S-A100

PCB Terminal



- Marking plate is a standard provision.
- Not provided with an LED indicator, mechanical flag indicator, and manual latching lever.



Photo: RU2V-NF-A100

Dimensions

RU2S

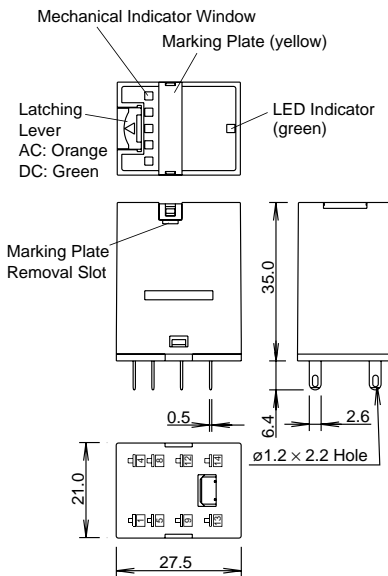

RU2S-C/RU2S-NF

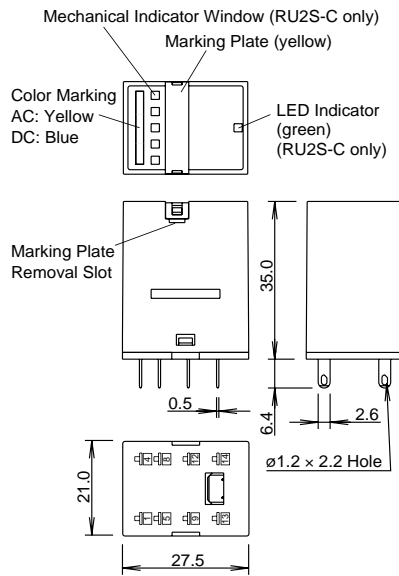

RU2V

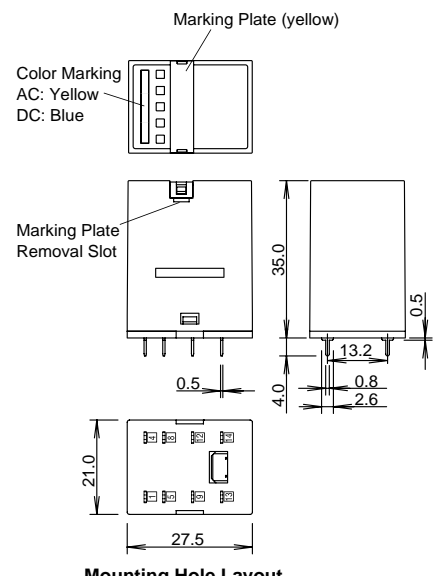

Mounting Hole Layout

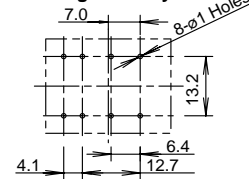

All dimensions in mm.

Marking plate removal slot is provided only on one side. Insert a flat screwdriver into the slot to remove the marking plate.

Internal Connection (Bottom View)

RU2S-* Standard

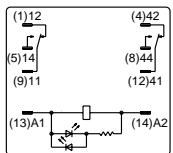

24V AC/DC or less

RU2S-*R With RC

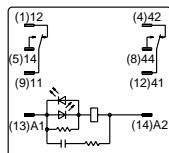

RU2S-*D With Diode

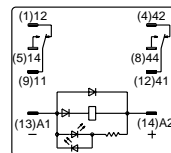

24V DC or less

RU2S-*D1 With Diode Reverse Polarity Coil

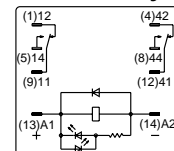

24V DC

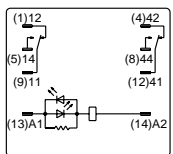

Over 24V AC/DC

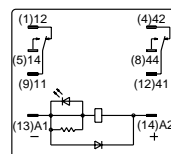

Over 24V DC

RU2S-NF-* /RU2V-NF-*

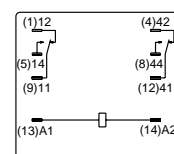

Blank or C comes in place of * to represent types with or without a latching lever.

RU Series Universal Relays

Electrical Life Curves

RU2 (Resistive Load)

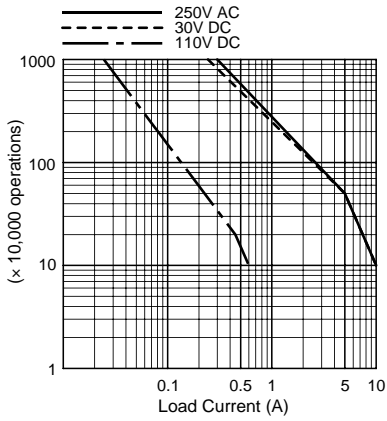

RU2 (Inductive Load)

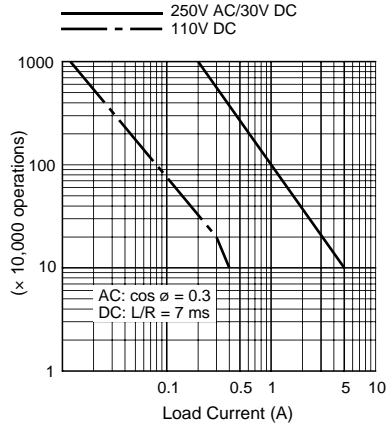

Maximum Switching Current

RU2

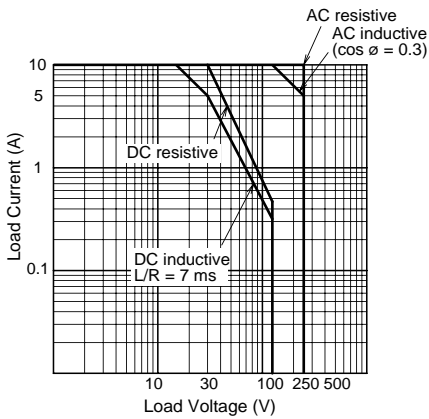

Ambient Temperature vs. Temperature Rise Curves

RU2 (AC Coil, 50 Hz)

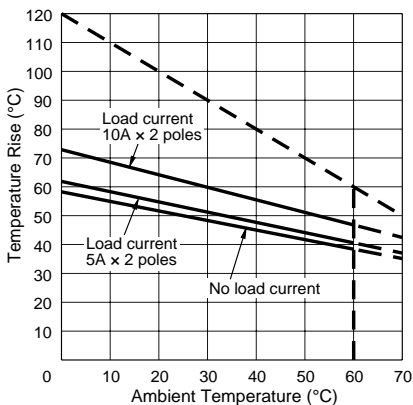

RU2 (AC Coil, 60 Hz)

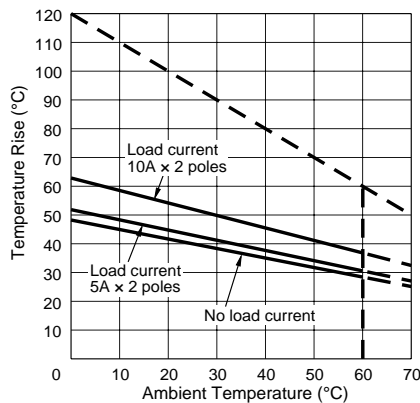

RU2 (DC Coil)

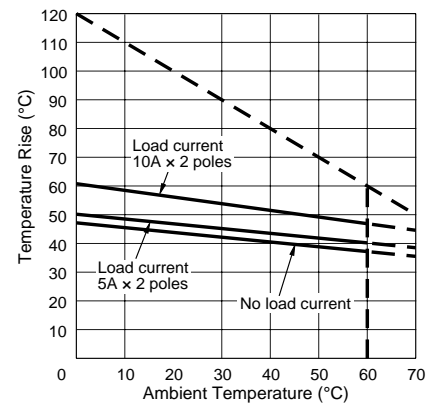

The above temperature rise curves show the characteristics when 100% the rated coil voltage is applied. The heat resistance of the coil is 120°C. The slant dashed line indicates the allowable temperature rise for the coil at different ambient temperatures.

RU Series Universal Relays

RU4 (4PDT Contact)

Plug-in Terminal



- LED indicator, mechanical flag indicator, and marking plate are standard provisions, except on simple types.
- Available with or without a manual latching lever



Photo: RU42S-A100

PCB Terminal



- Marking plate is a standard provision.
- Not provided with an LED indicator, mechanical flag indicator, and manual latching lever.



Photo: RU4V-NF-D24

Dimensions

RU4S/RU42S

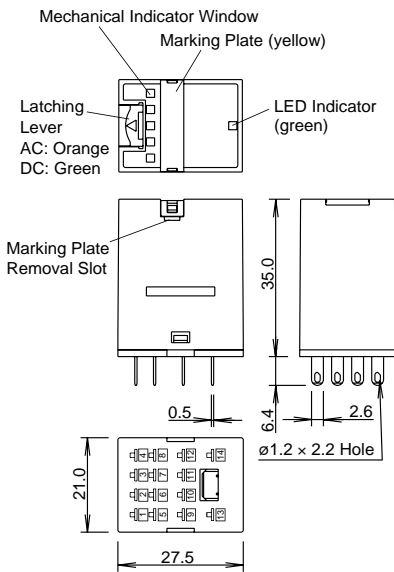

RU4S-C/RU4S-NF RU42S-C/RU42S-NF

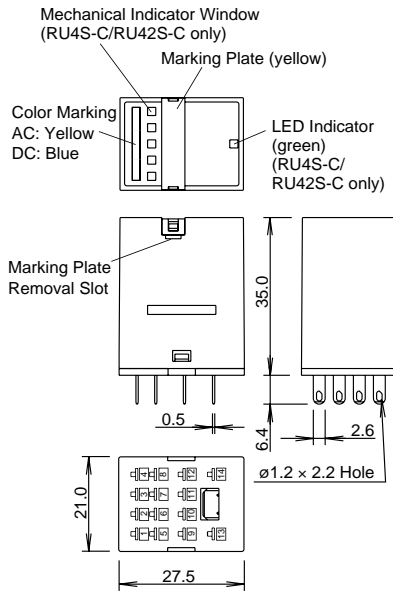

RU4V/RU42V

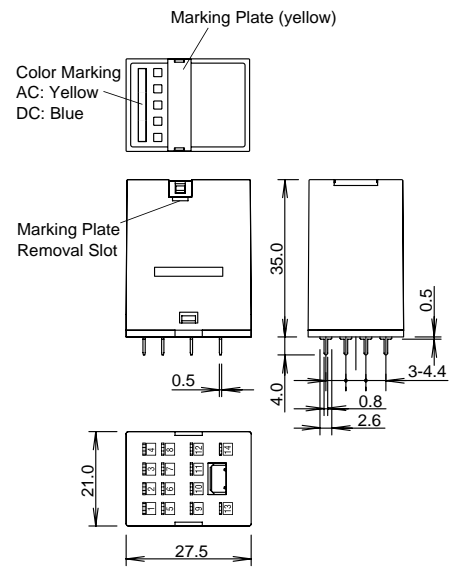

Mounting Hole Layout

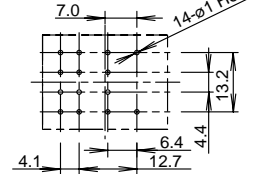

All dimensions in mm.

Marking plate removal slot is provided only on one side. Insert a flat screwdriver into the slot to remove the marking plate.

Internal Connection (Bottom View)

RU4S-*/RU42S-*

Standard

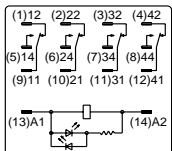

24V AC/DC or less

RU4S-*/R/RU42S-*/R

With RC

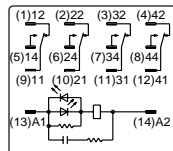

RU4S-*/D/RU42S-*/D

With Diode

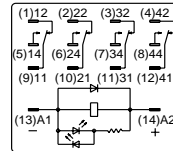

24V DC or less

RU4S-*/D1/RU42S-*/D1

With Diode
Reverse Polarity Coil

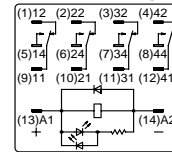

24V DC

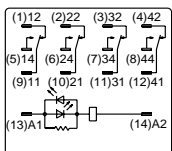

Over 24V AC/DC

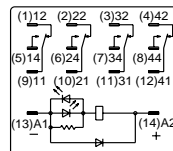

Over 24V DC

RU4S-NF-*/RU4V-NF-*

RU42S-NF-*/RU42V-NF-*

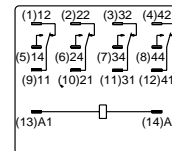

Blank or C comes in place of * to represent types with or without a latching lever.

RU Series Universal Relays

Electrical Life Curves

RU4 (Resistive Load)

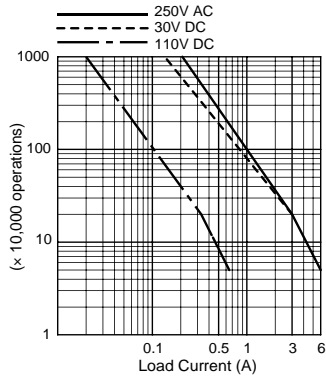

RU4 (Inductive Load)

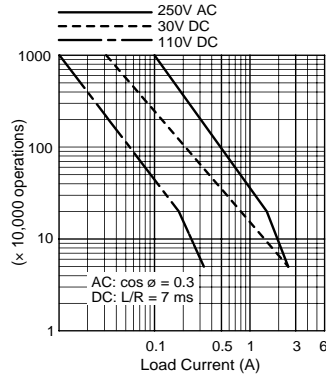

RU42 (Resistive Load)

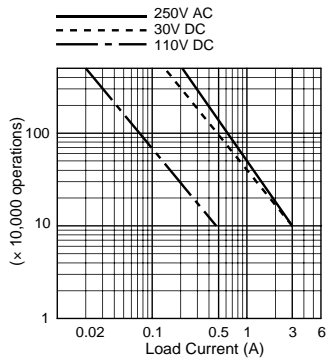

RU42 (Inductive Load)

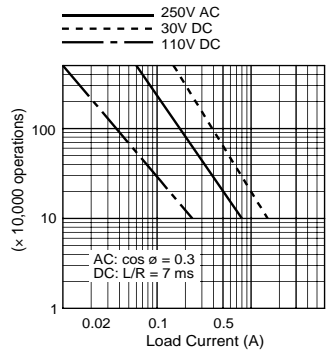

Maximum Switching Current

RU4 (Rated Load)

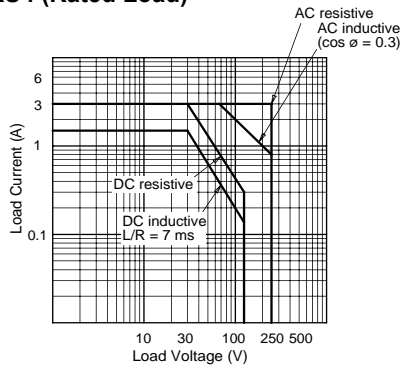

RU4 (Maximum Load)

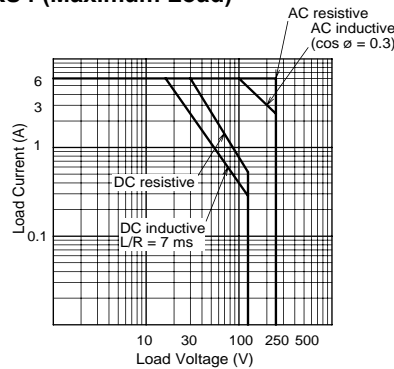

RU42

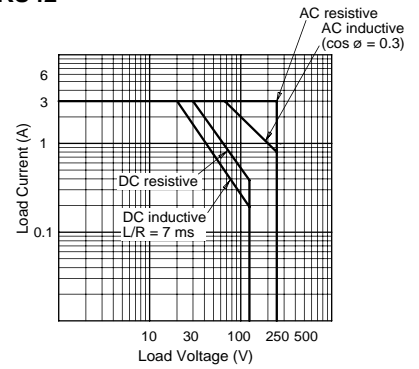

Ambient Temperature vs. Temperature Rise Curves

RU4/RU42 (AC Coil, 50 Hz)

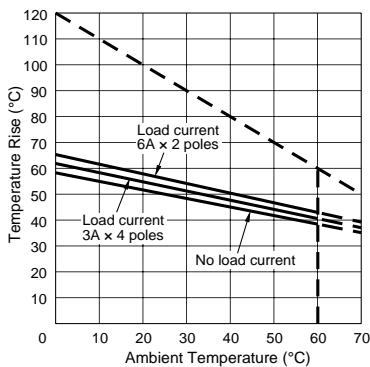

RU4/RU42 (AC Coil, 60 Hz)

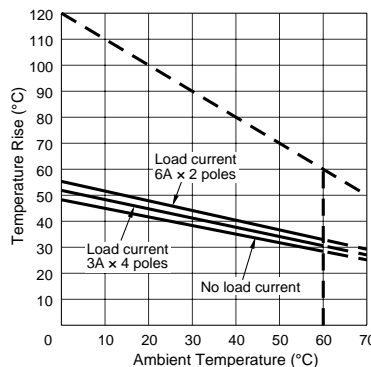

RU4/RU42 (DC Coil)

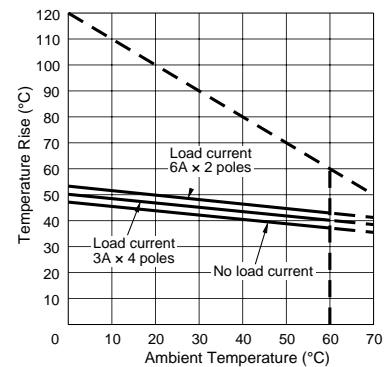































The above temperature rise curves show the characteristics when 100% the rated coil voltage is applied.

Load current 6A x 2 poles is for the RU4 only.

The heat resistance of the coil is 120°C. The slant dashed line indicates the allowable temperature rise for the coil at different ambient temperatures.

RU series Universal Relays

Applicable Socket

Relay	Wiring Style	Shape	Part No.	Rated Current	Style	Applicable Spring		
						Hold-down Spring	Wire Spring	
RU2	Front Wiring Socket		SM2S-05A	7A	—	SFA-202 SFA-101	—	
			SM2S-05C (Note 1)	7A (UL:10A)	Finger-safe 			
			SM2S-05D	10A	Slim 	SFA-503		
			SM2S-05DF	10A	Finger-safe 			
			SU2S-11L	10A 8A (collective mounting) (Note 3)	Spring-clamp (Note 2) 	SFA-202 SFA-101		—
	Rear Wiring Socket		SM2S-51	10A	Solder 	SFA-301 SFA-302	SY4S-51F1	
			SM2S-61	10A	PC board 			
			SM2S-62	10A	PC board 	SFA-504		SY4S-51F1
	RU4 RU42	Front Wiring Socket		SY4S-05A	7A	—	SFA-202 SFA-101	—
			SY4S-05C (Note 1)	7A	Finger-safe 			
			SY4S-05D	6A	Slim 	SFA-502		
			SY4S-05DF (Note 1)	6A	Finger-safe 	SFA-502	—	
			SU4S-11L	6A (4-pole) 10A (2-pole) 8A (2-pole, collective mounting) (Note 3)	Spring-clamp (Note 2) 	SFA-202 SFA-101	—	
Rear Wiring Socket			SY4S-51	7A	Solder 	SFA-301 SFA-302	SY4S-51F1	
			SY4S-61	7A	PC board 			
			SY4S-62	7A	PC board 	SFA-504		SY4S-51F1

Package quantity: 1

Note 1: Finger-safe cannot be used with ring terminal.









Note 2: SU2S-11L and SU4S-11L are spring-clamp socket which does not require tightening screws. Stranded wire, solid wire, and ferrule can be attached using a screwdriver.

Note 3: When using SU2S-11L and SU4S-11L at rated current 8A and above, maintain at least 10mm distance from the adjacent SU socket.

Note 4: Front wiring socket can be mounted directly on DIN rail and mounting panel (some sockets need spacers for the ends).

RU Series Universal Relays

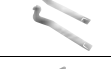
Hold-down Springs







Style	Shape	Material	Part No.	Ordering No.	Package Quantity
Wire Spring		Stainless Steel	SY4S-51F1	SY4S-51F1PN10	10
Leaf Spring			SFA-101	SFA-101PN20	10 pairs
			SFA-202	SFA-202PN20	
			SFA-301	SFA-301PN20	
			SFA-302	SFA-302PN20	
			SFA-502	SFA-502PN20	
			SFA-503	SFA-503PN20	
			SFA-504	SFA-504PN10	10

Note 1: A relay needs a pair of leaf springs, except for SFA-504 (one spring per relay).

Note 2: When the wire spring SY4S-51F1 or leaf spring SFA-504 is used on a relay with latching lever, lever cannot be opened or closed.

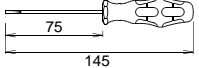
Note 3: Leaf springs (except for the leaf spring SFA-504) cannot be removed after being installed on a socket (except for SM2S-05D and SY4S-05D)

Accessories for Sockets

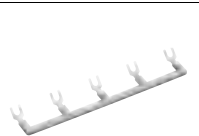
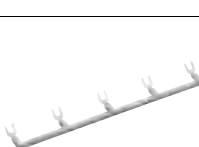
Name	Shape	Specifications	Part No.	Ordering No.	Package Quantity	Remarks
DIN Rail		Aluminum Weight: Approx. 200g	BAA1000	BAA1000PN10	10	Length: 1m Width: 35 mm
		Steel Weight: Approx. 320g	BAP1000	BAP1000PN10	10	
End Clip		Zinc-plated steel Weight: Approx. 15g	BNL5	BNL5PN10	10	Used on a DIN rail to fasten relay sockets
			BNL6	BNL6PN10	10	
Applicable Screwdriver		Weight: 20g (approx.)	BC1S-SD0	BC1S-SD0	1	Used for spring clamp connection (SU2S, SU4S sockets)
DIN Rail Spacer		Plastic (black)	SA-406B	SA-406B	1	Thickness: 5 mm Used for adjusting spacing between sockets mounted on a DIN rail
End Spacer		Plastic (black)	SA-203B	SA-203B	1	Used for mounting DIN rail mount sockets directly on a panel surface
Intermediate Spacer			SA-204B	SA-204B	1	
Jumper		Brass jumper with ABS sheath Rated current: 3A Weight: Approx. 3g	SU9Z-J5	SU9Z-J5PN10	10	Used for interconnecting relay coil terminals on a maximum of five SU sockets; can be cut to required lengths
Jumper			SM9Z-JF2	SM9Z-JF2PN10	10	Used for interconnecting relay coil terminals on SM2S-05DF sockets; can be cut to required length. No. of sockets: SM9Z-JF2: 2 SM9Z-JF5: 5 SM9Z-JF8: 8
			SM9Z-JF5	SM9Z-JF5PN10		
			SM9Z-JF8	SM9Z-JF8PN10		
			SY9Z-JF2	SY9Z-JF2PN10		Used for interconnecting relay coil terminals on SY4S-05DF sockets; can be cut to required length SY9Z-JF2: 2 SY9Z-JF5: 5 SY9Z-JF8: 8
			SY9Z-JF5	SY9Z-JF5PN10		
			SY9Z-JF8	SY9Z-JF8PN10		

RU Series Universal Relays

Instructions

- Before operating the latching lever, turn off the power to the RU relay. After checking the circuit, return the latching lever to the original position.
- Do not use the latching lever as a switch.
- The durability of the latching lever is a minimum of 100 operations.
- When using DC loads on 4PDT relays, apply a positive voltage to terminals of neighboring poles and a negative voltage to the other terminals of neighboring poles to prevent the possibility of short circuits.
- DC relays with a diode have a polarity in the coil terminals.
- The surge absorbing element on AC relays with RC or DC relays with diode is provided to absorb the counter electromotive force generated by the coil. When the relay is subject to an excessive external surge voltage, the surge absorbing element may be damaged. Add another surge absorbing provision to the relay to prevent damage.

Safety Precautions

1. Notes on soldering

- When mounting 2 or more relays on a PC board, keep a minimum spacing of 5 mm in each direction.
- Manual soldering: Solder the terminals at 350°C within 3 sec., using a soldering iron of 60W (Sn-Ag-Cu is recommended when using lead-free solder).
- Auto-soldering: Solder at 250°C within 4 to 5 sec.
- Use a non-corrosive resin flux.





2. Color coding of coil voltage

Coil Voltage	Color
24V AC	White
100~110V AC	Clear
110~120V AC	Blue
200~220V AC	Black
220~240V AC	Red
24V DC	Green
6V DC	Voltage marking on yellow tape
12V DC	
48V DC	
100V DC	
110V DC	

RY Series Miniature Relays

DPDT and 4PDT contacts (3A) Bifurcated contacts are also available

The RY series are general purpose miniature relays with a 3A contact capacity. A wide variety of terminals styles and coil voltages meet a wide range of applications. All 4PDT have arc barriers. The 4PDT also available with reverse polarity diode and LED.

Applicable Standards	Mark	Certification Organization/ File No.
UL508		UL recognized, File No. E55996
CSA C22.2 No. 14		CSA File No. LR35144
EN61810-1		TÜV SÜD
		EU Low Voltage Directive

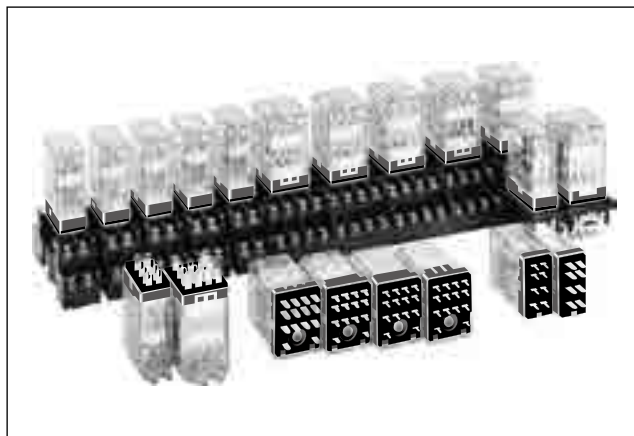

Plug-in Terminal

Terminal	Style	DPDT		4PDT			
		Part No.	Coil Voltage Code *	Part No.	Coil Voltage Code *		
Standard	Basic	RY2S-U* ★	AC6, AC12, AC24, AC50, AC100, AC110, AC115, AC120, AC200, AC220, AC230, AC240 DC6, DC12, D24, DC48, DC100, DC110	RY4S-U* ★	AC6, AC12, AC24, AC50, AC100-110, AC110-120, AC200-220, AC220-240 DC6, DC12, DC24, DC48, DC100-110		
	With Indicator	RY2S-UL* ★		RY4S-UL* ★			
	With Reverse Polarity Indicator	—		RY4S-UL1* ★			
	With Check Button	—		RY4S-UC* ★			
	With Indicator and Check Button	—		RY4S-ULC* ★			
	Top Bracket Mounting	RY2S-UT* ★		RY4S-UT* ★			
	With Diode (DC coil only)	RY2S-UD* ★		RY4S-UD* ★		DC6, DC12, DC24, DC48, DC100, DC110	
	With Reverse Polarity Diode (DC coil only)	—					RY4S-UD1*
	With Indicator and Diode (DC coil only)	RY2S-ULD*					RY4S-ULD* ★
	With Indicator and Reverse Polarity Diode (DC coil only)	—					RY4S-UL1D1*

PC Board Terminal

Terminal	Style	DPDT		4PDT	
		Part No.	Coil Voltage Code *	Part No.	Coil Voltage Code *
Standard	Standard	RY2V-U* ★	AC6, AC12, AC24, AC50, AC100, AC110, AC115, AC120, DC6, DC12, DC24, DC48	RY4V-U* ★	AC6, AC12, AC24, AC50, AC100-110, AC110-120, AC200-220, AC220-240 DC6, DC12, DC24, DC48, DC100-110
	With Indicator	RY2V-UL* ★		RY4V-UL* ★	
	With Diode (DC coil only)	RY2V-UD* ★		—	

Part numbers marked with ★ in the tables above are UL-recognized, CSA-certified, and TÜV-approved.

Part No. Development

When ordering, specify the Part No. and coil voltage code.

(Example) **RY4S-U** **AC100-110**
 Part No. Coil Voltage Code

R_Y Series Miniature Relays

Coil Ratings

	Rated Voltage (V)		Rated Current (mA) ±15% at 20°C				Coil Resistance (Ω) ±10% at 20°C		Operation Characteristics (against rated values at 20°C)		
			50Hz		60Hz				Max. Continuous Applied Voltage	Min. Pickup Voltage	Dropout Voltage
	DPDT	4PDT	DPDT	4PDT	DPDT	4PDT	DPDT	4PDT			
AC (50/60Hz)	6	6	170	240	150	200	18.8	9.34	110%	80% maximum	30% minimum
	12	12	86	121	75	100	76.8	39.3			
	24	24	42	60.5	37	50	300	152			
	50	50	20.5	28.9	18	24	1,280	676			
	100	100-110	10.5	10.3-11.8	9	9.1-10.0	5,220	3,360			
	110	—	9.6	—	8.4	—	6,950	—			
	115	110-120	8.9	9.4-10.8	7.8	8.0-9.2	7,210	4,290			
	120	—	8.6	—	7.5	—	8,100	—			
	200	200-220	5.6	5.1-5.9	4.9	4.3-5.0	21,442	13,690			
	220	—	4.7	—	4.1	—	25,892	—			
	230	220-240	4.7	4.7-5.4	4.1	4.0-4.6	26,710	18,820			
240	—	4.9	—	4.3	—	26,710	—				
DC	DPDT	4PDT	DPDT		4PDT		DPDT	4PDT	110%	80% maximum	10% minimum
	6	6	128		150		47	40			
	12	12	64		75		188	160			
	24	24	32		36.9		750	650			
	48	48	18		18.5		2,660	2,600			
	100	100-110	10		8.2-9.0		10,000	12,250			
	110	—	8		—		13,800	—			

Contact Ratings

Maximum Contact Capacity						
Contact	Continuous Current	Allowable Contact Power		Rated Load		
		Resistive Load	Inductive Load	Voltage	Resistive Load	Inductive Load
Standard Contact DPDT 4PDT	3A	660 VA AC 90W DC	176 VA AC 45W DC	110V AC	3A	1.5A
				220V AC	3A	0.8A
				30V DC	3A	1.5A

Note: Inductive load for the rated load — $\cos \phi = 0.3$, L/R = 7 ms

Standard Ratings

R_{Y2}

UL Ratings (Standard Contact)

Voltage	Resistive	General use
240V AC	3A	0.8A
120V AC	—	1.5A
100V DC	0.2A	0.2A
30V DC	3A	3A

CSA Ratings (Standard Contact)

Voltage	Resistive	General use
240V AC	3A	0.8A
120V AC	3A	1.5A
100V DC	—	0.2A
30V DC	3A	1.5A

TÜV Ratings (Standard Contact)

240V AC	3A
30V DC	3A

AC $\cos \phi = 1.0$,
DC L/R=0ms

R_{Y4}

UL Ratings (Standard Contact)

Voltage	Resistive	General use
240V AC	5A	5A
100V DC	0.2A	0.2A
30V DC	5A	5A

CSA Ratings (Standard Contact)

Voltage	Resistive	General use
240V AC	5A	5A
100V DC	—	0.2A
30V DC	5A	1.5A

TÜV Ratings (Standard Contact)

240V AC	5A
30V DC	5A

AC $\cos \phi = 1.0$,
DC L/R=0ms

RY Series Miniature Relays

Specifications

Contact	Standard Contact	
	DPDT	4PDT
Contact Material	Gold-plated silver	
Contact Resistance *1	50 mΩ maximum	
Minimum Applicable Load	5V DC, 10 mA (reference value)	1V DC, 1 mA (reference value)
Operate Time *2	20 ms maximum	
Release Time *2	20 ms maximum	
Power Consumption (approx.)	AC: 1.1 VA (50 Hz), 1 VA (60 Hz) DC: 0.8W	AC: 1.4 VA (50 Hz), 1.2 VA (60 Hz) DC: 0.9W
Insulation Resistance	100 MΩ minimum (500V DC megger)	
Dielectric Strength	Between live and dead parts: 1500V AC, 1 minute Between contact and coil: 1500V AC, 1 minute *3 Between contacts of different poles: 1500V AC, 1 minute Between contacts of the same pole: 1000V AC, 1 minute	Between live and dead parts: 2000V AC, 1 minute Between contact and coil: 2000V AC, 1 minute Between contacts of different poles: 2000V AC, 1 minute Between contacts of the same pole: 1000V AC, 1 minute
Operating Frequency	Electrical: 1,800 operations/h maximum Mechanical: 18,000 operations/h maximum	
Vibration Resistance	Damage limits: 10 to 55 Hz, amplitude 0.5 mm Operating extremes: 10 to 55 Hz, amplitude 0.5 mm	
Shock Resistance	Damage limits: 1,000 m/s ² Operating extremes: 100 m/s ² (DPDT), 200 m/s ² (4PDT)	
Mechanical Life	50,000,000 operations	
Electrical Life	200,000 operations (220V AC, 3A)	
Operating Temperature *4	-25 to +50°C (no freezing)	
Operating Humidity	45 to 85% RH (no condensation)	
Storage Temperature	-55 to +70°C (no freezing)	
Storage Humidity	45 to 85% RH (no condensation)	
Weight (approx.)	23g	34g

Note: Above values are initial values.

*1: Measured using 5V DC, 1A voltage drop method

*2: Measured at the rated voltage (at 20°C), excluding contact bouncing
Release time of relays with diode: 40 ms maximum

*3: Relays with indicator or diode: 1000V AC, 1 minute

*4: For use under different temperature conditions, refer to Continuous Load Current vs. Operating Temperature Curve.

The operating temperature range of relays with indicator or diode is -25 to +40°C.

Characteristics (Reference Data)

Maximum Switching Capacity

(RY2)

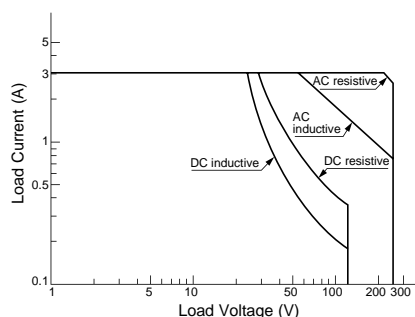

(RY4)

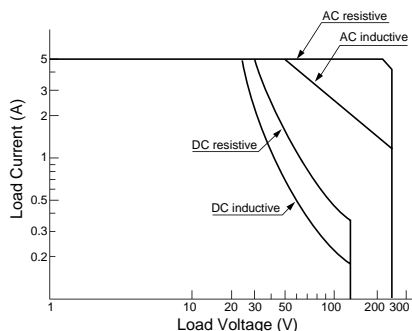

Continuous Load Current vs. Operating Temperature Curve (Basic, With Check Button, and Top Bracket Mounting)

(RY2)

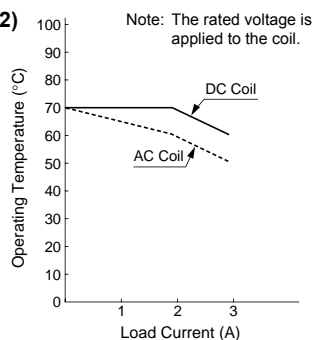

(RY4)

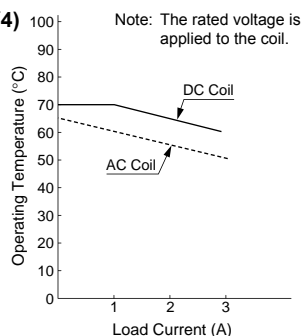

RY Series Miniature Relays

Electrical Life Curve

AC Load

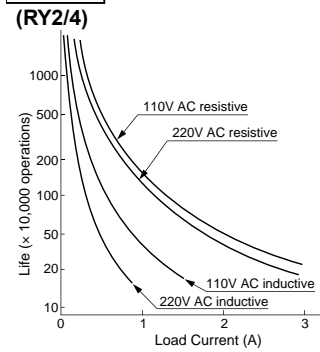

DC Load

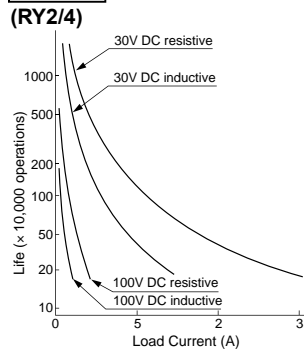

Internal Connection (Bottom View)

Basic (-U, UT)

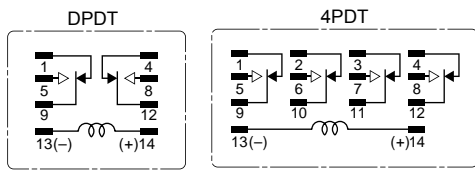

With Check Button

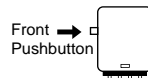

Contacts can be operated by pressing the check button. Press the button quickly to prevent arcing.

With Indicator and Diode (-ULD)

This type contains an operation indicator and a surge absorber, and has the same height as the basic type.

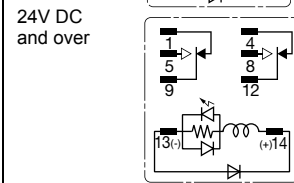
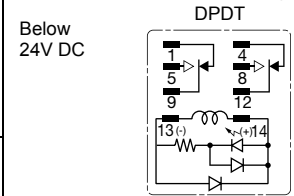

With Indicator (-UL)

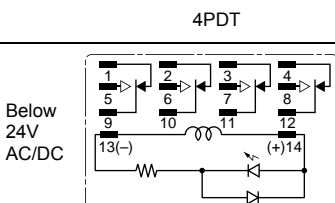
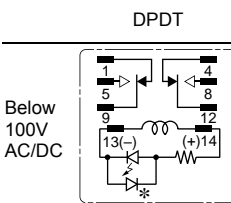

With Indicator (-UL1) (reverse polarity)

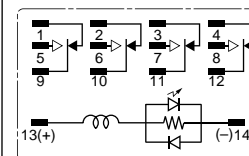
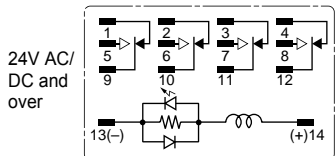
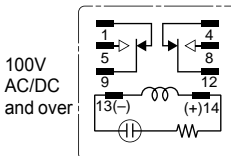
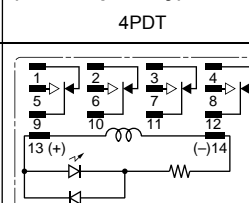

When the relay is energized, the indicator goes on.
* The LED protection diode is not contained in DPDT relays for below 100V DC.

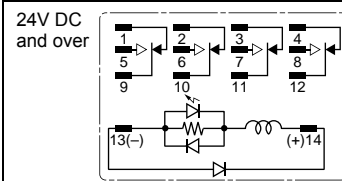
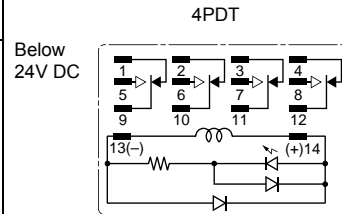

With Diode (-UD)

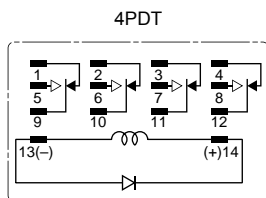
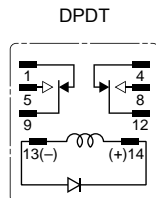

With Diode (-UD1) (reverse polarity)

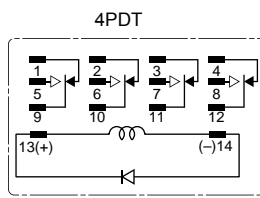

This type contains a diode to absorb the counter emf generated when the coil is deenergized. The release time is slightly longer.

- Diode Characteristics
- Reverse withstand voltage: 1,000V
- Forward current: 1A

With Indicator and Diode (-UL1D1) (reverse polarity)

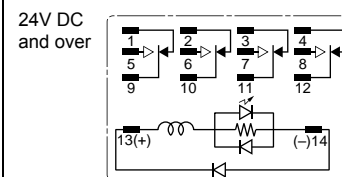
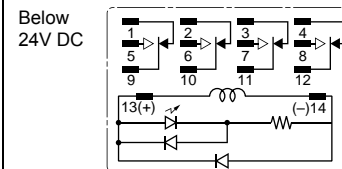

RY Series Miniature Relays

Dimensions

Plug-in Terminal

RY2S-U/RYS2-UL
RY2S-UD



(Photo: RY2S-U)

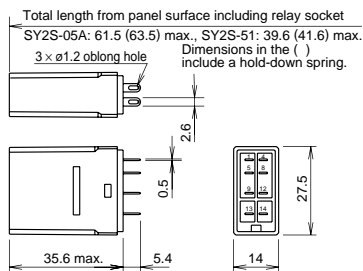

Applicable Socket and Hold-down Spring

Mounting Style	Socket	
	Part No.	Hold-down Spring
DIN Rail Mount Socket	SY2S-05*	SFA-101 SFA-202
Panel Mount Socket	SY2S-51	SY4S-51F1 SFA-301 SFA-302
PC Board Mount Socket	SY2S-61	

RY4S-U/RYS4-UL/RYS4-UD/RYS4-ULD/
RY4S-UL1/RYS4-UD1/RYS4-UL1D1



(Photo: RY4S-U)

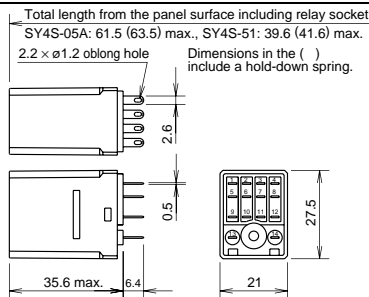

Applicable Socket and Hold-down Spring

Mounting Style	Socket	
	Part No.	Hold-down Spring
DIN Rail Mount Socket	SY4S-05*	SFA-101 SFA-202 SFA-502
Panel Mount Socket	SY4S-51	SY4S-51F1 SFA-301 SFA-302
PC Board Mount Socket	SY4S-61	(SY4S-02F1)

• (SY4S-02F1) is for the relay with check button.

PC Board Terminal

RY2V-U/RYS2V-UL/RYS2V-UD



(Photo: RY2V-U)

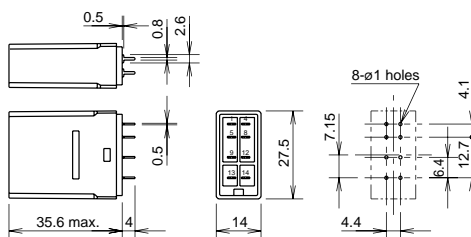

RY4V-U/RYS4V-UL



(Photo: RY4V-U)

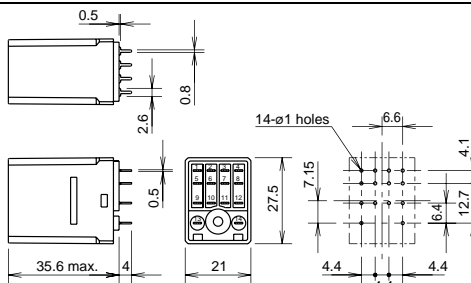

Top Bracket Mounting (Plug-in Terminal)

RY2S-UT

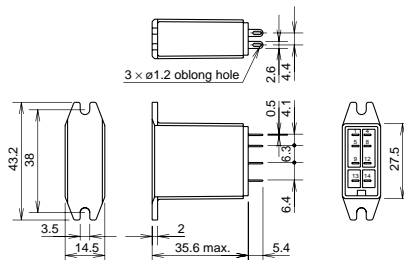

RY4S-UT

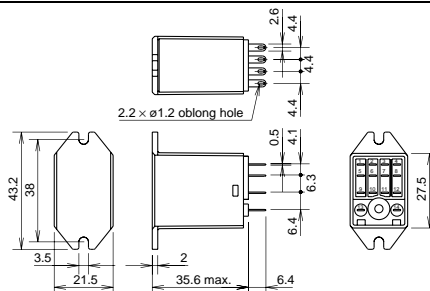





All dimensions in mm.

RM Series Miniature Relays

DPDT contacts (5A) Plug-in and PC board terminal styles

- Compact miniature size saves space
- Options include indicators and check buttons.

Standard	Mark	Certification Organization/ File No.
UL508		UL recognized, File No. E55996
CSA C22.2 No. 14		CSA File No. LR35144
EN61810-1		TÜV SÜD
		EU Low Voltage Directive

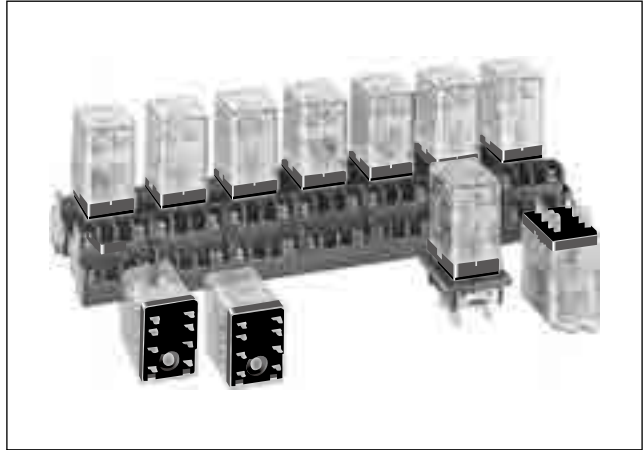

Style	Plug-in Terminal		PC Board Terminal		
	Part No.	Coil Voltage Code *	Part No.	Coil Voltage Code *	
Basic	RM2S-U* ★	AC6, AC12, AC24, AC50, AC100-110, AC110-120, AC200-220, AC220-240 DC6, DC12, DC24, DC48, DC100-110	RM2V-U* ★	AC6, AC12, AC24, AC50, AC100-110, AC110-120, AC200-220, AC220-240 DC6, DC12, DC24, DC48, DC100-110	
With Indicator	RM2S-UL* ★		RM2V-UL* ★		
With Check Button	RM2S-UC* ★		—		—
Top Bracket Mounting	RM2S-UT* ★		—		—
With Diode (DC coil only)	RM2S-UD* ★	DC6, DC12, DC24, DC48, DC100-110	—	—	
With Indicator and Diode (DC coil only)	RM2S-ULD* ★		—	—	

Part numbers marked with ★ in the table above are UL-recognized, CSA-certified, and TÜV-approved.

Part No. Development

When ordering, specify the Part No. and coil voltage code.

(Example) **RM2S-U** **AC100-110**
 Part No. Coil Voltage Code

Coil Ratings

Rated Voltage (V)	Rated Current (mA) ±15% at 20°C		Coil Resistance (Ω) ±10% at 20°C	Operation Characteristics (against rated values at 20°C)		
	50Hz	60Hz		Max. Continuous Applied Voltage	Min. Pickup Voltage	Dropout Voltage
AC (50/60Hz)	6	240	200	110%	80% maximum	30% minimum
	12	121	100			
	24	60.5	50			
	50	28.9	24			
	100-110	10.3-11.8	9.1-10.0			
	110-120	9.4-10.8	8.2-9.2			
	200-220	5.1-5.9	4.3-5.0			
	220-240	4.7-5.4	4.0-4.6			
DC	6	150		110%	80% maximum	10% minimum
	12	75				
	24	37.5				
	48	18.8				
	100-110	8.2-9.0				

RM Series Miniature Relays

Contact Ratings

Maximum Contact Capacity					
Continuous Current	Allowable Contact Power		Rated Load		
	Resistive Load	Inductive Load	Voltage	Res. Load	Ind. Load
5A	1100VA AC 150W DC	440VA AC 75W DC	110V AC	5A	2.5A
			220V AC	5A	2A
			30V DC	5A	2.5A

Note: Inductive load for the rated load — $\cos \phi = 0.3$, L/R = 7 ms

UL Ratings

Voltage	Resistive	General use
240V AC	5A	2A
120V AC	—	2.5A
100V DC	0.4A	—
30V DC	5A	—

CSA Ratings

Voltage	Resistive	General use
240V AC	5A	2A
120V AC	5A	2.5A
100V DC	—	0.4A
30V DC	5A	2.5A

TÜV Ratings

240V AC	5A
30V DC	5A

Note: AC: $\cos \phi = 1.0$, DC: L/R = 0 ms

Specifications

Contact Material	Silver
Contact Resistance	30 mΩ maximum *1
Minimum Applicable Load	5V DC, 1 mA (reference value)
Operate Time	20 ms maximum *2
Release Time	20 ms maximum *2
Power Consumption (approx.)	AC: 1.4 VA (50 Hz), 1.2 VA (60 Hz) DC: 0.9W
Insulation Resistance	100 MΩ minimum (500V DC megger)
Dielectric Strength	Between live and dead parts: 2000V AC, 1 minute *3
	Between contact and coil: 2000V AC, 1 minute
	Between contacts of different poles: 2000V AC, 1 minute
	Between contacts of the same pole: 1000V AC, 1 minute
Operating Frequency	Electrical: 1,800 operations/h maximum
	Mechanical: 18,000 operations/h maximum
Temperature Rise	Coil: 85°C maximum, Contact: 65°C maximum
Vibration Resistance	Damage limits: 10 to 55 Hz, amplitude 0.5 mm
	Operating extremes: 10 to 55 Hz, amplitude 0.5 mm
Shock Resistance	Damage limits: 1000 m/s ²
	Operating extremes: 200 m/s ²
Mechanical Life	50,000,000 operations
Electrical Life	500,000 operations (220V AC, 5A)
Operating Temperature	-25 to +45°C (no freezing) *4
Operating Humidity	45 to 85% RH (no condensation)
Storage Temperature	-55 to +70°C (no freezing) *4
Storage Humidity	45 to 85% RH (no condensation)
Weight (approx.)	35g

Note: Above values are initial values.

- *1: Measured using 5V DC, 1A voltage drop method
- *2: Measured at the rated voltage (at 20°C), excluding contact bouncing
Release time of relays with diode: 40 ms maximum
- *3: Relays with indicator or diode: 1000V AC, 1 minute
- *4: For use under different temperature conditions, refer to Continuous Load Current vs. Operating Temperature Curve. The operating temperature range of relays with indicator or diode is -25 to +40°C.

Characteristics (Reference Data)

Maximum Switching Capacity

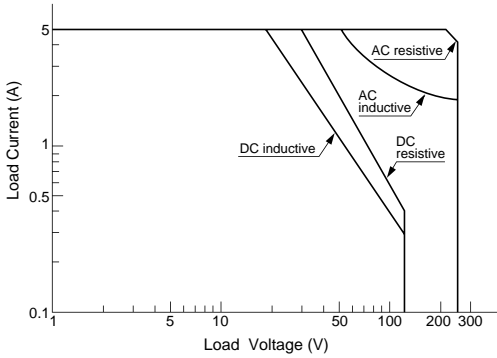

Electrical Life Curve

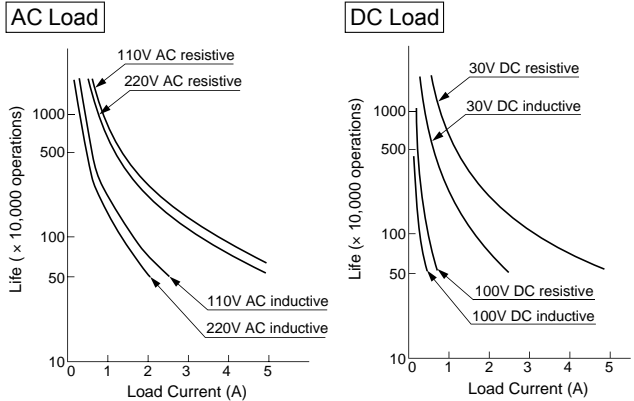

Continuous Load Current vs. Operating Temperature Curve (Basic, With Check Button, and Top Bracket Mounting)

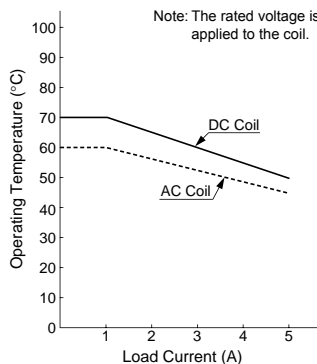

RM Series Miniature Relays

Internal Connection (Bottom View)

Basic (-U, UT)

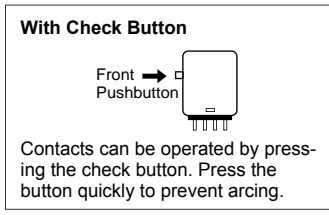
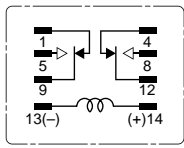

With Indicator (-UL)

Below 24V AC/DC

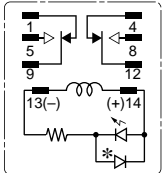

24V AC/DC and over

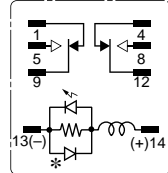

When the coil is energized, the indicator goes on.
* The LED protection diode is not contained in DPDT relays for below 100V DC.

With Indicator and Diode (-UD, -ULD)

Below 24V DC

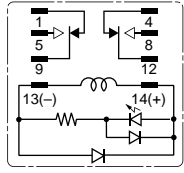

24V DC and over

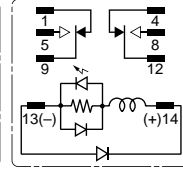

This type contains an operation indicator and a surge absorber, and has the same height as the basic type.

Dimensions

Plug-in (Solder Terminal)

RM2S-U/RM2S-UL
RM2S-UD/RM2S-ULD



(Photo: RM2S-U)

Total length from the panel surface including relay socket.
SM2S-05A: 61.5 (63.5) max., SM2S-51: 39.6 (41.6) max.

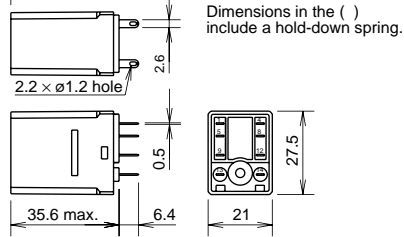

Applicable Socket and Hold-down Spring

Mounting Style	Socket		Hold-down Spring
	Part No.		
DIN Rail Mount Socket	SM2S-05*		SFA-101 SFA-202 SFA-502
Panel Mount Socket	SM2S-51		SY4S-51F1 (SY4S-02F1)
PC Board Mount Socket	SM2S-61		SFA-301 SFA-302

Note: (SY4S-02F1) is for the relay with check button.



PC Board Terminal

RM2V-U/RM2V-UL



(Photo: RM2V-U)

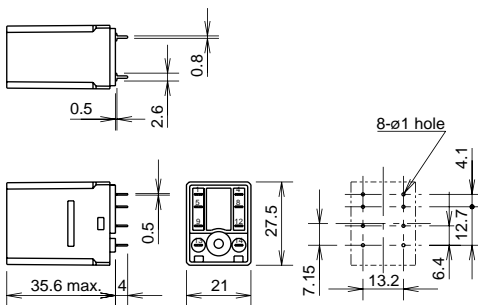

Top Bracket Mounting (Solder Terminal)

RM2S-UT

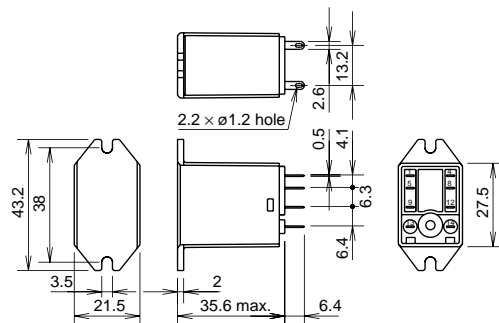





All dimensions in mm.

RH Series Power Relays

SPDT through 4PDT, 10A contacts Midget power relays

The RH series are miniature power relays with a large capacity. The RH relays feature 10A contact capacity as large as the RR series and the same size as IDEC's miniature relays. The compact size saves space.

Standard	Mark	Approval Organization / File No.
UL508		UL recognized, File No. E55996 No. E66043
CSA C22.2 No.14		CSA File No. LR35144
EN61810-1		TÜV SÜD
		EU Low Voltage Directive

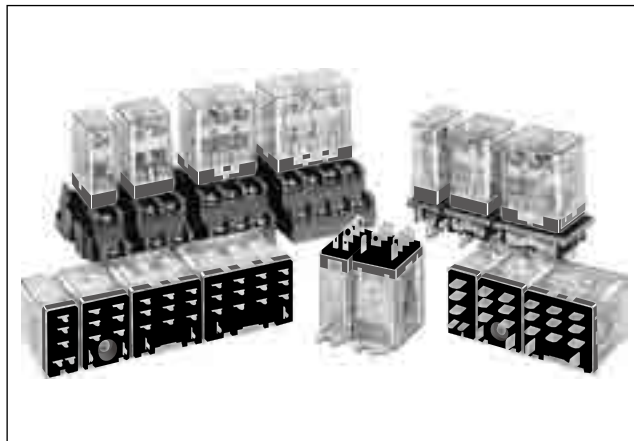

Termination	Style	SPDT		DPDT		
		Part No.	Coil Voltage Code *	Part No.	Coil Voltage Code *	
Plug-in Terminal	Basic	RH1B-U* RH1B-UW*	AC6, AC12, AC24, AC50, AC100, AC110, AC115, AC120, AC200, AC220, AC230, AC240 DC6, DC12, DC24, DC48, DC100, DC110	RH2B-U* RH2B-UW*	AC6, AC12, AC24, AC50, AC100-110, AC110-120, AC200-220, AC220-240 DC6, DC12, DC24, DC48, DC100-110	
	With Indicator	RH1B-UL* RH1B-ULW*		RH2B-UL* RH2B-ULW*		
	With Check Button	—		RH2B-UC*		
	With Indicator and Check Button	—		RH2B-ULC*		
	Top Bracket Mounting	RH1B-UT* RH1B-UTW*		RH2B-UT* RH2B-UTW*		
	With Diode (DC coil only)	RH1B-UD* RH1B-UDW*		DC6, DC12, DC24, DC48, DC100, DC110		RH2B-UD* RH2B-UDW*
	With Indicator and Diode (DC coil only)	RH1B-ULD* RH1B-ULDW*		—		RH2B-ULD* RH2B-ULDW*
PC Board Terminal	Basic	RH1V2-U* RH1V2-UW*	AC6, AC12, AC24, AC50, AC100, AC110, AC115, AC120, AC200, AC220, AC230, AC240 DC6, DC12, DC24, DC48, DC100, DC110	RH2V2-U* RH2V2-UW*	AC6, AC12, AC24, AC50, AC100-110, AC110-120, AC200-220, AC220-240 DC6, DC12, DC24, DC48, DC100-110	
	With Indicator	—	—	RH2V2-UL* RH2V2-ULW*		
	With Diode (DC coil only)	RH1V2-UD* RH1V2-UDW*	DC6, DC12, DC24, DC48, DC100	RH2V2-UD* RH2V2-UDW*	DC6, DC12, DC24, DC48, DC100-110	

• Part number ending with W is cadmium free.

Part No. Development

When ordering, specify the Part No. and coil voltage code.

(Example) **RH2B-U** **AC100-110**
 Part No. Coil Voltage Code

RH Series Power Relays

Termination	Style	3PDT				4PDT			
		Part No.		Coil Voltage Code *		Part No.		Coil Voltage Code *	
Plug-in Terminal	Basic	RH3B-U* RH3B-UW*		AC6, AC12, AC24, AC50, AC100, AC110, AC115, AC120, AC200, AC220, AC230, AC240 DC6, DC12, DC24, DC48, DC100, DC110	RH4B-U* RH4B-UW*		AC6, AC12, AC24, AC50, AC100, AC110, AC115, AC120, AC200, AC220, AC230, AC240 DC6, DC12, DC24, DC48, DC100, DC110		
	With Indicator	RH3B-UL*			RH4B-UL* RH4B-ULW*				
	With Check Button	RH3B-UC*			RH4B-UC*				
	With Indicator and Check Button	RH3B-ULC*			RH4B-ULC*				
	Top Bracket Mounting	RH3B-UT* RH3B-UTW*			RH4B-UT* RH4B-UTW*				
	With Diode (DC coil only)	RH3B-D* (Note) RH3B-DW* (Note)			DC6, DC12, DC24, DC48, DC100, DC110	RH4B-UD* RH4B-UDW*			
	With Indicator and Diode (DC coil only)	RH3B-LD* (Note) RH3B-LDW* (Note)		RH4B-ULD* RH4B-ULDW*					
PC Board Terminal	Basic	RH3V2-U* RH3V2-UW*		AC6, AC12, AC24, AC50, AC100, AC110, AC115, AC120, AC200, AC220, AC230, AC240 DC6, DC12, DC24, DC48, DC100, DC110	RH4V2-U* RH4V2-UW*		AC6, AC12, AC24, AC50, AC100, AC110, AC115, AC120, AC200, AC220, AC230, AC240 DC6, DC12, DC24, DC48, DC100, DC110		
	With Indicator	RH3V2-UL* RH3V2-ULW*			RH4V2-UL* RH4V2-ULW*				
	With Diode (DC coil only)	RH3V2-D* (Note) RH3V2-DW* (Note)		DC6, DC12, DC24, DC48, DC100, DC110	RH4V2-UD* RH4V2-UDW*				
	With Indicator and Diode (DC coil only)	RH3V2-LD* (Note) RH3V2-LDW* (Note)			RH4V2-ULD* RH4V2-ULDW*				

Note: No standard approval.
 • Part number ending with W is cadmium free.

Part No. Development
 When ordering, specify the Part No. and coil voltage code.

(Example) **RH3B-U** **AC110**

Part No. Coil Voltage Code

Coil Ratings

	Rated Voltage (V)				Rated Current (mA) ±15% at 20°C								Coil Resistance (Ω) ±10% at 20°C				Operation Characteristics (against rated values at 20°C)		
	SPDT	DPDT	3PDT	4PDT	50Hz				60Hz				SPDT	DPDT	3PDT	4PDT	Max. Continuous Applied Voltage	Min. Pickup Voltage	Dropout Voltage
					SPDT	DPDT	3PDT	4PDT	SPDT	DPDT	3PDT	4PDT							
AC (50/60Hz)	6	6	6	6	170	240	330	387	150	200	280	330	18.8	9.4	6.4	5.4	110%	80% maximum	30% minimum
	12	12	12	12	86	121	165	196	75	100	140	165	76.8	39.3	25.3	21.2			
	24	24	24	24	42	60.5	81	98	37	50	70	83	300	153	103	84.5			
	50	50	50	50	20.5	28.9	39.5	47	18	24	34	40	1,280	680	460	340			
	100	100-110	100	100	10.5	10.3-11.8	20	23.5	9	9.1-10.0	17	20	5,220	3,360	1,940	1,560			
	110	—	110	110	9.6	—	18.1	21.6	8.4	—	15.5	18.2	6,950	—	2,200	1,800			
	115	110-120	115	115	8.9	9.4-10.8	17.1	20.8	7.8	8.0-9.2	14.8	17.5	7,210	4,290	2,620	1,910			
	120	—	120	120	8.6	—	16.4	19.5	7.5	—	14.2	16.5	8,100	—	2,770	2,220			
	200	200-220	200	200	5.6	5.1-5.9	9.8	11.8	4.9	4.3-5.0	8.5	10	21,442	13,690	8,140	6,360			
	220	—	220	220	4.7	—	8.8	10.7	4.1	—	7.7	9.1	25,892	—	10,800	7,360			
230	220-240	230	230	4.7	4.7-5.4	8.5	10.3	4.1	4.0-4.6	7.4	8.7	26,710	18,820	11,500	8,520				
240	—	240	240	4.9	—	8.2	9.8	4.3	—	7.1	8.3	26,710	—	12,100	9,120				
DC	SPDT	DPDT	3PDT	4PDT	SPDT	DPDT	3PDT	4PDT	SPDT	DPDT	3PDT	4PDT	110%	80% maximum	10% minimum				
	6	6	6	6	128	150	240	250	47	40	25	24							
	12	12	12	12	64	75	120	125	188	160	100	96							
	24	24	24	24	32	36.9	60	62	750	650	400	388							
	48	48	48	48	18	18.5	30	31	2,660	2,600	1,600	1,550							
	100	100-110	100	100	10	8.2-9.0	14.5	15	10,000	12,250	6,900	6,670							
110	—	110	110	8	—	12.8	15	13,800	—	8,600	7,340								

RH Series Power Relays

Contact Ratings

Maximum Contact Capacity						
Contact	Continuous Current	Allowable Contact Power		Rated Load		
		Resistive Load	Inductive Load	Voltage (V)	Res. Load	Ind. Load
SPDT	10A	1540VA AC 300W DC	990VA AC 210W DC	110 AC	10A	7A
				220 AC	7A	4.5A
				30 DC	10A	7A
DPDT 3PDT 4PDT	10A	1650VA AC 300W DC	1100VA AC 225W DC	110 AC	10A	7.5A
				220 AC	7.5A	5A
				30 DC	10A	7.5A

Note: Inductive load for the rated load — $\cos \phi = 0.3$, L/R = 7 ms

UL Ratings (silver cadmium oxide)

Voltage	Resistive			General use			Horse Power Rating		
	RH1 RH2	RH3	RH4	RH1 RH2	RH3	RH4	RH1 RH2	RH3	RH4
240V AC	10A	7.5A	7.5A	7A	6.5A	5A	1/3 HP	1/3 HP	—
120V AC	—	10A	10A	—	7.5A	7.5A	1/6 HP	1/6 HP	—
30V DC	10A	10A	—	7A	—	—	—	—	—
28V DC	—	—	10A	—	—	—	—	—	—

UL Ratings (cadmium free)

Voltage	Resistive			General use			Horse Power Rating		
	RH1 RH2	RH3	RH4	RH1 RH2	RH3	RH4	RH1 RH2	RH3	RH4
240V AC	10A	10A	10A	10A	10A	10A	1/3 HP	1/3 HP	—
120V AC	—	—	—	—	—	—	1/6 HP	1/6 HP	—
30V DC	10A	10A	10A	7A	—	—	—	—	—

CSA Ratings (Silver cadmium oxide/cadmium free)

Voltage	Resistive				General use				Horse Power Rating
	RH1	RH2	RH3	RH4	RH1	RH2	RH3	RH4	
240V AC	10A	10A	10A	10A	7A	7A	7A	5A	1/3 HP
120V AC	10A	10A	10A	10A	7.5A	7.5A	—	7.5A	1/6 HP
30V DC	10A	10A	10A	10A	7A	7.5A	—	—	—

TÜV Ratings (silver cadmium oxide/cadmium free)

Voltage	RH1	RH2	RH3	RH4
240V AC	10A	10A	7.5A	7.5A
30V DC	10A	10A	10A	10A

AC: $\cos \phi = 1.0$, DC: L/R = 0 ms

Specifications

Contact Material	Silver cadmium oxide/cadmium free (Ag-alloy)	
Contact Resistance *1	50 mΩ maximum	
Minimum Applicable Load	24V DC, 30 mA; 5V DC, 100 mA (reference value)	
Operate Time *2	SPDT/DPDT	20 ms maximum
	3PDT/4PDT	25 ms maximum
Release Time *2	SPDT/DPDT	20 ms maximum
	3PDT/4PDT	25 ms maximum
Power Consumption (approx.)	SPDT	AC: 1.1 VA (50 Hz), 1 VA (60 Hz), DC: 0.8W
	DPDT	AC: 1.4 VA (50 Hz), 1.2 VA (60 Hz), DC: 0.9W
	3PDT	AC: 2 VA (50 Hz), 1.7 VA (60 Hz), DC: 1.5W
	4PDT	AC: 2.5 VA (50 Hz), 2 VA (60 Hz), DC: 1.5W
Insulation Resistance	100 MΩ minimum (500V DC megger)	
Dielectric Strength	SPDT	Between live and dead parts: 2000V AC, 1 minute *3 Between contact and coil: 2000V AC, 1 minute Between contacts of the same pole: 1000V AC, 1 minute
	DPDT/3PDT/4PDT	Between live and dead parts: 2000V AC, 1 minute Between contact and coil: 2000V AC, 1 minute Between contacts of different poles: 2000V AC, 1 minute Between contacts of the same pole: 1000V AC, 1 minute
Operating Frequency	Electrical: 1,800 operations/h maximum Mechanical: 18,000 operations/h maximum	
Vibration Resistance	Damage limits: 10 to 55 Hz, amplitude 0.5 mm Operating extremes: 10 to 55 Hz, amplitude 0.5 mm	
Shock Resistance	Damage limits: 1,000 m/s ² Operating extremes: 200 m/s ² (SPDT, DPDT) 100 m/s ² (3PDT, 4PDT)	
Mechanical Life	50,000,000 operations minimum	
Electrical Life	DPDT	Silver cadmium oxide contact: 500,000 operations minimum (110V AC, 10A) Cadmium free (Ag-alloy) contact: 300,000 operations minimum
	SPDT/3PDT/4PDT	200,000 operations minimum (110V AC, 10A)
Operating Temperature *4	SPDT	-25 to +50°C (no freezing)
	DPDT/3PDT/4PDT	-25 to +40°C (no freezing)
Operating Humidity	45 to 85% RH (no condensation)	
Storage Temperature	-55 to +70°C (no freezing)	
Storage Humidity	45 to 85% RH (no condensation)	
Weight (approx.)	SPDT: 24g, DPDT: 37g, 3PDT: 50g, 4PDT: 74g	

Note: Above values are initial values.

- *1: Measured using 5V DC, 1A voltage drop method
- *2: Measured at the rated voltage (at 20°C), excluding contact bouncing
Release time of relays with diode: 40 ms maximum
- *3: Relays with indicator or diode: 1000V AC, 1 minute
- *4: For use under different temperature conditions, refer to Continuous Load Current vs. Operating Temperature Curve. The operating temperature range of relays with indicator or diode is -25 to +40°C.

RH Series Power Relays

Internal Connection (Bottom View)

Basic

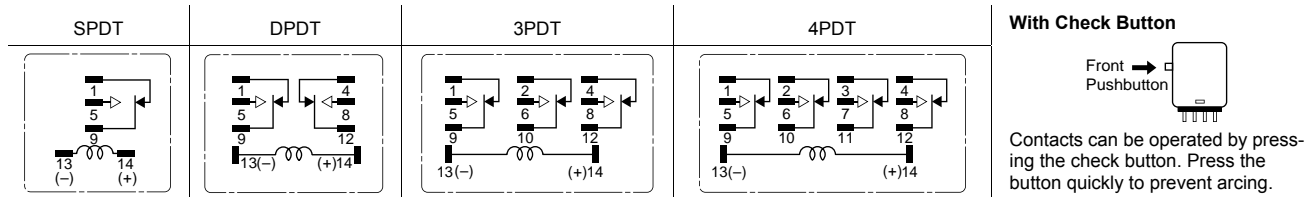

With Indicator (-L)

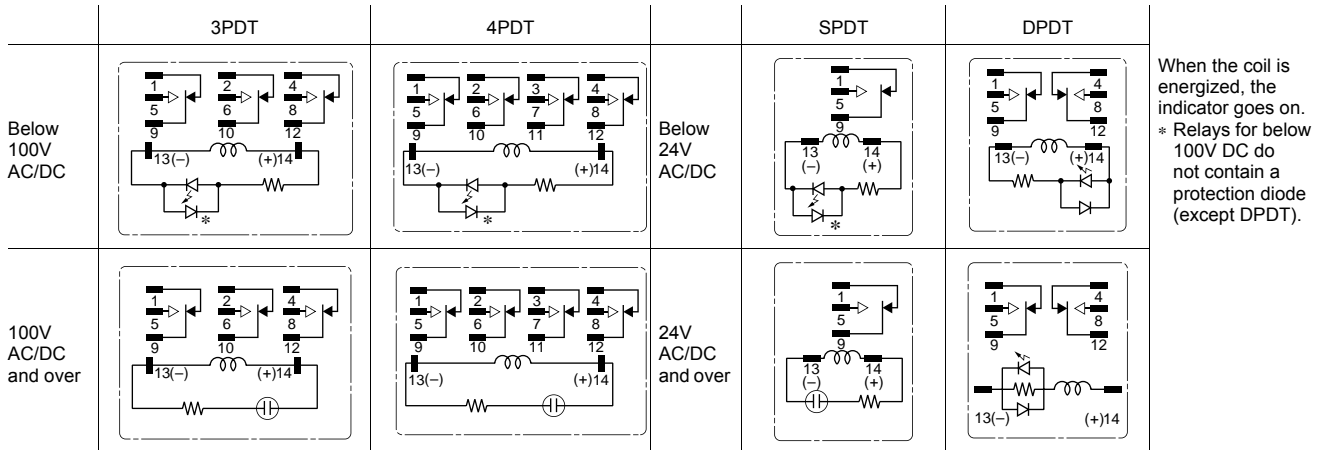

With Diode (-D)

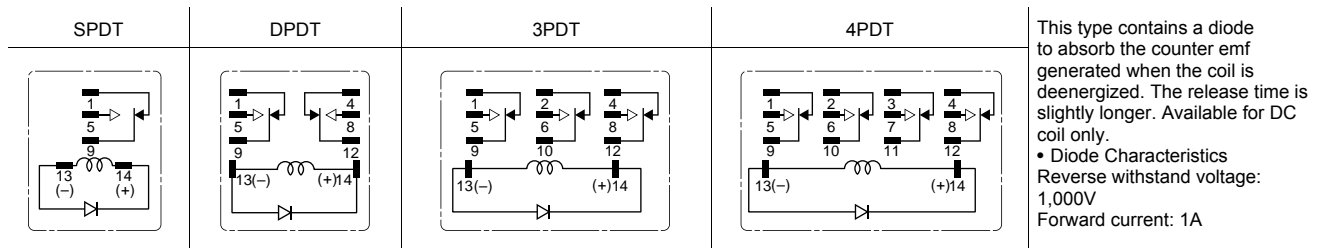

With Indicator and Diode (-LD)

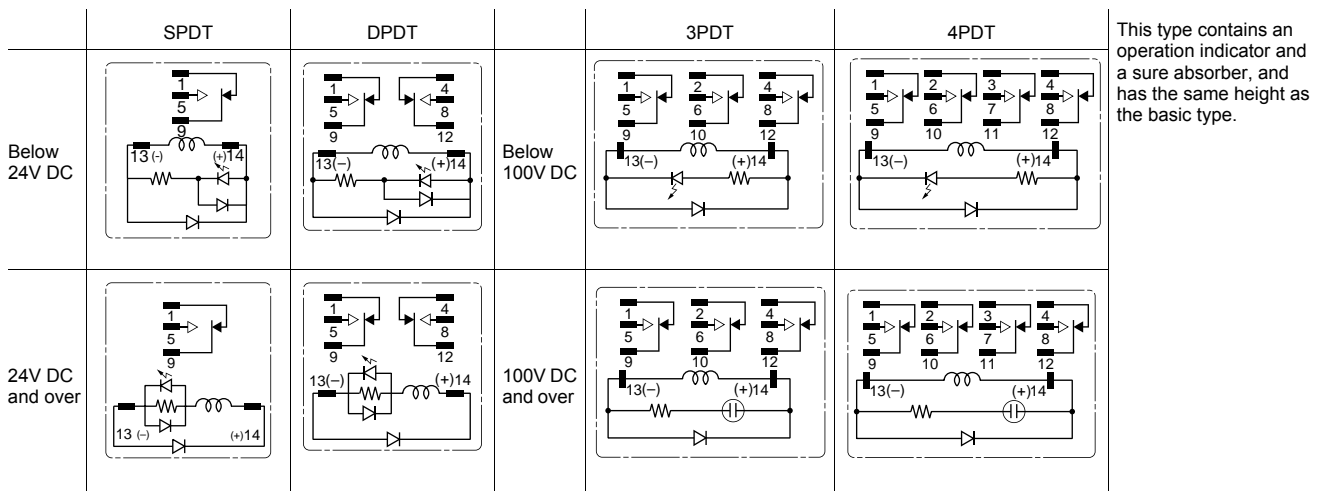

RH Series Power Relays

Characteristics (Reference Data)

Maximum Switching Capacity

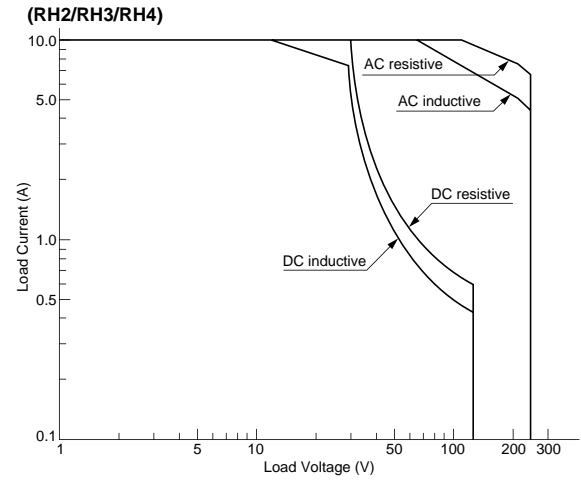
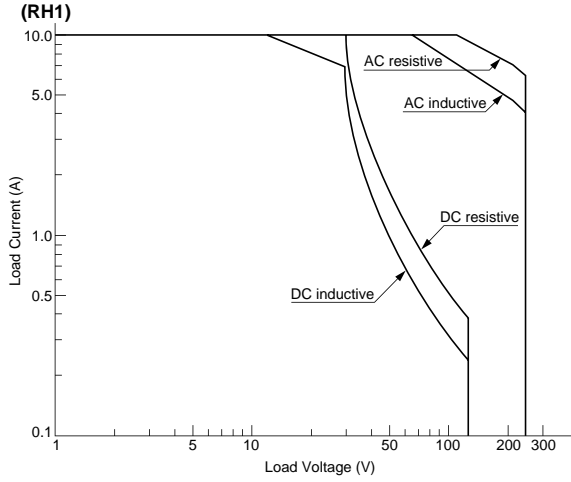

Electrical Life Curve

AC Load

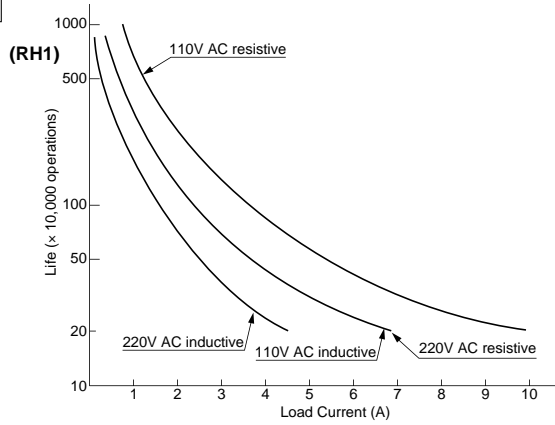

DC Load

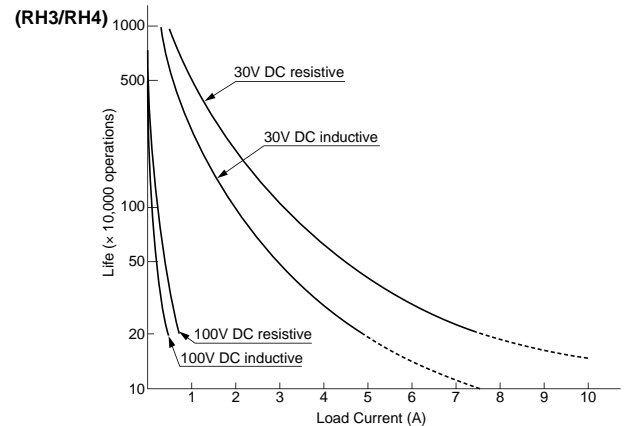
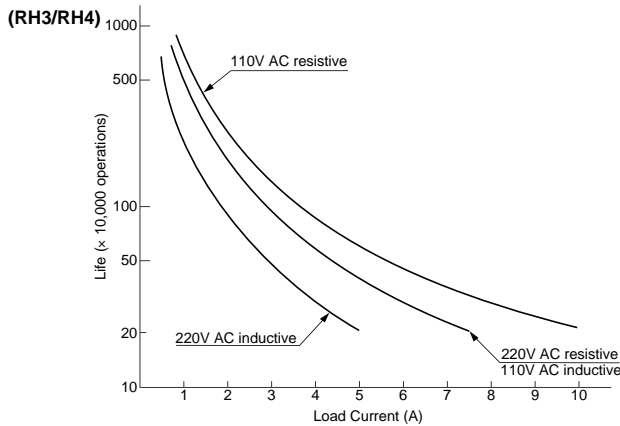
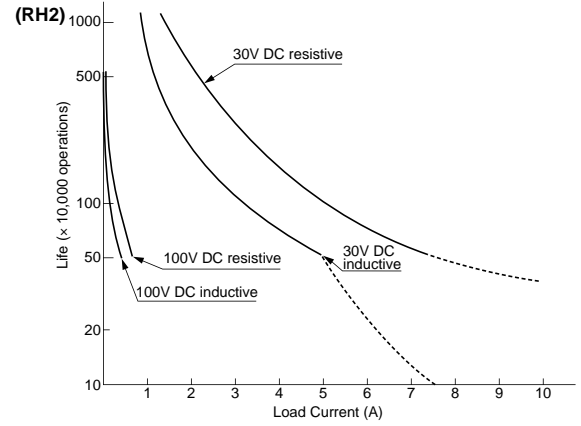
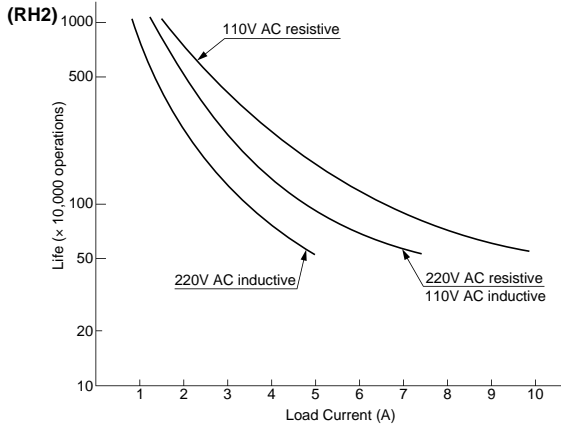
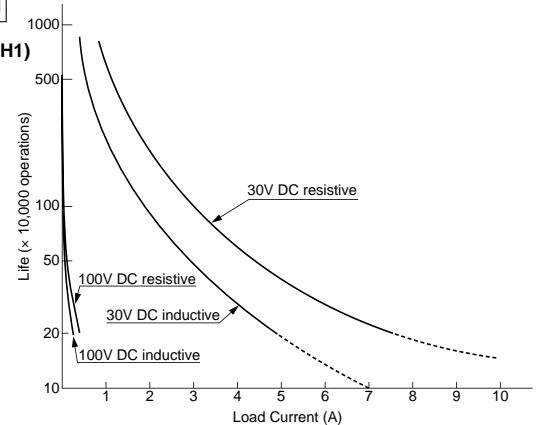

RH Series Power Relays

Continuous Load Current vs. Operating Temperature Curve (Basic, With Check Button, and Top Bracket Mounting)

(RH1)

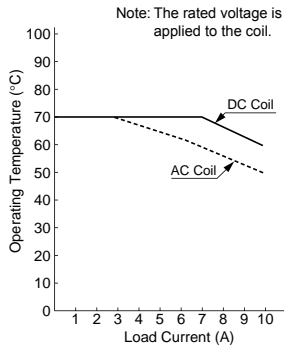

(RH2)

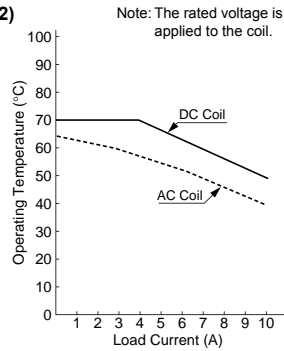

(RH3/RH4)

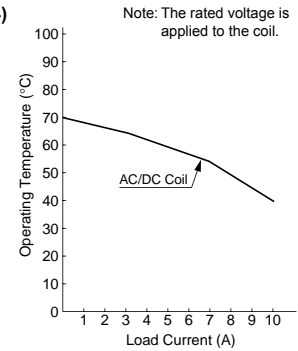

Dimensions

SPDT Plug-in Terminal
RH1B-U/RH1B-UL/RH1B-UD/ULD

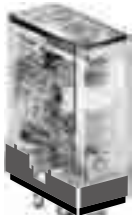

(Photo: RH1B-U)

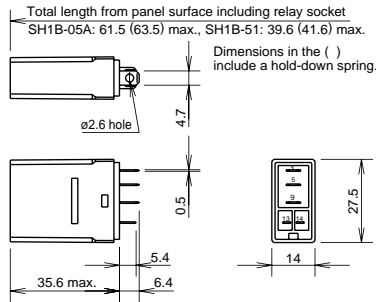

Applicable Socket and Hold-down Spring

Mounting Style	Socket		Hold-down Spring
	Part No.		
DIN Rail Mount Socket	SH1B-05*		SFA-101 SFA-202
Panel Mount Socket	SH1B-51		SY4S-51F1 SFA-301
PC Board Mount Socket	SH1B-62		SFA-302

DPDT Plug-in Terminal
RH2B-U/RH2B-UL/RH2B-UD/RH2B-ULD



(Photo: RH2B-U)

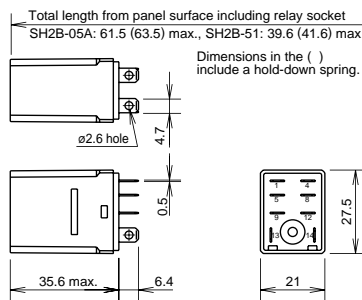

Applicable Socket and Hold-down Spring

Mounting Style	Socket		Hold-down Spring
	Part No.		
DIN Rail Mount Socket	SH2B-05* (Note)		SFA-202 SFA-101
Panel Mount Socket	SH2B-51		SY4S-51F1 SFA-302(Note) SFA-301(Note) (SY4S-02F1)
PC Board Mount Socket	SH2B-62		

Note: Not applicable with SH2B-62.
• (SY4S-02F1) is for the relay with check button.

3PDT Plug-in Terminal
RH3B-U/RH3B-UL/RH3B-D/RH3B-LD



(Photo: RH3B-U)

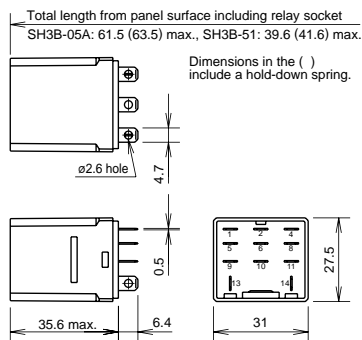

Applicable Socket and Hold-down Spring

Mounting Style	Socket		Hold-down Spring
	Part No.		
DIN Rail Mount Socket	SH3B-05*		SFA-101 SFA-202
Panel Mount Socket	SH3B-51		SY4S-51F1 SFA-301
PC Board Mount Socket	SH3B-62		SFA-302 (SH3B-05F1)

• (SH3B-05F1) is for the relay with check button.

4PDT Plug-in Terminal
RH4B-U/RH4B-UL/RH4B-UD/RH4B-ULD



(Photo: RH4B-U)

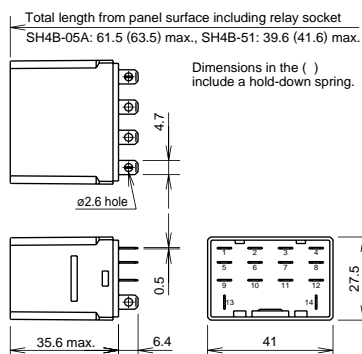

Applicable Socket and Hold-down Spring

Mounting Style	Socket		Hold-down Spring
	Part No.		
DIN Rail Mount Socket	SH4B-05*		SFA-101 SFA-202
Panel Mount Socket	SH4B-51		SY4S-51F1 (Note) SFA-301
PC Board Mount Socket	SH4B-62		SFA-302 (SH4B-02F1)

Note: Use two SY4S-51F1 hold-down springs for the SH4B-51 socket.
• (SH4B-02F1) is for the relay with check button.

RH Series Power Relays

SPDT Plug-in Terminal (Top Bracket Mounting)

RH1B-UT

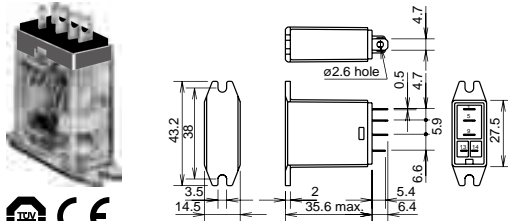

DPDT Plug-in Terminal (Top Bracket Mounting)

RH2B-UT

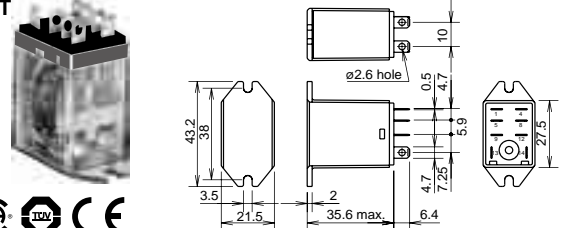

3PDT Plug-in Terminal (Top Bracket Mounting)

RH3B-UT

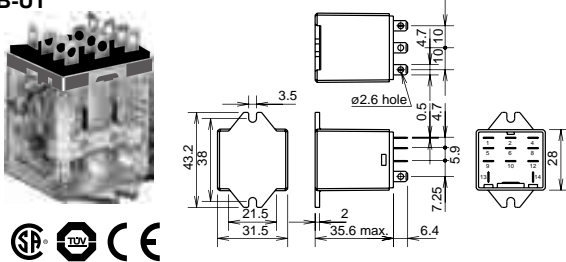

4PDT Plug-in Terminal (Top Bracket Mounting)

RH4B-UT

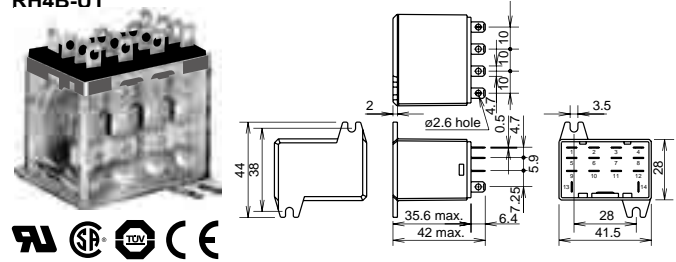
SPDT PC Board Terminal
RH1V2-U/RH1V2-UD

(Photo: RH1V2-U)

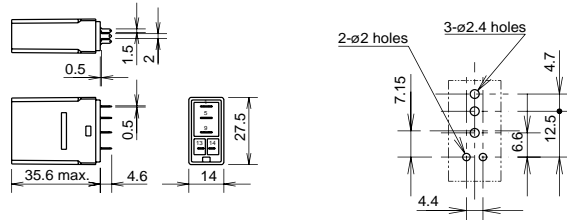
DPDT PC Board Terminal
RH2V2-U/RH2V2-UL/
RH2V2-UD

(Photo: RH2V2-U)

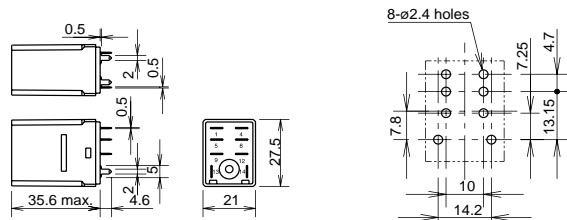

(RH2V2-U)

3PDT PC Board Terminal
RH3V2-U/RH3V2-UL/
RH3V2-D

(Photo: RH3V2-U)

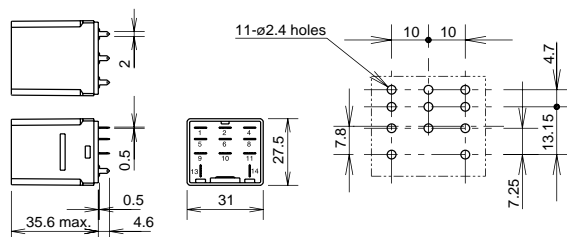
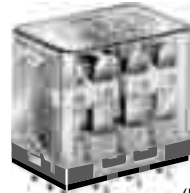

(RH3V2-U)

4PDT PC Board Terminal
RH4V2-U/RH4V2-UL/
RH4V2-UD

(Photo: RH4V2-U)



(RH4V2-U)

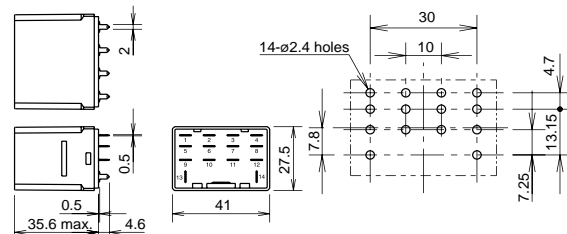

All dimensions in mm.

RR series Power Relays

Heavy-duty power relays Large capacity 10A — 1, 2, and 3 poles

- Available in pin and blade terminal styles.
- Options include an indicator, check button for test operation, and side flange.
- DIN rail, surface, and panel mount sockets are available for a wide variety of mounting applications.

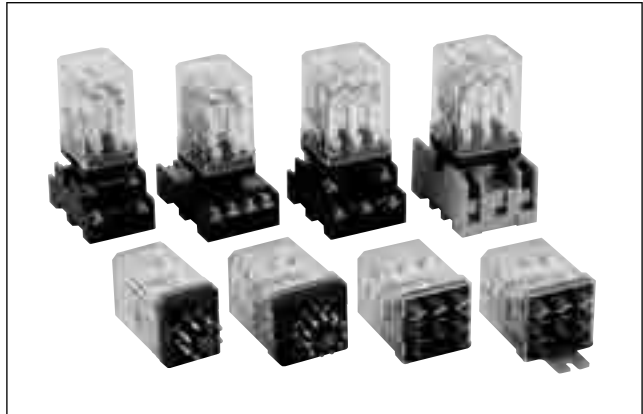

Termination	Style	Part No.				Coil Voltage Code *
		SPDT	DPDT	3PDT (Note)		
Pin Terminal	Basic	—	RR2P-U* ★	RR3P-U* ★	RR3PA-U* ★	AC6, AC12, AC24, AC50, AC100, AC110, AC115, AC120, AC200, AC220, AC230, AC240, DC6, DC12, DC24, DC48, DC110
	With Indicator	—	RR2P-UL* ★	RR3P-UL* ★	RR3PA-UL* ★	
	With Check Button	—	RR2P-UC* ★	RR3P-UC* ★	RR3PA-UC* ★	
	With Indicator and Check Button	—	RR2P-ULC* ★	RR3P-ULC* ★	RR3PA-ULC* ★	
Blade Terminal	Basic	RR1BA-U*	RR2BA-U*	RR3B-U*	—	
	With Indicator	RR1BA-UL*	RR2BA-UL*	RR3B-UL*	—	
	With Check Button	RR1BA-UC*	RR2BA-UC*	RR3B-UC*	—	
	With Indicator and Check Button	RR1BA-ULC*	RR2BA-ULC*	RR3B-ULC*	—	
	Side Flange	RR1BA-US*	RR2BA-US*	RR3B-US*	—	

Note:
Both RR3P and RR3PA are 3PDT relays and have different terminal arrangements. See Internal Connection on page 50. Part numbers marked with ★ in the table above are UL-recognized, CSA-certified, and TÜV-approved. Others are UL-recognized and CSA-certified.

Part No. Development

When ordering, specify the Part No. and coil voltage code.

(Example) **RR3P-U** **AC110**
 Part No. Coil Voltage Code

Coil Ratings

Rated Voltage (V)	Rated Current (mA) ±15% at 20°C		Coil Resistance (Ω) ±10% at 20°C	Operation Characteristics (against rated values at 20°C)		
	50Hz	60Hz		Max. Continuous Applied Voltage	Minimum Pickup Voltage	Dropout Voltage
AC (50/60Hz)	6	490	420	110%	80% maximum	30% minimum
	12	245	210			
	24	121	105			
	50	58	50			
	100	29	25			
	110	27	23			
	115	25	21.5			
	120	24	20.5			
	200	14.5	12.5			
	220	13.3	11.5			
	230	12.7	11			
240	12.1	10.5				
DC	6	240	25	110%	80% maximum	15% minimum
	12	120	100			
	24	60	400			
	48	30	1,600			
	110	13	8,460			

RR Series Power Relays

Contact Ratings

Maximum Contact Capacity					
Continuous Current	Allowable Contact Power		Rated Load		
	Resistive Load	Inductive Load	Voltage	Resistive Load	Inductive Load
10A	1650VAAC 300W DC	1100VAAC 150W DC	110V AC	10A	7.5A
			220V AC	7.5A	5A
			30V DC	10A	5A

Note: Inductive load for the rated load — $\cos \phi = 0.3$, L/R = 7 ms

UL Ratings

Voltage	Resistive	General use	Horse Power Rating
240V AC	10A	7A	1/3 HP
120V AC	10A	7.5A	1/4 HP
30V DC	10A	7A	—

CSA Ratings

Voltage	Resistive	General use
240V AC	10A	7A
120V AC	10A	7.5A
100V DC	—	0.5A
30V DC	10A	7.5A

TÜV Ratings

240V AC	10A
30V DC	10A

AC: $\cos \phi = 1.0$, DC: L/R = 0 ms

Specifications

Contact Material	Silver	
Contact Resistance	*1	30 m Ω maximum
Minimum Applicable Load	1V DC, 10 mA (reference value)	
Operate Time	*2	25 ms maximum
Release Time	*2	25 ms maximum
Power Consumption (approx.)	AC: 3 VA (50 Hz), 2.5 VA (60 Hz) DC: 1.5W	
Insulation Resistance	100 M Ω minimum (500V DC megger)	
Dielectric Strength	Pin Terminal	Between live and dead parts: 1500V AC, 1 minute Between contact and coil: 1500V AC, 1 minute Between contacts of different poles: 1500V AC, 1 minute Between contacts of the same pole: 1000V AC, 1 minute
	Blade Terminal	Between live and dead parts: 2000V AC, 1 minute Between contact and coil: 2000V AC, 1 minute Between contacts of different poles: 2000V AC, 1 minute Between contacts of the same pole: 1000V AC, 1 minute
Operating Frequency	Electrical: 1800 operations/h maximum Mechanical: 18,000 operations/h maximum	
Vibration Resistance	Damage limits: 10 to 55 Hz, amplitude 0.5 mm Operating extremes: 10 to 55 Hz, amplitude 0.5 mm	
Shock Resistance	Damage limits: 1000 m/s ² Operating extremes: 100 m/s ²	
Mechanical Life	10,000,000 operations	
Electrical Life	200,000 operations (220V AC, 5A)	
Operating Temperature	*3	-25 to +40°C (no freezing)
Operating Humidity	5 to 85% RH (no condensation)	
Weight (approx.) (Basic)	RR2P: 90g, RR3P/RR3PA: 96g, RR1BA/RR2BA/RR3B: 82g	

Note: Above values are initial values.

*1: Measured using 5V DC, 1A voltage drop method

*2: Measured at the rated voltage (at 20°C), excluding contact bouncing

*3: For use under different temperature conditions, refer to Continuous Load Current vs. Operating Temperature Curve.

RR Series Power Relays

Internal Connection (Bottom View)

Basic

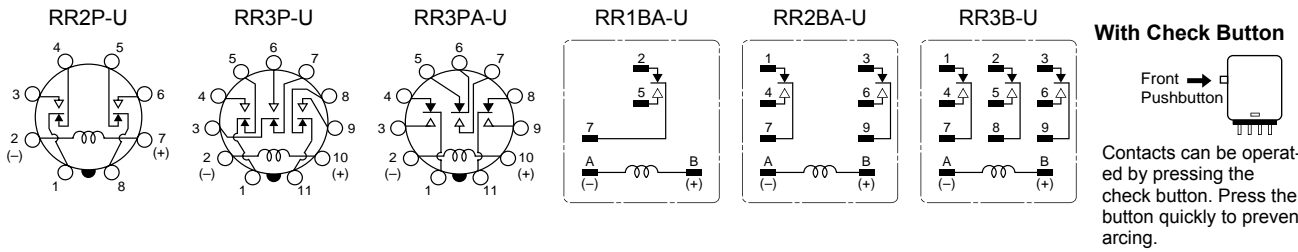

With Indicator (-UL)

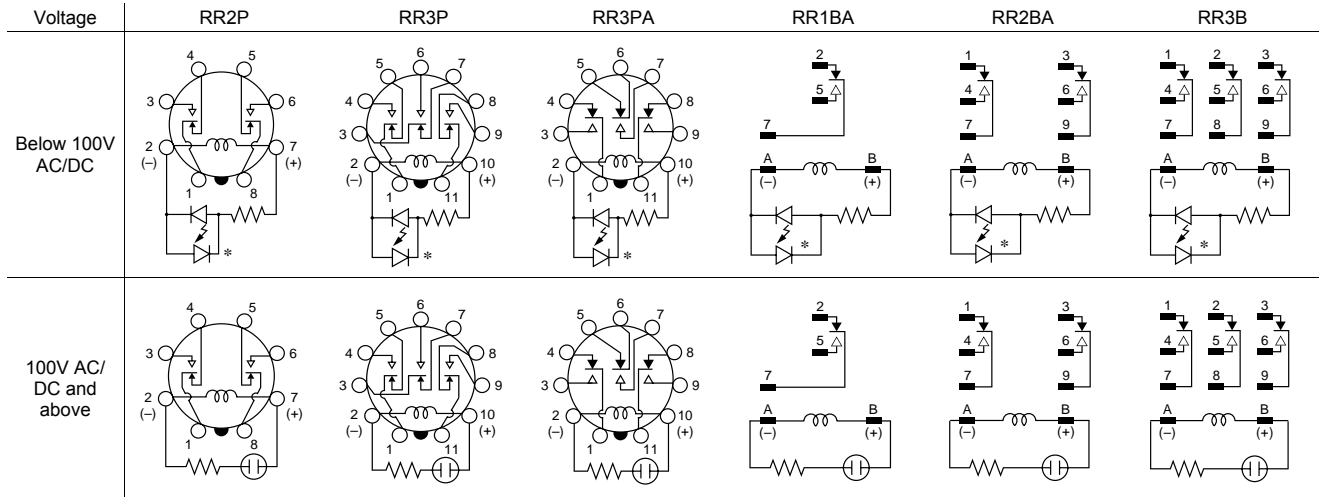

When the relay is energized, the indicator goes on.
* The LED protection diode is not contained in relays for below 100V DC.

Characteristics (Reference Data)

Maximum Switching Capacity

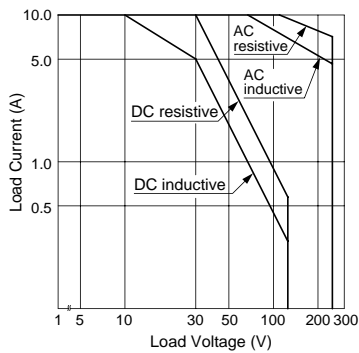

Continuous Load Current vs. Operating Temperature Curve (Basic, With Check Button, and Side Flange)

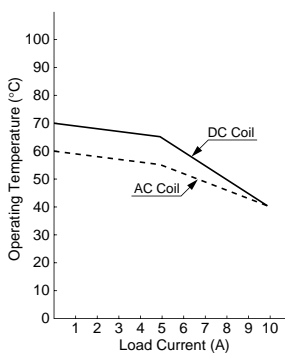

Electrical Life Curve

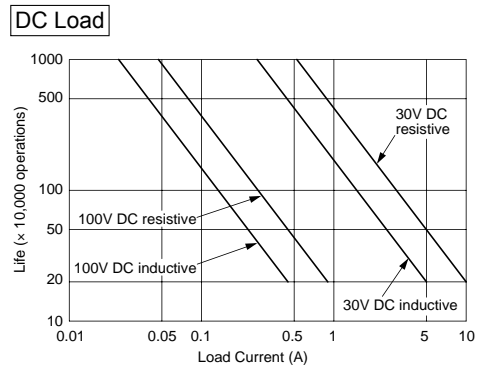
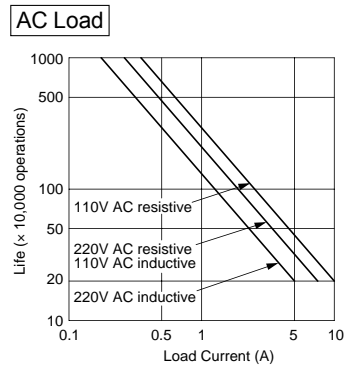

RR Series Power Relays

Dimensions

RR2P-U/RR2P-UL



(Photo: RR2P-U)

Total length from panel surface including relay socket
SR2P-05A: 84.5 (87.5) max., SR2P-511: 63 (68) max.

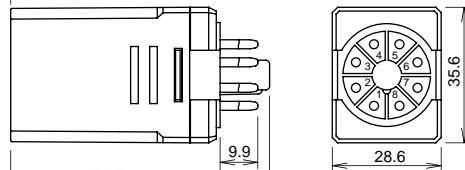

Dimensions in the () include a hold-down spring.



Applicable Socket and Hold-down Spring

Socket		Hold-down Spring
Mounting Style	Part No.	
DIN Rail Mount Socket	SR2P-05A SR2P-05C SR2P-06A	SR2B-02F1 SFA-202
Panel Mount Socket	w/Solder Terminals	SR2P-511
	w/Wire Wrap Terminals	SR2P-70
		SR3P-01F1

RR3P-U/RR3P-UL/ RR3PA-U/RR3PA-UL



(Photo: RR3P-U)

Total length from panel surface including relay socket
SR3P-05A: 84.5 (87.5) max., SR3P-511: 63 (68) max.

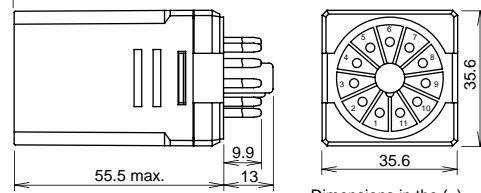

Dimensions in the () include a hold-down spring.



Applicable Socket and Hold-down Spring

Socket		Hold-down Spring
Mounting Style	Part No.	
DIN Rail Mount Socket	SR3P-05A SR3P-05C SR3P-06A	SR3B-02F1 SFA-202
Panel Mount Socket	w/Solder Terminals	SR3P-511
	w/Wire Wrap Terminals	SR3P-70
		SR3P-01F1

RR1BA-U/RR1BA-UL/ RR2BA-U/RR2BA-UL/ RR3B-U/RR3B-UL



(Photo: RR3B-U)

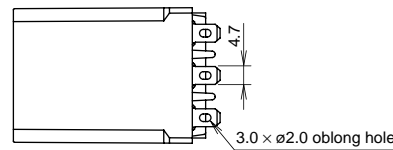

Total length from panel surface including relay socket
SR3B-05: 73 (76) max., SR3B-51: 56 (60) max.

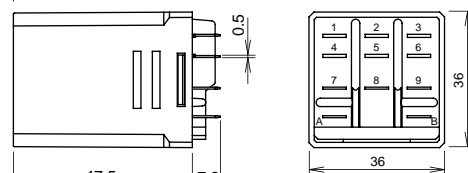

Dimensions in the () include a hold-down spring.



Applicable Socket and Hold-down Spring

Socket		Hold-down Spring
Mounting Style	Part No.	
DIN Rail Mount Socket	SR3B-05	SR3B-02F1 SFA-202
Panel Mount Socket	SR3B-51	SR3B-02F1

RR1BA-US RR2BA-US RR3B-US



(Photo: RR3B-US)

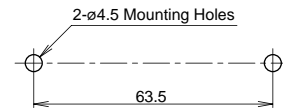
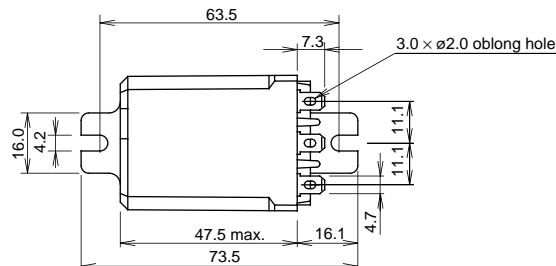





All dimensions in mm.

RV3T PC Board Terminal Relays

1NO contact, 5A. Space-saving (5mm-wide, 12.5mm-high) card relay.

- Highly sensitive 120mW
- SIL terminal enables easy patter design of PC Board terminal.
- Washable
- UL, CSA, TÜV compliant.

Applicable Standards	Mark	Certification Organization/ File No.
UL508		UL recognized File No. E68961
CSA C22.2 No. 14		CSA File No. 20479
EN61810-1		TÜV Rheinland
		EU Low Voltage Directive

Power Consumption	Contact	Coil Rated Voltage	Part No.
120mW	1NO	5V DC	RV3T-1G05
		12V DC	RV3T-1G12
		24V DC	RV3T-1G24
200mW	1NO	5V DC	RV3T-2G05
		12V DC	RV3T-2G12
		24V DC	RV3T-2G24

Coil Ratings

Power Consumption	Rated Voltage	Coil Resistance $\pm 10\%$ (at 20°C)	Rated Current $\pm 10\%$ (at 20°C)	Operating Characteristics (against rated values at 20°C)
120mW	5V DC	210Ω	24mA	Pickup voltage (initial value: 70% Dropout voltage (initial value): 5% Maximum continuous applied voltage: 190%
	12V DC	1,200Ω	10mA	
	24V DC	4,800Ω	5mA	
200mW	5V DC	125Ω	40mA	
	12V DC	720Ω	16.7mA	
	24V DC	2,880Ω	8.3mA	

Coil Ratings

Maximum Applied Voltage	250V AC, 125V DC
Rated Current	5A
Rated Contact Voltage/Current	AC250V 5A (resistive load) 24V DC 5A (resistive load)
Minimum Applicable Load (reference value)	DC0.1V, 100μA

Approved Ratings

UL and CSA Ratings

UL Ratings			CSA Ratings		
Contacts			Contacts		
Voltage	Resistive	Inductive	Voltage	Resistive	Inductive
240V AC	5A	—	240V AC	5A	—
120V AC	—	1A (Pilot duty)	120V AC	—	1A (Pilot duty) (10A inrush)
120V DC	0.5A	0.2A (Pilot duty)	120V DC	0.5A	0.2A (15ms)
30V DC	5A	2A (Pilot duty)	30V DC	5A	2A (15ms)

TÜV Ratings

Rated Contact Data	
Max. Rated Voltage	Max. Rated Current
AC 240V	5A
DC 120V	≤5A



Specifications

Conact Resistance *1	30 mΩ maximum
Operate Time *2	10 ms maximum
Release Time *2	5 ms maximum
Insulation Resistance	100 MΩ minimum (500V DC megger)
Dielectric Strength	Between contact and coil: 2000V AC, 1 minute
	Between contact gaps: 750V AC, 1 minute
Vibration Resistance	Damage limits
	Operating extremes
Shock Resistance	Damage limits
	Operating extremes
Operating Temperature	-40 to +70°C (no freezing)
Operating Humidity	45 to 85% RH (no condensation)
Storage Temperature	-40 to +70°C (no freezing)
Storage Humidity	45 to 85% RH (no condensation)
Life	Mechanical
	Electrical
Weight (approx.)	3g

Note: Above values are initial values.

*1: Measured using 5V DC, 1A voltage drop method

*2: Measured at the rated voltage (at 20°C)

Dimensions

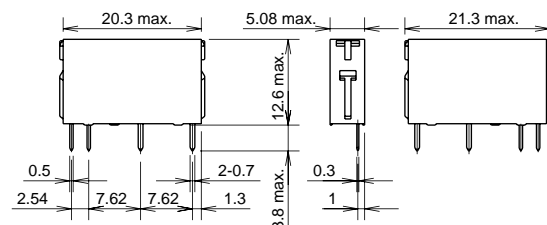

All dimensions in mm.

Internal Connection



Mounting Hole Layout (bottom view)

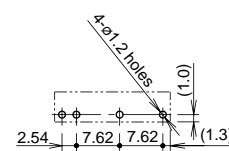

RV3T PC Board Terminal Relays

Electrical Life Curve

AC Load

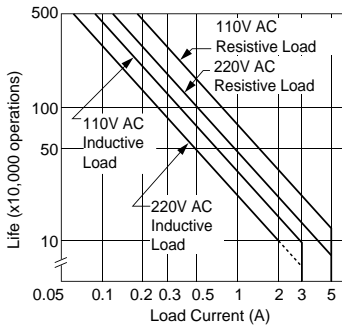

DC Load

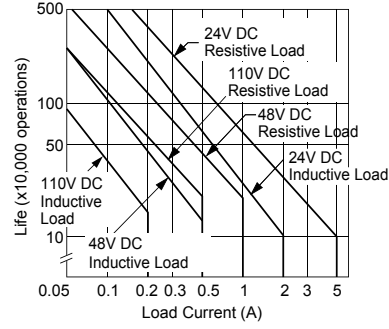

Maximum Switching Current

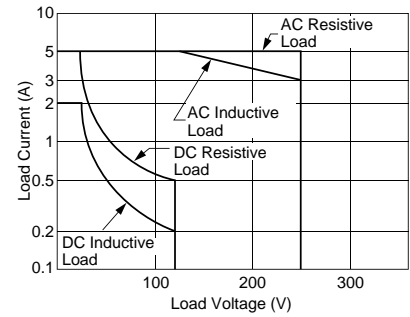

Coil Voltage Range

Single mounting

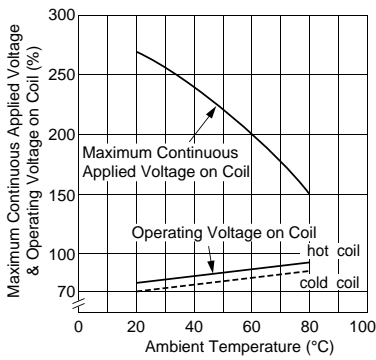

Collective Mounting

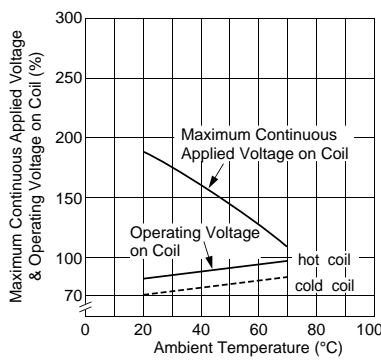

RF1V Force Guided Relays

Compact and EN compliant RF1V force guided relays.

- Force guided contact mechanism (EN50205 Type A TÜV approved)
- Contact configuration
4-pole (2NO-2NC, 3NO-1NC)
6-pole (4NO-2NC, 5NO-1NC, 3NO-3NC)
- Built-in LED indicator available.
- Fast response time (8 ms maximum).
- High shock resistance (200 m/s² minimum)
- Finger-safe DIN rail mount socket and PC board mount socket.

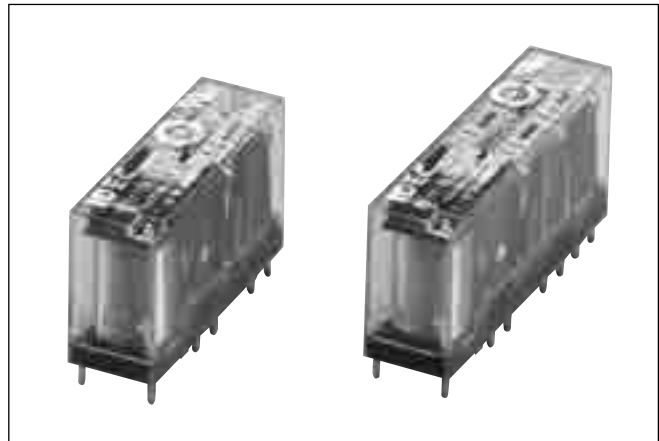

Applicable Standard	Marking	Certification Organization / File No.
UL508		UL recognized File No. E55996
CSA C22.2 No.14		CSA File No. 253350
EN50205 EN61810-1		TÜV SÜD

Force Guided Relays

Contact		Rated Coil Voltage	Without LED Indicator	With LED Indicator
			Part No.	Part No.
4-pole	2NO-2NC	12V DC	RF1V-2A2B-D12	RF1V-2A2BL-D12
		24V DC	RF1V-2A2B-D24	RF1V-2A2BL-D24
		48V DC	RF1V-2A2B-D48	RF1V-2A2BL-D48
	3NO-1NC	12V DC	RF1V-3A1B-D12	RF1V-3A1BL-D12
		24V DC	RF1V-3A1B-D24	RF1V-3A1BL-D24
		48V DC	RF1V-3A1B-D48	RF1V-3A1BL-D48
6-pole	4NO-2NC	12V DC	RF1V-4A2B-D12	RF1V-4A2BL-D12
		24V DC	RF1V-4A2B-D24	RF1V-4A2BL-D24
		48V DC	RF1V-4A2B-D48	RF1V-4A2BL-D48
	5NO-1NC	12V DC	RF1V-5A1B-D12	RF1V-5A1BL-D12
		24V DC	RF1V-5A1B-D24	RF1V-5A1BL-D24
		48V DC	RF1V-5A1B-D48	RF1V-5A1BL-D48
	3NO-3NC	12V DC	RF1V-3A3B-D12	RF1V-3A3BL-D12
		24V DC	RF1V-3A3B-D24	RF1V-3A3BL-D24
		48V DC	RF1V-3A3B-D48	RF1V-3A3BL-D48

Package quantity: 10

Coil Ratings

Contact		Rated Coil Voltage (V)	Rated Current (mA) ±10% (at 20°C) (Note 1)	Coil Resistance (Ω) ±10% (at 20°C)	Operating Characteristics (at 20°C)			Power Consumption
					Pickup Voltage (initial value)	Dropout Voltage (initial value)	Maximum Continuous Applied Voltage (Note 2)	
4-pole	2NO-2NC	12V DC	30	400	75% maximum	10% minimum	110%	Approx. 0.36W
		24V DC	15	1600				
		48V DC	7.5	6400				
	3NO-1NC	12V DC	30	400				
		24V DC	15	1600				
		48V DC	7.5	6400				
6-pole	4NO-2NC	12V DC	41.7	288				
		24V DC	20.8	1152				
		48V DC	10.4	4608				
	5NO-1NC	12V DC	41.7	288				
		24V DC	20.8	1152				
		48V DC	10.4	4608				
	3NO-3NC	12V DC	41.7	288				
		24V DC	20.8	1152				
		48V DC	10.4	4608				
								Approx. 0.5W

Note 1: For relays with LED indicator, the rated current increases by approx. 2 mA.

Note 2: Maximum continuous applied voltage is the maximum voltage that can be applied to relay coils.

RF1V Force Guided Relays

Specifications

Number of Poles		4-pole		6-pole	
Contact Configuration		2NO-2NC	3NO-1NC	4NO-2NC	5NO-1NC 3NO-3NC
Contact Resistance (initial value) (Note 1)		100 mΩ maximum			
Contact Material		AgSnO ₂ (Au flashed)			
Rated Load (resistive load)		6A 250V AC, 6A 30V DC			
Allowable Switching Power (resistive load)		1500 VA, 180W			
Allowable Switching Voltage		250V AC, 125V DC			
Allowable Switching Current		6A			
Minimum Applicable Load (Note 2)		5V DC, 1 mA (reference value)			
Power Consumption (approx.)		0.36W		0.5W	
Insulation Resistance		1000 MΩ minimum (500V DC megger, same measurement positions as the dielectric strength)			
Dielectric Strength	Between contact and coil	4000V AC, 1 minute			
	Between contacts of different poles	2500V AC, 1 minute Between contacts 7-8 and 9-10		2500V AC, 1 minute Between contacts 7-8 and 11-12 Between contacts 9-10 and 13-14 Between contacts 11-12 and 13-14	
		4000V AC, 1 min. Between contacts 3-4 and 5-6 Between contacts 3-4 and 7-8 Between contacts 5-6 and 9-10		4000V AC, 1 min. Between contacts 3-4 and 5-6 Between contacts 3-4 and 7-8 Between contacts 5-6 and 9-10 Between contacts 7-8 and 9-10	
	Between contacts of the same pole	1500V AC, 1 minute			
Operate Time (at 20°C)		20 ms maximum (at the rated coil voltage, excluding contact bounce time)			
Response Time (at 20°C) (Note 3)		8 ms maximum (at the rated coil voltage, excluding contact bounce time)			
Release Time (at 20°C)		20 ms maximum (at the rated coil voltage, excluding contact bounce time)			
Vibration Resistance	Operating Extremes	10 to 55 Hz, amplitude 0.75 mm			
	Damage Limits	10 to 55 Hz, amplitude 0.75 mm			
Shock Resistance	Operating Extremes (half sine-wave pulse: 11 ms)	200 m/s ² , when mounted on DIN rail mount socket: 150 m/s ²			
	Damage Limits (half sine-wave pulse: 6 ms)	1000 m/s ²			
Electrical Life		250V AC 6A resistive load: 100,000 operations minimum (operating frequency 1200 per hour) 30V DC 6A resistive load: 100,000 operations minimum (operating frequency 1200 per hour) 250V AC 1A resistive load: 500,000 operations minimum (operating frequency 1800 per hour) 30V DC 1A resistive load: 500,000 operations minimum (operating frequency 1800 per hour) [AC 15] 240V AC 2A inductive load: 100,000 operations minimum (operating frequency 1200 per hour, cos φ = 0.3) [DC 13] 24V DC 1A inductive load: 100,000 operations minimum (operating frequency 1200 per hour, L/R = 48 ms)			
Mechanical Life		10 million operations minimum (operating frequency 10,800 operations per hour)			
Operating Temperature (Note 4)		-40 to +85°C (no freezing)			
Storage Temperature		-40 to +85°C (no freezing)			
Operating Humidity		5 to 85% RH (no condensation)			
Storage Humidity		5 to 85% RH (no condensation)			
Operating Frequency (rated load)		1200 operations per hour			
Weight (approx.)		20g		23g	

Note 1: Measured using 6V DC, 1A voltage drop method.

Note 2: Failure rate level P, 1/10,000,000 (reference value) (JIS C5003)

Note 3: Response time is the time until NO contact opens, after the coil voltage is turned off.

Note 4: When using at 70 to 85°C, reduce the switching current by 0.1A/°C.

RF1V Force Guided Relays

Characteristics

Maximum Switching Capacity

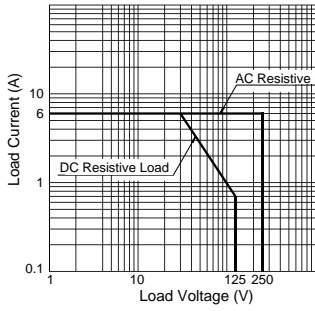

Electrical Life Curve

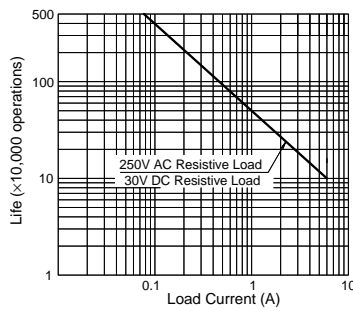

Notes on Contact Gaps except Welded Contacts

Example: RF1V-2A2B-D24

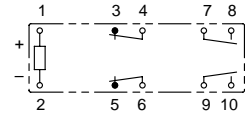

- If the NO contact (7-8 or 9-10) welds, the NC contact (3-4 or 5-6) remains open even when the relay coil is de-energized, maintaining a gap of 0.5 mm. The remaining unwelded NO contact (9-10 or 7-8) is either open or closed.
- If the NC contact (3-4 or 5-6) welds, the NO contact (7-8 or 9-10) remains open even when the relay coil is energized, maintaining a gap of 0.5 mm. The remaining unwelded NC contact (5-6 or 3-4) is either open or closed.

RF1V Dimensions

RF1V (4-pole)

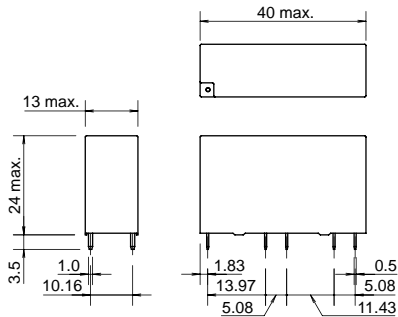

RF1V (6-pole)

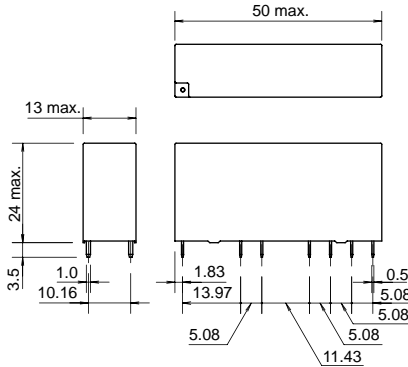

PC Board Terminal

Mounting Hole Layout (Bottom View)

RF1V (4-pole)

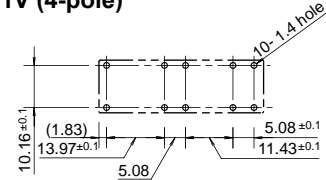

RF1V (6-pole)

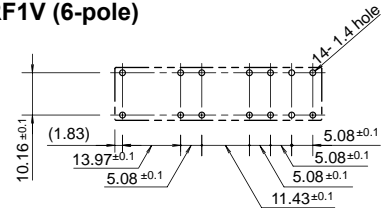

Internal Connection (Bottom View)

RF1V (4-pole)

Without LED Indicator

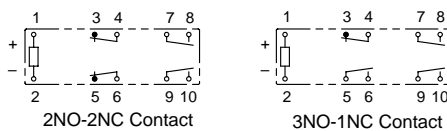

RF1V (6-pole)

Without LED Indicator

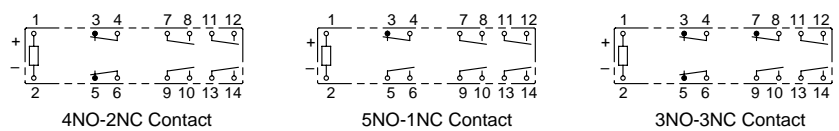

With LED Indicator

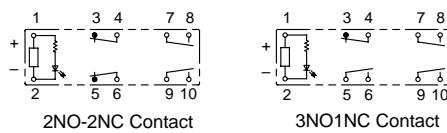

With LED Indicator

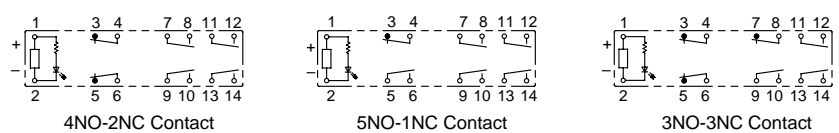

Instructions

1. Driving Circuit for Relays

1. To make sure of correct relay operation, apply rated voltage to the relay coil. Pickup and dropout voltages may differ according to operating temperature and conditions.

2. Input voltage for DC coil:

A complete DC voltage is best for the coil power to make sure of stable operation. When using a power supply containing a ripple voltage, suppress the ripple factor within 5%. When power is supplied through a rectifications circuit, relay operating characteristics, such as pickup voltage and dropout voltage, depend on the ripple factor. Connect a smoothing capacitor for better operating characteristics as shown below.

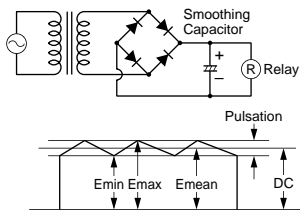

$$\text{Ripple Factor (\%)} = \frac{E_{\max} - E_{\min}}{E_{\text{mean}}} \times 100\%$$

E_{max} = Maximum of pulsating current
E_{min} = Minimum of pulsating current
E_{mean} = DC mean value

3. Operating the relay in sync with an AC load:

If the relay operates in sync with AC power voltage of the load, the relay life may be reduced. If this is the case, select a relay in consideration of the required reliability for the load. Or, make the relay turn on and off irrespective of the AC power phase or near the point where the AC phase crosses zero voltage.

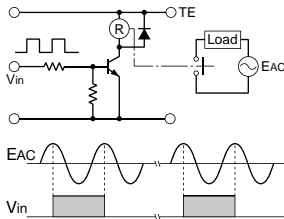

4. Leakage current while relay is off:

When driving an element at the same time as the relay operation, special consideration is needed for the circuit design. As shown in the incorrect circuit below, leakage current (I_o) flows through the relay coil while the relay is off. Leakage current causes coil release failure or adversely affects the vibration resistance and shock resistance. Design a circuit as shown in the correct example.

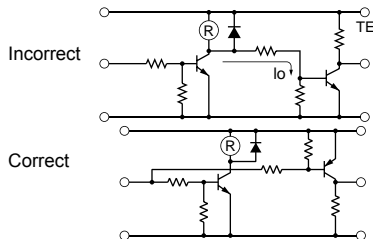

5. Surge suppression for transistor driving circuits:

When the relay coil is turned off, a high-voltage pulse is generated. Be sure to connect a diode to suppress the counter electromotive force. Then, the coil release time becomes slightly longer. To shorten the coil release time, connect a Zener diode between the collector and emitter of the controlling transistor. Select a Zener diode with a Zener voltage slightly higher than the power voltage.

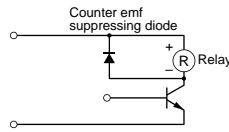

6. The coil terminal of the relay has polarity. Connect terminals according to the internal connection diagram. Incorrect wiring may cause malfunction.

2. Protection for Relay Contacts

1. The contact ratings show maximum values.

Make sure that these values are not exceeded. When an inrush current flows through the load, the contact may become welded. If this is the case, connect a contact protection circuit, such as a current limiting resistor.

2. Contact protection circuit:

When switching an inductive load, arcing causes carbides to form on the contacts, resulting in an increased contact resistance. In consideration of contact reliability, contact life, and noise suppression, use of a surge absorbing circuit is recommended. Note that the release time of the load becomes slightly longer. Check the operation using an actual load. Incorrect use of a contact protection circuit will adversely affect switching characteristics. Four typical examples of contact protection circuits are shown in the following table:

RC		This protection circuit can be used when the load impedance is smaller than the RC impedance in an AC load power circuit. R: Resistor of approximately the same resistance value as the load C: 0.1 to 1 μF
Diode		This protection circuit can be used for DC load power circuits. Use a diode with the following ratings: Reverse withstand voltage: Power voltage of the load circuit × 10 Forward current: More than the load current
Varistor		This protection circuit can be used for both AC and DC load power circuits. For a best result, when using on a power voltage of 24 to 48V AC/DC, connect a varistor across the load. When using on a power voltage of 100 to 240V AC/DC, connect a varistor across the contacts.

3. Do not use a contact protection circuit as shown below:

	This protection circuit is very effective in arc suppression when opening the contacts. But, the capacitor is charged while the contacts are opened. When the contacts are closed, the capacitor is discharged through the contacts, increasing the possibility of contact welding.
	This protection circuit is very effective in arc suppression when opening the contacts. But, when the contacts are closed, a current flows to charge the capacitor, causing contact welding.

Generally, switching a DC inductive load is more difficult than switching a DC resistive load. Using an appropriate arc suppressor will improve the switching characteristics of a DC inductive load.

3. Usage, transport, and storage conditions

1. Temperature, humidity, atmospheric pressure during usage, transport, and storage.

- ① Temperature: -45°C to +85°C (no freezing)
When the temperature is 70 to 80°C, reduce the 6A max. switching current by 0.1 A/°C
- ② Humidity: 5 to 85%RH (no condensation)
The humidity range varies with temperature. Use within the range indicated in the chart below.
- ③ Atmospheric pressure: 86 to 106 kPa

Operating temperature and humidity range

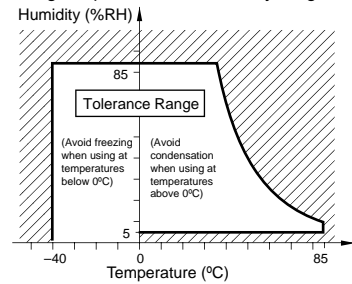

2. Condensation

Condensation occurs when there is a sudden change in temperature under high temperature and high humidity conditions. The relay insulation may deteriorate due to condensation.

3. Freezing

Condensation or other moisture may freeze on the relay when the temperatures is lower than 0°C. This causes problems such as sticking of movable parts or delay in operation.

4. Low temperature, low humidity environments

Plastic parts may become brittle when used in low temperature and low humidity environments.

4. Panel Mounting

When mounting DIN rail mount sockets on a panel, take the following into consideration.

- Use M3.5 screws, spring washers, and hex nuts.
- For mounting hole layout, see the dimensions on page 56.
- Keep the tightening torque within 0.49 to 0.68 N·m. Excessive tightening may cause damage to the socket.

5. Others

1. General notice:

- ① To maintain the initial characteristics, do not drop or shock the relay.
- ② The relay cover cannot be removed from the base during normal operation. To maintain the initial characteristics, do not remove the relay cover.
- ③ Use the relay in environments free from condensation, dust, sulfur dioxide (SO₂), and hydrogen sulfide (H₂S).
- ④ The RF1V relay cannot be washed as it is not a sealed type. Also make sure that flux does not leak to the PC board and enter the relay.

2. Connecting outputs to electronic circuits:

When the output is connected to a load which responds very quickly, such as an electronic circuit, contact bouncing causes incorrect operation of the load. Take the following measures into consideration.

- ① Connect an integration circuit.
- ② Suppress the pulse voltage due to bouncing within the noise margin of the load.
3. Do not use relays in the vicinity of strong magnetic field, as this may affect relay operation.
4. UL and CSA ratings may differ from product rated values determined by IEC.

6. Notes on PC Board Mounting

- When mounting 2 or more relays on a PC board, keep a minimum spacing of 10 mm in each direction. If used without spacing of 10 mm, rated current and operating temperature differs. Consult IEC.
- Manual soldering: Solder the terminals at 400°C within 3 sec.
- Auto-soldering: Preliminary heating at 120°C within 120 sec. Solder at 260°C±5°C within 6 sec.
- Because the terminal part is filled with epoxy resin, do not excessively solder or bend the terminal. Otherwise, air tightness will degrade.
- Avoid the soldering iron from touching the relay cover or the epoxy filled terminal part. Use a non-corrosive resin flux.

RF1V Force Guided Relays

Control circuits conforming with safety categories 2, 3, and 4 can be constructed.

Safety category 4 control circuits

The circuit example below consisting of interlock switches, force guided relays, and safety contactors are only a part of a safety-related system in a machine. In actual machines, risk assessment must be performed taking various aspects into consideration such as hazard types, safeguarding measures, and change of hazard level in operating mode, in order to reduce the risk of the entire machine to a tolerable level. The safety category of a machine needs to be evaluated for the entire safety-related system.

Safety function at occurrence of single faults

1. If a short-circuit failure occurs at either of the S1 channels, when the safety guard is opened, K2 does not turn off but K1 turns off, so safety function (power interruption to the motor) is maintained. The system does not restart because the NC contact of K2 remains open and K3 is not energized even when S2 is turned on.
2. If a short-circuit failure occurs between S1 channels, the potential difference of K1 and K2 coils become 0V, turning K1 and K2 off. (Fault detection function between safety input circuits)
3. If NO contact of KM1 is welded, KM2 turns off when the safety guard is opened, so the safety function (power interruption to the motor) is maintained. The system does not restart because the NC contact of KM1 remains open and K3 is not energized even when S2 is turned on.
4. If the NO contact of K1 is welded, K2 turns off when the safety guard is opened, so the safety function (power interruption to the motor) is maintained. The system does not restart because the NC contact of K1 remains open and K3 is not energized even when S2 is turned on.
5. If NC contact of K3 is welded, K1 and K2 turn off when the safety guard is opened, so the safety function (power interruption to the motor) is maintained. Also, the system does not restart because NO contact of K3 does not shut, therefore K1 and K2 cannot be energized.

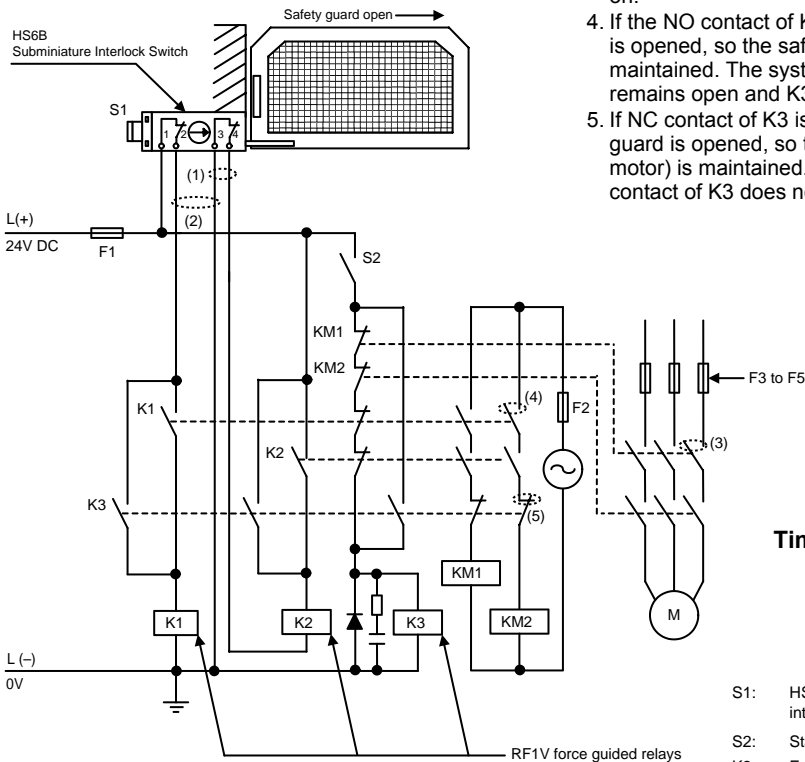

- S1: HS6B subminiature interlock switch
- S2: Start switch (HW series momentary)
- K1, K2, K3: RF1V force guided relays
- KM1, KM2: Safety contactor
- M: Motor
- F1: Protection fuse for safety circuit
- F2: Protection fuse for contact output of force guided relay contact
- F3 to F5: Protection fuse for contact output of safety contactors

Time Chart

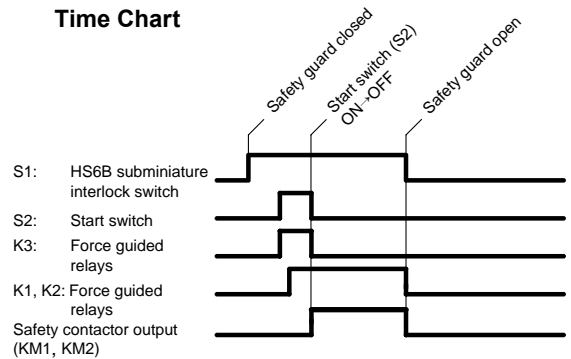

RR2KP Latch Relays

Self-maintained Latch Relays DPDT — 10A contact capacity

The RR2KP series latch relays have a self-holding function using permanent magnets in the magnetic circuit. Applying a voltage on the set (or reset) coil operates the armature and retains the contacts in that position until the opposite coil is energized, hence the latch relays are ideal for memory and flip-flop circuit applications.

- Enhanced self-holding functions, and vibration and shock resistance.
- The self-holding mechanism is not subject to wear unlike mechanical latch relays.
- Recognized by UL and certified by CSA.



Terminal Style	Style	Part No.	Coil Voltage Code *
Pin Terminal	Basic	RR2KP-U*	AC6, AC12, AC24, AC50, AC100, AC110, AC115, AC120, AC200, AC220, AC230, AC240
	With Check Button	RR2KP-UC*	DC6, DC12, DC24, DC48, DC110

Part No. Development

When ordering, specify the Part No. and coil voltage code.

(Example) **RR2KP-U** **AC110**

Part No. Coil Voltage Code

Coil Ratings

Rated Voltage (V)	Rated Current (mA) ±15% at 20°C		Coil Resistance (Ω) ±10% at 20°C	Operation Characteristics (against rated values at 20°C)	
	50Hz	60Hz		Maximum Continuous Applied Voltage	Set and Reset Voltage
AC (50/60Hz)	6	467	429	110%	80% maximum
	12	200	184		
	24	100	92		
	50	48	44		
	100	24	22		
	110	23	21		
	115	23	21		
	120	24	22		
	200	12	11		
	220	10.9	10		
	230	11.1	10.2		
240	11.5	10.6			
DC	6	240		110%	80% maximum
	12	120			
	24	60			
	48	30			
	110	13.8			

Contact Ratings

Switching Voltage	Continuous Current	Maximum Contact Capacity				
		Allowable Contact Power		Rated Load		
		Resistive Load	Inductive Load	Voltage	Res. Load	Ind. Load
250V AC 125V DC	10A	1650 VA AC 300W DC	1100 VA AC 225W DC	110V AC	10A	7.5A
				220V AC	7.5A	5A
				30V DC	10A	7.5A
				100V DC	0.5A	0.3A

Note: Inductive load for rated load — $\cos \phi = 0.3$, L/R = 7 ms

UL Ratings

Voltage	Resistive	General Use	Motor Load
240V AC	10A	7A	1/3 HP
120V AC	10A	7.5A	1/4 HP
30V DC	10A	7A	—

CSA Ratings

Voltage	Resistive	General Use	Motor Load
240V AC	10A	7A	1/3 HP
120V AC	10A	7.5A	1/4 HP
100V DC	—	0.5A	—
30V DC	10A	7.5A	—

RR2KP Latch Relays

Specifications

Contact Material	Silver
Contact Resistance	30 mΩ maximum (initial value)
Operate Time	25 ms maximum (at the rated voltage)
Power Consumption (approx.)	AC: 2.4 VA (50 Hz), 2.2 VA (60 Hz) DC: 1.5W
Insulation Resistance	100 MΩ minimum (500V DC megger)
Dielectric Strength	Between live and dead parts: 1,500V AC, 1 minute Between contact and coil: 1,500V AC, 1 minute Between contacts of different poles: 1,500V AC, 1 minute Between contacts of the same pole: 1,000V AC, 1 minute
Operating Frequency	Electrical: 1800 operations/h maximum Mechanical: 18,000 operations/h maximum
Temperature Rise	Coil: 85°C maximum, Contact: 65°C maximum
Vibration Resistance	0 to 60 m/s ² (maximum frequency: 55 Hz), Frequency: 5 to 55 Hz, Amplitude: 0.5 mm
Shock Resistance	100 m/s ² minimum
Mechanical Life	5,000,000 operations minimum
Electrical Life	500,000 operations minimum (110V AC, 10A)
Operating Temperature	-5 to +40°C (no freezing)
Operating Humidity	45 to 85% RH (no condensation)
Weight (approx.)	170g

Dimensions

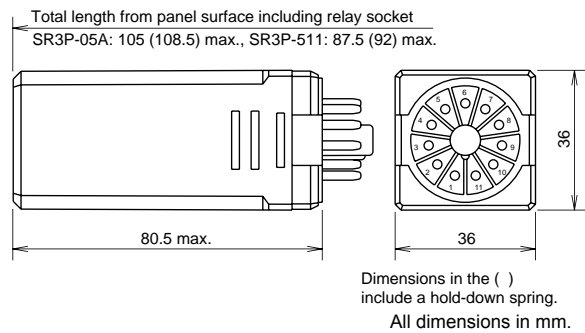

Applicable Socket and Hold-down Spring

Socket		Hold-down Spring
Mounting Style	Part No.	
DIN Rail Mount Socket	SR3P-05A	SR3P-06F3
	SR3P-05C	
	SR3P-06A	
Panel Mount Socket	w/Solder Terminals	SR3P-511F3
	w/Wire Wrap Terminals	

Characteristics (Reference Data)

Electrical Life Curve

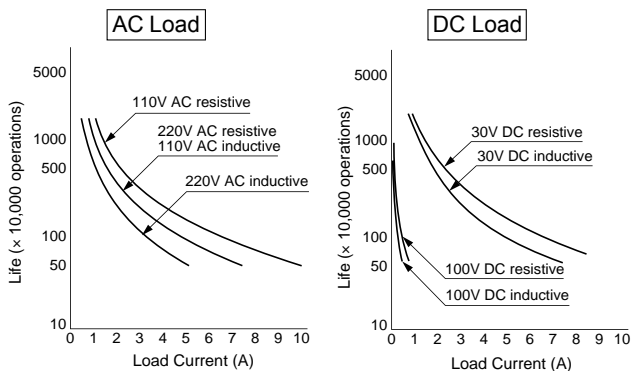

Internal Connection (Bottom View)

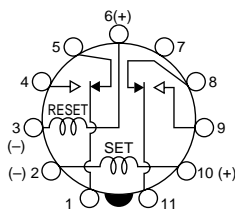

RY2KS Latch Relays

Self-maintained Latch Relays DPDT — 3A contact capacity

The RY2KS series latch relays have a self-holding function using permanent magnets in the magnetic circuit. Applying a voltage on the set (or reset) coil operates the armature and retains the contacts in that position until the opposite coil is energized, hence the latch relays are ideal for memory and flip-flop circuit applications.

- Mountable in the same space as other miniature relays using the same sockets.
- Recognized by UL and certified by CSA.

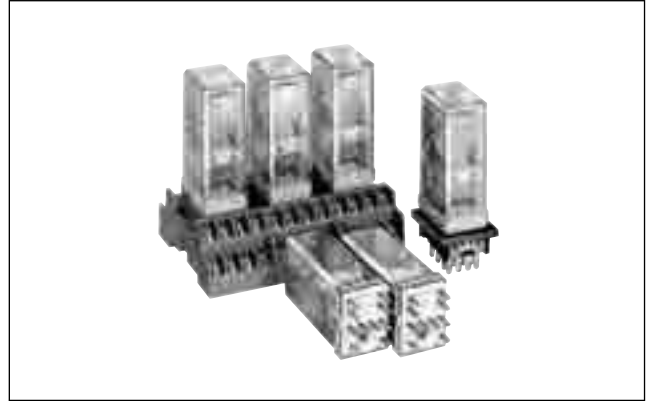

Terminal Style	Style	Part No.	Coil Voltage Code *
Plug-in Terminal	Basic	RY2KS-U*	AC6, AC12, AC24, AC50, AC100, AC120
	With Check Button	RY2KS-UC*	DC6, DC12, DC24, DC48, DC100, DC110

Part No. Development

When ordering, specify the Part No. and coil voltage code.

(Example) **RY2KS-U** **AC120**

Part No. Coil Voltage Code

Coil Ratings

Rated Voltage (V)	Rated Current (mA) ±15% at 20°C		Coil Resistance (Ω) ±10% at 20°C	Operation Characteristics (against rated values at 20°C)	
	50Hz	60Hz		Maximum Continuous Applied Voltage	Set and Reset Voltage
AC (50/60Hz)	6	260	250	110%	80% maximum
	12	120	115		
	24	58	56		
	50	27	26		
	100	13.5	13		
	120	11.2	10.8		
DC	6	200		110%	80% maximum
	12	100			
	24	50			
	48	25			
	100	12			
	110	11			

Contact Ratings

Maximum Contact Capacity						
Switching Voltage	Continuous Current	Allowable Contact Power		Rated Load		
		Resistive Load	Inductive Load	Voltage	Res. Load	Ind. Load
250V AC 125V DC	3A	660VA AC 90W DC	176VA AC 45W DC	110V AC	3A	1.5A
				220V AC	3A	0.8A
				30V DC	3A	1.5
				100V DC	0.2A	0.12A

Note: Inductive load for rated load — $\cos \theta = 0.3$, $L/R = 7$ ms

UL Ratings

Voltage	Resistive	General Use
240V AC	3A	0.8A
120V AC	3A	1.5A
30V DC	3A	—

CSA Ratings

Voltage	Resistive	General Use
240V AC	3A	0.8A
120V AC	3A	1.5A
100V DC	—	0.2A
30V DC	3A	1.5A

Specifications

Contact Material	Gold-plated silver
Contact Resistance	50 mΩ maximum (initial value)
Set Time	25 ms maximum (at the rated voltage)
Reset Time	25 ms maximum (at the rated voltage)
Power Consumption (approx.)	AC: 1.6 VA (50 Hz), 1.5 VA (60 Hz) DC: 1.2W
Insulation Resistance	100 MΩ minimum (500V DC megger)
Dielectric Strength	Between live and dead parts: 1,500V AC, 1 minute
	Between contact and coil: 1,000V AC, 1 minute
	Between contacts of different poles: 1,000V AC, 1 minute
	Between contacts of the same pole: 700V AC, 1 minute
Operating Frequency	Electrical: 1800 operations/h maximum Mechanical: 18,000 operations/h maximum
Temperature Rise	Coil: 85°C maximum, Contact: 65°C maximum
Vibration Resistance	0 to 60 m/s ² (maximum frequency: 55 Hz), Frequency: 5 to 55 Hz, Amplitude: 0.5 mm
Shock Resistance	200 m/s ² minimum
Mechanical Life	5,000,000 operations minimum
Electrical Life	200,000 operations minimum
Operating Temperature	-5 to +40°C (no freezing)
Weight (approx.)	67g

RY2KS Latch Relays

Characteristics (Reference Data)

Electrical Life Curve

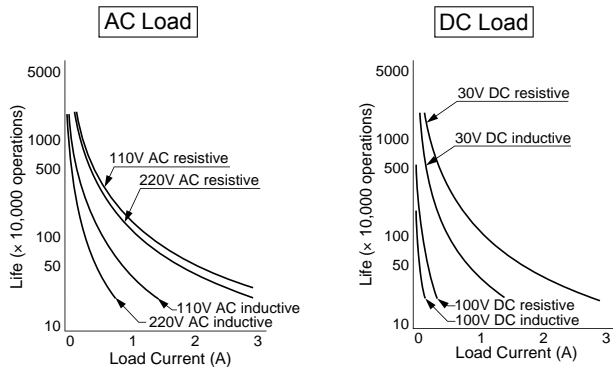

Internal Connection (Bottom View)

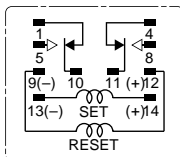

Dimensions

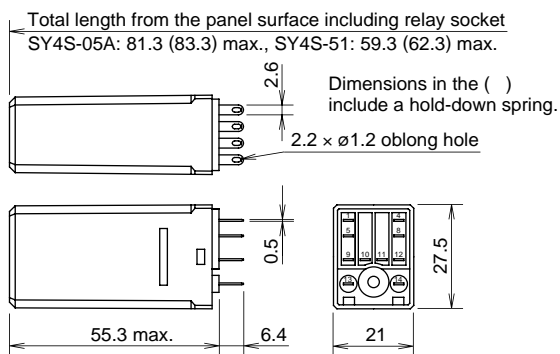

All dimensions in mm.

Applicable Socket and Hold-down Spring

Socket		Hold-down Spring
Mounting Style	Part No.	
DIN Rail Mount Socket	SY4S-05A SY4S-05C	SFA-202
Panel Mount Socket	SY4S-51	SY4S-51F3 (SY4S-02F3)
PC Board Mount Socket	SY4S-61	SFA-302
	SY4S-62	SY4S-51F3 (SY4S-02F3)

Notes:

- For the relays with check button, use the parenthesized hold-down springs shown in the above table. When the spring is used, sockets cannot be mounted closely side by side.
- Leaf springs come in pairs.
- Use the hold-down springs in environments where the relays are subject to vibrations or shocks.

For details about sockets and hold-down springs, see page 79.

Relay Sockets

SJ Series Relay Sockets	64
SJ Series PC Board Mount Sockets	68
DF Series Finger-safe Sockets	70
SU Series Spring Clamp Relay Sockets	73
SF1V Relay Sockets	77
Relay Sockets	79
Socket selection Guide	79
DIN Rail Mount Sockets	81
Panel Mount Sockets	87
PC Board Mount Sockets	89
Accessories	91

SJ series Relay Sockets

- 15.5-mm wide
- UL, CSA and CE are available.
- Release lever has an integrated extensible marking plate.
- Optional marking plate is also available. Can be attached to the release lever (at one position) and the socket (at 2 positions).
- The release lever makes installation and removal of relays inside small panels simple and quick.
- UL, CSA and CE are available.

Applicable Standard	Mark	File No.
UL508		UL recognized, File No. E62437
CSA C22.2 No. 14		CSA File No. LR84913
EN60999-1		EU Low Voltage Directive (Finger-safe screw terminal only)

Terminal Style	Part No.			
	1-pole		2-pole	
Terminal No. Marking Color	Black	White	Black	White
Standard Screw Terminal	SJ1S-05B	SJ1S-05BW	SJ2S-05B	SJ2S-05BW
Finger-safe Screw Terminal	SJ1S-07L	SJ1S-07LW	SJ2S-07L	SJ2S-07LW

Note: Release lever is supplied with each socket.

Specifications

Model	SJ1S	SJ2S
Rated Current	12A	8A
Rated Insulation Voltage	250V AC/DC	
Applicable Wire	2 mm ² maximum (14 AWG)	
Applicable Crimping Terminal	2 mm ² x 2	
Recommended Tightening Torque	1.0 N·m	
Screw Terminal Style	M3 slotted Phillips screw	
Terminal Strength	Wire tensile strength: 50N minimum	
Insulation Resistance	100MΩ minimum (500V DC megger)	
Dielectric Strength	Between live and dead metal parts: 2000V AC, 1 minute Between contact and coil: 4000V AC, 1 minute Between contacts of the same pole: 1000V AC, 1 minute Between contacts of the different poles: 3000V AC, 1 minute	
Vibration Resistance	Damage limits: 90 m/s ² Resonance: 10 to 55 Hz, amplitude 0.75 mm	
Shock Resistance	Damage limits: 1000 m/s ²	
Operating Temperature	-40 to +70°C (no freezing)	
Storage Temperature	-55 to +85°C (no freezing)	
Operating Humidity	5 to 85% RH (no condensation)	
Storage Humidity	5 to 85% RH (no condensation)	
Weight (approx.)	30g	34g

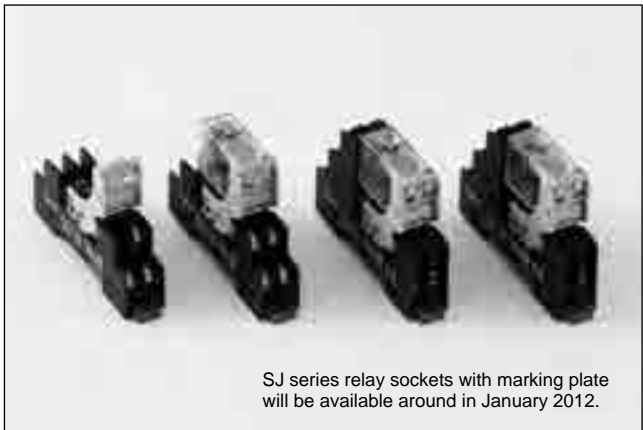

Applicable Crimping Terminals

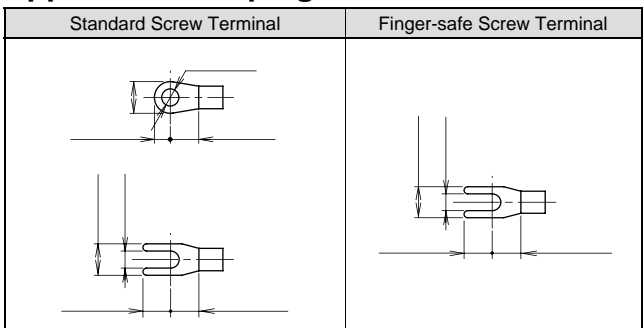

All dimensions in mm.

SJ series relay sockets with marking plate will be available around in January 2012.

Applicable Relay

Terminal Style	1-pole		2-pole	
	Socket	Relay	Socket	Relay
Standard Screw Terminal	SJ1S-05B SJ1S-05BW	RJ1S series	SJ2S-05B SJ2S-05BW	RJ2S series RJ22S series
Finger-safe Screw Terminal	SJ1S-07L SJ1S-07LW		SJ2S-07L SJ2S-07LW	

SJ series Relay Sockets

Dimensions

SJ1S-05B(W)

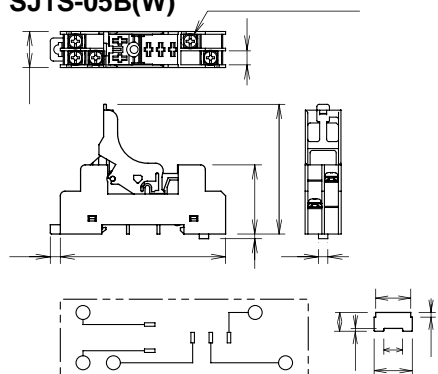

SJ2S-05B(W)

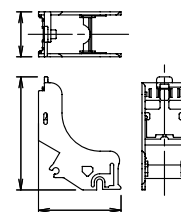
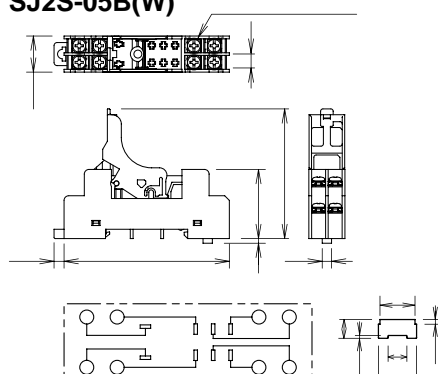

SJ1S-07L(W)

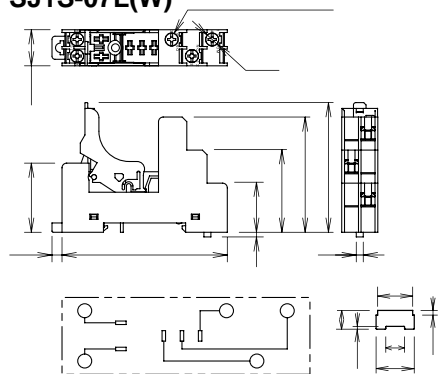

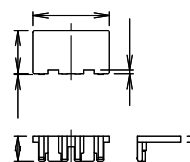
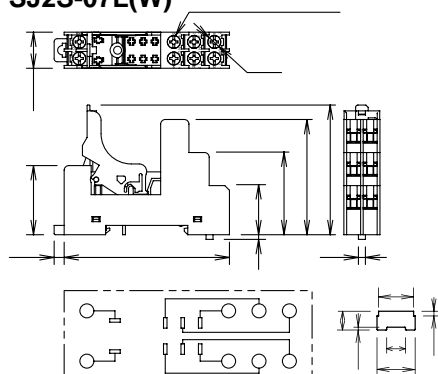

SJ2S-07L(W)





All dimensions in mm.

Replacement Parts

Description	Shape	Material	Part No.	Ordering No.	Package Quantity
Release Lever (with integrated marking plate)		Plastic (gray)	SJ9Z-CM	SJ9Z-CMPN05	5
Detachable Marking Plate (optional)		Plastic (white)	SJ9Z-PW	SJ9Z-PWPN05	5

Accessories

Description	Shape	Material	Part No.	Ordering No.	Package Quantity	Note
DIN Rail		Aluminum Weight: Approx. 200g	BAA1000	BAA1000PN10	10	Length: 1m Width: 35 mm
		Steel Weight: Approx. 200g	BAP1000	BAP1000PN10		
End Clip		Metal (zinc plated steel) Weight: Approx. 15g	BNL5	BNL5PN10	10	Used on a DIN rail to fasten relay sockets. To prevent the sockets from damage, position the clip before fastening.
			BNL6	BNL6PN10		
DIN Rail Spacer		Plastic (black)	SA-406B	SA-406B	1	Thickness: 5 mm Used for adjusting spacing between sockets mounted on a DIN rail
Jumper	For 2 sockets	Nickel-coated brass with polypropylene coating	SJ9Z-JF2	SJ9Z-JF2PN10	10	Terminal centers: 15.5mm Rated current: 12A Ensure that the total current to the jumper does not exceed the maximum current.
	For 5 sockets		SJ9Z-JF5	SJ9Z-JF5PN10		
	For 8 sockets		SJ9Z-JF8	SJ9Z-JF8PN10		
	For 10 sockets		SJ9Z-JF10	SJ9Z-JF10PN10		

SJ Series Relay Sockets

Safety Precautions

- Turn off power to the relay and the socket before starting installation, removal, wiring, maintenance, and inspection of the relays. Otherwise, there is a risk of electric shock or fire.
- Use wires of the proper size to meet the voltage and current requirements.

- Make sure that relay and output equipment are wired correctly. Otherwise, there is a risk of fire or electric shock.
- Prevent metal fragments and pieces of wire from dropping inside the socket. Otherwise, there is a risk of fire, damage, or malfunction.

Operating Instructions

Installing relays

The relay is installed on the socket using the release lever. Leaf spring is not necessary.

Rail Mounting and Removing

Do not mount or remove the socket in cold temperature (below -20°C), otherwise the socket may be damaged.

Applicable Screwdriver

Standard Screw Terminal

Phillips: $\phi 6.4$ mm maximum
Slotted: Shown at right

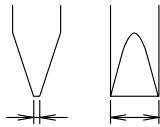

Finger-safe Screw Terminal

Phillips: $\phi 5.5$ mm maximum
Slotted: Shown at right

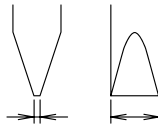

Installing relays

1. Unlock the release lever by pulling down as shown with arrow ①.
2. Press relay against the socket as shown with arrow ②.
3. When installed properly, the relay and the socket look as shown in ③.

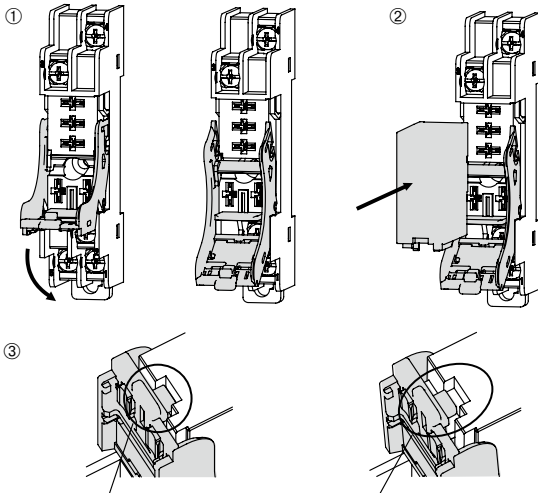

Caution

Ensure that the relay is installed in the socket completely. When installed loosely, the relay may fall out, resulting in possible damage to the relay.

Removing the release lever

- ① Lightly press the relay to prevent it from falling off.
- ② Pull down the release lever to the direction shown by the arrow until it touches the socket. Pull down further, and the lever will be detached from the socket.

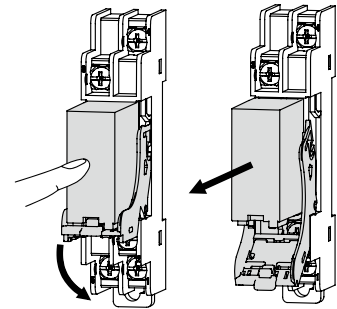

Caution

- Because release lever is detachable, make sure not to apply excessive force. Otherwise the relay may fall and result in damage.

Panel Mounting

Insert the anti-rotation projection into the anti-rotation hole. Mount the socket onto the panel using M3 screws (not provided). Use a screwdriver with diameter of $\phi 5.5$ mm maximum.

Mounting Hole Layout

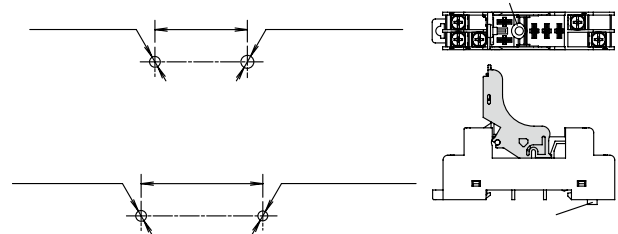

- Tighten the mounting screws to a torque of 1.0 N·m. Tightening with higher torque will damage the socket.
- The round rib projecting from the socket bottom prevents rotation when the socket is mounted on the panel directly.

Removing the Release Lever

Pull down the release lever to the direction shown by the arrow until it touches the socket. Pull down further, and the lever will be detached from the socket.

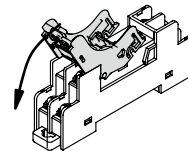

Caution

Make sure that the relay has been removed from the socket before removing the release lever. If the release lever is removed when the relay is installed on the socket, the relay may fall out.

Operating Instructions

Installing the Release Lever

- ① Attach part A to part B.
- ② Slide the release lever in the direction of the arrow until part A runs out of part B.
- ③ Rotate the release lever, with the center of rotation at part C until part A touches the rotation axis.
- ④ Push the rib of the release lever against the socket.
- ⑤ Complete the installation.

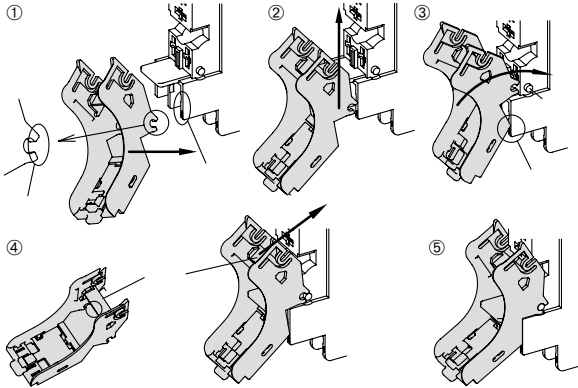

Using Marking Plate integrated with SJ9M-CM Release Lever

- ① Using a nipper, cut the marking plate at the separation part shown below, so that the marking plate can be lifted. (Note)
- ② Lift the marking plate as shown with the arrow, past the projections.
- ③ Marking plate is in place.

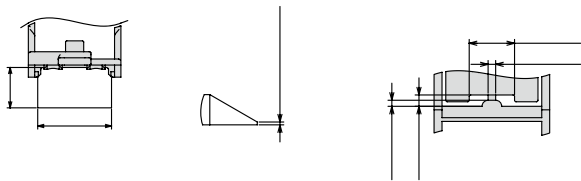
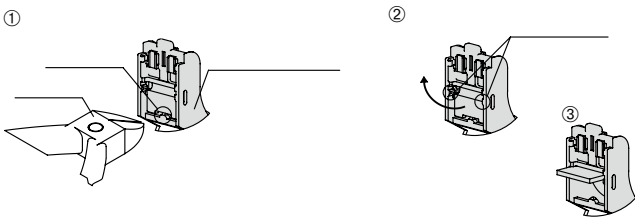

- The integrated marking plate must be retracted to the original position when wiring.
- The SJ9Z-CM integrated marking plate can be lifted and retracted for 50 times minimum.

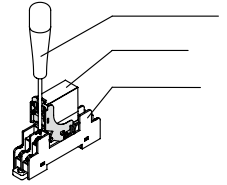

Using SJ9Z-PW Detachable Marking Plate (optional)

- ① Insert the marking plate into the slot on the release lever or socket.
- Note: SJ9Z-PW detachable marking plate cannot be installed on the SJ1S-05B(W)/SJ2B-05B(W) socket.
- ② The marking plate is installed.

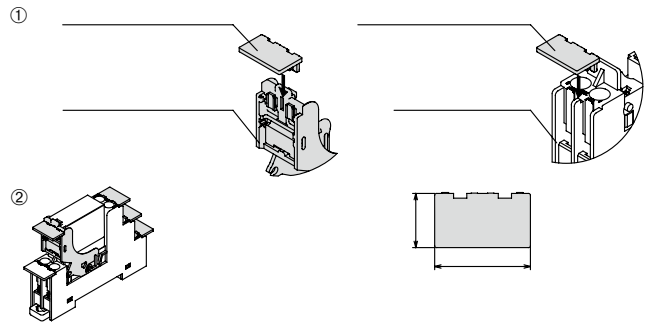

Current



Check the current of relay and ensure that the current is maintained below the values shown in the following table.

	SJ1S-05B(W)			SJ1S-07L(W)			SJ2S-05B(W)			SJ2S-07L(W)		
Ambient Temperature	70°C	55°C	40°C	70°C	55°C	40°C	70°C	55°C	40°C	70°C	55°C	40°C
Single mount	12A			12A			8A			8A		
Collective mount	11A*	12A		10A*	11A	11A	7A*	8A		6A*	7A	8A

* When installing AC relays, maintain at least 4mm between the sockets.

SJ series Relay Sockets (PC Board Terminal)

- Used for RJ series plug-in terminal relay.
- 1-pole: 12, 2-pole: 8A
- Latch makes it easy to install and removal the relay.

Applicable Standards	Mark	File No.
UL508		UL recognized, UL File No. E62437
CSA C22.2 No. 14		CSA File No. LR84913
EN60999-1		EU Low Voltage Directive (Finger-safe screw terminal only)



Sockets

No. of Poles	Part No.	Ordering No.	Package Quantity
1-pole	SJ1S-61	SJ1S-61PN10	10
	SJ1S-61	SJ1S-61PN50	50
2-pole	SJ2S-61	SJ2S-61PN10	10
	SJ2S-61	SJ2S-61PN50	50

Specifications

Model	SJ1S-61	SJ2S-61
Rated Current	12A	8A
Rated Insulation Voltage	250V AC/DC	
Insulation Resistance	100M Ω minimum (500V DC megger)	
Dielectric Strength	Between contact and coil:	5000V AC, 1 minute
	Between contacts of the same pole:	1000V AC, 1 minute
	Between contacts of the different pole:	3000V AC, 1 minute
Vibration Resistance	Damage limits: 90 m/s ² Resonance: 10 to 55 Hz, amplitude 0.75 mm	
Shock Resistance	Damage limits: 1000 m/s ²	
Operating Temperature	-40 to +70°C (no freezing)	
Storage Temperature	-55 to +85°C (no freezing)	
Operating Humidity	5 to 85% RH (no condensation)	
Storage Humidity	5 to 85% RH (no condensation)	
Weight (approx.)	4.2g	4.5g

Dimensions

SJ1S-61

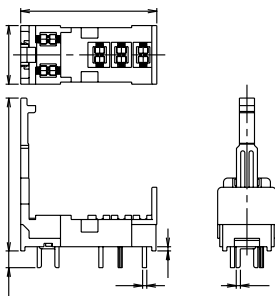

SJ2S-61

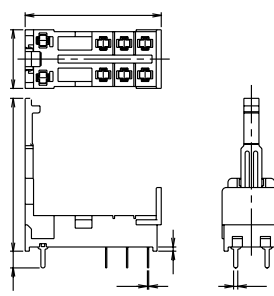

Mounting Hole Layout/Terminal Arrangement (bottom view)

SJ1S-61

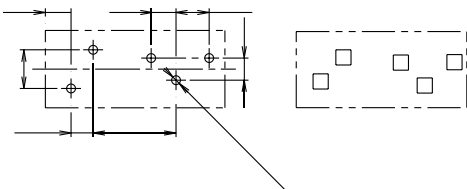

SJ2S-61

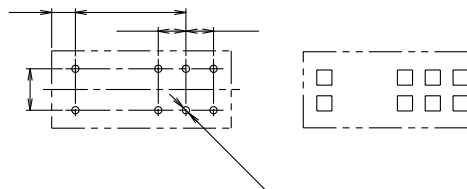

SJ Series Relay Sockets (PC Board Terminal)

Operating Instructions

Installing the relay

Press in the relay to the socket by guiding the latch to pass through the slit.

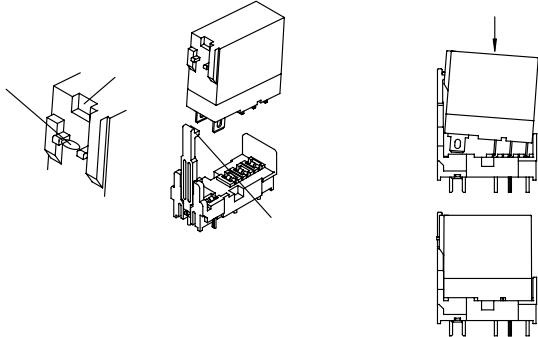

PC Board Pattern Design

Press in the relay to the socket by guiding the latch to pass through the slit.

On the bottom of SJ1S-61, metal parts other than the solder leads re exposed to the mounting side of PC board as]^| c \ -\ ^à &| ïï| c-\â êâ;[â â] b â[@âæ c-^ * . Take these metal parts into consideration when designing the PC board.

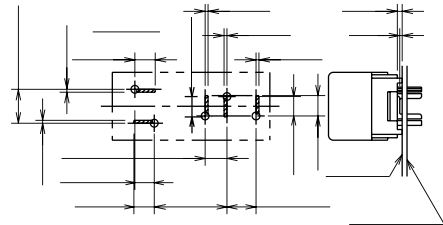

Ú^à [âiâç -] -\ {ââââ -& ^à ââ^â^ ê~} ^à â[| | •â â| b {ââââç. The latch swings open and can stop at the intermediate position.

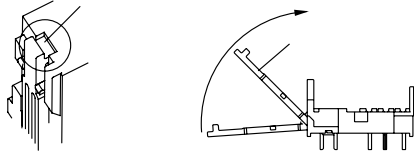

Removing the relay

Pull the latch, and pull out the relay from the socket.

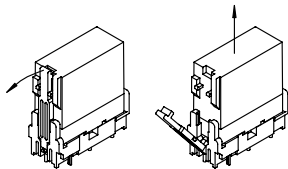

Ú^à [âiâç ââ\ 'à [âb | •âæ 'ç ê\ââ[] | ['ç |] -\â ^à removal tool (MT-101).

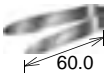
Description & Shape	Part No.
 60.0	MT-101

Soldering

Use a soldering iron of 60W (350°C), and quickly complete soldering with approximately 3 seconds. Æ| \ | ^ |]â ë| c |[æ- {] | ïïâ[-\â. Sn-Ag-Cu is recommended when using lead-free solder.

DF series Finger-safe Sockets

- Contains no lead, cadmium, mercury, hexavalent chromium, PBB, or PBDE.
- Accepts the same marking plates as the RU series
- Fork style jumpers available for easy wiring of adjoining sockets.
- The SM2S-05DF can also mount 4-pole relays when using only 2 poles.
- GT5Y miniature electric timer can be installed.
- UL, c-UL recognized, CE marked.

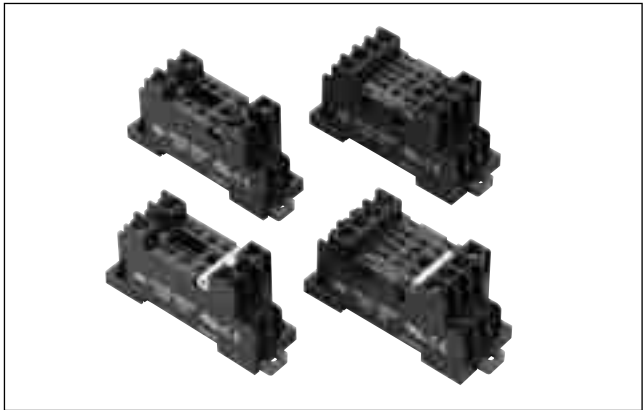

Applicable Standards	Mark	File No.
UL508 CSA C22.2 No. 14		UL/c-UL recognized File No. E188846
EN60999-1		EU Low Voltage Directive

Specifications

Model	SM2S-05DF	SY4S-05DF
No. of Poles	2 poles	4 poles
Rated Insulation Voltage	250V AC/DC	
Rated Current	10A	6A
Insulation Resistance	100 MΩ minimum (500V DC megger)	
Applicable Wire	1.25 mm ² (2 mm ² maximum)	
Screw Terminal	M3 slotted Phillips	
Terminal Screw Tightening Torque	0.6 to 1.0 N·m (maximum tightening torque: 1.2 N·m)	
Dielectric Strength	2000V AC, 1 minute (between live and dead metal parts, between live metal parts of different poles)	
Operating Temperature	-55 to +70°C (no freezing)	
Operating Humidity	45 to 85% RH (no condensation)	
Storage Temperature	-55 to +70°C (no freezing)	
Storage Humidity	45 to 85% RH (no condensation)	
Degree of Protection	IP20	
Weight	40g	56g
Applicable Relay/Timer	RU2S, RM2S, GT5Y-2	RU4S, RU42S, RY4S, RY42S, GT5Y-4
Applicable Hold-down Spring for Relay/Timer	SFA-503 (RU relay), SFA-502(RM relay), SFA-511 (timer)	SFA-502 (relay), SFA-511 (timer)
Standards	UL508, CSA C22.2 No. 14, EN60999-1	

Accessories

Name	Part No.	Ordering No.	Package Quantity	Description	
Relay Hold-down Spring	SFA-502	SFA-502PN20	20	Stainless steel	
	SFA-503 (Note 1)	SFA-503PN20		Stainless steel	
Timer Hold-down Spring	SFA-511	SFA-511PN20		Stainless steel	
Jumper (SM series)	2 sockets SM9Z-JF2	SM9Z-JF2PN10	10	For SM2S-05DF (Note 2)	
	5 sockets SM9Z-JF5	SM9Z-JF5PN10			
	8 sockets SM9Z-JF8	SM9Z-JF8PN10			
Jumper (SY series)	2 sockets SY9Z-JF2	SY9Z-JF2PN10		For SY4S-05DF (Note 2)	
	5 sockets SY9Z-JF5	SY9Z-JF5PN10			
	8 sockets SY9Z-JF8	SY9Z-JF8PN10			
Marking Plate	RU9Z-P*	RU9Z-P*PN10			Compatible with RU relays.
DIN Rail (1000 mm)	BAA1000	BAA1000PN10			Aluminum
	BAP1000	BAP1000PN10		Steel	
End Clip	BNL5	BNL5PN10		Steel	
	BNL6	BNL6PN10		Steel	
DIN Rail Spacer	SA-406B	SA-406B	1	Thickness: 5 mm Used for adjusting spacing between sockets mounted on a DIN rail	

Note 1: Used when using SM2S-05DF with RU relay (cannot be used with SY4S-05DF)

Note 2: Make sure that the total current to the jumper does not exceed the rated current.

- Insert a color code in place of *. A (amber), G (green), S (blue), W (white), Y (yellow)

DF Series Finger-safe Sockets

Dimensions

Sockets

SM2S-05DF

SY4S-05DF

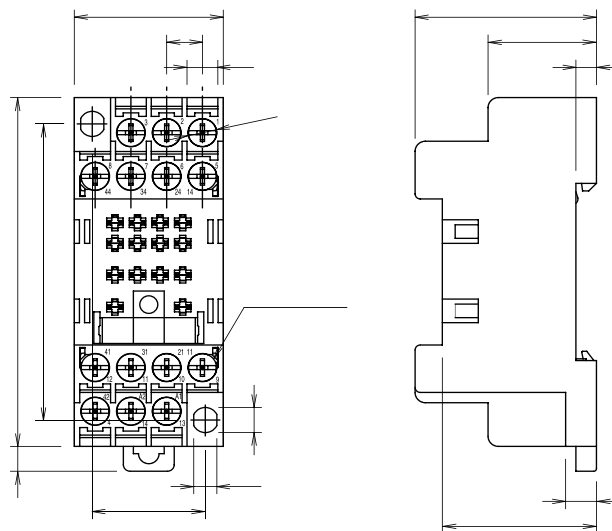
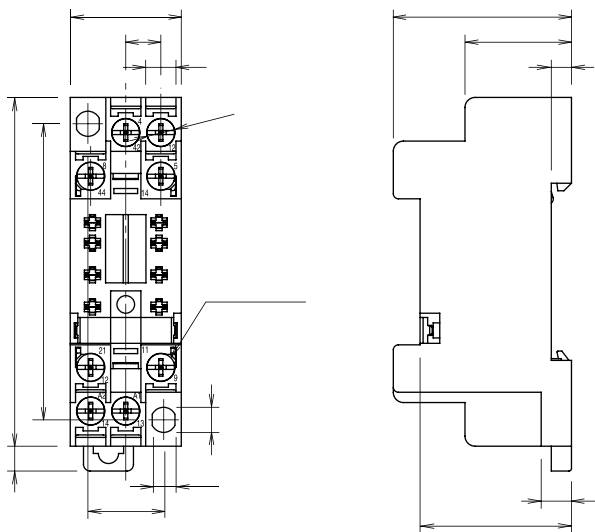

Terminal Arrangement

Mounting Hole Layout

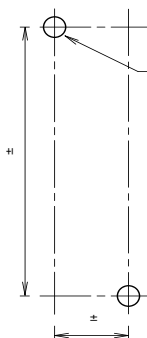
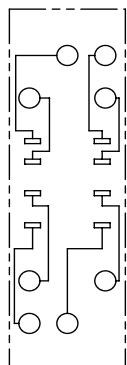

Applicable Crimping Terminal

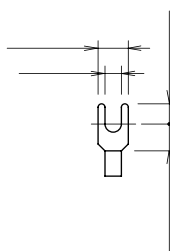

Terminal Arrangement

Mounting Hole Layout

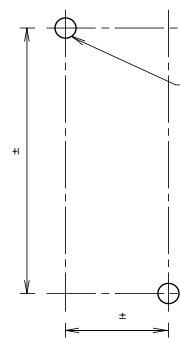
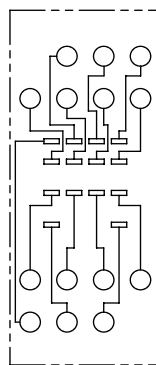

Applicable Crimping Terminal

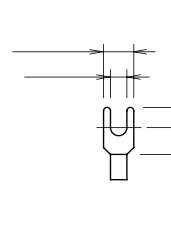

All dimensions are in mm.

Insulated Fork Jumpers

For SM2S-05DF

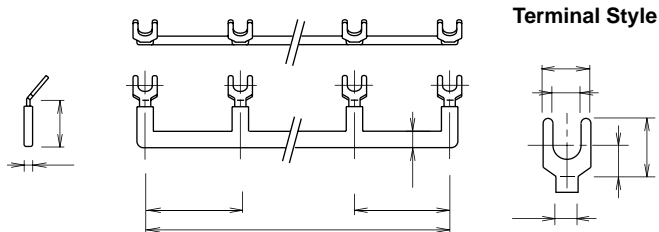

Terminal Style

Part No.	L (mm)	No. of Sockets
SM9Z-JF2	22	2
SM9Z-JF5	88	5
SM9Z-JF8	154	8

For SY4S-05DF

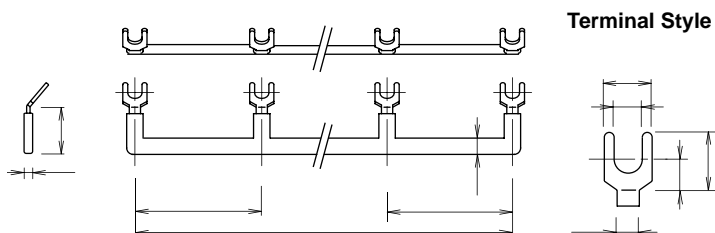

Terminal Style

Part No.	L (mm)	No. of Sockets
SY9Z-JF2	29	2
SY9Z-JF5	116	5
SY9Z-JF8	203	8

DF Series Finger-safe Sockets

Operating Instructions

Hold-down Springs

Installation

Insert hold-down springs into the grooves as shown below. Make sure that the small projections on the springs are facing outward.

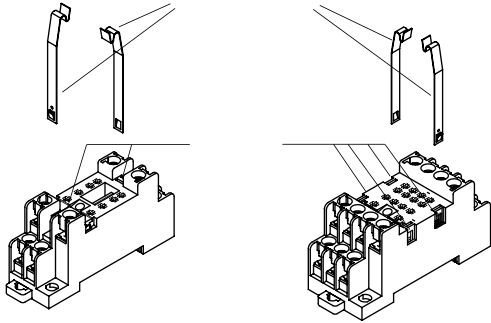

Removal

Remove hold-down springs by lifting them up while depressing the small projections on the hold-down springs.

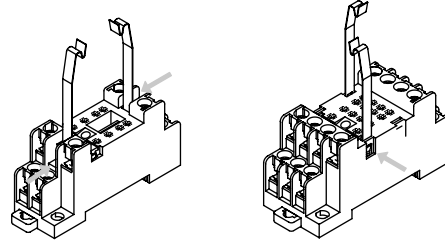

Using GT5Y-2 Timers and SM2S-05DF Sockets

When installing two or more GT5Y-2 timers on SM2S-05DF sockets in close mounting proximity as shown below, take the derating curve into consideration.

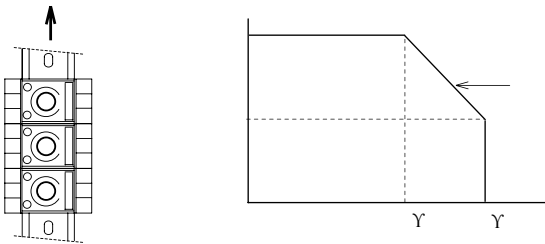

Safety Precautions



- Turn off power to the socket before starting installation, removal, wiring, maintenance, and inspection of the relays.
- Do not touch the terminals while power is applied, other-
- Use wires of the proper size to meet voltage and current requirements. Tighten terminal screws on the socket to

the proper tightening torque. Do not tighten more than the maximum torque. Also, do not leave the terminal screws

-



SU series Spring Clamp Relay Sockets

- Can be installed easily on 35-mm-wide DIN rail in snap-on action.
- Relay contact terminals on upper side and coil terminal on the lower provide higher safety and allows easy wiring.
- Finger-safe IP20 degree of protection (IEC 60529)
- Spring clamp style connection achieves high contact reliability and vibration resistance regardless of wire size and shape.
- Stranded wire, single wire, stranded wire with ferrule can be connected easily using a screwdriver.
- Wiring is possible only by stripping the wire. Crimp terminal and soldering are not necessary, reducing wiring and labor.
- Spring clamp eliminates loosening, reducing maintenance and labor. Each terminal has two wire ports, enabling jumper wiring. Jumper is available as accessory.
- Flameproof material UL94 V-0
- ÚQ [ää | á \ - , àæ] ÓÚN ää [- èàæ] ÓS ä | b { î-â \ }.

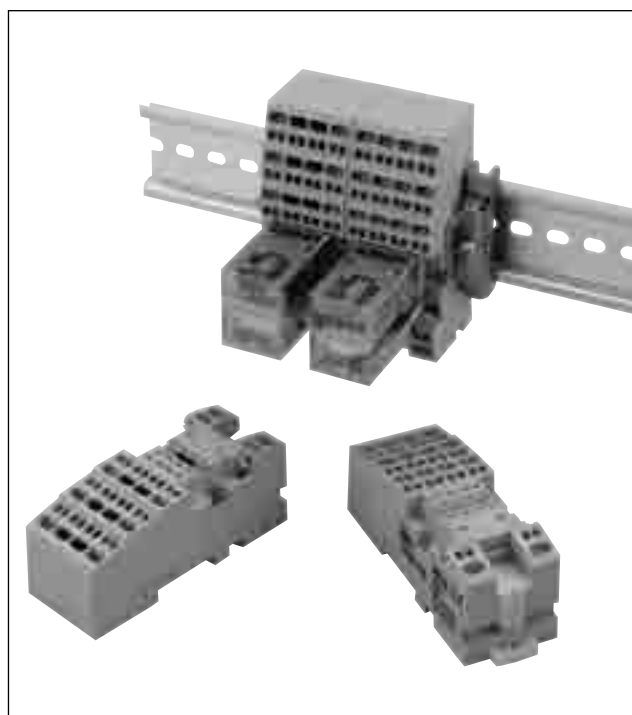
Applicable Standards	Mark	File No.
UL508		UL recognized UL File No. E62437
CSA C22.2 No. 14		CSA File No. LR84913
EN60999-1		EU Low Voltage Directive



Relay Sockets

Shape	No. of Poles	Part No.	Applicable Relay
	2	SU2S-11L	RU2S RM2S GT5Y-2
	4	SU4S-11L	RU4S, RY4S, RY42S, GT5Y-4

Specifications

Part No.		SU2S-11L	SU4S-11L
Operating Temperature		-55 to +70°C (no freezing)	
Operating Humidity		45 to 85% RH (no condensation)	
Storage Temperature		-55 to +70°C (no freezing)	
Storage Humidity		45 to 85% RH (no condensation)	
Applicable Wire	EN/IEC	Solid Wire	0.2 to 1.5mm ²
		Stranded Wire	0.2 to 1.25mm ²
	UL	AWG24-16	
Rated Insulation Voltage		250V	
Rated Current (Note)		10A 8A (collective mounting)	6A (4-pole) 10A (2-pole) 8A (2-pole, collective mounting)
Dielectric Strength		Between contacts of the different poles: 2500V AC, 1 min. (between live and dead metal parts, between live metal parts of the different poles)	
Insulation Resistance		100MΩ minimum	
Degree of Protection		IP20 (IEC 60529)	
Weight (approx.)		53g	63g

Note: When operating over the rated current in collective mounting, keep 10mm between the SU sockets.

Dimensions

SU2S-L/SU4S-11L

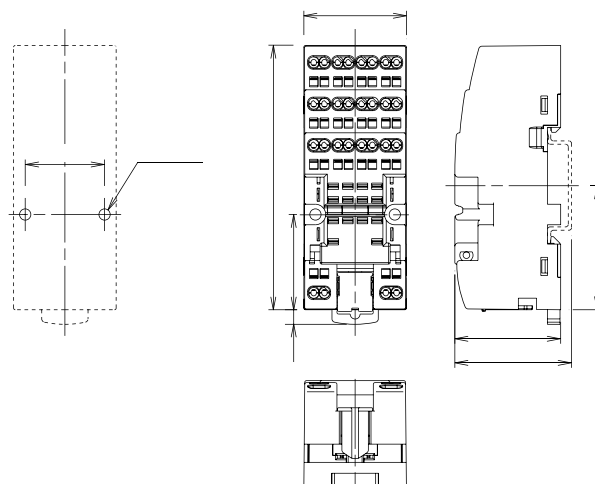



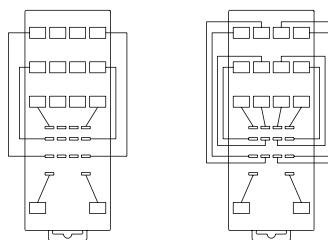

Terminal Arrangement (top view)



SU Series Spring Clamp Relay Sockets

Accessories

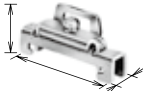
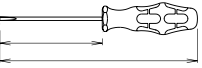
Name	Shape	Material	Weight	Part No.	Ordering No.	Package Quantity	Remarks
Jumper		Brass (ABS cover)	Weight: 3g (approx.)	SU9Z-J5	SU9Z-J5PN10	10	Used for interconnecting relay coil terminals. Can be cut to required length.
Hold-down Spring (leaf spring)		Stainless steel	Weight (a pair): 1g (approx.)	SFA-101	SFA-101PN20	10 pairs	A pair of springs are used for a relay.
		Stainless steel	Weight (a pair): 2g (approx.)	SFA-202	SFA-202PN20	10 pairs	
DIN Rail		Aluminum	Weight: 200g (approx.)	BAA1000	BAA1000PN10	10	Length: 1m Width: 35mm
		Steel	Weight: 320g	BAP1000	BAP1000PN10	10	
End Clip		Metal (zinc plated steel)	Weight: 15g (approx.)	BNL6	BNL6PN10	10	
Applicable Screwdriver			Weight: 20g (approx.)	BC1S-SD0	BC1S-SD0	1	Used to for wiring spring clamp relay sockets.

Note 2: Make sure that the total current to the jumper does not exceed the rated current.

Operating Instructions

Identifying Socket

SU2S-11L and SU4S-11L can be identified by the color of the cover as shown below.

Color	No. of Poles	Part No.
Black	2	SU2S-11L
Gray	4	SU4S-11L

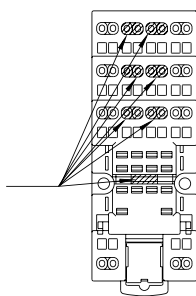

Applicable Wires

- Strip the wire insulation 9 to 10 mm from the end.
- When using stranded wires without ferrules, make sure that the core wires have not been loosened.



- In applications using ferrules for stranded wires, choose the ferrule listed in the table below. Make sure that an insulation sheath is applied when using the ferrules. When using

thin wires with insulation diameter of $\phi 1.6$ mm or less, do not insert the wire too deeply where the insulation inserts into the spring clamp opening. Make sure that the wire insulation is stripped 9 to 10 mm and the wire is inserted to the bottom.

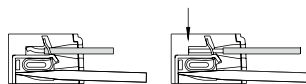

Applicable Ferrules

Applicable Wire (stranded)		Part No.	Manufacturer
mm ²	AWG		
0.25	24	AI 0.25-12BU	Phoenix Contact
—	22	AI 0.34-8TQ	
0.5	20	AI 0.5-8WH	
		AI 0.5-10WH	

Applicable Screwdriver

For wiring, use the optional screwdriver (BC1S-SD0) or the following applicable screwdriver.

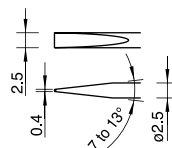

Parts Description

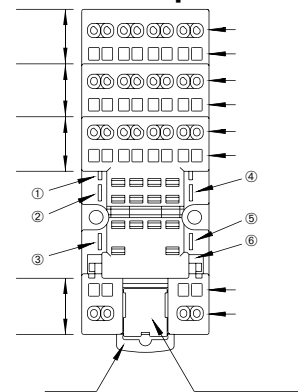

①②⑤⑥
③④⑦

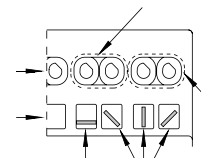

SU Series Spring Clamp Relay Sockets

Operating Instructions

Wiring Instructions

1. Insert the optional screwdriver (BC1S-SD0) or an applicable screwdriver into the square-shaped port as shown, until the screw-driver tip touches the bottom of the spring.

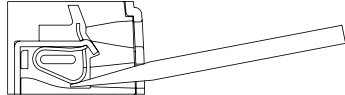

2. Push in the screwdriver until it touches the bottom of the port. The wire port is now open, and the screwdriver is held in place. The screwdriver will not come off even if you release your hand.



3. While the screwdriver is retained in the port, insert the wire or ferrule into the round-shaped wire port. Each wire port can accommodate one wire or ferrule. When connecting two wires to one terminal, use the adjoining port of the same terminal.

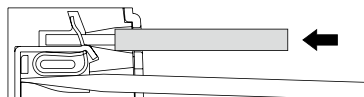

4. Pull out the screwdriver. The connection is now complete.

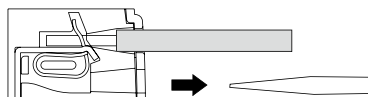

Do not tilt or turn the screwdriver while it is inserted into the screwdriver port in the socket, otherwise the socket may break.

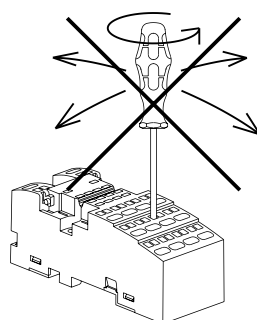

Installing the Hold-down Spring

Use SFA-101 or SFA-202 hold-down spring ordered separately (see page 74). To install, insert the springs into the spring slots with the projection on the springs facing each other. Once installed, the springs cannot be removed.

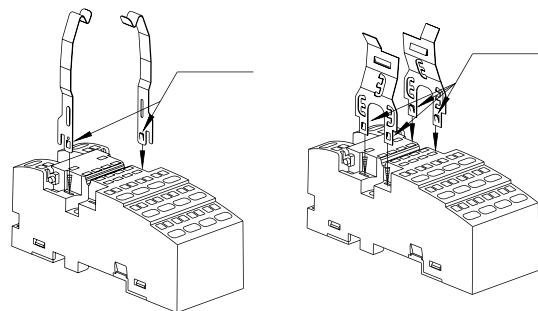

Installing the Marking Plate

Because of its removable structure, the marking plate may have fallen from the socket or become loose in delivery. Make sure that the marking plate is securely installed before starting operation. The marking plate protects the conductive portion of the socket, located under the marking plate, by preventing metal fragments or pieces of wire from dropping inside. Should any such fragments enter the

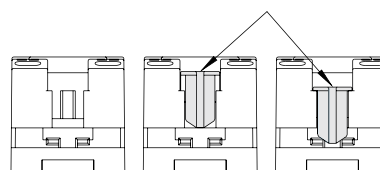

Marking Plate

Write markings on the SU sockets using an oil-based marker, or glue printed mylar on the marking surface. The size of the printed mylar can be 8 x 9 mm maximum.

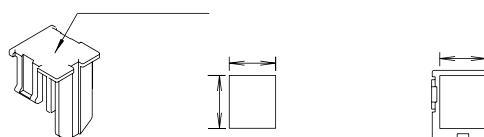

DIN Rail Mounting and Removing

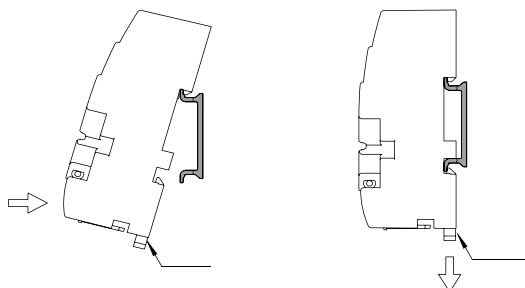

SU Series Spring Clamp Relay Sockets

Operating Instructions

SU9Z-J5 Jumper for SU2S-11L and SU4S-11L

When installing the SU9Z-J5 jumper, refer to the instructions described below.

The SU9Z-J5 is for coil terminals only.

DF*Kt; & ; f ^ aVc DaVTZ}TReZ`_d

Rated Current	3A	
Material	Conductor	Nickel-plated brass
	Sheath	ABS resin

Installing the SU9Z-J5 Jumper

Loosen the marking plate on the socket. Making sure that the SU9Z-J5 jumper is correctly aligned, insert the blades into the ports in the groove of the SU socket.

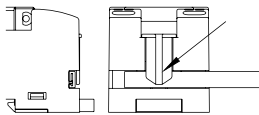
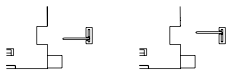
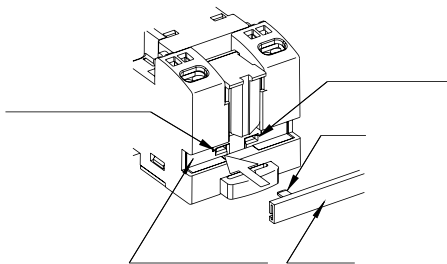

Jumper Wiring to Six or More SU Sockets

Use whole jumpers and the remaining sockets using a cut jumper. Then connect the two terminals on adjoining sockets using an applicable wire (see table below).

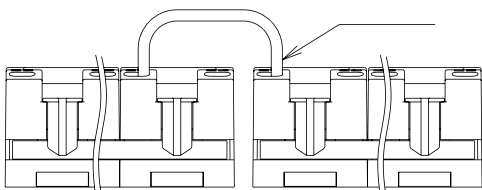

Wire	Size
Stranded Wire	0.2 to 1.25 mm ²
Solid Wire	0.2 to 1.5 mm ²
AWG	24 to 16

Note 1: Use a wire with cable insulation diameter of $\phi 3.15$ mm maximum.

Note 2: Strip the cable insulation 9 to 10 mm from the end.

Installing the SU9Z-J5 Jumper on Two, Three, or Four SU Sockets

As shown below, slide the jumper in the sheath so that the jumper aligns with the center of the sheath.

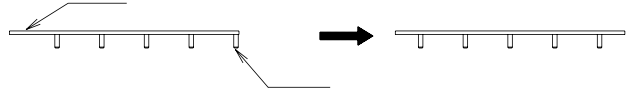

With the sheath properly installed on the jumper, cut the sheath and jumper at the points shown below, using cutting pliers. Referring to the drawing on the below right, make sure that the sheath and jumper are cut within the cutting area. Dispose of unused portions according to local waste disposal requirements.

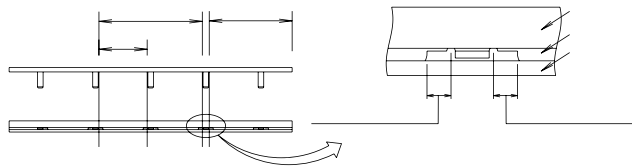

For Connecting	Jumper Quantity	Cutting Area	Discard
2 sockets	2	A, C	Y
2 sockets	1	A, B	X
3 sockets	1	A, B	X
4 sockets	1	D	Z

After cutting the jumper and sheath, slide the jumper as shown below, so that the ends of the jumper are not exposed.

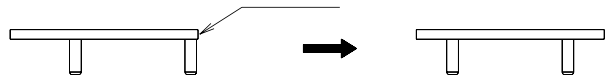





Safety Precautions

Turn off the power to the SU9Z-J5 jumper before starting installation, removal, wiring, maintenance, or inspection of the jumper, failure to turn power off may cause an electrical shock.

Check which terminals are connected to the jumper before starting wiring.

SF1V Relay Sockets

- Finger-safe DIN rail mount socket and PC board mount socket.
- CE, UL, and CSA compliant.
- UL, CSA, and EN compliant.

Applicable Standards	Mark	File No.
UL508		UL-c-UL recognized File No. E62437
CSA C22.2 No.14		CSA File No. 253350
EN147000 EN147100		TÜV SÜD
		EU Low Voltage Directive (DIN rail mount sockets only)





Socket Style	No. of Poles	Part No.
DIN Rail Mount Sockets	4	SF1V-4-07L
	6	SF1V-6-07L
PC Board Mount Sockets	4	SF1V-4-61
	6	SF1V-6-61

Specifications

Part No.	SF1V-4-07L	SF1V-6-07L	SF1V-4-61	SF1V-6-61
Rated Current	6A			
Rated Voltage	250V AC/DC			
Insulation Resistance	1000 MΩ minimum (500V DC megger, between terminals)			
Dielectric Strength	2500V AC, 1 minute (between terminals)			
Screw Terminal Style	M3 slotted Phillips screw		—	
Applicable Wire	0.7 to 1.65 mm ² (18 AWG to 14 AWG)		—	
Recommended Screw Tightening Torque	0.5 to 0.8 N·m		—	
Terminal Strength	Wire tensile strength: 50N min.		—	
Vibration Resistance	Damage limits: 10 to 55 Hz, amplitude 0.75 mm Resonance: 10 to 55 Hz, amplitude 0.75 mm			
Shock Resistance	1000 m/s ²			
Operating Temperature (Note)	-40 to + 85°C (no freezing)			
Storage Temperature	—			
Operating Humidity	5 to 85% RH (no condensation)			
Storage Humidity	—			
Degree of Protection	IP20 (between terminals)		—	
Weight (approx.)	40g	55g	9g	10g

Note: When using at 70 to 85°C, reduce the switching current by 0.1A/°C.

Accessories

Item	Shape	Weight	Ordering No.	Package Quantity	Remarks	
DIN Rail		Aluminum Weight: Approx. 200g	BAA1000	BAA1000PN10	10	Length: 1m Width: 35 mm
		Steel Weight: Approx. 320g	BAP1000	BAP1000PN10	10	
		Aluminum Weight: Approx. 250g	BNDN1000	BNDN1000	1	North American standard product Length: 1m Width: 35 mm
End Clip		Metal (zinc plated steel) Weight: Approx. 15g	BNL5	BNL5PN10	10	—
			BNL6	BNL6PN10	10	

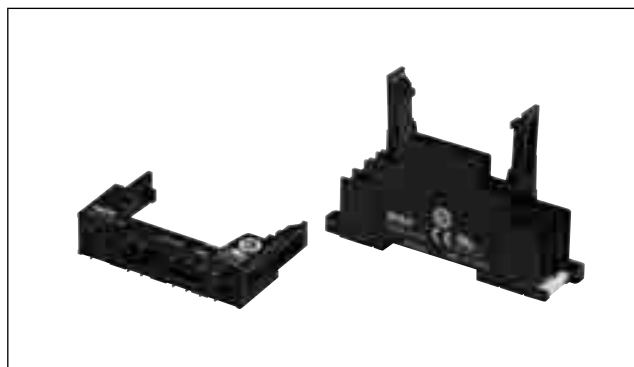

Operating Temperature

	Single Mounting (10mm spacing)	Collective Mounting	
Ambient Temperature	-40°C to +85°C	4-pole	-40°C to +70°C
		6-pole	-40°C to +65°C
Contact Current	6A	6A	
Remarks	When the ambient temperature is over 70°C, lower the contact current at 0.1A/°C. 5NO1NC: Up to 70°C: Keep the total current of NO side to 24A maximum. Over 70°C: Lower the contact current at 0.1A/°C.	4-pole	When the ambient temperature is over 70°C, lower the contact current at 0.1A/°C.
		6-pole	When the ambient temperature is over 50°C, lower the contact current at 0.1A/°C. NO1NC: Up to 50°C: Keep the total current of NO side to 24A maximum. Over 50°C: Lower the contact current at 0.1A/°C.

Applicable Crimping Terminals

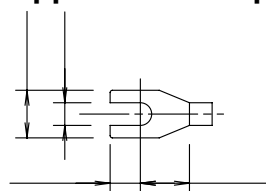

Note: Ring tongue terminals cannot be used.

SF1V Relay Sockets

SF1V DIN Rail Mount Socket Dimensions

SF1V-4-07L (4-pole)

(Internal Connection)

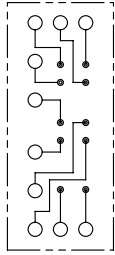

(Top View)

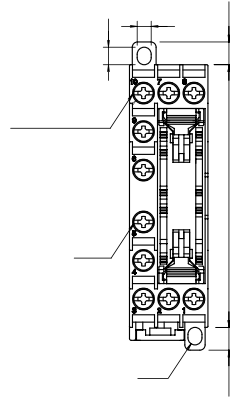

SF1V-6-07L (6-pole)

(Internal Connection)

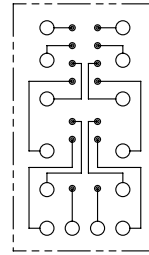

(Top View)

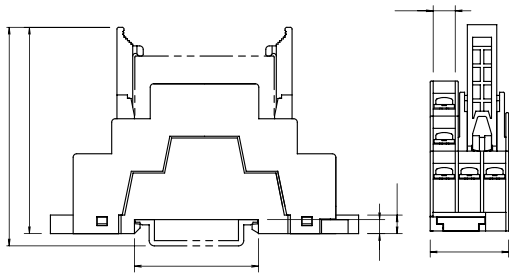
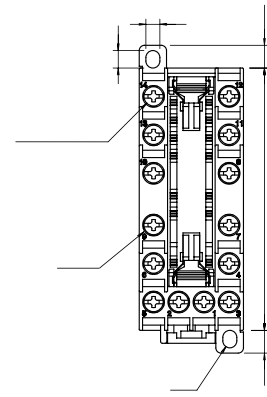

(Panel Mounting Hole Layout)

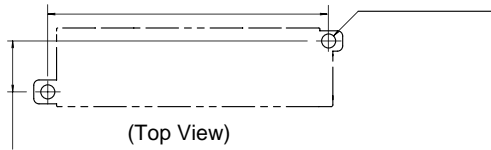

(Top View)

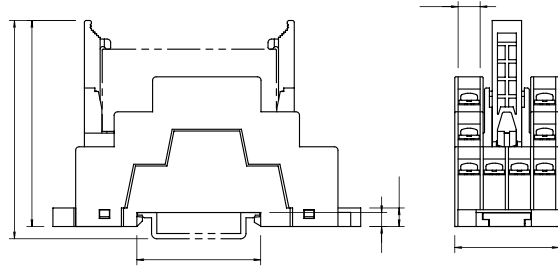

(Panel Mounting Hole Layout)

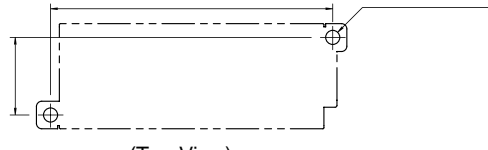

(Top View)

SF1V PC Board Mount Sockets

SF1V-4-61 (4-pole)

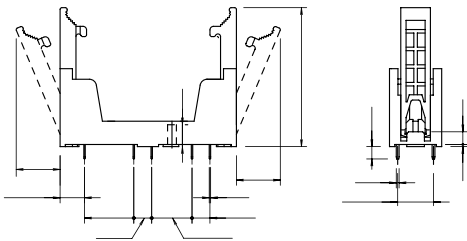
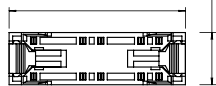

• PC Board Mounting Hole Layout / Terminal Arrangement (Bottom View)

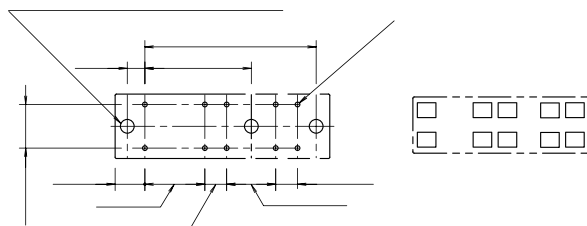

SF1V-6-61 (6-pole)

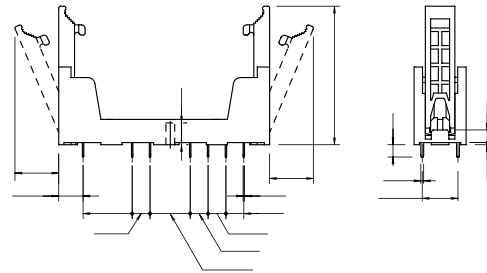
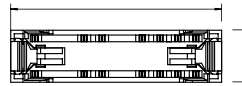

• PC Board Mounting Hole Layout / Terminal Arrangement (Bottom View)

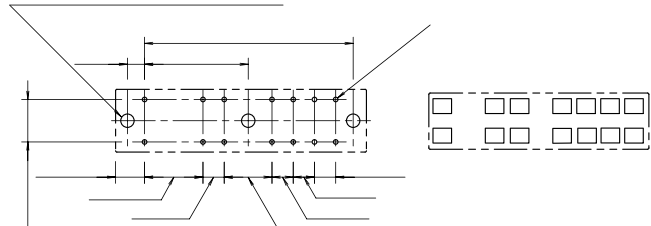

All dimensions in mm.

Relay Sockets

Socket Selection Guide

Mounting Style	Series	Part No.	Style	No. of Poles	Color	Terminal Screw Applicable Wire	Approvals	Rated Insulation Voltage/ Rated Current	Applicable Relay, etc.	Page						
DIN Rail Mount	SM	SM2S-05A	Standard	2	Black	M3 2 mm ² max.	—	250V, 7A 250V, 7A (UL, TÜV: 10A)	RM2S, RU2S, GT5Y-2	81						
		SM2S-05C	Finger-safe		Gray		UL, CSA, TÜV			81						
		SM2S-05D	Slim		Black		UL, c-UL			81						
		SM2S-05DF	Finger-safe							UL, c-UL, CE	82					
	SY	SY2S-05A	Standard	4	Black	M3 2 mm ² max.	—	250V, 7A	RY2S	82						
		SY2S-05C	Finger-safe		Gray		UL, CSA, TÜV			82						
		SY4S-05A	Standard		Black		—		RY4S, RY2KS, RU4S, RU42S, GT5Y-U	82						
		SY4S-05C	Finger-safe							Gray	UL, CSA, TÜV	82				
		SY4S-05D	Slim		Black		UL, c-UL		83							
		SY4S-05DF	Finger-safe						UL, c-UL, CE	83						
	SU	SU2S-11L	Spring-clamp	2	Gray	Solid wire: 0.2 to 1.5 mm ² Stranded wire: 0.2 to 1.25 mm ²	UL, CSA, CE	250V, 10A	RU2S, RM2S, GT5Y-2	83						
		SU4S-11L	Spring-clamp	4				250V, 6A	RU4S, RU42S, RY4S, GT5Y-4	83						
	SH	SH1B-05A	Standard	1	Black	M3.5 (coil terminal: M3) 2 mm ² max.	—	250V, 10A (coil terminal: 7A)	RH1B	83						
			Finger-safe		Gray		UL, CSA, TÜV			84						
		SH2B-05A	Standard	2	Black	M3.5 2 mm ² max.	—	250V, 10A	RH2B	84						
			Finger-safe		Gray		UL, CSA, TÜV			84						
		SH2B-05D	Slim	Black	UL, c-UL		84									
		SH3B-05A	Standard	3	Black		—		RH3B	84						
			Finger-safe		Gray		UL, CSA, TÜV			85						
		SH4B-05A	Standard	4	Black		—		RH4B	85						
			Finger-safe		Gray		UL, CSA, TÜV			85						
		SR	SR2P-05A	Standard	2		Black		M3.5 2 mm ² max.	—	250V, 10A	RR2P, GT3 (8-pin), GT5P	85			
			SR2P-05C	Finger-safe			Gray			UL, CSA, TÜV			85			
			SR2P-06A	Standard	Black		—			86						
			SR3P-05A	Standard	3		Black			M3.5 2 mm ² max.			—	250V, 10A	RR3P, RR3PA, RR2KP, GT3 (11-pin)	86
				Finger-safe			Gray						UL, CSA, TÜV			86
	SR3P-06A		Standard	Black	—		86									
	SR3B-05U	Standard	3	Gray	UL, CSA, TÜV		86									
Panel Mount	SM	SM2S-51	Solder	2	Black	—	UL, CSA	250V, 10A	RM2S, RU2S, GT5Y-2		87					
	SY	SY2S-51	Solder	2		—	UL, CSA	250V, 7A	RY2S, RY22S		87					
		SY4S-51		4		—	UL, CSA	250V, 7A (Note)	RY4S, RY2KS, RU4S, RU42S, GT5Y-U	87						
	SH	SH1B-51	Solder	1		—	UL, CSA	250V, 10A (coil terminal: 7A)	RH1B	87						
		SH2B-51		2		—	UL, CSA	250V, 10A	RH2B	87						
		SH3B-51		3		—	UL, CSA		RH3B	88						
		SH4B-51		4		—	UL, CSA		RH4B	88						
	SR	SR2P-511	Solder	2		—	UL, CSA		250V, 10A	RR2P, GT3 (8-pin), GT5P	88					
		SR2P-70	Wire-wrap			—	—	88								
		SR3P-511	Solder	3		—	UL, CSA	RR3P, RR3PA, RR2KP, RR1BA, RR2BA, RR3B			88					
		SR3P-70	Wire-wrap			—	—				89					
		SR3B-51	Solder			—	UL, CSA				89					
PC Board Mount	SM	SM2S-61	PC board	2	Black	—	UL, CSA	250V, 10A	RM2S, RU2S, GT5Y-2	89						
		SM2S-62				—	UL, CSA	RM2S, RU2S	89							
	SY	SY2S-61	PC board	2		—	UL, CSA	250V, 7A	RY2S, RY22S	89						
		SY4S-61		4		—	UL, CSA	250V, 7A (Note)	RY4S, RY2KS, RU4S, RU42S, GT5Y-U	89						
	SY4S-62					—	UL, CSA	250V, 7A		90						
	SH	SH1B-62		PC board		1	—	UL, CSA	250V, 10A (coil terminal: 7A)	RH1B	90					
		SH2B-62	2			—	UL, CSA	250V, 10A	RH2B	90						
		SH3B-62	3			—	UL, CSA		RH3B	90						
SH4B-62		4	—		UL, CSA	RH4B	90									

Note: When using only 2 poles of the 4-pole sockets SY4S-51 and SY4S-61, the UL rated current is 10A.

Terminal Screw Tightening Torque for DIN Rail Mount Sockets

Socket Series	Terminal Screw Tightening Torque	Socket Series	Terminal Screw Tightening Torque
SR	1.0 to 1.3 N·m	SM	0.6 to 1.0 N·m
SH	1.0 to 1.3 N·m	SY	0.6 to 1.0 N·m

Relay Sockets

Sockets and Applicable Hold-down Springs

DIN Rail Mount Sockets

Socket Part No.	Applicable Relays and Timers	Hold-down Spring	
		Wire Spring	Leaf Spring
SM2S-05A	RM2S, RU2S	—	SFA-101, SFA-202
	GT5Y-2	—	SFA-202
SM2S-05C	RM2S, RU2S	SY4S-02F1	SFA-101, SFA-202
	GT5Y-2	—	SFA-202
SM2S-05D	RM2S	—	SFA-502
	RU2S	—	SFA-503
SM2S-05DF	GT5Y-2	—	SFA-511
	—	—	—
SY2S-05A	—	—	SFA-101
SY2S-05C	RY2S, RY22S	SY2S-02F1	SFA-202
	—	—	—
SY4S-05A	RY4S, RU4S, RU42S	—	SFA-101, SFA-202
	RY2KS, GT5Y-4	—	SFA-202
SY4S-05C	RY4S, RU4S, RU42S	SY4S-02F1	SFA-101, SFA-202
	RY2KS, GT5Y-4	—	SFA-202
SY4S-05D	RY4S, RU4S, RU42S	—	SFA-502
	RY2KS, GT5Y-4	—	SFA-511
SY4S-05DF	RY4S, RU4S, RU42S	—	SFA-502
	GT5Y-4	—	SFA-511
SU2S-11L	RU2S, RM2S	—	SFA-101, SFA-202
	GT5Y-2	—	SFA-202
SU4S-11L	RU4S, RU42S, RY4S	—	SFA-101, SFA-202
	GT5Y-4	—	SFA-202
SH1B-05A	—	—	—
SH1B-05C	RH1B	—	SFA-101, SFA-202
	—	SY2S-02F1	—
SH2B-05A	RH2B	—	SFA-101, SFA-202
SH2B-05C	RH2B	SY2S-02F1	SFA-101, SFA-202
SH2B-05D	RH2B	—	SFA-502
SH3B-05A	—	—	SFA-101
SH3B-05C	RH3B	—	SFA-202
	—	SH3B-05F1	—
SH4B-05A	—	—	SFA-101
SH4B-05C	RH4B	—	SFA-202
	—	SH4B-02F1	—
SR2P-05A	RR2P	SR2B-02F1	—
SR2P-05C	GT5P	—	SFA-203
	—	—	—
SR2P-06A	RR2P	SR2B-02F1	SFA-202
	GT3 (8-pin), GT5P	—	SFA-202
SR3P-05A	RR3P, RR3PA	SR3B-02F1	—
	RR2KP	SR3P-06F3	—
SR3P-05C	GT3 (11-pin)	—	SFA-203
	—	—	—
SR3P-06A	RR3P, RR3PA	SR3B-02F1	SFA-202
	RR2KP	SR3P-06F3	—
SR3B-05U	GT3 (11-pin)	—	SFA-202
	RR1BA, RR2BA, RR3B	SR3B-02F1	SFA-202

Panel Mount Sockets and PC Board Mount Sockets

Socket Part No.	Applicable Relays and Timers	Hold-down Spring	
		Wire Spring	Leaf Spring
SM2S-51	RM2S, RU2S	SY4S-51F1 (SY4S-02F1)	SFA-301 SFA-302
	GT5Y-2	—	SFA-302
SM2S-62	RM2S, RU2S	SY4S-51F1 (SY4S-02F1)	SFA-504
SY2S-51	RY2S, RY22S	SY4S-51F1	SFA-301 SFA-302
	—	—	—
SY4S-51	RY4S, RU4S, RU42S	SY4S-51F1	SFA-301 SFA-302
	—	—	—
SY4S-61	RY2KS	SY4S-51F3 (SY4S-02F3)	SFA-302
	GT5Y-4	—	SFA-302
SY4S-62	RY4S, RU4S, RU42S	SY4S-51F1 (SY4S-02F1)	SFA-504
	RY2KS	SY4S-51F3 (SY4S-02F3)	—
SH1B-51	RH1B	SY4S-51F1	SFA-301 SFA-302
SH1B-62	—	—	—
SH2B-51	RH2B	SY4S-51F1 (SY4S-02F1)	SFA-301 SFA-302
SH2B-62	RH2B	SY4S-51F1 (SY4S-02F1)	SFA-504
SH3B-51	RH3B	SY4S-51F1 (SH3B-05F1)	SFA-301 SFA-302
SH3B-62	—	—	—
SH4B-51	RH4B	SY4S-51F1 x 2 (SH4B-02F1)	SFA-301 SFA-302
SH4B-62	—	—	—
SR2P-511	RR2P	SR3P-01F1	—
SR2P-70	GT3 (8-pin)	—	SFA-402
	GT5P	—	SFA-302
SR3P-511	RR3P, RR3PA	SR3P-01F1	—
	RR2KP	SR3P-511F3	—
SR3P-70	GT3 (11-pin)	—	SFA-402
	—	—	—
SR3B-51	RR1BA, RR2BA, RR3B	SR3B-02F1	—

Note 1: When mounting relays with check button on panel mount or PC board mount sockets, use hold-down springs shown in (). Hold-down springs for relays with check button are not available for SR2P-511, SR2P-70, SR3P-511, and SR3P-70.

Note 2: For close mounting of panel mount or PC board mount sockets, use wire springs or SFA-302 leaf springs.

Note 3: SM2S-62 and SY4S-62 sockets cannot be used on GT5Y-2 and GY5Y-4 timers.

Hold-down Springs

Style	Part No.	Ordering No.	Package Quantity
Wire Spring	SR2B-02F1	SR2B-02F1PN10	10
	SR3B-02F1	SR3B-02F1PN10	
	SR3P-01F1	SR3P-01F1PN10	
	SR3P-06F3	SR3P-06F3PN10	
	SR3P-511F3	SR3P-511F3PN10	
	SH3B-05F1	SH3B-05F1PN10	
	SH4B-02F1	SH4B-02F1PN10	
	SY2S-02F1	SY2S-02F1PN10	
	SY4S-02F1	SY4S-02F1PN10	
	SY4S-02F3	SY4S-02F3PN10	
	SY4S-51F1	SY4S-51F1PN10	
SY4S-51F3	SY4S-51F3PN10		
Leaf Spring	SFA-101	SFA-101PN20	20 (10 pairs)
	SFA-202	SFA-202PN20	
	SFA-203	SFA-203PN20	
	SFA-301	SFA-301PN20	
	SFA-302	SFA-302PN20	10
	SFA-402	SFA-402PN10	20
	SFA-502	SFA-502PN20	(10 pairs)
	SFA-504	SFA-504PN10	10
SFA-511	SFA-511PN20	20 (10 pairs)	

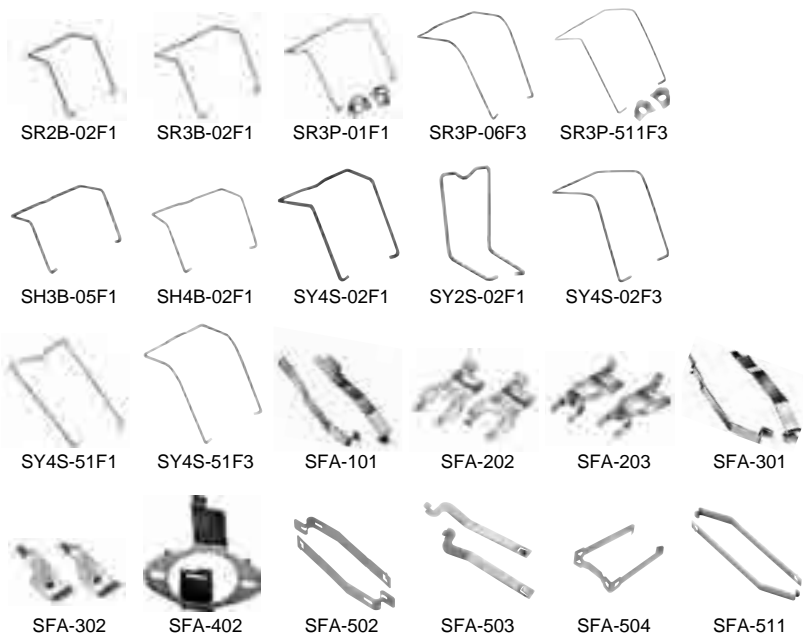

Accessories for Sockets

Name	Shape	Material	Weight	Part No.	Ordering No.	Package Quantity	Remarks
DIN Rail		Aluminum	Weight: Approx. 200g	BAA1000	BAA1000PN10	10	Length: 1m Width: 35 mm
		Steel	Weight: Approx. 320g	BAP1000	BAP1000PN10	10	
End Clip		Zinc-plated steel	Weight: Approx. 15g	BNL5	BNL5PN10	10	Used on a DIN rail to fasten relay sockets
				BNL6	BNL6PN10	10	
DIN Rail Spacer		Plastic (black)		SA-406B	SA-406B	1	Thickness: 5 mm Used for adjusting spacing between sockets mounted on a DIN rail
End Spacer		Plastic (black)		SA-203B	SA-203B	1	Used for mounting DIN rail mount sockets directly on a panel surface
Intermediate Spacer			SA-204B	SA-204B	1		

DIN Rail Mount Sockets

SM Series

SM2S-05A

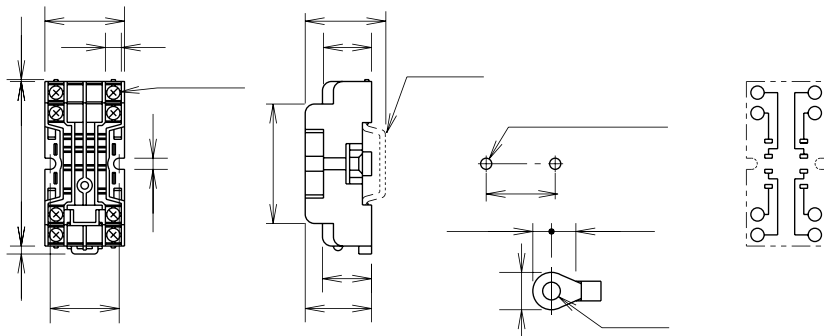

SM2S-05C

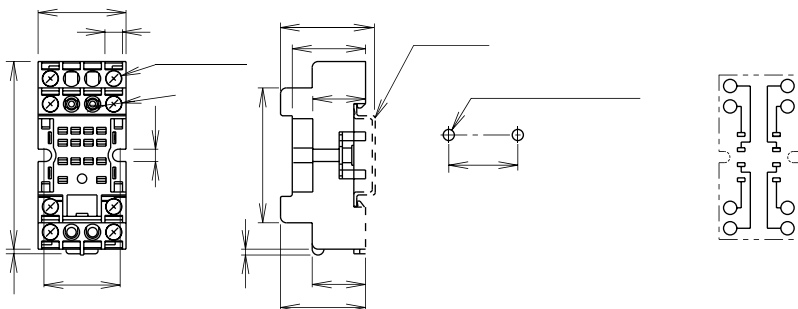

SM2S-05D

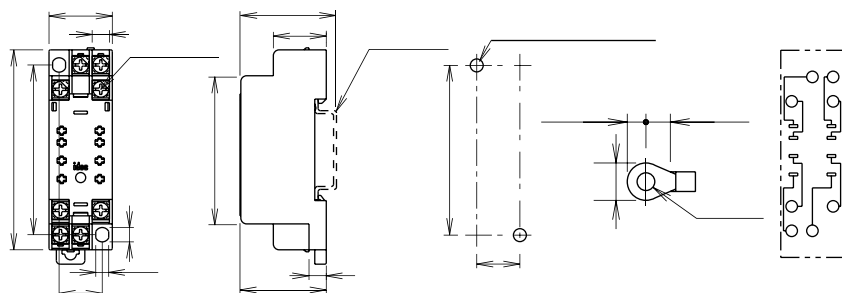

Relay Sockets

SM2S-05DF

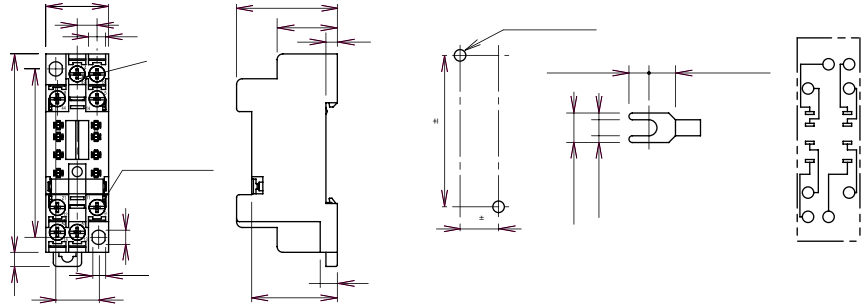

SY Series

SY2S-05A

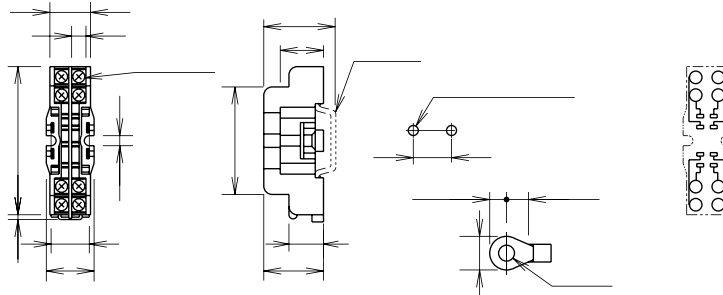

SY2S-05C

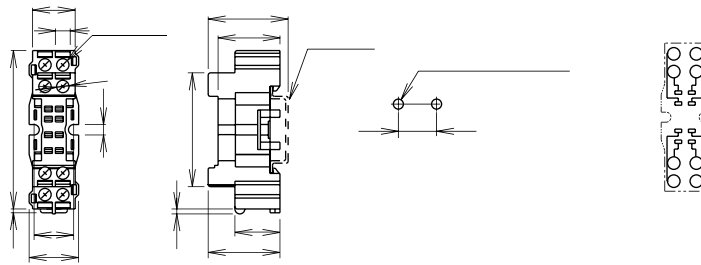

SY4S-05A

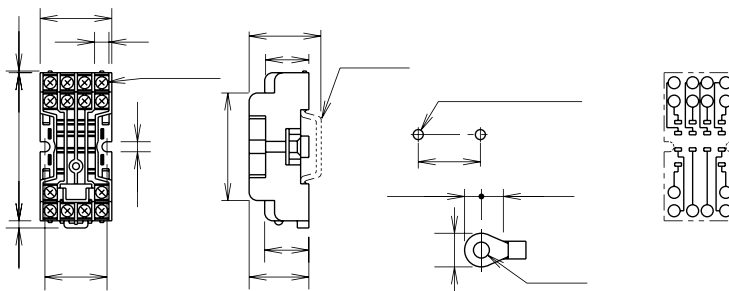

SY4S-05C

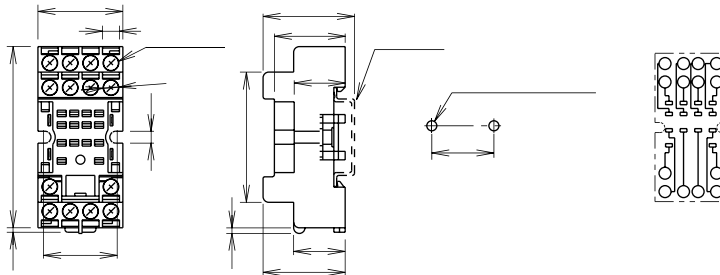

SY4S-05D

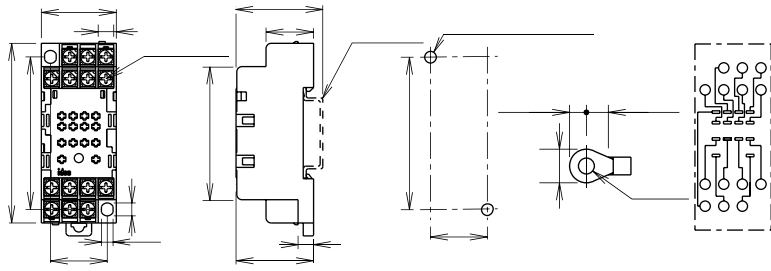

SY4S-05DF

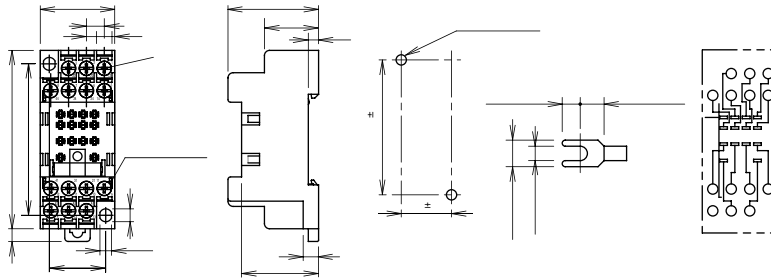

SU Series

SU2S-11L

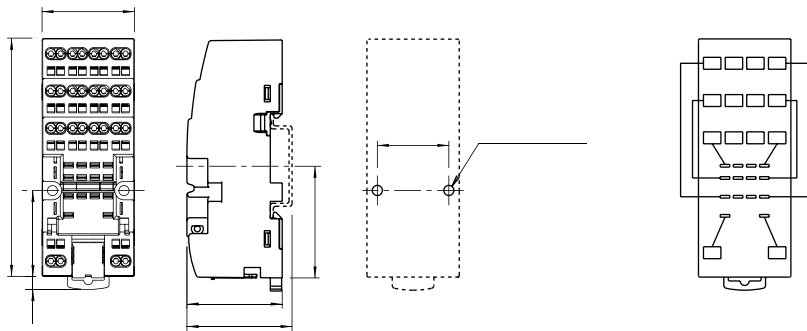
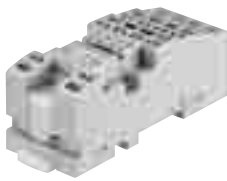

SU4S-11L

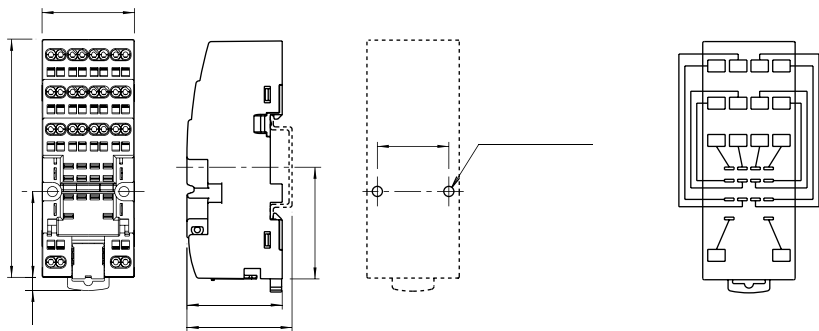
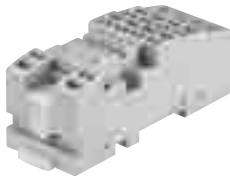

SH Series

SH1B-05A

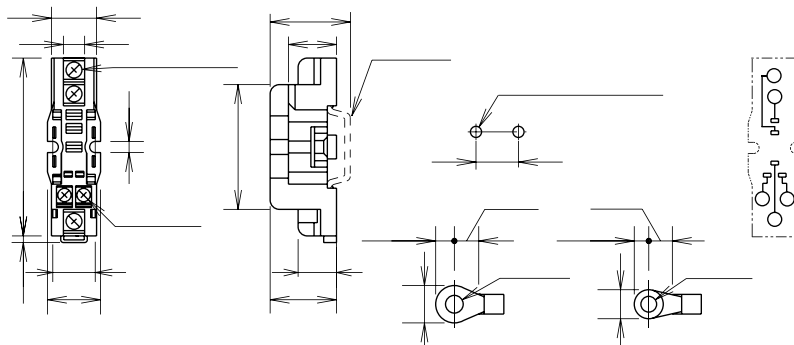

Relay Sockets

SH1B-05C

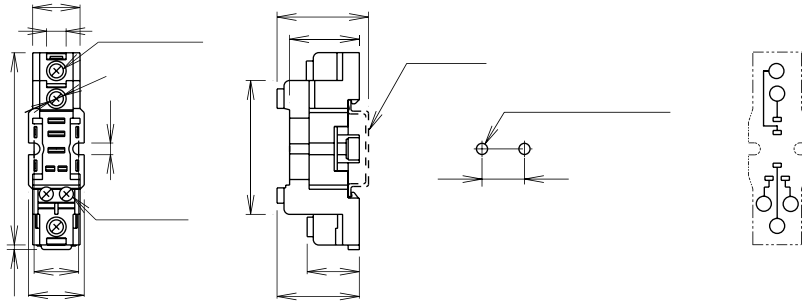

SH2B-05A

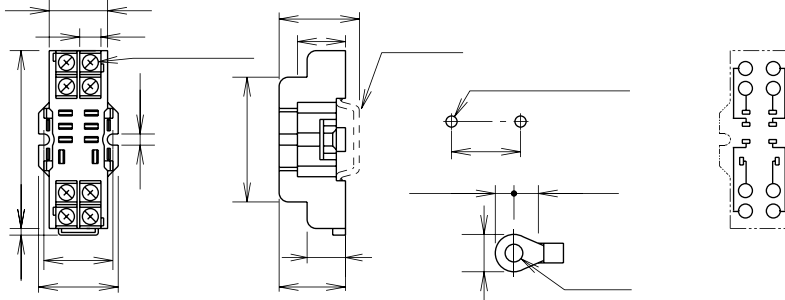

SH2B-05C

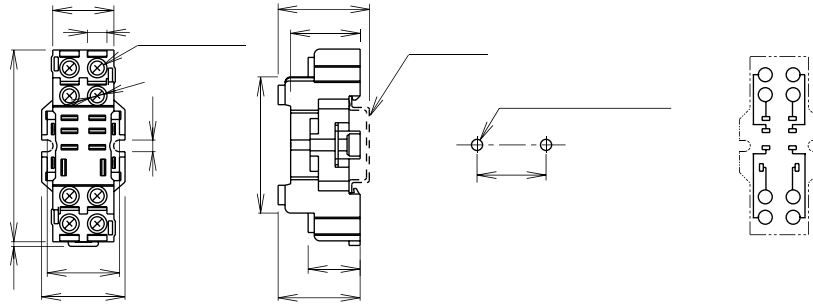

SH2B-05D

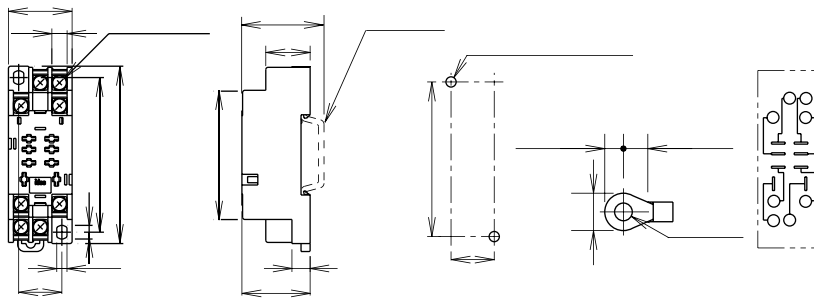

SH3B-05A

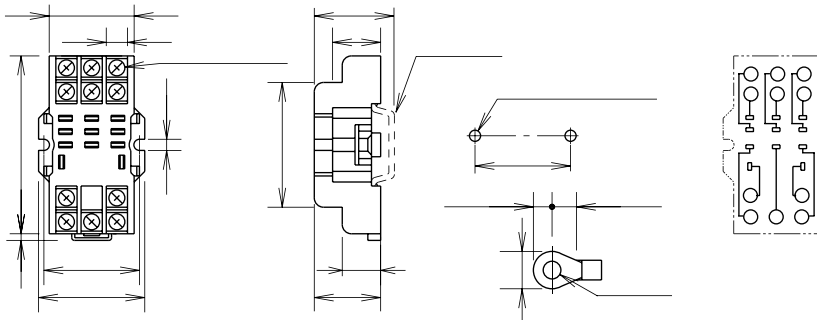

SH3B-05C

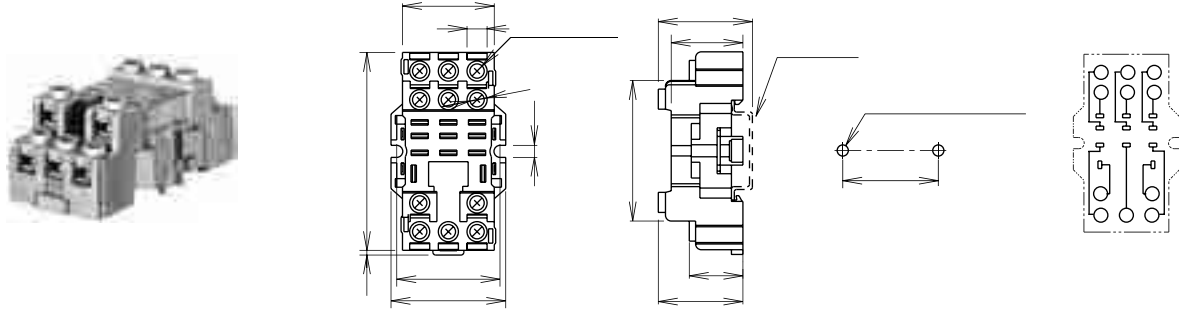

SH4B-05A

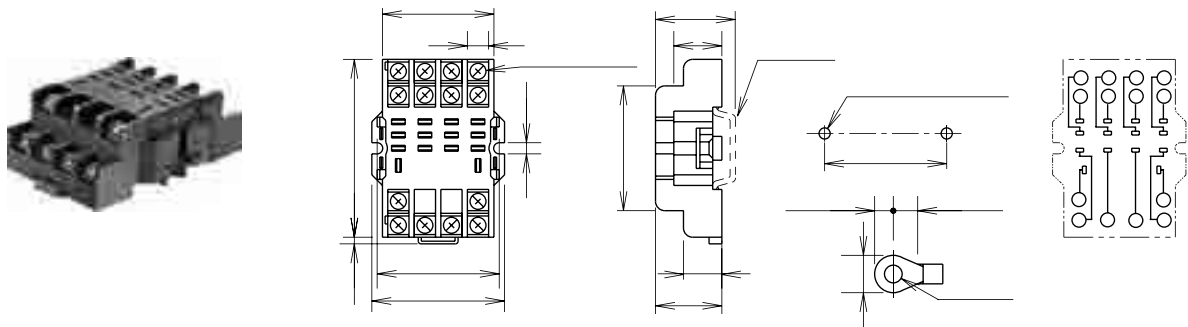

SH4B-05C

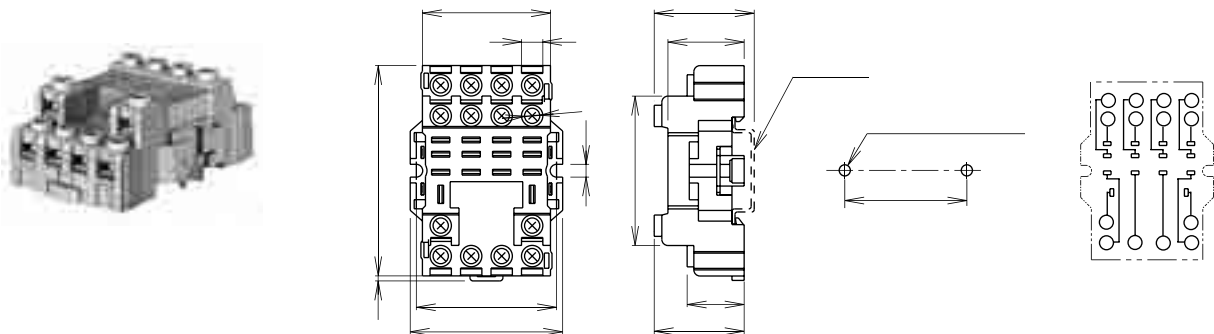

SR Series

SR2P-05A

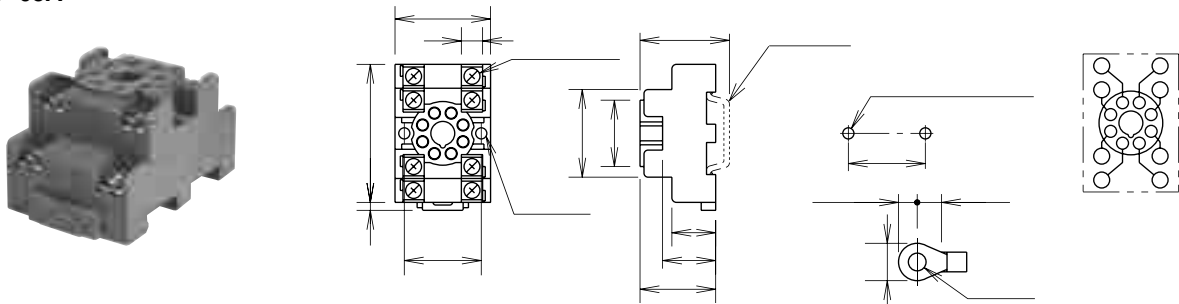

SR2P-05C

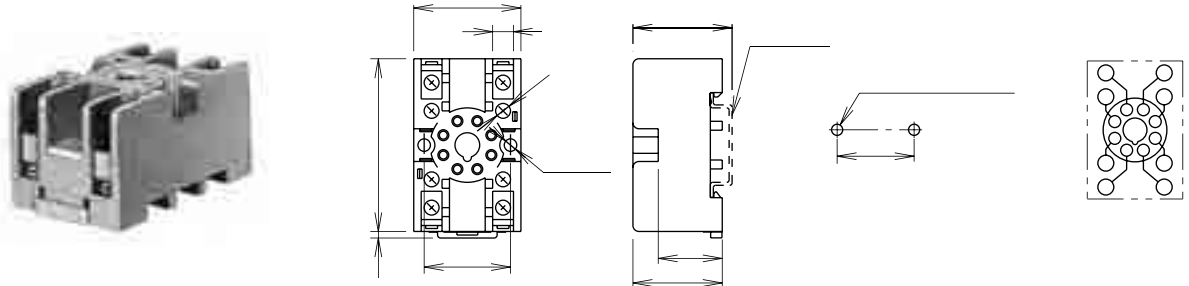

Relay Sockets

SR2P-06A

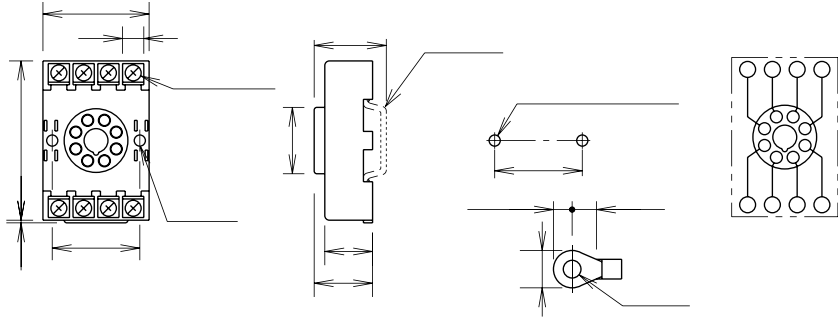

SR3P-05A

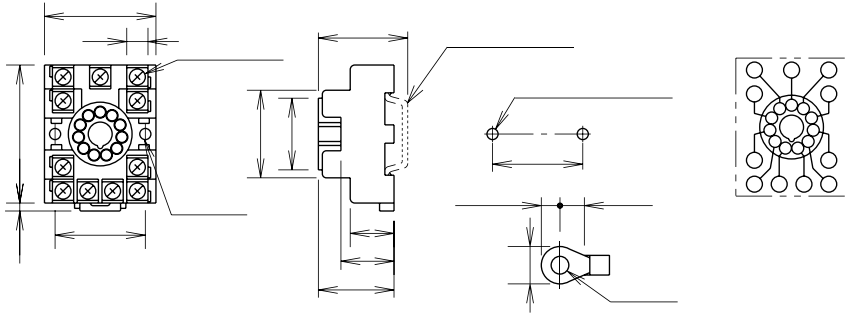

SR3P-05C

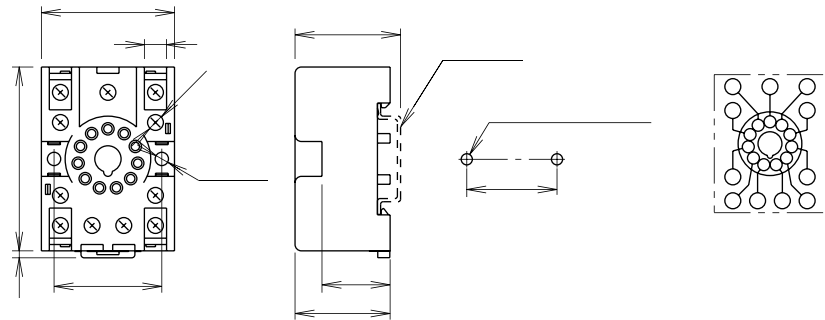

SR3P-06A

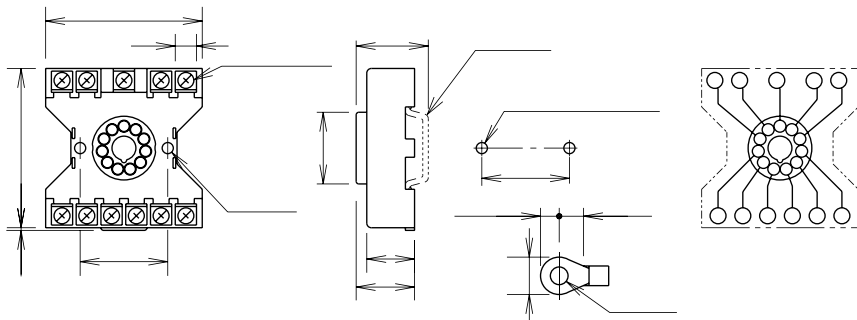

SR3B-05U

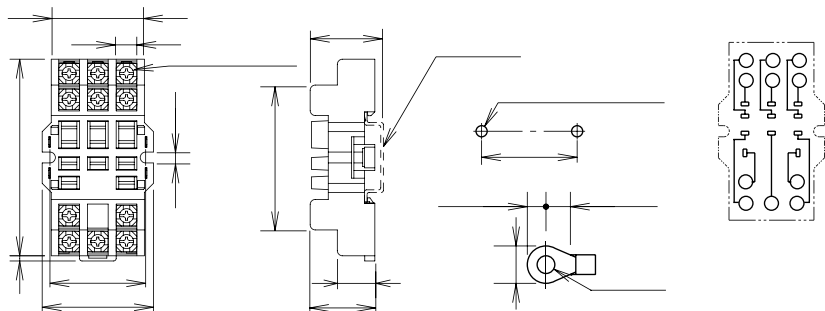

Panel Mount Sockets

SM Series

SM2S-51

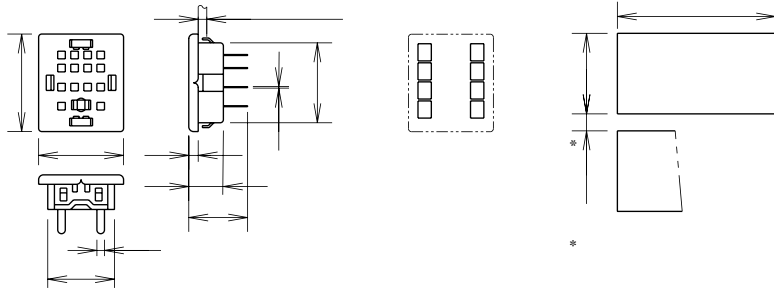

SY Series

SY2S-51

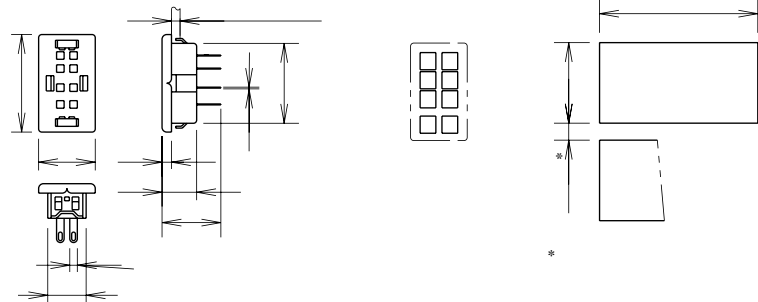

SY4S-51

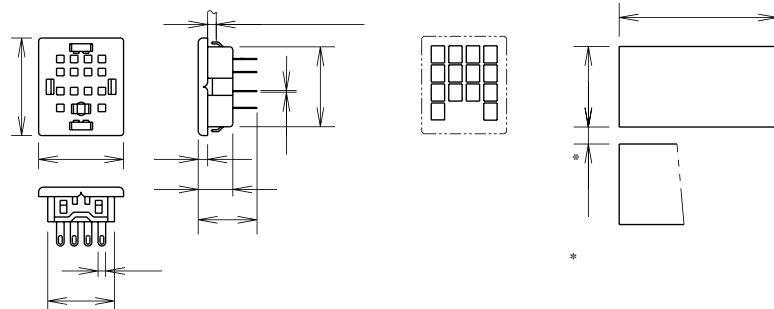

SH Series

SH1B-51

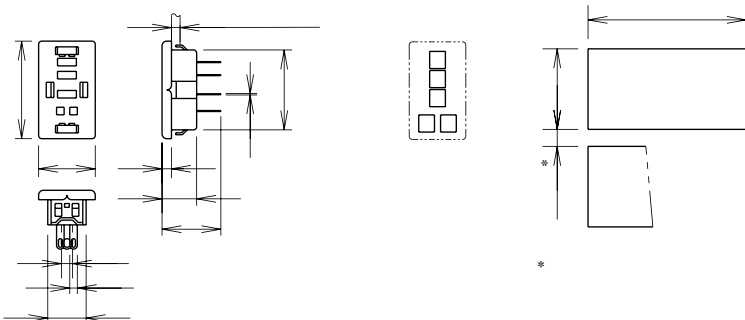

SH2B-51

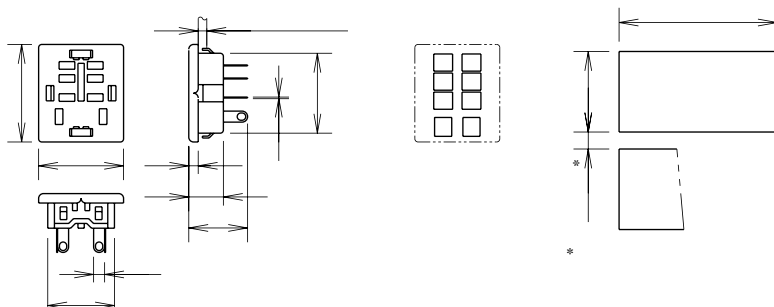

Relay Sockets

SH3B-51

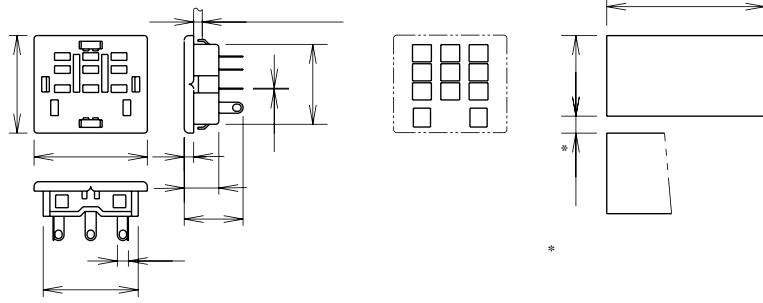

SH4B-51

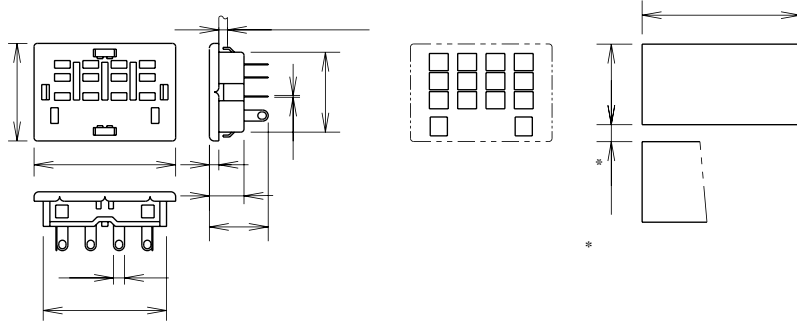

SR Series

SR2P-511

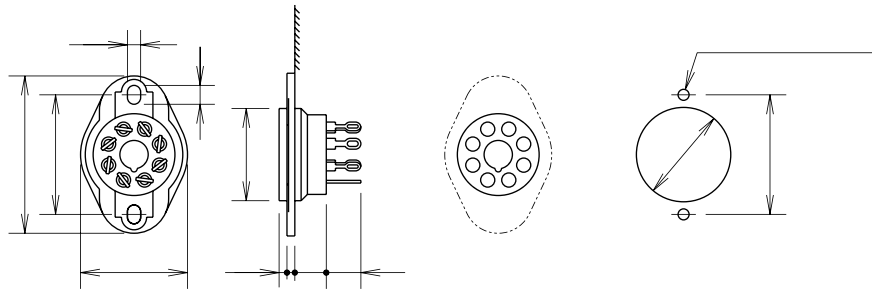

SR2P-70

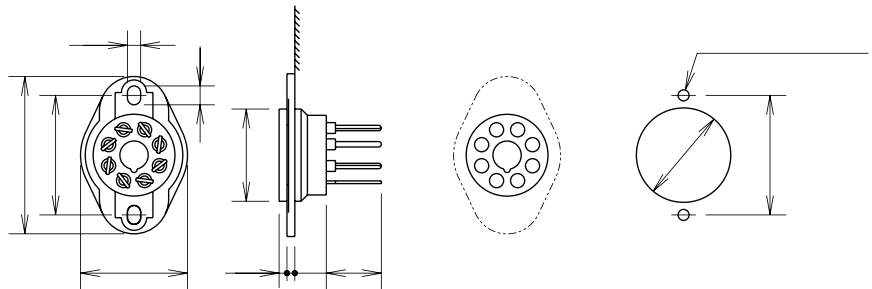

SR3P-511

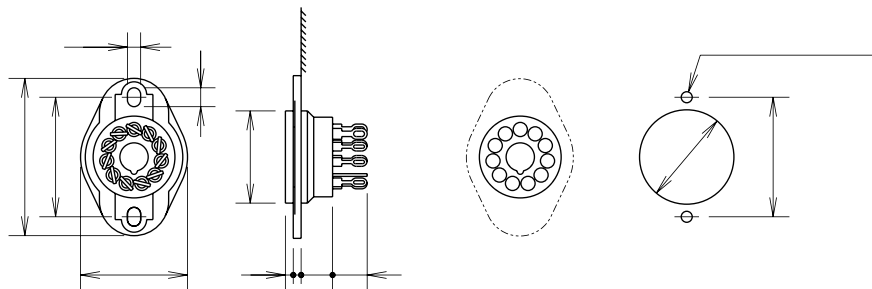

SR3P-70

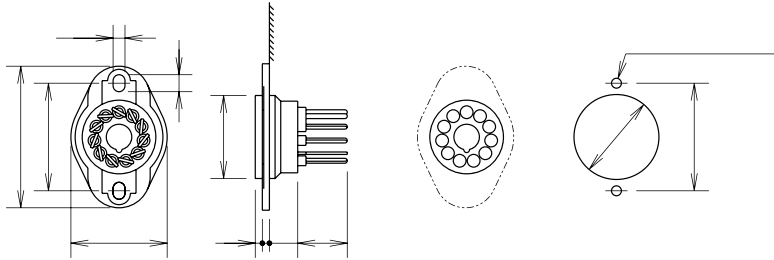

SR3B-51

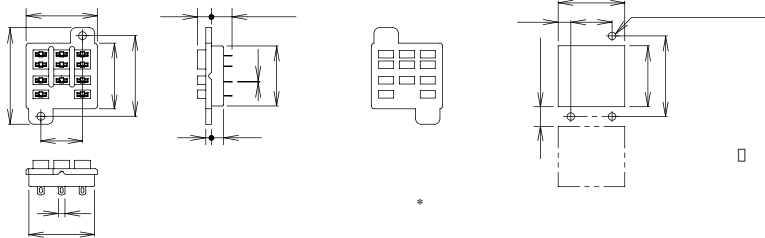

PC Board Mount Sockets

SM Series

SM2S-61

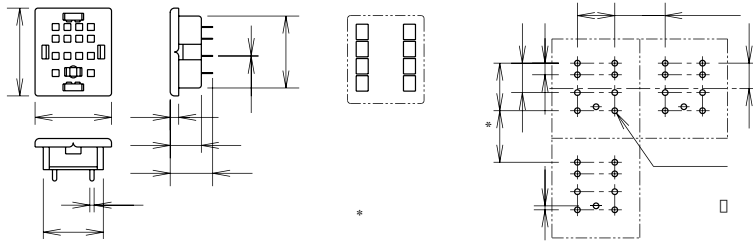

SM2S-62

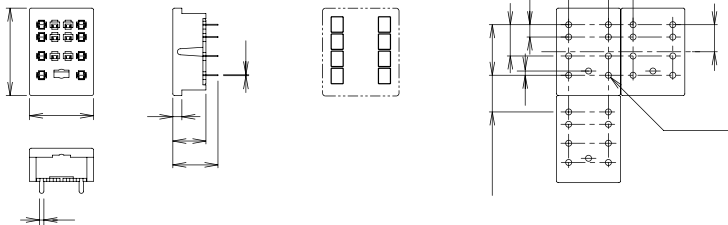
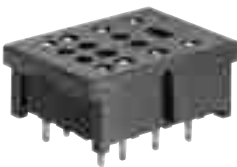

SY Series

SY2S-61

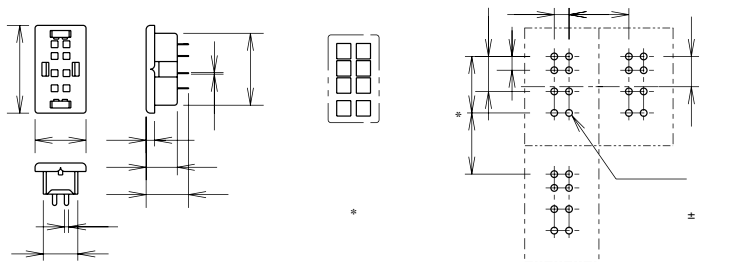

SY4S-61

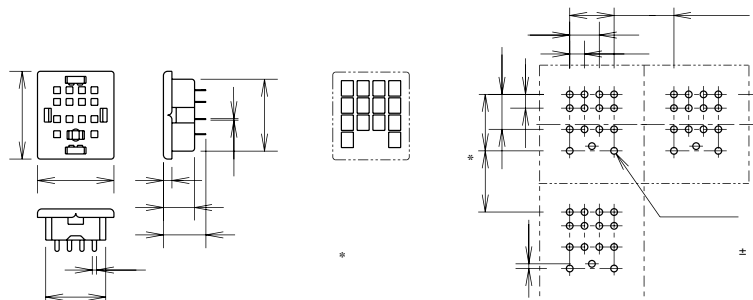

Relay Sockets

SY4S-62

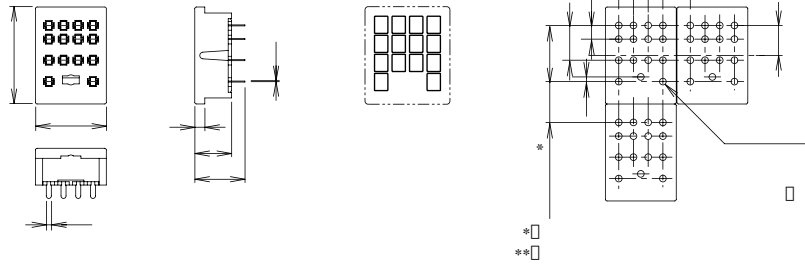

SH Series

SH1B-62

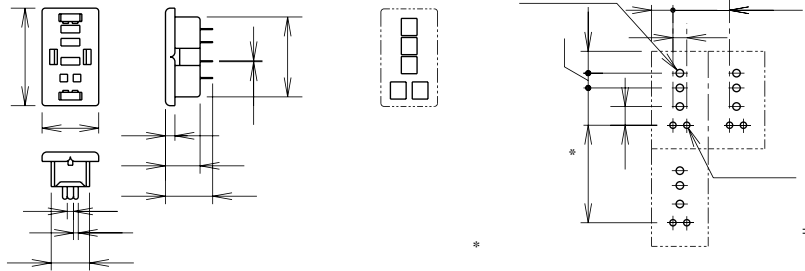

SH2B-62

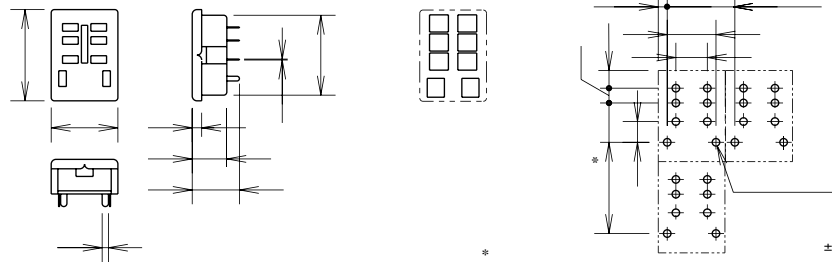

SH3B-62

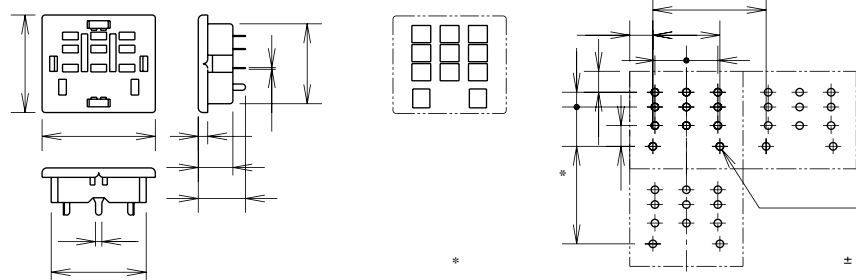

SH4B-62

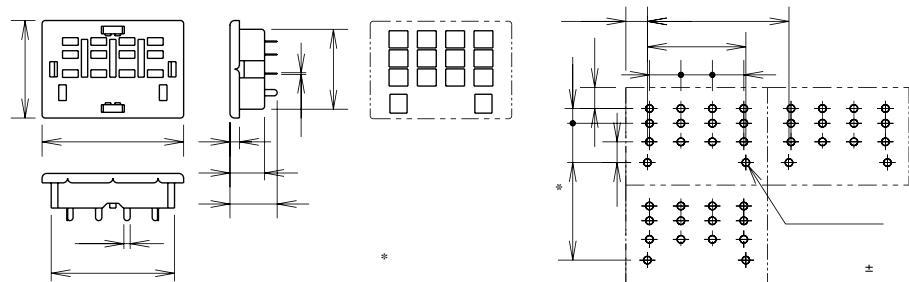

Accessories

DIN Rails

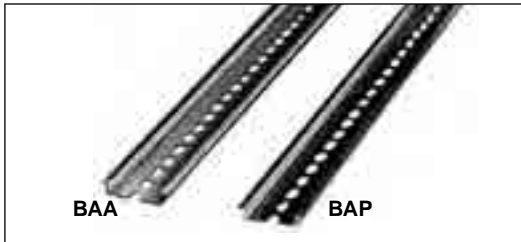

Material	Part No.	Ordering No.	Package Quantity
Aluminum	BAA1000	BAA1000PN10	10
Steel	BAP1000	BAP1000PN10	10

BAA/BAP

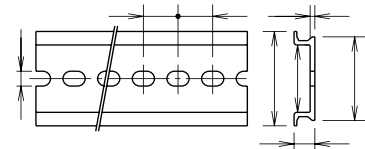

The BAA is a 35-mm-wide DIN rail made of durable extruded aluminum.
The BAP is a 35-mm-wide DIN rail made of rust proof sheet steel.

End Clip

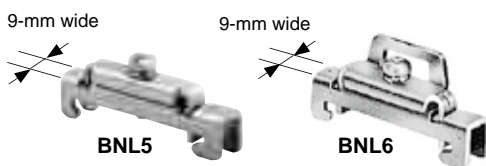

Application Example of End Clip and DIN Rail Spacer

Use DIN rail spacers for adding space between adjoining sockets to prevent miswiring and identify wiring groups.

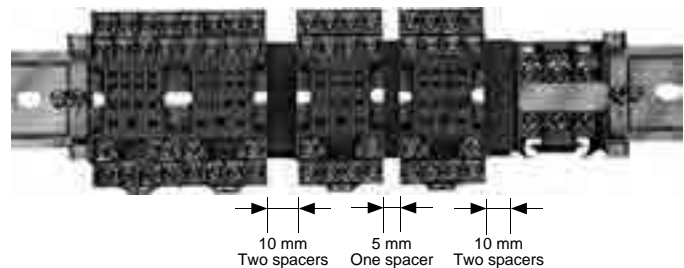

Use of the BNL5 or BNL6 end clip is recommended at the both ends of the socket row mounted on the DIN rail to prevent the sockets from moving sideways.

Part No.	Ordering No.	Package Quantity
BNL5	BNL5PN10	10
BNL6	BNL6PN10	10

Installation of End Clip and DIN Rail Spacer

DIN Rail Spacer



Spacers of 5-mm thick are designed to provide spacing between DIN rail mount sockets when mounted on 35-mm wide DIN rails. The spacers snap on and off the rail like sockets.

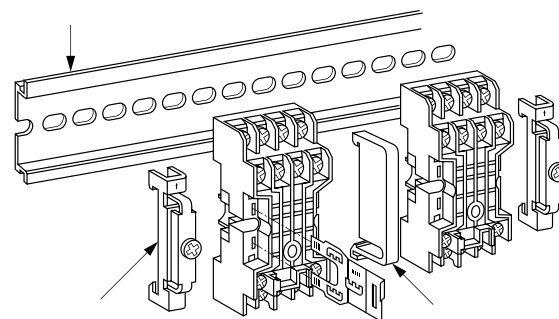

Part No.	Package Quantity	Color
SA-406B	1	Black

Surface Mounting of DIN Rail Mount Socket

End Spacer



Part No.	Package Quantity	Color
SA-203B	1	Black

Intermediate Spacer



Part No.	Package Quantity	Color
SA-204B	1	Black

The end spacer and intermediate spacer are used for mounting DIN rail mount sockets on panel surfaces. In collective mounting using these spacers, screws can be eliminated at every other socket. Mounting centers are the same in single mounting and collective mounting.

Note: DIN rail mount sockets can also mount directly on panel surfaces without using these spacers, then the mounting centers are different from when using spacers.

Relay Sockets

Collective Mounting

Single Mounting For saving the need for screw tightening and drilling

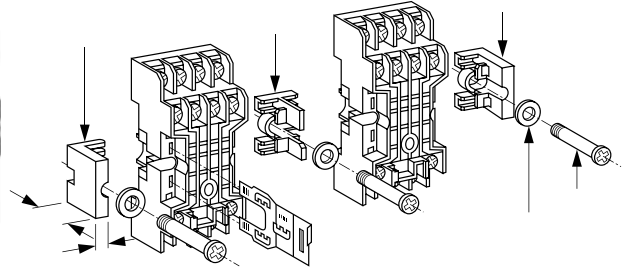
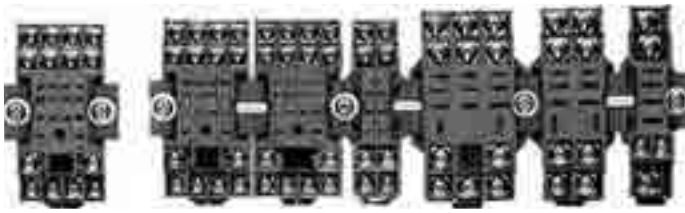

	Socket	A (mm)
	SR3B-05A	44
	SH1B-05A	21
	SH2B-05A	31
	SH3B-05A	41
	SH4B-05A	51
	SM2S-05A	31
	SY2S-05A	21
	SY4S-05A	31

Collective Mounting of Panel Mount Sockets

The SY, SM, and SH series panel mount sockets are designed to mount in panel cut-outs collectively. These sockets can be mounted in the same panel cut-out due to the standardized size.

Mounting into Panel Cut-out

To mount, insert the sockets with mounting springs facing top and bottom edges of the panel cut-out. Push the mounting spring using a screwdriver until the mounting spring clicks into the panel.

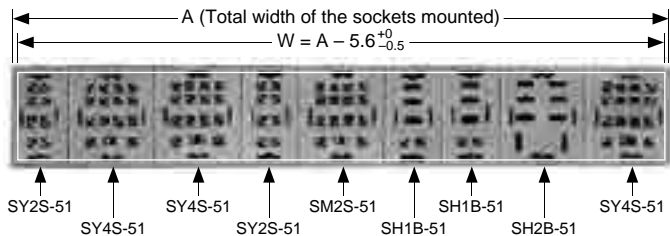
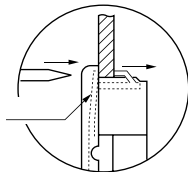

$$\begin{aligned} \text{Panel cut-out width } W &= 18 + 27 + 27 + 18 + 27 + 18 + 18 + 27 + 27 - 5.6 \\ &= 201.4^{+0}_{-0.5} \end{aligned}$$

Socket Width

Socket	Width
SH1B-51	18 mm
SH2B-51	27 mm
SH3B-51	36 mm
SH4B-51	45 mm
SM2S-51	27 mm
SY2S-51	18 mm
SY4S-51	27 mm

Soldering

When soldering, use a soldering iron of 60W (350°C), and quickly complete soldering within approximately 3 seconds. Sn-Ag-Cu is recommended for lead-free soldering. Ensure to keep the solder away from the socket as much as possible. Do not apply external force by bending the terminal or pulling the wire.



IDEC CORPORATION