

AP Series / UP Series Miniature Pilot Lights











UZ Series Miniature Buzzer





Pilot Light / Buzzer Selection Guide

Series	AP Series Miniature Pilot Lights				AP6S Series Miniature Pilot Lights
Mounting Hole Size	ø16	ø12	ø10	ø8	ø16
Type	AP6M	AP2M	AP1M	AP8M	AP6MS / AP6QS / AP6HS
Appearance					
Unit	Dome Flat	Dome Flat	Dome Flat	Dome Flat	Round, Square, Rectangular, Rectangular 3-sided barrier
Bezel Size	ø18	ø14	ø12	ø9.8	 (AP6MS) (AP6QS) (AP6HS, AP6GS)
Bezel Color	Black				Black
Light Source	Built-in LED				LED lamp (IDEC LSTD)
Illumination Color	Amber, Green, Red, White, Yellow		Amber, Green, Pure White, Red, Blue, White, Yellow		Amber, Green, Red, Blue, White, Yellow
Rated Voltage	6V, 12V, 24V DC		5V DC 12V, 24V AC/DC		6V, 12V, 24V AC/DC
Degree of Protection	Waterproof, oiltight (IP65)			Enclosed type (IP40)	Waterproof (IP65)
Terminal Style	Solder terminal				Screw terminal (M2.6) Solder/tab terminal #110
Notes	<ul style="list-style-type: none"> • 100/110V AC, 200/220V AC adapter available. • 110V DC (90V to 140V DC) DC-DC converter units available. • Flashing units (12/24V DC) available. • Built-in current limiting resistor and protection diode. • Marking is available on flat lens. 		<ul style="list-style-type: none"> • Built-in current limiting resistor and protection diode. • Marking is available on flat lens (except ø8). • Waterproof type (degree of protection IP65) available (except ø8). 		<ul style="list-style-type: none"> • Built-in BA9S base LED lamp. • Built-in current limiting resistor and protection diode in LED lamp. • Screw terminals and solder/tab terminals available.
Approvals					—
Page	5	6	7	8	11

Pilot Light / Buzzer Selection Guide

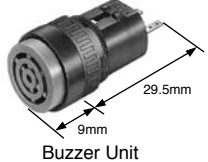
UP Series Miniature Pilot Lights					
ø10	ø9	ø8	ø7	ø6	
UP1 / UP1P	UP9 / UP9P	UP8	UP7	UP06	
					
6 types	6 types	6 types	6 types	3 types	
					
Chrome-plated (Metal)					
Built-in LED					
Amber, Green, Red, White, Yellow					
Without a built-in current limiting resistor With a built-in current limiting resistor (24V DC)				Without a built-in current limiting resistor only	
Enclosed type (IP40) Waterproof, oiltight (IP65)		Enclosed type (IP40)			
Solder terminal		Solder terminal			
<ul style="list-style-type: none"> • LED miniature pilot lights available with current limiting resistor (except ø6). • Waterproof (degree of protection IP65) (ø10 and ø9) • Single board mounting applicable types also available (except ø7 and ø6). 					
16, 21	17, 21	18, 21	19	19	

Series	UZ series Miniature Buzzer
Mounting Hole Size	ø16
Type	UZ6
Appearance	 <p>Buzzer Unit</p>  <p>Cyclical Sound Adapter (for pulsing sound)</p>
Unit	Buzzer unit Continuous sound
Bezel Size	
Bezel Color	Black (buzzer unit: blue)
Rated Voltage	12/24V DC Cyclical sound adapter 12/24V DC
Sound Pressure and Frequency	75 dB (at 1m) at rated voltage, 3.5 kHz ±800 Hz
Sound Cycle	Adjustable between 30 to 600 cycles per minute (period 2 to 0.1 sec)
Degree of Protection	Enclosure type (IP40) (Buzzer unit)
Terminal Style	Solder terminal (cyclical sound adapter screw terminal M8)
Notes	<ul style="list-style-type: none"> • Same size and same terminal arrangement as AP6M series miniature pilot lights. • The intermittent sound adapter can be snapped on to the back of the buzzer unit. <div style="border: 1px solid black; padding: 5px; margin-top: 10px;"> <ul style="list-style-type: none"> • LA3Z buzzer (rectangular) also available. See L6 series Control Units catalog for details. </div>
Page	23

ø8·10·12·16 AP Series Miniature Pilot Lights

Super Bright LEDs with built-in current-limiting resistor and reverse polarity protection diode

- Space saving miniature style
- Long life
- Illumination colors: amber, blue, green, pure white, red, white, and yellow (blue and pure white available for AP8M and AP1M only)
- Marking is available on flat lens units. (except AP8M series)
- Built-in protection diode ensures a reverse withstand voltage of 100V.
- UL recognized and CSA certified

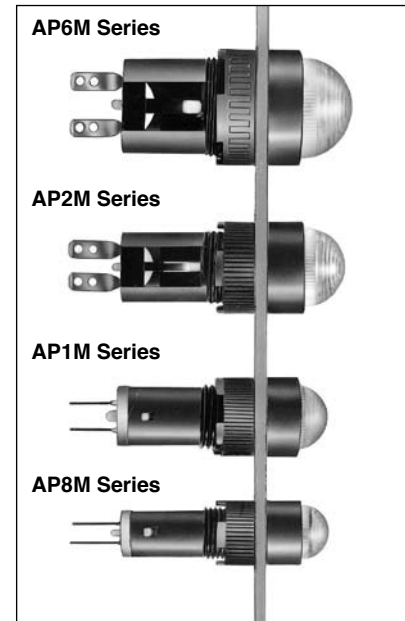
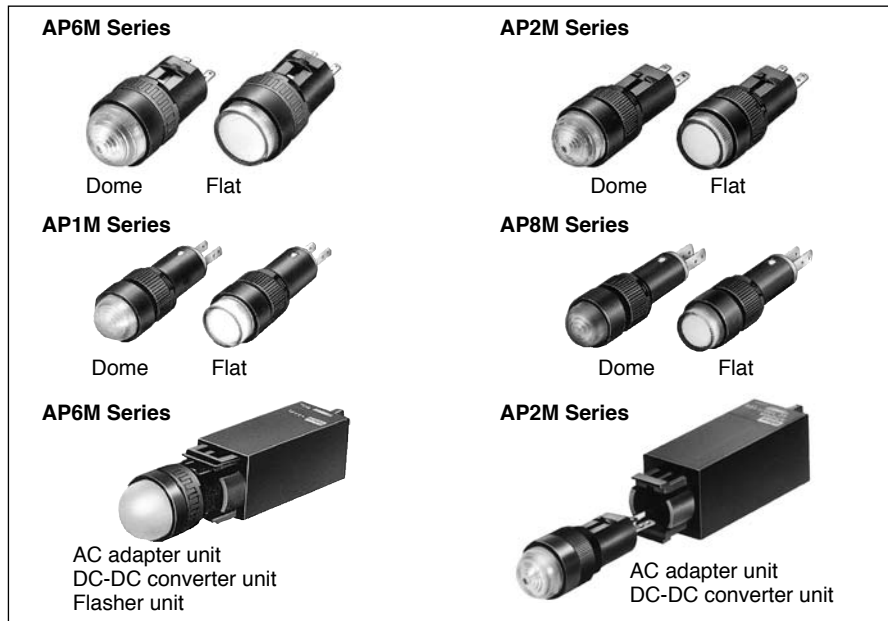

• Pilot Light

Input Type	Full voltage					
Operating Voltage	5V DC	6V DC	12V AC/DC	12V DC	24V AC/DC	24V DC
Rated Current	AP1M, AP8M: 9 mA (yellow: 15 mA)	AP6M, AP2M: 33 mA	AP1M, AP8M: 9 mA (yellow: 15 mA)	AP6M, AP2M: 22 mA	AP1M, AP8M: 9 mA (yellow: 15 mA)	AP6M, AP2M: 11 mA
Illumination Color Code	AP6M, AP2M: A (amber), G (green), R (red), Y (yellow), W (white) AP8M, AP1M: A (amber), G (green), PW (pure white), R (red), S (blue), Y (yellow), W (white)					
Operating Temperature	-20 to +55°C (no freezing)					
Operating Humidity	45 to 85% RH (no condensation)					
Insulation Resistance	Between live and dead parts: 100 MΩ minimum (500V DC megger)					
Dielectric Strength	Between live and dead parts: 1000V, 1 minute					
Reverse Withstand Voltage	100V		—	100V	—	100V
Solder Terminal	Soldering 350°C maximum (3 sec)					
Applicable Wire	ø1.0 or 0.75 mm ² maximum (20 to 16 AWG)					
Weight (approx.)	AP6M: 7.5g AP2M: 4.5g AP1M: 2.5g AP8M: 2.0g					
Degree of Protection	AP6M, AP2M, AP1M: IP65 AP8M: IP40 (according to IEC 60529)					





• AC Adapter/DC-DC Converter (Option)

Unit	AC Adapter	DC-DC Converter
Applicable Unit	AP6M and AP2M (6V rating only)	
Operating Voltage	100/110V AC, 200/220V AC 50/60 Hz	110V DC (90 to 140V DC)
Power Consumption	1.6 VA maximum	1W maximum
Insulation Voltage	250V AC	140V DC
Insulation Resistance	Between live and dead parts: 100 MΩ minimum (500V DC megger)	
Dielectric Strength	Between live and dead parts: 2000V, 1 minute	
	Between I/O terminals: 2000V AC, 1 minute	Between I/O terminals: 1500V AC, 1 minute
Terminal Style	M3 screw	
Weight (approx.)	38g	20g

• Flasher Unit (Option)

Applicable Unit	AP6M (12V and 24V DC rating only)
Operating Voltage	12/24V DC compatible ±10%
Flashing Period	Adjustable between approximately 30 to 600 cycles per minute (period 0.1 to 2 sec)
Current Draw	4 mA (OFF) to 6 mA (ON)
Terminal Style	M3 screw
Weight (approx.)	13.5g

AP6M Series (ø16)

Shape	Operating Voltage	Type No.	Ordering Type No.	Package Quantity	Lens Color Code
 	6V DC ±5%	AP6M266②	AP6M266②	1	Specify a lens color code in place of ② in the Type No. A: amber G: green R: red W: white Y: yellow
			AP6M266②PN10	10	
	12V DC ±10%	AP6M211②	AP6M211②	1	
			AP6M211②PN10	10	
	24V DC ±10%	AP6M222②	AP6M222②	1	
			AP6M222②PN10	10	
 	6V DC ±5%	AP6M166②	AP6M166②	1	
			AP6M166②PN10	10	
	12V DC ±10%	AP6M111②	AP6M111②	1	
			AP6M111②PN10	10	
	24V DC ±10%	AP6M122②	AP6M122②	1	
			AP6M122②PN10	10	

The LED cannot be removed. The lens can be removed and replaced.
 • Degree of protection: IP65

• **AC Adapter, DC-DC Converter, Flasher Unit**

Unit	Operating Voltage	Type No. (Ordering Type No.)	Applicable Pilot Light	Package Quantity
AC Adapter	100/110V AC	AP6-016D	AP6M266② (dome: 6V DC) AP6M166② (flat: 6V DC)	1
	200/220V AC	AP6-026D		
DC-DC Converter	110V DC (90 to 140V DC)	AP6-016DD		
Flasher Unit	12/24V DC	UZ6-F10	AP6M211② (dome: 12V DC) AP6M222② (dome: 24V DC) AP6M111② (flat: 12V DC) AP6M122② (flat: 24V DC)	

Dimensions / Panel Cut-out

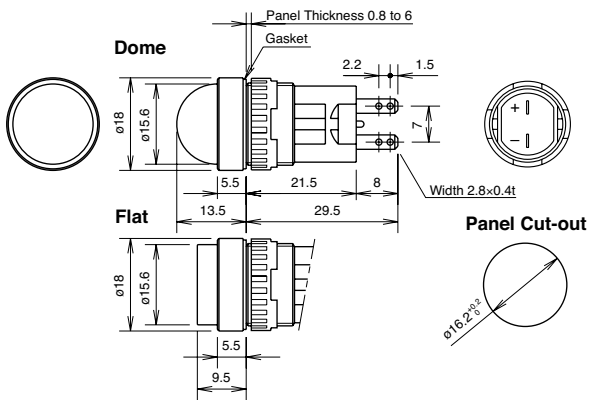

With AC Adapter, DC-DC Converter, or Flasher Unit

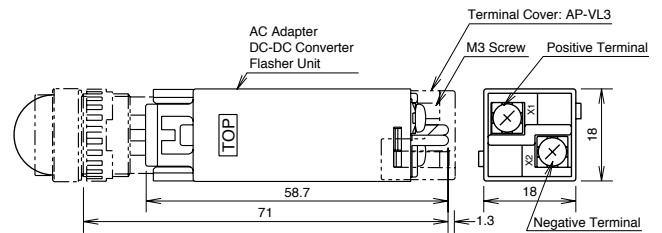

Terminal cover is not supplied.
 When using terminal covers, order AP-VL3 terminal covers.

Terminal Arrangement (Bottom View)

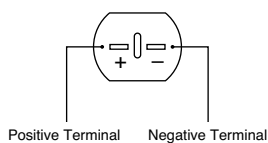

Marking Plate

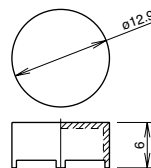

Engraving depth: 0.5 mm maximum
 Marking plate material: White acrylic

All dimensions in mm.

ø12 AP Series Miniature Pilot Lights

AP2M Series (ø12)

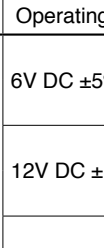
Shape	Operating Voltage	Type No.	Ordering Type No.	Package Quantity	Lens Color Code
	6V DC ±5%	AP2M266②	AP2M266②	1	Specify a lens color code in place of ② in the Type No. A: amber G: green R: red W: white Y: yellow
			AP2M266②PN10	10	
	12V DC ±10%	AP2M211②	AP2M211②	1	
			AP2M211②PN10	10	
	24V DC ±10%	AP2M222②	AP2M222②	1	
			AP2M222②PN10	10	
	6V DC ±5%	AP2M166②	AP2M166②	1	
			AP2M166②PN10	10	
	12V DC ±10%	AP2M111②	AP2M111②	1	
			AP2M111②PN10	10	
	24V DC ±10%	AP2M122②	AP2M122②	1	
			AP2M122②PN10	10	

- The LED cannot be removed. The lens can be removed and replaced.
- Degree of protection: IP65

• AC Adapter, DC-DC Converter

Unit	Operating Voltage	Type No.	Applicable Pilot Light	Package Quantity
AC Adapter	100/110V AC	AP2-016D	AP6M266② (dome: 6V DC) AP6M166② (flat: 6V DC)	1
	200/220V AC	AP2-026D		
DC-DC Converter	110V DC (90 to 140V DC)	AP2-016DD		

Dimensions / Panel Cut-out

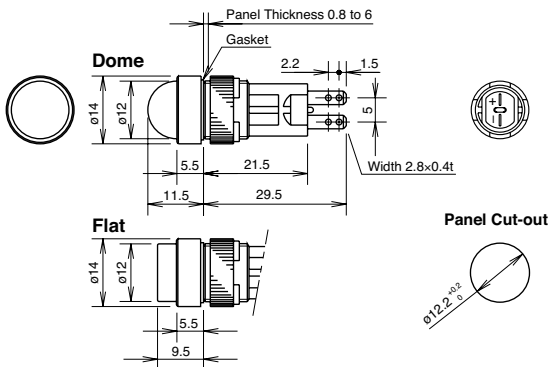

With AC Adapter or DC-DC Converter

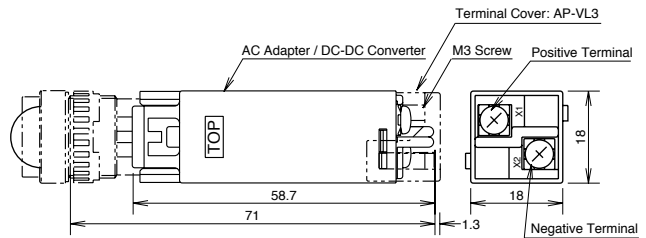

Terminal cover is not supplied.
When using terminal covers, order AP-VL3 terminal covers.

Terminal Arrangement (Bottom View)

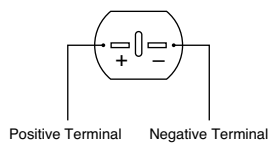



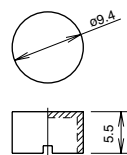

Marking Plate



Engraving depth: 0.5 mm maximum
Marking plate material: White acrylic

All dimensions in mm.

AP1M Series (ø10)					
Shape	Operating Voltage	Type No.	Ordering Type No.	Package Quantity	Lens Color Code
 	5V DC ±5%	AP1M255②	AP1M255②	1	Specify a lens color code in place of ② in the Type No. A: amber G: green PW: pure white R: red S: blue W: white Y: yellow
			AP1M255②PN10	10	
	12V AC/DC ±10%	AP1M211②	AP1M211②	1	
			AP1M211②PN10	10	
	24V AC/DC ±10%	AP1M222②	AP1M222②	1	
			AP1M222②PN10	10	
 	5V DC ±5%	AP1M155②	AP1M155②	1	
			AP1M155②PN10	10	
	12V AC/DC ±10%	AP1M111②	AP1M111②	1	
			AP1M111②PN10	10	
	24V AC/DC ±10%	AP1M122②	AP1M122②	1	
			AP1M122②PN10	10	

- The LED cannot be removed. The lens can be removed and replaced.
- Degree of protection: IP65

Dimensions / Panel Cut-out

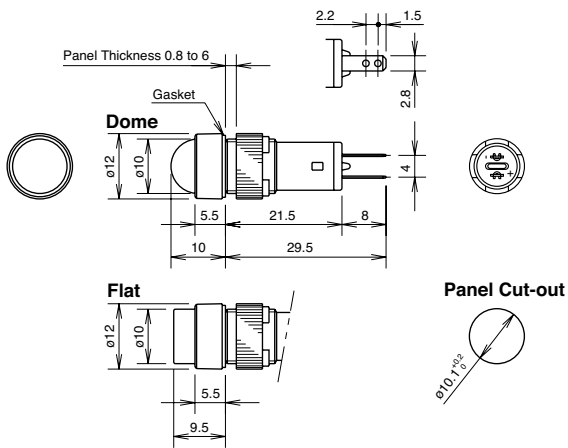

Terminal Arrangement (Bottom View)

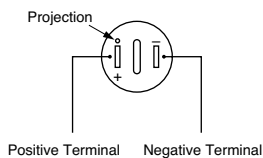

Marking Plate

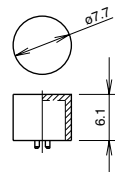



Engraving depth: 0.5 mm maximum
 Marking plate material: White acrylic

All dimensions in mm.

ø8 AP Series Miniature Pilot Lights

AP8M Series (ø8)

Shape	Operating Voltage	Type No.	Ordering Type No.	Package Quantity	Lens Color Code
	5V DC ±5%	AP8M255②	AP8M255②	1	Specify a lens color code in place of ② in the Type No. A: amber G: green PW: pure white R: red S: blue W: white Y: yellow
			AP8M255②PN10	10	
	12V AC/DC ±10%	AP8M211②	AP8M211②	1	
			AP8M211②PN10	10	
	24V AC/DC ±10%	AP8M222②	AP8M222②	1	
			AP8M222②PN10	10	
	5V DC ±5%	AP8M155②	AP8M155②	1	
			AP8M155②PN10	10	
	12V AC/DC ±10%	AP8M111②	AP8M111②	1	
			AP8M111②PN10	10	
	24V AC/DC ±10%	AP8M122②	AP8M122②	1	
			AP8M122②PN10	10	

- The lens or LED cannot be removed or replaced.
- Degree of protection: IP40

Dimensions / Panel Cut-out

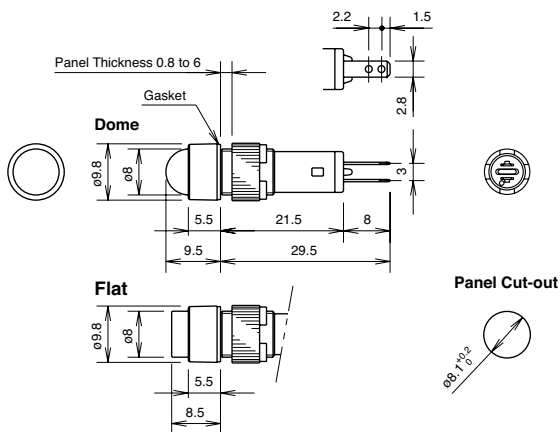



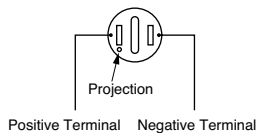

Terminal Arrangement (Bottom View)



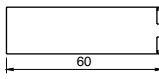

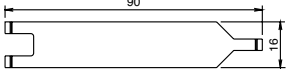

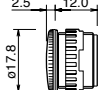
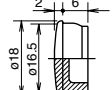
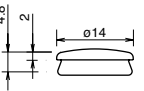
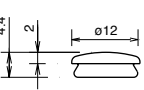
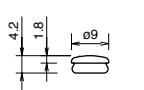
All dimensions in mm.

Accessories

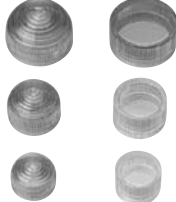
Shape	Type	Material	Type No.	Ordering Type No.	Package Quantity	Remarks										
	ø16	Metal (nickel-plated brass)	MT-001	MT-001	1	<ul style="list-style-type: none"> • Used to tighten the locking ring when installing an AP unit onto a panel. • Tighten the locking ring using a recommended tightening torque.  <table border="1" style="float: right;"> <thead> <tr> <th>Type No.</th> <th>Size</th> </tr> </thead> <tbody> <tr> <td>MT-001</td> <td>ø18</td> </tr> <tr> <td>MT-002</td> <td>ø14</td> </tr> <tr> <td>MT-003</td> <td>ø12</td> </tr> <tr> <td>MT-004</td> <td>ø9.5</td> </tr> </tbody> </table>	Type No.	Size	MT-001	ø18	MT-002	ø14	MT-003	ø12	MT-004	ø9.5
	Type No.		Size													
	MT-001		ø18													
	MT-002		ø14													
MT-003	ø12															
MT-004	ø9.5															
ø12	MT-002	MT-002	1													
ø10	MT-003	MT-003	1													
ø8	MT-004	MT-004	1													
		Stainless steel	MT-100	MT-100	1	<ul style="list-style-type: none"> • Used to remove the AC adapter, DC-DC converter, or flasher unit. 										
	ø16	Metal (diecast) Locking ring (plastic)	AL-BM6	AL-BM6	1	<ul style="list-style-type: none"> • Degree of protection: IP65 										
		Nitril rubber (black)	AL-B6	AL-B6PN05	5	<ul style="list-style-type: none"> • Degree of protection: IP65 										
	ø12	Nitril rubber (black)	AL-B2	AL-B2PN05	5	<ul style="list-style-type: none"> • Degree of protection: IP65 										
	ø10	Nitril rubber (black)	AL-B1	AL-B1PN05	5	<ul style="list-style-type: none"> • Degree of protection: IP65 										
	ø8	Nitril rubber (black)	AL-B8	AL-B8PN05	5	<ul style="list-style-type: none"> • Degree of protection: IP65 										

• Replacement Parts for AP6M/AP2M/AP1M

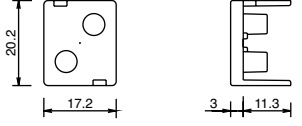
Shape	Type	Type No.	Ordering Type No.	Package Quantity	Lens Color Code	
	AP6M	Dome lens	AP6M-L2②	AP6M-L2②PN05	5	A (amber), G (green), R (red), W (white), Y (yellow) (Note 1)
		Flat lens	AP6M-L1②	AP6M-L1②PN05	5	A (amber), C (clear), G (green), R (red), Y (yellow) (Note 2)
	AP2M	Dome lens	AP2M-L2②	AP2M-L2②PN05	5	A (amber), G (green), R (red), W (white), Y (yellow) (Note 1)
		Flat lens	AP2M-L1②	AP2M-L1②PN05	5	A (amber), C (clear), G (green), R (red), Y (yellow) (Note 2)
	AP1M	Dome lens	AP1M-L2②	AP1M-L2②PN05	5	A (amber), G (green), R (red), S (blue), W (white), Y (yellow) (Note 1)
		Flat lens	AP1M-L1②	AP1M-L1②PN05	5	A (amber), C (clear), G (green), R (red), S (blue), Y (yellow) (Note 2)
	AP6M	Flat lens	AP6M-P1W	AP6M-P1WPN05	5	White
	AP2M		AP2M-P1W	AP2M-P1WPN05	5	
	AP1M		AP1M-PN1W	AP1M-PN1WPN05	5	
	AP1M	Dome lens	AP1M-PN2W	AP1M-PN2WPN05	5	White
	AP6M AP2M	AC adapter DC-DC converter Flasher unit	AP-VL3	AP-VL3	1	

Specify a lens color code in place of ② on the Ordering Type No.

Note 1: On the dome lens type, use a white (W) lens for white (W) illumination.

Note 2: On the flat lens type, use a clear (C) lens for white (W) illumination.

Safety Precautions

- Turn off power to the AP series pilot lights before installation, removal, wiring, maintenance, and inspection. Failure to turn power off may cause electrical shocks or fire hazard.
- For wiring, use wires of proper size to meet the voltage and current requirements. Improper wiring may cause overheating and

create a fire hazard. Tighten the M3 terminal screws to a torque of 0.6 to 1.0 N·m. Failure to tighten terminal screws may cause overheating and fire.

Instructions

• Panel Mounting

When mounting the AP series pilot lights on a panel, use the optional locking ring wrench. Do not use pliers. Excessive tightening will damage the locking ring.

Unit	Tightening Torque
AP6M	0.88 N·m
AP2M	0.78 N·m
AP1M	0.29 N·m
AP8M	0.29 N·m

• Installing the AC Adapter, DC-DC Converter, and Flasher Unit

1. Make sure that the voltage rating and terminal style of the AP series pilot lights are applicable to the AC adapter, DC-DC converter, and flasher units.
2. Install the pilot light into a panel cut-out before mounting an AC adapter, DC-DC converter, or flasher unit. Note that the pilot light cannot be installed in a panel cut-out with an AC adapter, DC-DC converter, or flasher unit mounted.
3. When installing an AC adapter, DC-DC converter, or flasher unit, make sure that the TOP marking is on the same side as the TOP marking of the pilot light. AC adapter, DC-DC converter, and flasher unit are snapped on to the back of the pilot light.
4. To remove the AC adapter or DC-DC converter, or flasher unit, insert the tip of the removal tool into the joint hook and pull towards you as shown in the photo below.

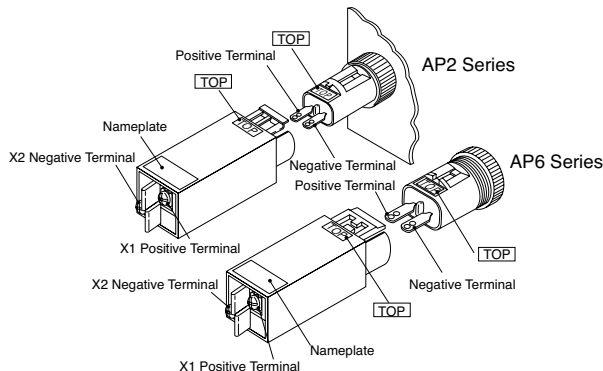
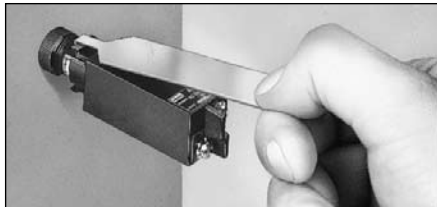

Note: Do not apply excessive force to terminals X1 and X2 during wiring.

5. When using an AC adapter or DC-DC converter, or flasher unit where the units are subjected to noise, connect a noise suppressor across terminals X1 and X2 as shown in the diagram below.

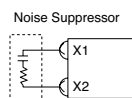

• Wiring

1. Note the positive and negative polarities when wiring.
2. All DC type AP series pilot lights contain a diode for protection against reverse polarity and a current limiting resistor, eliminating the need for external resistors.
3. Solder the terminal at 350°C within 3 seconds using a 60W soldering iron. SnAgCu type lead-free solder is recommended. When soldering, do not touch the pilot light housing with the soldering iron. Also ensure that no tensile force is applied to the terminal. Do not bend the terminal or apply excessive force to the terminal. Use a non-corrosive rosin flux.

• Marking

AP6M, AP2M, and AP1M round flat lenses contain a white marking plate inside the lens. (AP8M lens cannot be removed.)

• DC-DC Converter

DC-DC converters employ an electronic oscillating circuit. Oscillating sounds may be heard depending on operating conditions, but will not affect performance characteristics.

• Flasher Unit

Pierce the round mark on the nameplate on top of the flasher unit with a flat screwdriver and adjust the variable resistor inside. Turn clockwise to lengthen the flashing period.

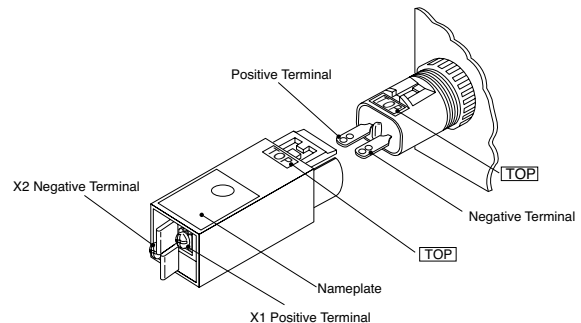

Note: Do not apply excessive force to terminals X1 and X2 during wiring.

AP6S Series Miniature Pilot Lights ø16

Miniature Pilot Lights with Super Bright LEDs



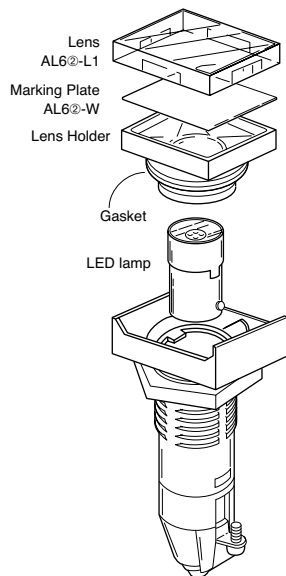

- IDEC's LSTD LED lamps with BA9S base
- Six illumination colors: amber, green, red, blue, white, and yellow
- Screw terminal and solder/tab terminal available
- Degree of protection: IP65
- The current-limiting resistor in the LED lamp eliminates the need for external resistors



Specifications

illumination	LED			
Operating Voltage	6V AC/DC, 12V AC/DC, 24V AC/DC			
Lens Color Code	A (amber), G (green), R (red), S (blue), W (white), Y (yellow)			
Built-in LED Lamp	LSTD			
LED Lamp Type No.	LSTD-6 ²	LSTD-1 ²	LSTD-2 ²	
Rated Voltage	6V AC/DC	12V AC/DC	24V AC/DC	
Current Draw	A, R, W	G, S, PW	A, G, R, PW, S, W	
	AC 8 mA	8 mA	11 mA	10 mA
	DC 7 mA	5.5 mA	10 mA	11 mA
LED Lamp Color Code	A (amber), G (green), PW (pure white), R (red), S (blue), W (white)			
Operating Temperature	-20°C to +50°C (no freezing)			
Operating Humidity	45 to 85% RH (no condensation)			
Insulation Resistance	Between live and dead metal parts: 100mΩ minimum (500V DC megger)			
Dielectric Strength	Between live and dead metal parts: 2000V AC, 1 minute			
Terminal Style	Screw terminal: M2.6 Tab terminal: #110 solder/tab terminal (applicable cable: 1.25 mm ² max.)			
Housing Material	Black plastic			
Degree of Protection	IP65 (waterproof/oiltight) (according to IEC 60529)			
Weight (approx.)	Terminal screw type: 18g Solder/tab screw type: 9g			

Types

Shape	Terminal Style	Operating Voltage	Type No. (Ordering Type No.)	Lens Color Code	Built-in LED (Type No.)
	Solder/Tab Terminal	6V AC/DC±5%	AP6MS52 ²	Specify a lens color code in place of ² in the Type No. A: amber G: green R: red S: blue W: white Y: yellow	LSTD-6 ²
		12V AC/DC±10%	AP6MS53 ²		LSTD-1 ²
		24V AC/DC±10%	AP6MS54 ²		LSTD-2 ²
	Screw Terminal	6V AC/DC±5%	AP6MS52M ²		LSTD-6 ²
		12V AC/DC±10%	AP6MS53M ²		LSTD-1 ²
		24V AC/DC±10%	AP6MS54M ²		LSTD-2 ²
	Solder/Tab Terminal	6V AC/DC±5%	AP6QS52 ²		LSTD-6 ²
		12V AC/DC±10%	AP6QS53 ²		LSTD-1 ²
		24V AC/DC±10%	AP6QS54 ²		LSTD-2 ²
	Screw Terminal	6V AC/DC±5%	AP6QS52M ²		LSTD-6 ²
		12V AC/DC±10%	AP6QS53M ²		LSTD-1 ²
		24V AC/DC±10%	AP6QS54M ²		LSTD-2 ²
	Solder/Tab Terminal	6V AC/DC±5%	AP6HS52 ²	LSTD-6 ²	
		12V AC/DC±10%	AP6HS53 ²	LSTD-1 ²	
		24V AC/DC±10%	AP6HS54 ²	LSTD-2 ²	
	Screw Terminal	6V AC/DC±5%	AP6HS52M ²	LSTD-6 ²	
		12V AC/DC±10%	AP6HS53M ²	LSTD-1 ²	
		24V AC/DC±10%	AP6HS54M ²	LSTD-2 ²	
	Solder/Tab Terminal	6V AC/DC±5%	AP6GS52 ²	LSTD-6 ²	
		12V AC/DC±10%	AP6GS53 ²	LSTD-1 ²	
		24V AC/DC±10%	AP6GS54 ²	LSTD-2 ²	
	Screw Terminal	6V AC/DC±5%	AP6GS52M ²	LSTD-6 ²	
		12V AC/DC±10%	AP6GS53M ²	LSTD-1 ²	
		24V AC/DC±10%	AP6GS54M ²	LSTD-2 ²	

ø16 AP6S Series Miniature Pilot Lights

Dimensions

• Screw Terminal

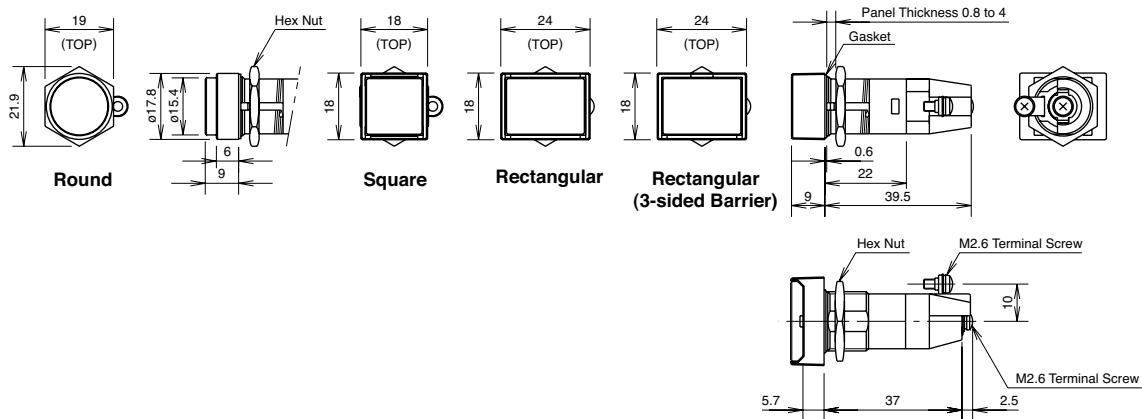

• Solder/Tab Screw Terminal

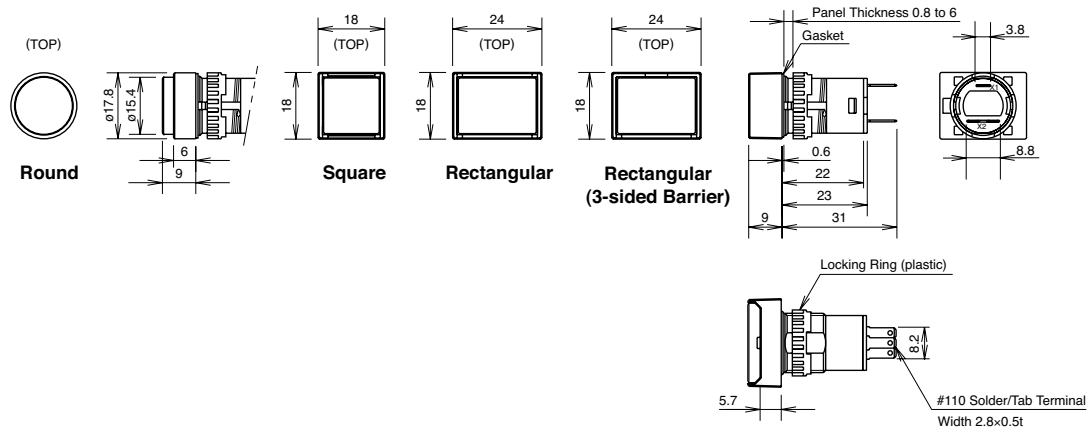

Mounting Hole Layout

All dimensions in mm.

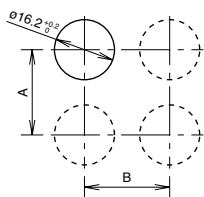

• Minimum Mounting Centers

	A		B	
	Round/Square	Rectangular	Round/Square	Rectangular
Screw Terminal	23 mm	23 mm	23 mm	24 mm
Tab Terminal	18 mm	18 mm	18 mm	24 mm

Terminal Arrangement (Bottom View)

• Screw Terminal

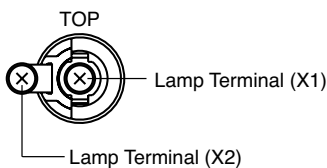

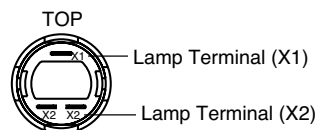

• Solder/Tab Terminal



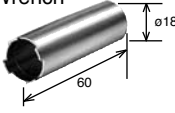

Accessories

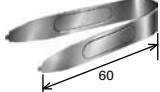
• **Tools**

Shape	Specification	Type No.	Ordering Type No.	Package Quantity	Remarks
	Metal (nickel-plated brass)	MT-001	MT-001	1	Used to tighten the locking ring when installing an AP6S unit onto a panel.
	Rubber	OR-55	OR-55	1	Used to install and remove LED lamps.
	Stainless Steel	MT-101	MT-101	1	Used to remove lens and buttons.

• **Replacement Parts for AP6M/AP2M/AP1M**

Shape	Type No.	Ordering Type No.	Package Quantity	Remarks	
	Round	AL6M-L②	AL6M-L②PN05	5	Specify a color code in place of ② in the Ordering Type No. A: amber C: clear G: green R: red S: blue Y: yellow Use a clear lens for white illumination.
	Square	AL6Q-L②	AL6Q-L②PN05	5	
	Rectangular Rectangular with 3-sided Barrier	AL6H-L②	AL6H-L②PN05	5	
	Round	AL6M-W	AL6M-WPN05	5	White
	Square	AL6Q-W	AL6Q-WPN05	5	
	Rectangular Rectangular with 3-sided Barrier	AL6H-W	AL6H-WPN05	5	

• **LED Lamps**

Operating Voltage	Current Draw		Type No.	Ordering Type No.	②Illumination Color Code	Package Quantity	Base
	AC	DC					
6V DC ±10%	8 mA	7 mA (A, R, W) 5.5 mA (G, PW, S)	LSTD-6②	LSTD-6②	Specify a color code in place of ② in the Ordering Type No. A: amber G: green PW: pure white R: red S: blue W: white	1	BA9S/13
				LSTD-6②PN10		10	
12V AC/DC ±10%	11 mA	10 mA	LSTD-1②	LSTD-1②	Use a pure white (PW) LED lamp with yellow (Y) lens.	1	
				LSTD-1②PN10		10	
24V AC/DC ±10%	11 mA	10 mA	LSTD-2②	LSTD-2②		1	
				LSTD-2②PN10		10	

ø16 AP6S Series Miniature Pilot Lights

Safety Precautions

- Turn off power to the AP6S series units before installation, removal, wiring, maintenance, and inspection. Failure to turn power off may cause electrical shocks or fire hazard.
- For wiring, use wires of proper size to meet the voltage and current requirements. Improper soldering may cause overheating and create fire hazards.

Instructions

Replacing Lens and Marking Plate

• Removal

Remove the operator (color lens, marking plate, and lens holder) by holding the color lens recesses with the Lens Removal Tool (MT-101) and pulling it out. Remove the marking plate by disengaging the latches between the color lens and lens holder. The marking plate must be engraved on the front side as shown below.

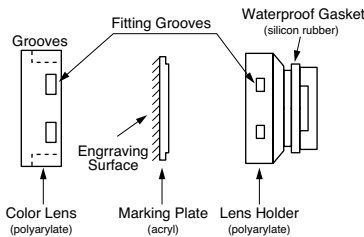

• Installation

Place the marking plate on the lens holder in the correct direction and press the color lens onto the lens holder to engage the latches. Insert the lens holder into the housing in the correct direction.

Marking Plate and Engraving Area

Engraving must be made on the engraving area less than 0.5mm deep.

Shape	Size	Engraving Area
Round	ø13.8 mm	ø12 mm
Square	13.8 mm	□12 mm
Rectangular	13.8×19.8 mm	12×18 mm

Notes on Mounting

• Screw Terminal

- Because screw terminal types use hexagonal nuts, they cannot be mounted closely together. However, rectangular units can be mounted closely when installed horizontally.
- When removing the hexagonal nuts, loosen the terminal screws. The hexagonal nuts cannot be removed when the terminal screws are tightened.

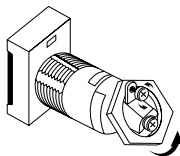

- When mounting the pilot lights collectively, note the mounting order. Pilot lights mounted in between units cannot be removed.

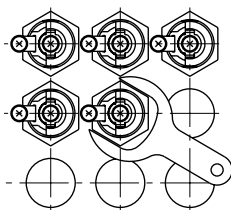

• Tab Terminal

The locking ring is plastic. To tighten the ring, use an optional locking ring wrench (MT-001). Do not use pliers. Do not tighten with excessive force, otherwise the locking ring will be damaged. Tightening torque should not exceed 0.88 N·m

• Collective Mounting and Continuous Illumination

Collective mounting or continuous illumination of pilot lights may cause the ambient temperature to rise above the rated operating temperature. Make sure to provide efficient ventilation when the mounting panel is not metallic or when the pilot lights are mounted collectively.

Wiring

Solder the terminal at 350°C within 3 seconds using a 60W soldering iron. SnAgCu type lead-free solder is recommended. When soldering, do not touch the pilot light housing with the soldering iron. Also ensure that no tensile force is applied to the terminal. Do not bend the terminal or apply excessive force to the terminal.

Power Supply for LED Lamps

The operating voltage of the LED lamp is within ±5% or ±10% of the rated voltage. Make sure that the power voltage is within this range.

Transformer

Separate Mounting Type	Primary Voltage	Secondary Voltage	Type No. (Ordering Type No.)	Applicable LED Lamp
	100/110V AC	24V AC, 0.5W	TWR512	LSTD-2②
	200/220V AC	24V AC, 0.5W	TWR522	
	400/440V AC	24V AC, 0.5W	TWR542	

- A dust cover is supplied with the separate mounting type transformer.
- Connect only one LSTD LED lamp to the separate mounting type transformer.
- Use plastic mounting clip BC9Z-E/NS35N when mounting 400/440V voltage models.

Specifications

Operating Voltage	100/110V AC, 200/220V AC 400/440V AC (50/60 Hz)
Power Consumption	2.4 VA
Rated Insulation Voltage	600V
Insulation Resistance	100 MΩ minimum (500V DC megger)
Operating Temperature	-30 to +60°C (no freezing)
Relative Humidity	35 to 85% (no condensation)
Vibration Resistance	Operating extremes: 5 to 55 Hz, amplitude 0.5 mm
Shock Resistance	Damage limits: 1,000 m/s ²
Dielectric Strength	2,500V AC, 1 minute
Terminal Style	M3.5
Applicable Wire	2 mm ² maximum, 2 wires maximum

Dimensions

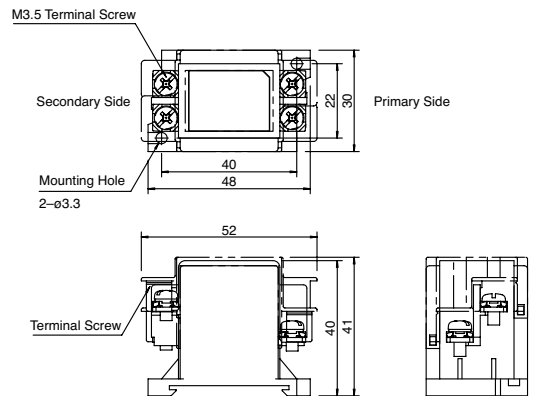

Accessories

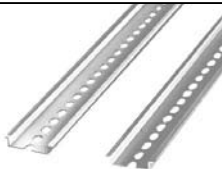
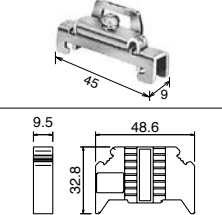
Description	Appearance	Description	Type No.	Ordering Type No.	Package Quantity
DIN Rail		Aluminum Weight: Approx. 200g Length: 1m	BAA1000	BAA1000PN10	10
		Steel Weight: Approx. 320g Length: 1m	BAP1000	BAP1000PN10	
Mounting Clip		Steel Weight: Approx. 15g	BNL6	BNL6PN10	
		Plastic Weight: Approx. 15g	BC9Z-E/NS35N	BC9Z-E/NS35NPN10	

- Use plastic mounting clip BC9Z/NS35N when using 400/440V AC voltage transformers.

ø6·7·8·9·10 UP Series Miniature Pilot Lights

Available in Various Sizes

- Five illumination colors: amber, green, red, white, yellow
- Various sizes and design.
- Available with a built-in current limiting resistor.
- Waterproof (IP65) types available for ø9 and ø10.
- Panel thickness 0.6 to 4 mm
(built-in current limiting resistor type 0.6 to 6 mm)

Specifications

• Without a Built-in Current Limiting Resistor

Color Code	A (amber), G (Green), Red (R), W (white), Y (yellow)
Rated Current	10 mA (Amber, Green, Red, Yellow) 15 mA (White)
Forward Current	20 mA maximum at 25°C
Reverse Voltage	3V maximum at 25°C
Power Consumption	60 mW maximum at 25°C
Operating Temperature	-20 to +55°C
Storage Temperature	-25 to +80°C
Forward Voltage	Maximum value: 3V Standard value: 2V (forward current: 10 mA)
Dielectric Strength	Between live and dead parts: 500V AC, 1 minute

• With a Built-in Current Limiting Resistor



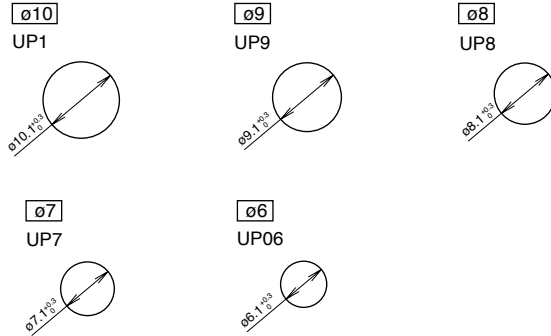

Color Code	A (amber), G (Green), Red (R), W (white), Y (yellow)
Operating Voltage	12V DC±10%, 24V DC±10%
Rated Current	15 mA
Operating Temperature	-20 to +55°C (no freezing)
Operating Humidity	45 to 85% RH (no condensation)
Dielectric Strength	Between live and dead parts: 500V AC, 1 minute

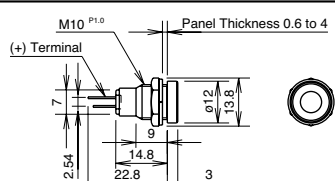

Weight (example)

Weight (approx.)	2g (UP06-67)
	5g (UP7-1277)
	6g (UP8-2487)
	7g (UP9-2497)
	8g (UP1-2417)

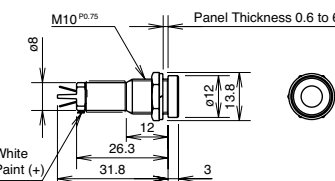

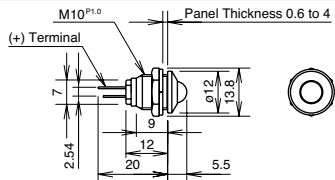
UP1 Series

Shape	Operating Voltage	Degree of Protection	Type No.	Ordering Type No.	Color Code	Dimensions (mm)	Package Quantity
 (+) o — — o (-)	—	IP40	UP1-17②	UP1-17②	Specify a color code in place of ② in the Type No. A: amber G: green R: red W: white Y: yellow		1
				UP1-17②PN10			10
		IP65 (Waterproof)	UP1P-17②	UP1P-17②			1
				UP1P-17②PN10			10
 (+) o — — o (-)	12V DC ±10%	IP40	UP1-1217②	UP1-1217②			1
				UP1-1217②PN10			10
		IP65 (Waterproof)	UP1P-1217②	UP1P-1217②			1
	UP1P-1217②PN10			10			
	24V DC ±10%	IP40	UP1-2417②	UP1-2417②	1		
				UP1-2417②PN10	10		
IP65 (Waterproof)		UP1P-2417②	UP1P-2417②	1			
	UP1P-2417②PN10		10				
 (+) o — — o (-)	—	IP40	UP1-18②	UP1-18②		1	
				UP1-18②PN10		10	
		IP65 (Waterproof)	UP1P-18②	UP1P-18②		1	
				UP1P-18②PN10		10	

Note: For UP series pilot lights without built-in current limiting resistors, connect an external resistor in series. Otherwise, the LED may be damaged.





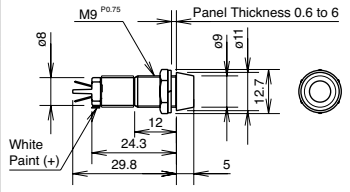



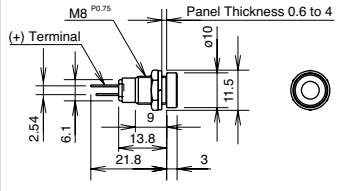

ø6·7·8·9·10 UP Series Miniature Pilot Lights

UP9 Series

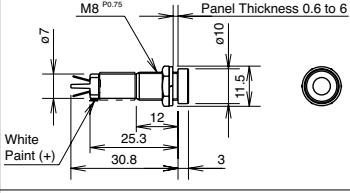
Shape	Operating Voltage	Degree of Protection	Type No.	Ordering Type No.	Color Code	Dimensions (mm)	Package Quantity
 <p>(+)  (-)</p>	12V DC ±10%	IP40	UP9-1299②	UP9-1299②	Specify a color code in place of ② in the Type No. A: amber G: green R: red W: white Y: yellow		1
				UP9-1299②PN10			10
		IP65 (Waterproof)	UP9P-1299②	UP9P-1299②			1
				UP9P-1299②PN10			10
	24V DC ±10%	IP40	UP9-2499②	UP9-2499②			1
				UP9-2499②PN10			10
		IP65 (Waterproof)	UP9P-2499②	UP9P-2499②			1
				UP9P-2499②PN10			10

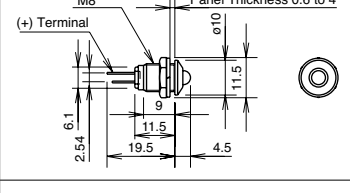
Note: For UP series pilot lights without built-in current limiting resistors, connect an external resistor in series. Otherwise, the LED may be damaged.

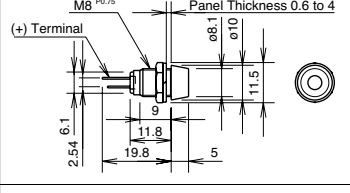

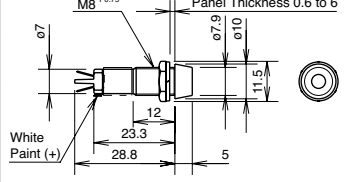



UP8 Series

Shape	Operating Voltage	Degree of Protection	Type No.	Ordering Type No.	Color Code	Dimensions (mm)	Package Quantity		
 <p>(+)  (-)</p>	—	IP40	UP8-87②	UP8-87②	Specify a color code in place of ② in the Type No. A: amber G: green R: red W: white Y: yellow		1		
				UP8-87②PN10			10		
 <p>(+)  (-)</p>	12V DC ±10%	IP40	UP8-1287②	UP8-1287②	Specify a color code in place of ② in the Type No. A: amber G: green R: red W: white Y: yellow		1		
				UP8-1287②PN10			10		
	24V DC ±10%			UP8-2487②			UP8-2487②	1	
							UP8-2487②PN10	10	
 <p>(+)  (-)</p>	—	IP40	UP8-88②	UP8-88②	Specify a color code in place of ② in the Type No. A: amber G: green R: red W: white Y: yellow		1		
				UP8-88②PN10			10		
				12V DC ±10%			UP8-1288②	UP8-1288②	1
								UP8-1288②PN10	10
24V DC ±10%	UP8-2488②	UP8-2488②	1						
		UP8-2488②PN10	10						
 <p>(+)  (-)</p>	—	IP40	UP8-89②	UP8-89②	Specify a color code in place of ② in the Type No. A: amber G: green R: red W: white Y: yellow		1		
				UP8-89②PN10			10		
 <p>(+)  (-)</p>	12V DC ±10%	IP40	UP8-1289②	UP8-1289②	Specify a color code in place of ② in the Type No. A: amber G: green R: red W: white Y: yellow		1		
				UP8-1289②PN10			10		
	24V DC ±10%			UP8-2489②			UP8-2489②	1	
							UP8-2489②PN10	10	

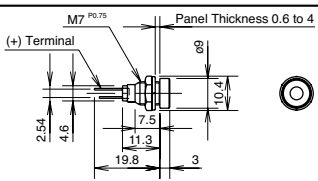
Note: For UP series pilot lights without built-in current limiting resistors, connect an external resistor in series. Otherwise, the LED may be damaged.

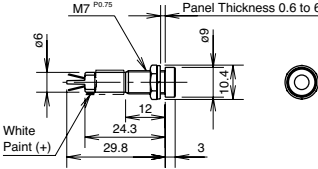

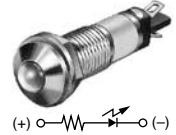
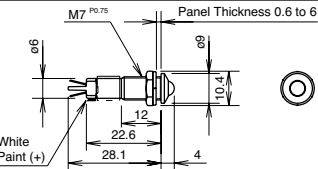

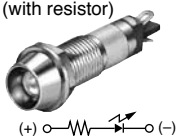
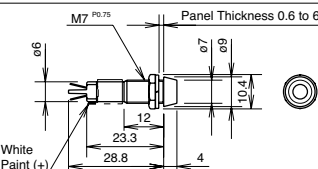
UP Series Miniature Pilot Lights 06·7·8·9·10

UP7 Series

Shape	Operating Voltage	Degree of Protection	Type No.	Ordering Type No.	Color Code	Dimensions	Package Quantity
 (+) ○ — — ○ (-)	—	IP40	UP7-77②	UP7-77②	Specify a color code in place of ② in the Type No. A: amber G: green R: red W: white Y: yellow		1
				UP7-77②PN10			10
 (+) ○ — — ○ (-)	12V DC ±10%		UP7-1277②	UP7-1277②			1
	24V DC ±10%			UP7-2477②			1
			UP7-2477②PN10	10			
	 (+) ○ — — ○ (-)			—			UP7-78②
UP7-78②PN10			10				
 (+) ○ — — ○ (-)	12V DC ±10%		UP7-1278②	UP7-1278②			1
	24V DC ±10%			UP7-2478②			1
			UP7-2478②PN10	10			
	 (+) ○ — — ○ (-)			—			UP7-79②
UP7-79②PN10			10				
 (+) ○ — — ○ (-)	12V DC ±10%	UP7-1279②	UP7-1279②		1		
	24V DC ±10%		UP7-2479②		1		
		UP7-2479②PN10	10				

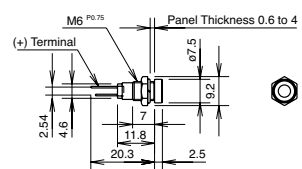
Note: For UP series pilot lights without built-in current limiting resistors, connect an external resistor in series. Otherwise, the LED may be damaged.

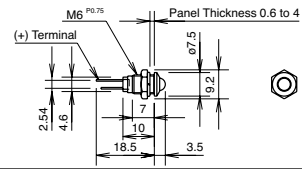
UP06 Series

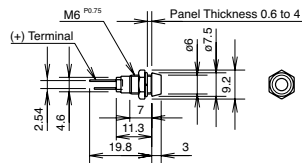
Shape	Operating Voltage	Degree of Protection	Type No.	Ordering Type No.	Color Code	Dimensions	Package Quantity
 (+) ○ — — ○ (-)	—	IP40	UP06-67②	UP06-67②	Specify a color code in place of ② in the Type No. A: amber G: green R: red W: white Y: yellow		1
				UP06-67②PN10			10
 (+) ○ — — ○ (-)	—		UP06-68②	UP06-68②			1
				UP06-68②PN10			10
 (+) ○ — — ○ (-)	—		UP06-69②	UP06-69②			1
				UP06-69②PN10			10

Note: For UP series pilot lights without built-in current limiting resistors, connect an external resistor in series. Otherwise, the LED may be damaged.

ø6·7·8·9·10 UP Series Miniature Pilot Lights

Instructions

• Polarity

Pay attention to the polarity of the power supply as UP series units do not contain a diode for protection against reverse polarity. On solder terminal units, the terminal with a white paint marking is positive. On wire-wrap terminal units, the long terminal is positive and the short terminal is negative.

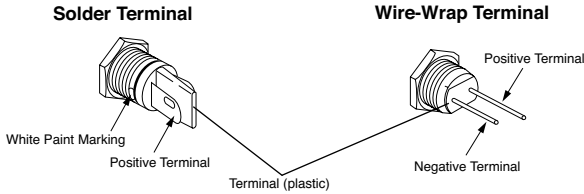

• Current Limiting Resistor

When using a UP series unit without a built-in current limiting resistor, connect an external current limiting resistor. Calculate the resistance using the following formula.

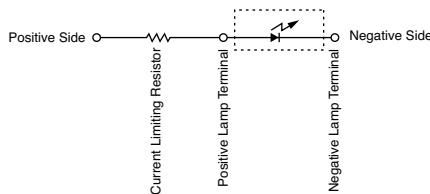

$$\text{Resistance (R)} = \frac{\text{Operating Voltage} - V_F}{I_F}$$

Reference Value of Current Limit Resistor

	Amber, Green, Red, Yellow	White
5V DC	300Ω (1/4W)	200Ω (1/4W)
6V DC	390Ω (1/4W)	270Ω (1/4W)
12V DC	1000Ω (1/4W)	680Ω (1/4W)
24V DC	2200Ω (1/2W)	1500Ω (1/2W)

• Waterproof Type

The degree of protection is distinguished by the color of the terminal.

Terminal (Plastic)	Degree of Protection
Black	IP40 (standard)
Blue	IP65 (waterproof)

Wiring

Solder the terminal at 350°C within 3 seconds using a 60W soldering iron. SnAgCu type lead-free solder is recommended. When soldering, do not touch the pilot light housing with the terminal. Do not bend the terminal or apply excessive force to the terminal.

Notes on Operating Voltage

The rated operating voltage represents a complete DC value. When using a pulsating voltage such as a full-wave rectification voltage, keep peak currents within the forward current I_f . Peak currents exceeding I_f may shorten the life of the LED lamp.

Panel Mounting

When mounting UP series units on to the panel, refer to the table below for the recommended tightening torque. Do not tighten with excessive force, otherwise the locking ring will be damaged.

Type	Recommended Tightening Torque
UP06	0.29 N·m
UP7	0.39 N·m
UP8	0.49 N·m
UP9	0.59 N·m
UP9P	0.29 N·m
UP1	0.59 N·m
UP1P	0.29 N·m

UP Series Miniature Pilot Lights (Single Board Mounting Type)

Single board mounting for miniature LEDs. Same length as H6, L6, and LW series control units

- Five illumination colors: amber, green, red, white, yellow

Specifications

Rated Current	10 mA (Amber, Green, Red, Yellow) 15 mA (White)
Forward Current	20 mA maximum at 25°C
Reverse Voltage	3V maximum at 25°C
Power Consumption	60 mW maximum at 25°C
Operating Temperature	-20 to +55°C (no freezing)
Storage Temperature	-25 to +80°C (no freezing)
Forward Voltage	Maximum value: 3V Standard value: 2V (forward current: 10 mA)
Dielectric Strength	Between live and dead parts: 500V AC, 1 minute
Weight (approx.)	6g (UP8-89V)



ø8 ø9 ø10 UP8 / UP9P / UP1P

Mounting Hole Size	Shape	Degree of Protection	Type No.	Ordering Type No.	Color Code	Package Quantity
ø8 UP8	Deep shroud	IP40	UP8-89V②	UP8-89V②PN10	A: amber G: green	10
ø9 UP9	Deep shroud	IP65 (waterproof)	UP9P-99V②	UP9P-99V②PN10	R: red W: white	10
ø10 UP1P	Deep shroud	IP65 (waterproof)	UP1P-19V②	UP1P-19V②PN10	Y: yellow	10

• Specify a color code in place of ② in the Type No.

Note: Connect an external current limiting resistor in series. Otherwise, the LED may be damaged.

Dimensions

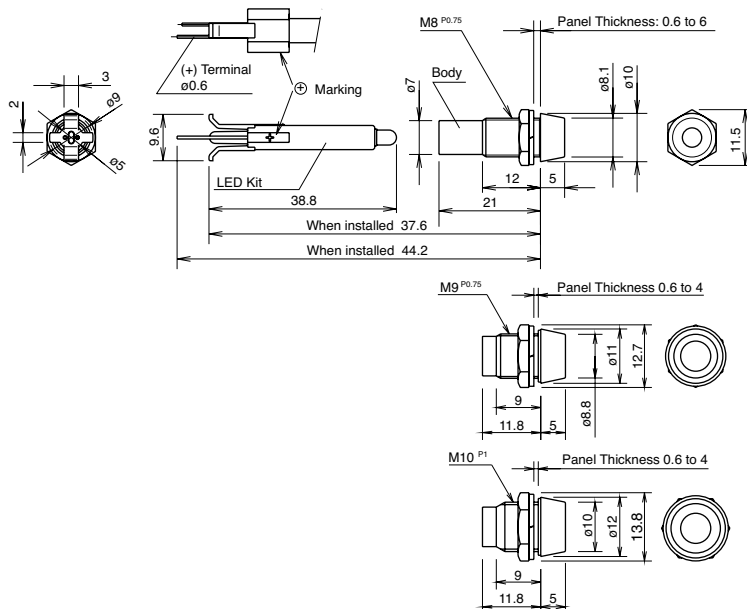

• UP8-89V

• UP9-99V

• UP1P-19V

All dimensions in mm.

• PC Board Mounting Hole

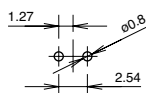

• Panel Cut-out

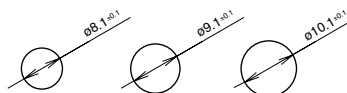

• Internal Circuit

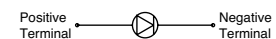

The longer pin is the positive terminal

ø6·7·8·9·10 UP Series Miniature Pilot Lights

Single Board Mounting

UP series miniature pilot light single board mounting types can be mounted with H6, L6, LW series control units on the same panel. Follow the instructions below on single board mounting.

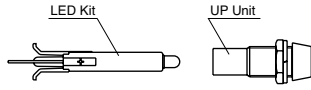

1. Mount the LED kit to the PC board.

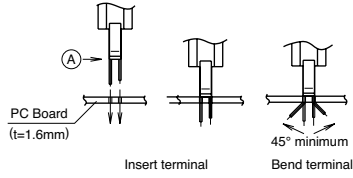

- Temporary mounting
- 1. Note the polarity of the terminals and insert the terminals to the PC board.
- 2. Make sure that part A of the LED kit is pressed tightly to the PC board. Bend the terminals sideways as shown on the left.

2. Mount the operator and the UP series pilot lights on to the control panel.

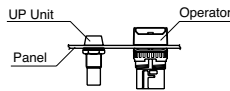

3. Mount the contact block to the operator of the miniature control unit and lock the unit by turning the locking lever.

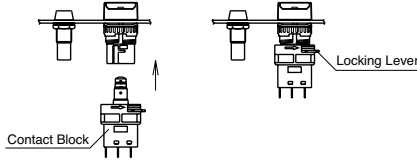

4. Install the PC board in 1. to the panel in 3.

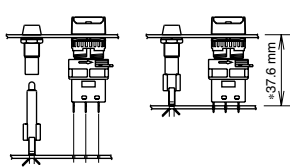

Note: Make sure that the LED kit is inserted into the UP series unit.

5. Solder the terminals.

Before soldering, make sure that each terminal of the contact block is securely inserted into the PC board holes.

- * When mounting H6, L6, LW, and UP series on a single board, make sure that the distance between the front of the panel and the mounting side of the PC board is 37.6 mm.

Safety Precautions

- Turn off power to the unit before installation, removal, wiring, maintenance, and inspection. Failure to turn off may cause electrical shocks or fire hazard.
- For wiring, use wires of a proper size to meet the voltage and current requirements. Improper soldering or failure to tighten the terminal screw may cause overheating and fire.

Instructions

• Polarity

Pay attention to the polarity of the power supply as UP series units do not contain a diode for protection against reverse polarity. The long terminal is positive and the short terminal is negative.

• Current Limiting Resistor

When using a UP series unit without a built-in current limiting resistor, connect an external current limiting resistor. Calculate the resistance using the following formula.

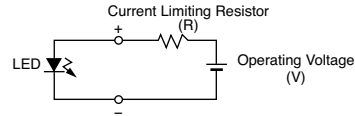

$$\text{Resistance (R)} = \frac{\text{Operating Voltage (V)} - 2}{\text{Rated Current (I)} *}$$

- * Rated Current (I) = 10 mA, except white color at 15 mA

Note: Use a resistor of higher resistance than the calculated value (R).

$$\text{Rated Wattage of Resistor (W)} = \text{Rated Current (I)} \times \text{Operating Voltage (V)} \times 2 \text{ to } 3 *$$

- * 2 to 3 is a safety factor

• Current Limiting Resistor Reference Value

Color	Amber, Green, Yellow, Amber	White
Operating Voltage		
5V DC	300Ω (1/4W)	200Ω (1/4W)
6V DC	390Ω (1/4W)	270Ω (1/4W)
12V DC	1000Ω (1/4W)	680Ω (1/4W)
24V DC	2200Ω (1/2W)	1500Ω (1/2W)

• Wiring

Solder the terminal at 350°C within 3 seconds using a 60W soldering iron. SnAgCu type lead-free solder is recommended. When soldering, do not touch the pilot light housing with the terminal. Do not bend the terminal or apply excessive force to the terminal.

• Notes on Panel Mounting

Use an optional locking ring wrench to mount the unit onto a panel. Tightening torque should not exceed 0.5 N·m. Do not use pliers. Do not tighten with excessive force, otherwise the locking ring will be damaged.

• PC Board and Circuit Design

Use glass epoxy copper clad laminate, double-sided through-hole PC boards with a thickness of 1.6 mm.

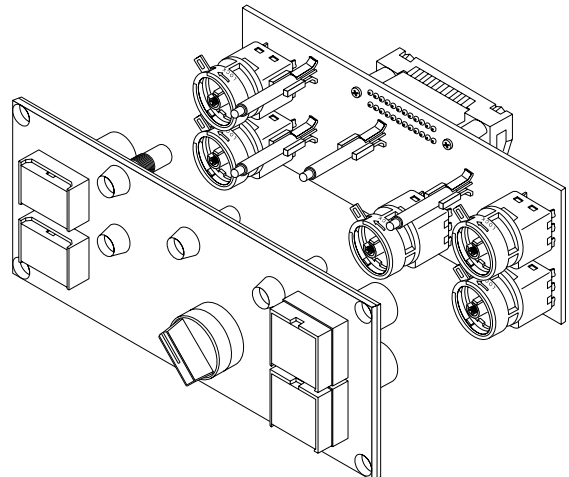

Example of single board mounting

UZ6 Series Miniature Buzzer ø16

Miniature Electronic Buzzer for mounting in ø16 mm Mounting Hole

- Same size and terminal alignment as AP6M series miniature pilot lights.
- Sounds can be adjusted from approximately 30 to 600 cycles per minute using the optional sound adapter.
- The sound adapter can be snapped on to the rear part of the buzzer unit.



Types





• Buzzer Unit (continuous sound)

Shape	Terminal Style	Operating Voltage	Type No. (Operating Type No.)	Package Quantity
	Solder	12V DC ±10%	UZ6-11	1
		24V DC ±10%	UZ6-12	1

• Cyclical Sound Adapter

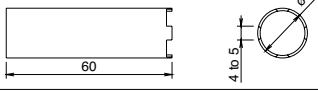
Shape	Terminal Style	Operating Voltage	Type No. (Operating Type No.)	Package Quantity
	Screw	12V/24V DC ±10%	UZ6-F10	1

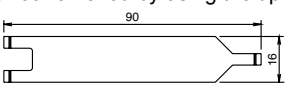
• Accessories

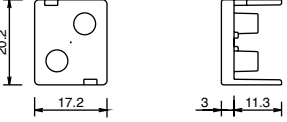
Shape	Specification	Type No. (Ordering Type No.)	Remarks
	Nickel-plated brass	MT-001	Used to tighten the locking ring when installing a UZ6 buzzer onto a panel. Tighten the locking ring to a torque of 0.88 N·m maximum. 
	Stainless steel	MT-100	Used to remove the cyclical sound adapter from the buzzer. The cyclical sound adapter can be removed by using the tip of the tool as shown in the left photo. 
	For cyclical sound adapter	AP-VL3	

Specifications

• Buzzer Unit

Insulation Voltage	60V DC
Operating Voltage	12V DC ±10%, 24V DC ±10%
Current Draw	24 mA
Sound Pressure (at 0.1m)	Steady sound: 75dB (at the rated voltage)
Sound Frequency	3.5 kHz ±800Hz
Operating Temperature	-20 to +50°C (no freezing)
Operating Humidity	45 to 85% RH (no condensation)
Insulation Resistance	100 MΩ minimum (500V DC megger)
Dielectric Strength	Between live and dead parts: 1,000V AC, 1 minute
Degree of Protection	IP40 (enclosed type)
Terminal Style	Solder terminal
Applicable Wire	ø1 or 0.75 mm ² max.
Cap Color	Blue
Weight (approx.)	6.5g

• Ratings / Cyclical Sound Adapter

Operating Voltage	12/24V DC ±10%
Current Draw	30 mA (when installed on the buzzer unit)
Cyclical Sound	30 to 600 cycles per minute (period: 2 to 0.1 sec) ON/OFF time ratio 1:1
Applicable Buzzer Unit	12V DC, 24V DC buzzers (UZ6-11, UZ6-12)
Terminal Screw	M3
Applicable Wire	1.25 mm ² max.
Weight (approx.)	13.5g

• LA3Z (ø16) buzzer units also available. See catalog for the L6 series Control Units.

Dimensions

• Buzzer Unit

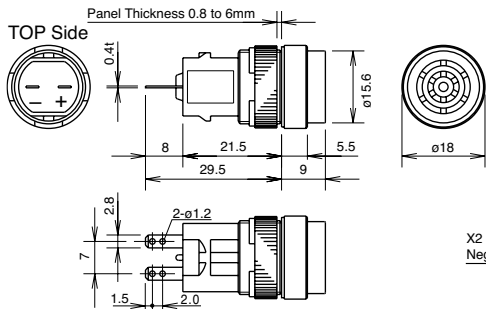

• Cyclical Sound Adapter

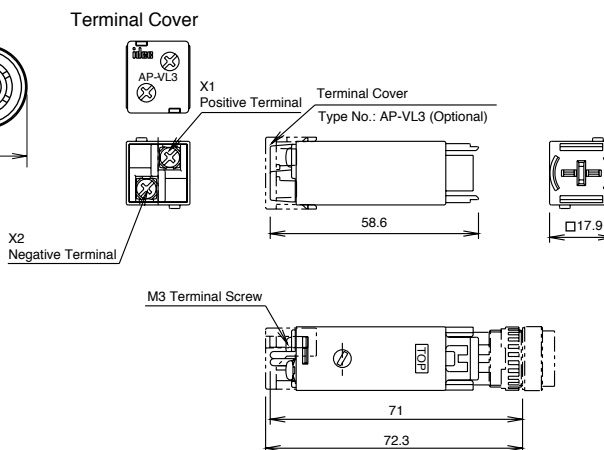

• Panel Cut-out

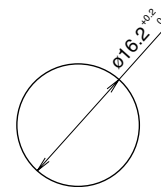

Instructions

• Notes on Panel Mounting

Use an optional locking ring wrench to mount the unit onto a panel. Tightening torque should not exceed 0.88 N·m. Do not use pliers. Do not tighten with excessive force, otherwise the locking ring will be damaged.

• Power Supply Noise

When the buzzer is used where power noise might occur, use a noise suppressor element to prevent noise interference.

• Cyclical Sound Adjustment

Pierce the round mark on the nameplate on top of the cyclical sound adapter with a flat screwdriver and adjust the variable resistor inside. Turn clockwise for longer cyclical sounds and counterclockwise for shorter cyclical sounds.

• Notes on Installing the Cyclical Sound Adapter

1. The cyclical sound adapter can be used on 12V and 24V DC buzzer units (UZ6-11, UZ6-12).
2. Mount the buzzer unit on the panel before installing the cyclical sound adapter on the panel. The buzzer unit cannot be mounted with the cyclical sound adapter installed.
3. When installing the cyclical sound adapter, make sure that the TOP marking on the cyclical sound adapter is on the same side as the TOP marking on the buzzer unit and press in.

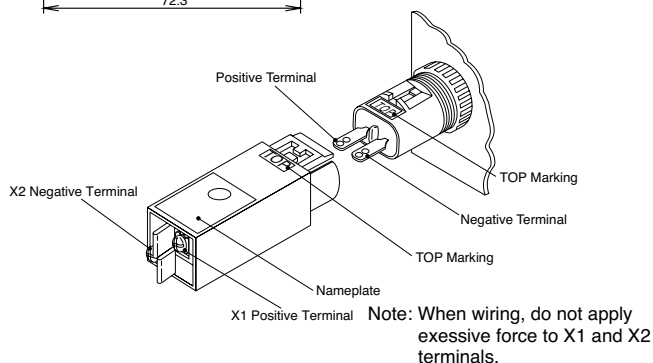

• Wiring

Solder the terminal at 350°C within 3 seconds using a 60W soldering iron. SnAgCu type lead-free solder is recommended. When soldering, do not touch the buzzer unit housing with the terminal. Do not bend the terminal or apply excessive force to the terminal.

Safety Precautions

- Turn off power to the buzzer before installation, removal, wiring, maintenance, and inspection. Failure to turn off may cause electrical shocks or fire hazard.
- For wiring, use wires of a proper size to meet the voltage and current requirements. Tighten the M3 screw terminal of the cyclical sound adapter to a torque of 0.6 to 1.0 N·m. Improper soldering or failure to tighten the terminal screw may cause overheating and fire.

Specifications and other descriptions in this catalog are subject to change without notice.



IDEC CORPORATION

7-31, Nishi-Miyahara 1-Chome, Yodogawa-ku, Osaka 532-8550, Japan
Tel: +81-6-6398-2571, Fax: +81-6-6392-9731
E-mail: products@idec.co.jp

IDEC CORPORATION (USA)
1175 Elko Drive, Sunnyvale, CA 94089-2209, USA
Tel: +1-408-747-0550 / (800) 262-IDEC (4332)
Fax: +1-408-744-9055 / (800) 635-6246
E-mail: opencontact@idec.com

IDEC CANADA LIMITED
Unit 22-151, Brunel Road, Mississauga, Ontario, L4Z 1X3, Canada
Tel: +1-905-890-8561, Toll Free: (888) 317-4332
Fax: +1-905-890-8562
E-mail: sales@ca.idec.com

IDEC AUSTRALIA PTY. LTD.
2/3 Macro Court, Rowville, Victoria 3178, Australia
Tel: +61-3-9763-3244, Toll Free: 1800-68-4332
Fax: +61-3-9763-3255
E-mail: sales@au.idec.com

IDEC ELECTRONICS LIMITED
Unit 2, Beechwood, Chineham Business Park, Basingstoke, Hampshire RG24 8WA, UK
Tel: +44-1256-321000, Fax: +44-1256-327755
E-mail: sales@uk.idec.com

IDEC ELEKTROTECHNIK GmbH
Wendenstrasse 331, 20537 Hamburg, Germany
Tel: +49-40-25 30 54 - 0, Fax: +49-40-25 30 54 - 24
E-mail: service@idec.de

IDEC (SHANGHAI) CORPORATION
Room 608-609, 6F, Gangtai Plaza, No. 700, Yan'an East Road, Shanghai 200001, PRC
Tel: +86-21-5353-1000, Fax: +86-21-5353-1263
E-mail: idec@cn.idec.com

IDEC (BEIJING) CORPORATION
Room 211B, Tower B, The Grand Pacific Building, 8A Guanghua Road, Chaoyang District, Beijing 100026, PRC
Tel: +86-10-6581-6131, Fax: +86-10-6581-5119

IDEC (SHENZHEN) CORPORATION
Unit AB-3B2, Tian Xiang Building, Tian'an Cyber Park, Fu Tian District, Shenzhen, Guang Dong 518040, PRC
Tel: +86-755-8356-2977, Fax: +86-755-8356-2944

IDEC IZUMI (H.K.) CO., LTD.
Unit 1505-07, DCH Commercial Centre No. 25, Westlands Road, Quarry Bay, Hong Kong
Tel: +852-2803-8989, Fax: +852-2565-0171
E-mail: info@hk.idec.com

IDEC TAIWAN CORPORATION
8F-1, No. 79, Hsin Tai Wu Road, Sec. 1, Hsi-Chih, Taipei County, Taiwan
Tel: +886-2-2698-3929, Fax: +886-2-2698-3931
E-mail: service@tw.idec.com

IDEC IZUMI ASIA PTE. LTD.
No. 31, Tannery Lane #05-01, Dragon Land Building, Singapore 347788
Tel: +65-6746-1155, Fax: +65-6844-5995
E-mail: info@sg.idec.com