

# FT2J 7" PLC+HMI

## The All-in-One Solution for Seamless Automation



### Product Description

A technologically advanced 7" vivid multi-touch display, with an integrated PLC controller and expandable I/O, makes the new FT2J Series a leading choice for many applications across a wide variety of industries. An exceptionally wide operating temperature range of -20°C to +55°C as well as IP66F, IP67F, Type 4X, 12, 13, and Class I Div 2 approval ratings, assures reliable operation in the toughest environments. These touchscreens are built for endurance and are backed by an industry-leading three-year warranty.

### Key Features

- 22 I/O (14 in/8 out) Points
- -20 to + 55°C Operating Temp.
- 800 x 400 pixels Display Resolution
- PCAP Glass Top HMI Design
- Embedded RJ45 Ethernet Port
- Built-in Analog Inputs and Outputs
- PID and PWM Controls
- Remote Access, FTP, Email, Mobile App and Custom Web Page



### FT2J

#### Part Numbers

Quantity: 1

Display screen	Operation style	Communication interface	Bezel color	Approvals	Input specifications		Output	Part No.
					Digital input	Analog input		
7-inch wide TFT color LCD	PCAP touchscreen (Projected capacitive)	Serial interface (RS232C, RS422/485), Ethernet, USB	Black	UL61010-1 UL61010-2-201 UL121201 CSA C22.2 No.61010-1 CSA C22.2 No.61010-2-201 CSA C22.2 No.213	14 points total (sink/source) (4 of them configurable as analog inputs)		8 point 2A relay output	FT2J-7U22RAF-B
							6 point transistor sink output 2 point analog output	FT2J-7U22KAF-B
							6 point transistor source output 2 point analog output	FT2J-7U22SAF-B

### Dimensions

All dimensions in mm.

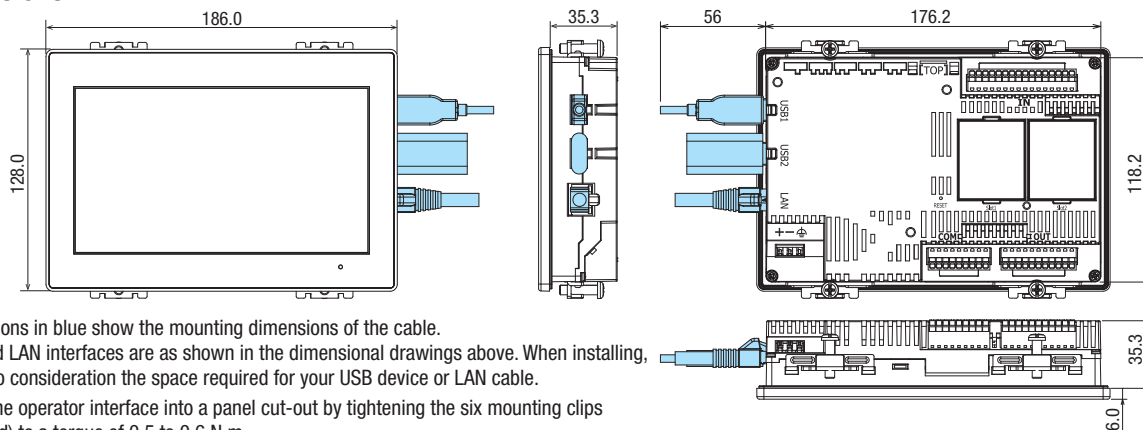

- Dimensions in blue show the mounting dimensions of the cable. USB and LAN interfaces are as shown in the dimensional drawings above. When installing, take into consideration the space required for your USB device or LAN cable.
- Install the operator interface into a panel cut-out by tightening the six mounting clips (supplied) to a torque of 0.5 to 0.6 N-m. Do not tighten with excessive force, otherwise the main unit may become distorted and waterproof characteristics may be lost.

### Mounting hole layout

All dimensions in mm.

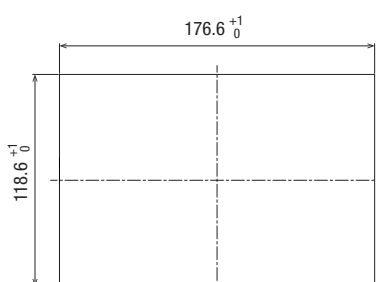

- Panel Thickness: 1.0 to 5.0 mm

### General Specifications

Electrical	Rated power voltage	24V DC	
	Power voltage range	20.4 to 28.8V DC	
	Power consumption	Backlight off 3W maximum when not using USB1, USB2, IN, OUT, Slot 1, Slot 2	
		5W when not using USB1, USB2, IN, OUT, Slot 1, Slot 2 17W maximum	
Allowable instantaneous blackout period	10ms maximum (power supply voltage: 24.0V to 28.8V DC) 5ms maximum (power supply voltage: 20.4V to 24.0V DC)		
Environmental	Inrush Current	40A maximum	
	Dielectric strength	500V AC, 5mA, 1 minute between power and FG terminals 500V AC, 5mA, 1 minute between input and FG terminals 2300V AC, 5mA, 1 minute between relay output and FG terminals 500V AC, 5mA, 1 minute between transistor output and FG terminals 500V AC, 5mA, 1 minute between power and input terminals 2300V AC, 5mA, 1 minute between power and relay output terminals 500V AC, 5mA, 1 minute between power and transistor output terminals 2300V AC, 5mA, 1 minute between input and relay output terminals	
		Operating temperature	-20 to +55°C (no freezing)
		Operating humidity	10 to 95%RH (no condensation)
Storage temperature		-20 to +70°C (no freezing)	
Mechanical	Storage humidity	10 to 95%RH (no condensation)	
	Pollution degree	2	
	Corrosion immunity	Free from corrosive gases	
	Vibration resistance	5 to 8.4Hz single amplitude 3.5mm, 8.4 to 150Hz acceleration 9.8m/s <sup>2</sup> (10 times each in 3 axes) (IEC61131-2)	
Shock resistance		147m/s <sup>2</sup> 11ms (3 times in each in 3 axes) (IEC61131-2)	
Noise	First transient/burst	±2kV (power supply terminal) ±1kV (communication line)	
	Electrostatic discharge	±6kV (contact discharge) ±8kV (air discharge)	
Structure	Mounting	Panel mount (panel thickness: 1.0 to 5.0mm)	
	Degree of Protection	When panel thickness is between 1mm and 1.6mm: IP65F (IEC 60529) When panel thickness is between 1.6mm and 5mm: IP66F, IP67F (IEC 60529), TYPE 4X (indoor use only), TYPE 13	
	Dimensions	186 (W) x 128 (H) x 41.3 (D) mm	
	Weight (approx.)	600g	

### Display Specifications

Display	TFT color LCD	
Color / Shade	65,536 colors (16-bit color)	
Effective display area	154.08 (W) x 85.92 (H) mm	
Display resolution	800 (W) x 480 (H) dot	
Dot pitch	0.1926 (W) x 0.179 (H) mm	
View angle	Left/right/top: 80°, bottom 60°	
Backlight	White LED	
Backlight life	50,000 hours standard	
Brightness	500 cd/m <sup>2</sup> (Typ.)	
Brightness adjustment	48 levels	
Character code	Shift_JIS (Japanese)	ANSI 1250 (Central European)
	ISO8859-1 (European)	ANSI 1257 (Baltic)
	GB2312 (Simplified Chinese)	ANSI 1251 (Cyrillic)
	BIG5 (Traditional Chinese)	ASCII (7 seg)
	KSC5601 (Hangul)	
Character size	8 to 512	
Character attribute	Bold, shadowed, blink (1 or 0.5 sec period)	
Graphics	Straight line, continuous line, rectangle, circle, arc, fan, ellipse, equilateral polygon (3, 4, 5, 6, 8), bitmap shape	
Window display	3 popup screens + 1 system screen	

### Operation Specifications

Switching element	PCAP touchscreen (projected capacitive)
Multiple press	Up to 2 points
Acknowledgment sound	Electronic buzzer

### Function Specifications

Screen types	Base screen, popup screen, system screen
Number of screens	Base screen: 3,000 maximum Popup screen: 3,015 maximum
User memory	HMI function :24MB approx. Control function : 96KB (equivalent to 12,000 steps)
Parts	Bit Button, Word Button, Goto Screen, Print Button, Key Button, Multi Button, Keypad, Numerical Input, Character Input, Pilot Lamp, Multi-State Lamp, Picture Display, Message Display, Message Switching Display, Alarm List Display, Alarm Log Display, Data Log Display, Numerical Display, Bar Graph, Trend Chart, Pie Chart, Meter, Calendar, Bit Write Command, Word Write Command, Goto Screen Command, Print Command, Timer, Screen Script Command, Multi Command
Backup data (Stored in nonvolatile memory)	HMI function: HMI keep relay, HMI keep register, log data Control function: Internal relay, shift register, counter, data register, special data register, special internal relay
Calendar (Stored in a large capacity capacitor)	Year, Month, Day, Hour, Min., Sec., Day of Week ±60 sec per month (at 25°C)
Clock backup time	20 days (at operating temperature of 25°C) (*1)

\*1) If the power is cut off for a certain amount of time, the clock data will be initialized to "00:00:00 January 1, 2000" at the next start up. Log data, HMI keep relay, HMI keep register is stored in a volatile memory so there is no backup time limit.

### Interface Specifications

Serial interface (COM) (*2)	RS232C	Electrical characteristics	EIA RS232C compliant
		Transmission speed	1200/2400/4800/9600/ 19,200/38,400/57,600/ 115,200/187,500 bps (*3)
		Synchronization	Asynchronous
		Communication method	Half or full duplex
		Control system	Hardware control or none
		RS422 / 485	Electrical characteristics
	Transmission speed		1200/2400/4800/9600/ 19,200/38,400/57,600/ 115,200/187,500 bps (*3)
	Synchronization		Asynchronous
	Communication method		Half or full duplex
	Control system		None
	Connector		Detachable 9-pin terminal block
	Ethernet interface (LAN)	Interface specifications	IEEE802.3u (10BASE-T/100BASE-TX) compliant
Connector		Modular jack (RJ-45)	
USB interface (USB1) (*4)	Interface specifications	USB2.0 High speed (480Mbps)	
	Connector	USB Type A connector	
USB interface (USB2) (*4)	Interface specifications	USB2.0 High speed (480Mbps)	
	Connector	USB Type A connector	

\*2) RS232C and RS 422/485 can be used simultaneously

\*3) 187,500 bps is available only with SIEMENS SIMATIC S7-300/400 series (MPI port direct connection).

\*4) USB output current varies depending on the mounting direction and ambient temperature.

### Serial Interface Connector Terminal Arrangement

Name	I/O	Function	Communication
SD	OUT	Sent data	RS232C
RD.	IN	Receive data	
RS	OUT	Request to send	
CS	IN	Clear to send	
SG	-	Signal ground	RS232C, RS422/485
SDA	OUT	Send data "+"	RS422/485
SDB	OUT	Send data "-"	
RDA	IN	Receive data "+"	
RDB	IN	Receive data "-"	

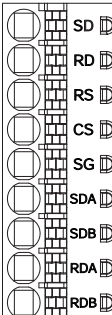

### Performance Specifications

Part No.		FT2J-7U22RAF-B	FT2J-7U22KAF-B	FT2J-7U22SAF-B	
Instruction words (control function)	Basic instructions	42			
	Advanced instructions	109			
Number of user program downloads		1000 times			
Processing time (control function)	Basic instructions	100µs/1000 steps			
	END processing	2ms			
Built-in I/O points	Input	Digital	10 (sink/source common)		
		Analog/Digital common	4 (0 to 10VDC/4 to 20mA, 12-bit resolution) / (sink/source)		
	Output	Relay	8 (2A)	-	-
		Transistor sink	-	6	-
		Transistor source	-	-	6
		Analog	-	2 (0-10V DC/4-20mA, 12-bit resolution)	
Cartridge	Number of slots	2			
	Connectable cartridge types	7 (Digital I/O cartridges: 3 analog I/O cartridges: 4)			
	Expandable I/O points	Digital I/O: 8 maximum Analog I/O: 4 maximum			
High-speed counter	Single/two-phase common	1 (2 times: 10kHz, 4 times: 5kHz)			
	Single phase only	4 (20kHz)			
Pulse output	Number of points	-	4		
	Maximum response frequency	-	20KHz		
	Function	-	PULS and PWM instructions		
Number of devices (control function)	Internal relay	6400			
	Special internal relay	144			
	Shift register	128			
	Data register	4000			
	Special data register	200			
	Additional/reversible counters	200			
	Timer (1ms, 10ms, 100ms, 1s)	200			

### Input Specifications

Digital Input	Input points	10		
	Input type	Sink/source		
	Input voltage range	0 to 28.8V DC		
	Rated input current	I0 to I5: 4mA / 1 point I6, I7, I10, I11: 5mA / 1 point		
	Input impedance	I0 to I5: 5.6kΩ I6, I7, I10, I11: 4.3kΩ		
	Input delay time	OFF → ON	I0 to I5: 25µs + soft filter setting I6, I7, I10, I11: 100µs + soft filter setting	
		ON → OFF	I0 to I5: 25µs + soft filter setting I6, I7, I10, I11: 100µs + soft filter setting	
	Isolation	Between input terminals	Not isolated	
		Internal circuit	Photocoupler-isolated	
	Input type	Type1 (IEC 61131)		
External load for I/O interconnection	Not needed			
Operating level	OFF voltage	5V DC maximum		
	ON voltage	15V DC minimum		
	OFF current	I0 to I5: 0.5mA maximum I6, I7, I10, I11: 0.9mA maximum		
	ON current	I0 to I5: 2.2mA minimum I6, I7, I10, I11: 3.2mA minimum		
Number of inputs	4			
Input style	Voltage/current input (selectable)			
Input range	0 to 10V DC / 4 to 20mA			
Sampling duration time	5ms maximum			
Total input delay time	6ms + 1 scan time			
Analog resolution	4096 (12 bit)			
Input error	25°C	±3% of full scale		
	Total	±5% of full scale		
Isolation	Between input terminals	Not isolated		
	Internal circuit	Not isolated		
When used as digital input	Digital input type	Type 1 (not conforming to IEC 61131-2)		
	Operating Level	OFF voltage	5V DC maximum	
		ON voltage	15V DC minimum	
		OFF current	0.06mA maximum	
		ON current	0.20mA minimum	

### Output Specifications

Transistor output	Output type / points	Transistor sink	6	
		Transistor source	6	
	Rated load voltage	24V DC		
	Input voltage range	20.4 to 28.8V DC		
	Maximum load current	1 point	0.5A maximum	
		1 common	3A maximum	
	Voltage drop (ON voltage)	1V maximum (voltage between COM and output terminals when on)		
	Maximum inrush current	1A		
	Leakage current	0.1mA maximum		
	Inductive load	L/R = 10ms (28.8V DC, 1Hz)		
External current draw	100mA maximum 24V DC			
Isolation	Photocoupler-isolated			
Output delay time	OFF → ON	Q0 to Q3: 25µs maximum Q4 to Q5: 300µs maximum		
	ON → OFF	Q0 to Q3: 25µs maximum Q4 to Q5: 300µs maximum		
Output points	8			
Rated load current	240V AC 2A 30V DC 2A			
Minimum switching load	1mA/5V DC (reference value)			
Initial contact resistance	30mΩ maximum			
Electrical life	100,000 times min. (resistance load: 1800 operations/hour)			
Mechanical Life	20 million times min. (no load: 18000 operations/hour)			
Output points	2 points			
Output type	Voltage/current output (selectable)			
Output range	0 to 10V DC / 4 to 20mA			
Output load impedance	2kΩ minimum (voltage) 500Ω maximum (current)			
Output load type	Resistive load			
Maximum error at 25°C	±0.3% of full scale			
Temperature coefficient	±0.02% of full scale/°C			
Reproducibility after stability time	±0.4% of full scale			
Non-linearity	±0.01% of full scale			
Output ripple	30mV maximum			
Overshoot	0% (*1)			
Overall accuracy	±1.0% of full scale			
Effects of improper output connection	None			
Digital resolution	4096 (12 bit)			
Monotonicity	Yes			
Open current loop	Cannot be detected			

\*1) Overshoot may occur under light load conditions. Overshoot can be suppressed by inserting a damping resistor. Damping resistor value: approx. 150Ω including the input impedance.

**Cartridge**

**Digital I/O Cartridge Specifications**

**Input Cartridge**

Part No.		FC6A-PN4
Input points		4 points (4/1 common)
Rated input voltage		12/24V DC sink/source common
Operating input voltage range		0 to 28.8V DC
Rated input current		2.5mA / 1 point (12V DC) 5mA / 1 point (24V DC)
Input impedance		4.4kΩ
Operating level	OFF voltage	Less than 5V
	ON voltage	8.5V minimum
	OFF current	Less than 0.9mA
	ON current	1.7mA minimum (at applied voltage of 8.5V)
Input delay time (24V DC)	OFF → ON	0.5ms
	ON → OFF	0.5ms
Isolation		Between channels: Not isolated Internal circuit: Photocoupler-isolated
I/O connection		No external load required for I/O interconnection
Signal determination method		Static
Effect of improper input connection		Both sink and source can be connected. However, if voltage exceeding the rated value is applied, permanent damage may be caused.
Cartridge internal current draw	All ON	35mA (3.3V DC) 0mA (5V DC)
	All OFF	30mA (3.3V DC) 0mA (5V DC)
Cartridge internal power consumption (at 24V DC while all inputs are ON)		0.10W
Cable length		3m in compliance with electromagnetic immunity
Applicable rod terminal		For 1-wire: AI 0.5-8 WH (Phoenix Contact)
Weight (approx.)		15g

**Output Cartridge**

Part No.		FC6A-PTK4	FC6A-PTS4
Output points		4 points sink output (4/1 common)	4 points source output (4/1 common)
Rated load voltage		12/24V DC	
Input voltage range		10.2 to 28.8V DC	
Load current	1 point	0.1A maximum	
	1 common	0.4A maximum	
Output delay time	ON → OFF	450us maximum	
	OFF → ON	450us maximum	
Isolation		Between input terminals: Non-isolated Internal circuit: Photocoupler-isolated	
Voltage drop (ON voltage)		1V maximum (voltage between COM and output when on.)	
Allowable inrush current		1A maximum	
Leakage current		Less than 0.1mA	
Clamping voltage		Approx. 50V	
Lamp load		2.4W maximum	
Inductive load		L / R=10ms (28.8V DC, 1Hz)	
External current draw		100mA maximum 24V DC (+V terminal supply power)	100mA maximum 24V DC (-V terminal supply power)
Overcurrent protection		No	
Cartridge internal current draw	All outputs ON	35mA (3.3V DC) 0mA (5V DC)	
	All outputs OFF	30mA (3.3V DC) 0mA (5V DC)	
Cartridge internal power consumption: (at 24V DC while all outputs ON)		0.10W	
Applicable rod terminal		For 1-wire: AI 0,5-6 (manufactured by Phoenix Contact)	
Weight (approx.)		15g	

Cartridge

Analog Cartridge

Performance Specifications

Part No.	FC6A-PJ2A		FC6A-PJ2CP		FC6A-PK2AV		FC6A-PK2AW	
Type	Voltage / current input		Temperature input		Voltage output		Current output	
I/O points	2		2		2		2	
Rated voltage	5.0V, 3.3V (supplied from main unit)							
Current draw	5.0V: - 3.3V: 30mA				5.0V: 70mA 3.3V: 30mA		5.0V: 185mA 3.3V: 30mA	
Weight	15g							

Input Specifications

Part No.	FC6A-PJ2A		FC6A-PJ2CP	
Type	Voltage input	Current input	Resistance thermometer	Thermocouple
Input range	0 to 10V DC	4 to 20mA DC 0 to 20mA DC	Pt100 : -200 to +850°C Pt1000: -200 to +600°C Ni100 : -60 to +180°C Ni1000 : -60 to +180°C 3-wire RTD	K: -200 to 1300°C J: -200 to 1000°C R: 0 to 1760°C S: 0 to 1760°C B: 0 to 1820°C E: -200 to 800°C T: -200 to 400°C N: -200 to 1300°C C: 0 to 2315°C
Input impedance	1MΩ minimum	250Ω maximum	1MΩ minimum	
Allowable conductor resistance	-		10Ω maximum	-
Input detection current	-		Typ: 0.2mA, 1.0mA maximum	
AD Conversion	Sampling duration time	10ms	250ms	
	Sampling interval	20ms	500ms	
	Total input delay time	20ms + scan time		500ms + scan time
	Type of input	Single-ended input		
	Operation mode	Self-scan		
Conversion method	SAR			
Input error	Maximum error at 25°C	±0.1% of full scale	±0.1% of full scale	0.1% of full scale Cold junction compensation accuracy ±4.0°C max. [Exceptions] R, S Thermocouple error: ±6.0°C (0 to 200°C range only) B Thermocouple error: not guaranteed (0 to 300°C range only) K, J, E, T, N Thermocouple error: ±0.4% of full scale (0°C or lower range only)
	Temperature coefficient	±0.02%/°C of full scale		
	Reproducibility after stabilization time	±0.5% of full scale		
	Non-linearity	±0.01% of full scale		
	Total error	±1.0% of full scale		
	Digital resolution	4096 (12 bits)		Pt100 : 10500 (14 bits) Pt1000 : 8000 (13 bits) Ni100 : 2400 (12 bits) Ni1000 : 2400 (12 bits)
LSB input value	2.44mV (0 to 10V DC)	4.88μA (0 to 20mA DC) 3.91μA (4 to 20mA DC)	0.1°C 0.18°F	
Data format in application	Can be arbitrarily set for each channel in the range of -32,768 to 32,773			
Monotonicity	Yes			
Noise resistance	Maximum temporary Deviation during electrical noise tests	±4.0% of full scale maximum		
	Recommended cable	Shielded twisted pair	Twisted pair	
	Crosstalk	1 LSB maximum		
Insulation	None			
Effect when input is incorrectly wired	No damage			
Maximum allowable constant load (non-destructive)	13V DC	40mA	13V DC	
Input type modification	Soft programming			
Calibration to maintain rated accuracy	Impossible			







Output Specifications

Part No.	FC6A-PK2AV		FC6A-PK2AW	
Type	Voltage output		Current output	
Output type	Voltage output	0 to 10V DC		-
	Current output	-	4 to 20mA DC	
Load	Impedance	2kΩ minimum		500Ω maximum
	Load type	Resistive load		
D/A conversion	Scan time	20ms		
	Settling time	40ms maximum	20ms maximum	
	Total output delay time	60ms + Scan time	40ms + Scan time	
Output error	Maximum error at 25°C	±0.3% of full scale		
	Temperature coefficient	±0.02% / °C of full scale		
	Reproducibility after stability time	±0.4% of full scale		
	Non-linearity	±0.01% of full scale		
	Output ripple	30mV maximum		
	Overshoot	0%		
	Overall accuracy	±1.0% of full scale		
Data	Effect of improper output terminal connection	No damage		
	Digital resolution	4096 (12 bits)		
	LSB output value	2.44mV (0 to 10V)	3.91μA (4 to 20mA)	
	Data format in application	0 to 4095 (0 to 10V)	0 to 4095 (4 to 20mA)	
	Monotonicity	Yes		
Noise Resistance	Open current loop	-	Not detectable	
	Maximum temporary deviation during electrical noise tests	±4.0% of full scale maximum		
	Recommended cables	Shielded twisted pair		
Crosstalk	1 LSB maximum			
Isolation	None			
Calibration to maintain rated accuracy	Impossible			
Selection of output signal type	Voltage output only		Current output only	





Applicable wire

Part No.	FC6A-PJ2A	FC6A-PJ2CP	FC6A-PK2AV	FC6A-PK2AW
Applicable wires and specifications	0.3mm <sup>2</sup> (AWG22) Shielded twisted pair	0.3mm <sup>2</sup> (AWG22) Shielded twisted pair	0.3mm <sup>2</sup> (AWG22) Shielded twisted pair	

### Accessories

Name / Shape		Part No. (Ordering No.)	Quantity	Specification	
System integration software		SW1A-W1C	1	Automation Organizer (Includes WindO/I-NV4)	
Protective sheet		HG9Z-2D7PN05	5	For 7.0 inch screen. Used to protect the LCD from UV light. Includes 5 pcs. Dimensions: 182.4 x 124.4 mm, sheet thickness: 0.153 mm	
UV protective sheet		FT9Z-2D7PN05		For 7.0 inch screen, used to protect the LCD from UV light. Water adhesive. Includes 5 pcs. Dimensions: 182.4 x 124.4 mm, sheet thickness: 0.153 mm	
USB relay port		CW1X-USB20-1M	1	Bezel color: black	Cable length: 1m USB2.0 TypeA
		CW4X-USB20-1M		Bezel color: metallic	
RJ45 relay port		CW1X-RJ45	1	Bezel color: black	Number of contacts: 8-pin
		CW4X-RJ45		Bezel color: metallic	
Rubber cap (*1)		CW9Z-D1X1	1	Material: TPE Color: black Protection: IP65/67	
Plastic cover (*1)		CW9Z-D1X2	1	Material <Lens> Polycarbonate resin <Body> Polyamide resin <Packing>NBR Color : Translucent Protection: IP65/67	
Digital I/O cartridge	Digital input	FC6A-PN4	1	Digital input (4 points)	
	Digital output	FC6A-PTK4	1	Transistor sink output (4 points)	
		FC6A-PTS4	1	Transistor source output (4 points)	
Analog cartridge		FC6A-PJ2A	1	Voltage current input (2 points)	
		FC6A-PK2AV	1	Voltage output (2 points)	
		FC6A-PK2AW	1	Current output (2 points)	
		FC6A-PJ2CP	1	Temperature input (2 points)	

### Maintenance Parts

Name	Shape	Part No. (Ordering No.)	Quantity	Specification
Mounting clip		HG9Z-4K2PN04	4	Four clips are supplied with the main unit.
Serial interface connector		HG9Z-XT09P	1	Removable terminal block 9-pin, push-in type One plug is supplied with the main unit..
Input terminal connector		FT9Z-XT16P	1	Detachable terminal block 16-pin, push-in type One plug is supplied with the main unit.
Output terminal connector		FT9Z-XT11P	1	Detachable terminal block 11-pin, push-in type One plug is supplied with the main unit.

\*1) Exclusive for CW series relay ports (CW1X /CW4X) and cannot be used for other models.

Refer to the instruction manual from the QR code on the right for details on how to use the product.





Terminal Layout and Wiring Example (For details, see the instruction manual.)

Fuse Load

FT2J-7U22RAF-B

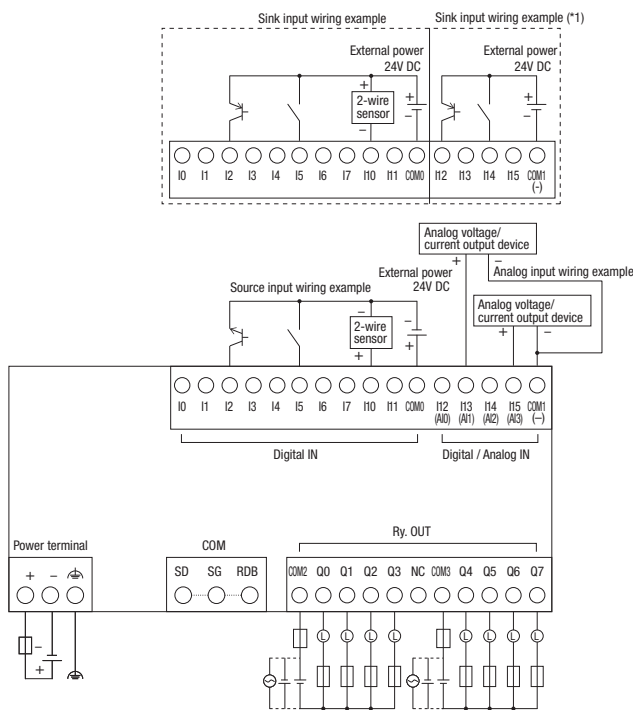

FT2J-7U22KAF-B

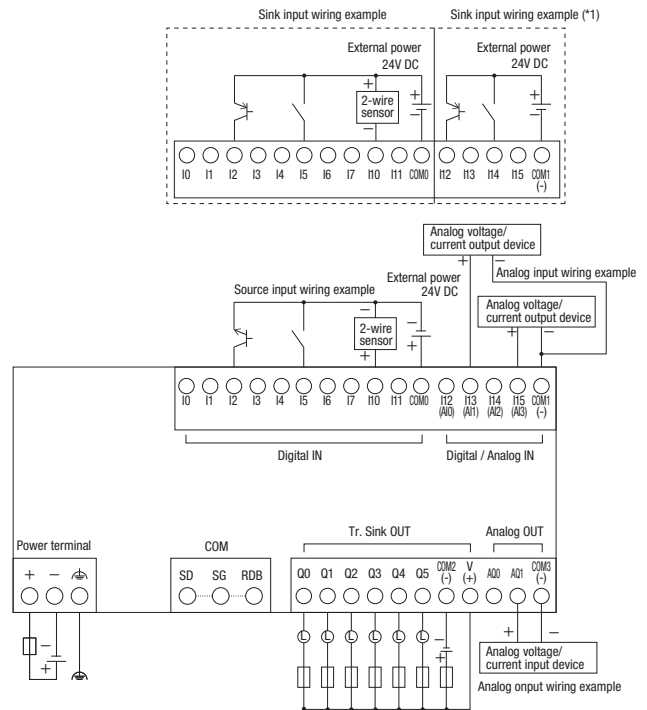

FT2J-7U22SAF-B

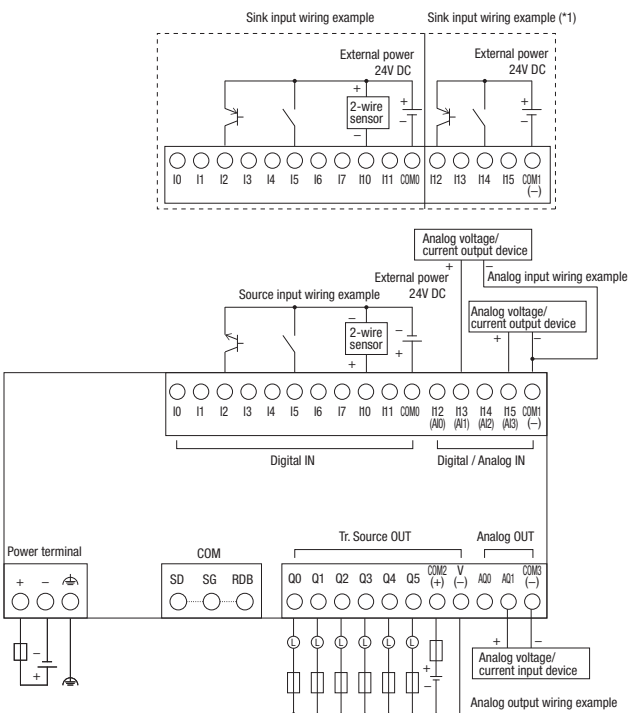

• I12 to I15 cannot be used as source inputs.

Recommended Rod Terminals and Crimping Tools

Applicable wire / Recommended ferrule

When wiring, use the applicable wires shown below. In addition, use the following applicable rod terminals for wiring to each terminal.

Applicable wire (*1)	Power supply unit : AWG14 to 28 Input terminal, output terminal, serial interface: AWG16 to 24		
Wire strip length (*1)	Power supply unit: 7 to 9mm Input terminal, output terminal, serial interface: 8 to 9 mm		
Recommended ferrule	IDEC	Weidmüller	Phoenix Contact
	Part No.	Part No.	Part No.
	S3TL-H025-12WJ	H0.25/12 HBL	AI 0,25-8YE
	S3TL-H034-12WT	H0.34/12 TK	AI 0,34-8TQ
	S3TL-H05-14WA	H0.5/14 OR	AI 0,5-8WH
	S3TL-H075-14WW	H0.75/14 W	AI 0,75-8GY

\*1) When single or stranded wires are used.

Recommended tools (sold separately)

	Name	Part No.	Ordering No.	Manufacturer
Flat screwdriver	Standard model	SDS 0.4 x 2.5 x 75	2749320000	Weidmüller
	With insulation cover	S3TL-D04-25-75 SDIS 0.4x2.5x75	S3TL-D04-25-75 2749790000	IDEC Weidmüller
Crimping tool		S3TL-CR06D	S3TL-CR06D	IDEC
Stripping tool		STRIPAX	S3TL-ST16	IDEC

## Ordering Terms and Conditions

Thank you for using IDEC Products.

By purchasing products listed in our catalogs, datasheets, and the like (hereinafter referred to as "Catalogs") you agree to be bound by these terms and conditions. Please read and agree to the terms and conditions before placing your order.

### 1. Notes on contents of Catalogs

- (1) Rated values, performance values, and specification values of IDEC products listed in this Catalog are values acquired under respective conditions in independent testing, and do not guarantee values gained in combined conditions.  
Also, durability varies depending on the usage environment and usage conditions.
- (2) Reference data and reference values listed in Catalogs are for reference purposes only, and do not guarantee that the product will always operate appropriately in that range.
- (3) The specifications / appearance and accessories of IDEC products listed in Catalogs are subject to change or termination of sales without notice, for improvement or other reasons.
- (4) The content of Catalogs is subject to change without notice.

### 2. Note on applications

- (1) If using IDEC products in combination with other products, confirm the applicable laws / regulations and standards.  
Also, confirm that IDEC products are compatible with your systems, machines, devices, and the like by using under the actual conditions. IDEC shall bear no liability whatsoever regarding the compatibility with IDEC products.
- (2) The usage examples and application examples listed in Catalogs are for reference purposes only. Therefore, when introducing a product, confirm the performance and safety of the instruments, devices, and the like before use. Furthermore, regarding these examples, IDEC does not grant license to use IDEC products to you, and IDEC offers no warranties regarding the ownership of intellectual property rights or non-infringement upon the intellectual property rights of third parties.
- (3) When using IDEC products, be cautious when implementing the following.
  - i. Use of IDEC products with sufficient allowance for rating and performance
  - ii. Safety design, including redundant design and malfunction prevention design that prevents other danger and damage even in the event that an IDEC product fails
  - iii. Wiring and installation that ensures the IDEC product used in your system, machine, device, or the like can perform and function according to its specifications
- (4) Continuing to use an IDEC product even after the performance has deteriorated can result in abnormal heat, smoke, fires, and the like due to insulation deterioration or the like. Perform periodic maintenance for IDEC products and the systems, machines, devices, and the like in which they are used.
- (5) IDEC products are developed and manufactured as general-purpose products for general industrial products. They are not intended for use in the following applications, and in the event that you use an IDEC product for these applications, unless otherwise agreed upon between you and IDEC, IDEC shall provide no guarantees whatsoever regarding IDEC products.
  - i. Use in applications that require a high degree of safety, including nuclear power control equipment, transportation equipment (railroads / airplanes / ships / vehicles / vehicle instruments, etc.), equipment for use in outer space, elevating equipment, medical instruments, safety devices, or any other equipment, instruments, or the like that could endanger life or human health
  - ii. Use in applications that require a high degree of reliability, such as provision systems for gas / waterworks / electricity, etc., systems that operate continuously for 24 hours, and settlement systems
  - iii. Use in applications where the product may be handled or used deviating from the specifications or conditions / environment listed in the Catalogs, such as equipment used outdoors or applications in environments subject to chemical pollution or electromagnetic interference  
If you would like to use IDEC products in the above applications, be sure to consult with an IDEC sales representative.

### 3. Inspections

We ask that you implement inspections for IDEC products you purchase without delay, as well as thoroughly keep in mind management/maintenance regarding handling of the product before and during the inspection.

### 4. Warranty

- (1) Warranty period  
The warranty period for IDEC products shall be three (3) years after purchase or delivery to the specified location. However, this shall not apply in cases where there is a different specification in the Catalogs or there is another agreement in place between you and IDEC.
- (2) Warranty scope  
Should a failure occur in an IDEC product during the above warranty period for reasons attributable to IDEC, then IDEC shall replace or repair that product, free of charge, at the purchase location / delivery location of the product, or an IDEC service base. However, failures caused by the following reasons shall be deemed outside the scope of this warranty.
  - i. The product was handled or used deviating from the conditions / environment listed in the Catalogs
  - ii. The failure was caused by reasons other than an IDEC product
  - iii. Modification or repair was performed by a party other than IDEC
  - iv. The failure was caused by a software program of a party other than IDEC
  - v. The product was used outside of its original purpose
  - vi. Replacement of maintenance parts, installation of accessories, or the like was not performed properly in accordance with the user's manual and Catalogs
  - vii. The failure could not have been predicted with the scientific and technical standards at the time when the product was shipped from IDEC
  - viii. The failure was due to other causes not attributable to IDEC (including cases of force majeure such as natural disasters and other disasters)
 Furthermore, the warranty described here refers to a warranty on the IDEC product as a unit, and damages induced by the failure of an IDEC product are excluded from this warranty.

### 5. Limitation of liability

The warranty listed in this Agreement is the full and complete warranty for IDEC products, and IDEC shall bear no liability whatsoever regarding special damages, indirect damages, incidental damages, or passive damages that occurred due to an IDEC product.

### 6. Service scope

The prices of IDEC products do not include the cost of services, such as dispatching technicians. Therefore, separate fees are required in the following cases.

- (1) Instructions for installation / adjustment and accompaniment at test operation (including creating application software and testing operation, etc.)
- (2) Maintenance inspections, adjustments, and repairs
- (3) Technical instructions and technical training
- (4) Product tests or inspections specified by you

The above content assumes transactions and usage within your region. Please consult with an IDEC sales representative regarding transactions and usage outside of your region. Also, IDEC provides no guarantees whatsoever regarding IDEC products sold outside your region.

## IDEC CORPORATION

USA Office 1175 Elko Drive Sunnyvale, CA 94089

Japan Head Office  
EMEA APEM SAS

Singapore IDEC Izumi Asia Pte. Ltd.  
Thailand IDEC Asia (Thailand) Co., Ltd.  
India IDEC Controls India Private Ltd.

China IDEC (Shanghai) Corporation  
IDEC Izumi (H.K.) Co., Ltd.  
Taiwan IDEC Taiwan Corporation

Japan IDEC Corporation

 <https://us.idec.com>