

INTRODUCTION

Thank you for choosing an HK Instruments DPT-Priima differential pressure transmitter. DPT-Priima is a high-precision differential pressure transmitter engineered especially for cleanrooms and other high accuracy applications. DPT-Priima has an automatic zero point calibration and is optionally available with span point calibration, local display and calibration certificate. The versatility of the device is enhanced by eight selectable measuring ranges and by outputs with a voltage or current signal.

APPLICATIONS

DPT-Priima is commonly used in applications requiring high measurement accuracy:

- monitoring pressure in cleanrooms
- monitoring pressure difference across the building envelope
- monitoring pressure and flow

SPECIFICATIONS

Performance

Measurement accuracy* (from applied pressure):

0.4 % \pm 0.4 Pa

(including: general accuracy, linearity, hysteresis, long term stability, and repetition error)

Output accuracy*:

Voltage: \pm 0.025 V at 25 °C

Current: \pm 0.04 mA typical, at 25 °C, load 100 Ω
 \pm 0.1 mA max, at 25 °C, load 20–500 Ω

*after an half-hour warm-up time

Overpressure:

Proof pressure: 10 kPa

Burst pressure: 30 kPa

Zero point calibration:

Automatic autozero and manual pushbutton

Response time:

0.4 s or 8.0 s, selectable via jumper
(63 % of the change)

Technical Specifications

Media compatibility:

Dry air or non-aggressive gases

Measuring units:

Pa, kPa, mbar, inchWC, mmWC, psi, selectable via jumper

Measuring element:

MEMS, no flow-through

Environment:

Operating temperature: -5...50 °C,

Temperature compensated range 0...50 °C

Storage temperature: -40...70 °C,

Humidity: 0 to 95 % rH, non-condensing

Physical

Dimensions:

Case: 90.0 x 95.0 x 36.0 mm

Weight:

140g

Mounting:

2 each 4.3 mm screw holes, one slotted

Materials:

Case: ABS

Lid: PC

Duct connectors: ABS

Tubing: PVC

Protection standard:

IP54

Display (Optional)

Line 1: 2-line display (12 characters/line)

Line 2: active measurement

Line 2: units

Electrical connections:

4-screw terminal block

Wire: 0.2–1.5 mm² (12–24 AWG)

Cable entry: M16

Pressure fittings:

Male \varnothing 5,2 mm

+ High pressure

– Low pressure

WARNING

- READ THESE INSTRUCTIONS CAREFULLY BEFORE ATTEMPTING TO INSTALL, OPERATE OR SERVICE THIS DEVICE.
- Failure to observe safety information and comply with instructions can result in PERSONAL INJURY, DEATH AND/OR PROPERTY DAMAGE.
- To avoid electrical shock or damage to equipment, disconnect power before installing or servicing and use only wiring with insulation rated for full device operating voltage.
- To avoid potential fire and/or explosion do not use in potentially flammable or explosive atmospheres.
- Retain these instructions for future reference.
- This product, when installed, will be part of an engineered system whose specifications and performance characteristics are not designed or controlled by HK Instruments. Review applications and national and local codes to assure that the installation will be functional and safe. Use only experienced and knowledgeable technicians to install this device.

Electrical

Voltage:

Circuit: 3-wire (V Out, 24 V, GND)

Input: 24 VAC or VDC, \pm 10 %

Output: 0–10V / 2–10V

Power consumption: <1.0 W,

Resistance minimum: 1 k Ω

Current:

Circuit: 3-wire (mA Out, 24 V, GND)

Input: 24 VAC or VDC, \pm 10 %

Output: 4–20 mA

Power consumption: <1.2 W,

Maximum load: 500 Ω

Minimum load: 20 Ω

Conformance

Meets the requirements for CE marking:

EMC Directive 2014/30/EU

RoHS Directive 2011/65/EU

WEEE Directive 2012/19/EU

COMPANY WITH
MANAGEMENT SYSTEM
CERTIFIED BY DNV GL
= ISO 9001 = ISO 14001 =



SCHEMATICS

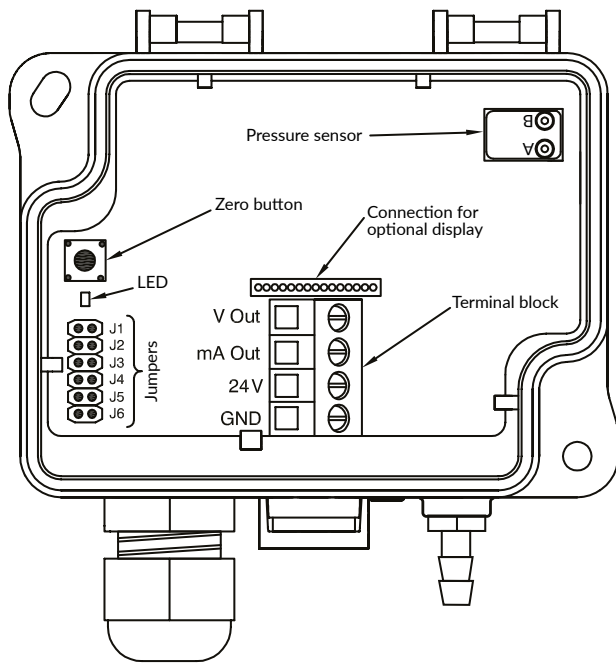

DIMENSIONAL DRAWINGS

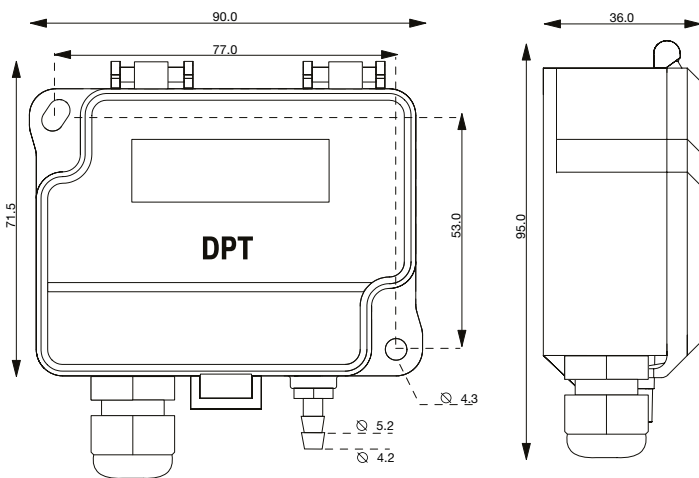

INSTALLATION

- 1) Mount the device in the desired location (see step 1).
- 2) Open the lid and route the cable through the strain relief and connect the wires to the terminal block(s) (see step 2).
- 3) The device is now ready for configuration.

⚠ WARNING! Apply power only after the device is properly wired.

STEP 1: MOUNTING THE DEVICE

- 1) Select the mounting location (duct, wall, panel).
- 2) Use the device as a template and mark the screw holes.
- 3) Mount with appropriate screws.

Figure 1a - Surface mounting

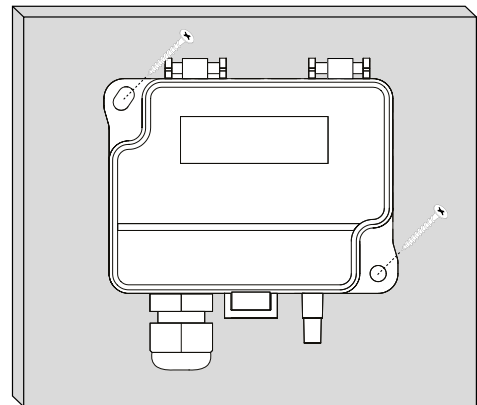

Figure 1b - Mounting orientation

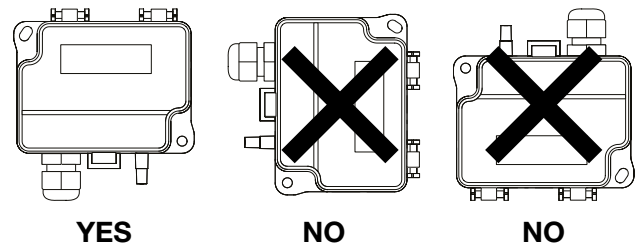
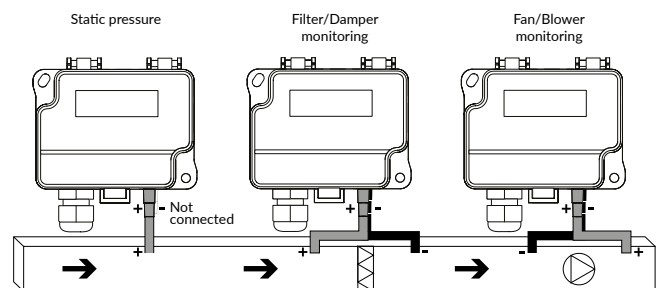

Figure 1c - Application connections



STEP 2: WIRING DIAGRAMS

For CE compliance, a properly grounded shielding cable is required.

- 1) Unscrew the strain relief and route the cable(s).
- 2) Connect the wires as shown in figure 2a and 2b.
- 3) Tighten the strain relief.

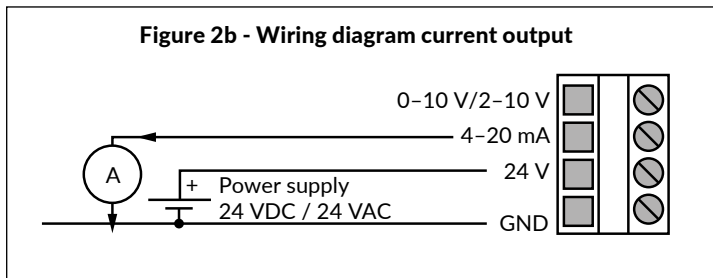
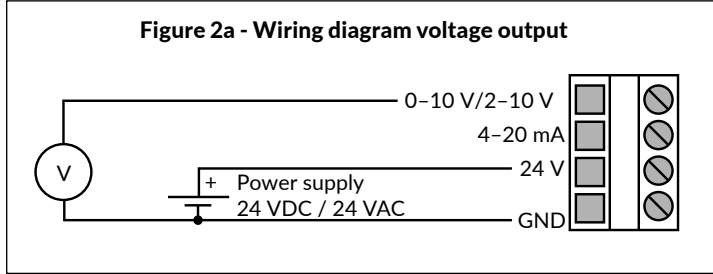

STEP 3: CONFIGURATION

- 1) Select the desired measurement unit. (see step 4)
- 2) Select the desired measurement range. (see step 5)
- 3) Select the desired response time. (see step 6)
- 4) Select the desired voltage output. (see step 7)
- 5) Zero the device. (see step 8)
- 6) Connect the pressure tubes. Connect positive pressure to port labeled "+" and negative pressure to port "-".
- 7) Close the lid. The device is now ready to be used.

STEP 4: SELECTING THE MEASUREMENT UNIT

- 1) To change the measurement unit appearing on the display, install a jumper to both pins of J5 (see Figure 3).
- 2) Push down the zero button and the measurement unit options (Pa, kPa, mbar, inchWC, mmWC, psi) will cycle on the display.
- 3) To select a unit option to display, remove the jumper from J5 while the measurement unit is visible on the display.

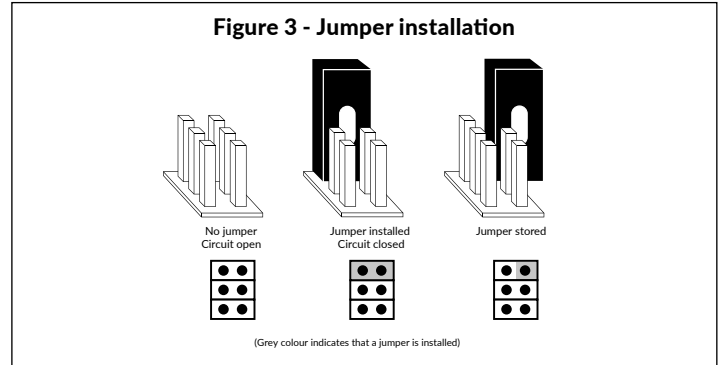

STEP 5: SELECTING THE MEASUREMENT RANGE

- 1) Determine the range number
 - a. Find the model in Chart 1.
 - b. Find the measurement unit (selected in step 4).
 - c. Find the required measurement range on the same line as the measurement unit (b above) and determine the range number in the header.
- 2) Install jumpers on J1, J2 and J3 as required.
 - a. Using the range number from 1c above, find the corresponding range number in Chart 2.
 - b. Install jumpers on J1, J2 and J3 on device, as shown under the range number in Chart 2. (Grey colour indicates that a jumper is installed. Reference figure 3 for jumper installation.)

Chart 1

Model DPT-Priima	Range 1	Range 2	Range 3	Range 4	Range 5	Range 6	Range 7	Range 8
Pa	-25-25	-50-50	-100-100	-500-500	0-25	0-50	0-250	0-1000
kPa	-0.025-0.025	-0.05-0.05	-0.1-0.1	-0.50-0.50	0-0.025	0-0.05	0-0.25	0-1.00
mbar	-0.25-0.25	-0.50-0.50	-1.00-1.00	-5.00-5.00	0-0.25	0-0.50	0-2.50	0-10.0
inchWC	-0.10-0.10	-0.20-0.20	-0.40-0.40	-2.01-2.01	0-0.10	0-0.20	0-1.00	0-4.01
mmWC	-2.6-2.6	-5.1-5.1	-10.2-10.2	-51.0-51.0	0-2.6	0-5.1	0-25.5	0-102.0
psi	-0.0036-0.0036	-0.0073-0.0073	-0.0145-0.0145	-0.0725-0.0725	0-0.0036	0-0.0073	0-0.0363	0-0.1450

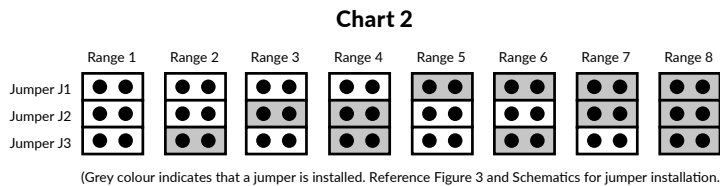

STEP 6: SELECTING THE RESPONSE TIME

The response time affects how fast the transmitter reacts to changes in the system. The response time is the time the device takes to reach 63 % of the measured value. To smooth out unstable pressure fluctuations in airflow applications, select a longer response time.

Example:

Selected response time: 8.0 seconds

Result: Output signal achieves a new value in 40 seconds (Response time*5)

To change response time, install or remove jumper on J4. (see Figure 3)

- 1) Install jumper on J4 for 8.0 second response time.
- 2) Remove jumper from J4 for 0.4 second response time.

STEP 7: USING 2-10 V OUTPUT

In some applications it is critical to know immediately if the wire is broken or the device is damaged. In these cases, a 2-10 voltage output is recommended.

- 1) Install jumper on J6 for 2-10 voltage output
- 2) Remove jumper from J6 for 0-10 voltage output

NOTE! When using current output J6 circuit must be open!

STEP 8: ZEROING THE DEVICE

NOTE! Always zero the device before use.

To zero the device two options are available:

- 1) Autozero calibration (manual zeroing not required)
- 2) Manual Pushbutton zero point calibration

1) Autozero calibration

Autozero calibration (-AZ) is an autozero function in the form of an automatic zeroing circuit built into the PCB board. The autozero calibration electronically adjusts the transmitter zero at predetermined time intervals (every 10 minutes). The function eliminates all output signal drift due to thermal, electronic or mechanical effects, as well as the need for technicians to remove high and low pressure tubes when performing initial or periodic transmitter zero point calibration. The autozero adjustment takes 4 seconds after which the device returns to its normal measuring mode. During the 4 second adjustment period, the output and display values will freeze to the latest measured value.

Transmitters equipped with the autozero calibration are virtually maintenance free and manual zeroing is not required.

ZEROING THE DEVICE CONTINUED

2) Manual Pushbutton zero point calibration

NOTE: Supply voltage must be connected at least one hour prior to zero point adjustment.

- a) Disconnect both pressure tubes from the pressure ports labeled + and -.
- b) Push down the zero button until the LED light (red) turns on and the display reads "zeroing" (display option only). (see Figure 4)
- c) The zeroing of the device will proceed automatically in 4 seconds. Zeroing led lights only for a moment. Zeroing is complete when the display reads 0 (display option only).
- d) Reinstall the pressure tubes ensuring that the High pressure tube is connected to the port labeled +, and the Low pressure tube is connected to the port labeled -.

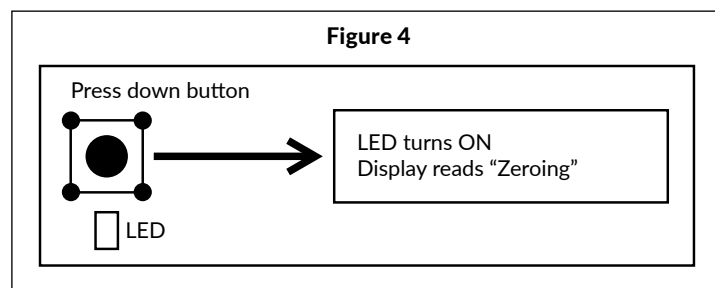

RECYCLING/DISPOSAL

The parts left over from installation should be recycled according to your local instructions. Decommissioned devices should be taken to a recycling site that specializes in electronic waste.



WARRANTY POLICY

The seller is obligated to provide a warranty of five years for the delivered goods regarding material and manufacturing. The warranty period is considered to start on the delivery date of the product. If a defect in raw materials or a production flaw is found, the seller is obligated, when the product is sent to the seller without delay or before expiration of the warranty, to amend the mistake at his/her discretion either by repairing the defective product or by delivering free of charge to the buyer a new flawless product and sending it to the buyer. Delivery costs for the repair under warranty will be paid by the buyer and the return costs by the seller. The warranty does not comprise damages caused by accident, lightning, flood or other natural phenomenon, normal wear and tear, improper or careless handling, abnormal use, overloading, improper storage, incorrect care or reconstruction, or changes and installation work not done by the seller. The selection of materials for devices prone to corrosion is the buyer's responsibility, unless otherwise is legally agreed upon. Should the manufacturer alter the structure of the device, the seller is not obligated to make comparable changes to devices already purchased. Appealing for warranty requires that the buyer has correctly fulfilled his/her duties arisen from the delivery and stated in the contract. The seller will give a new warranty for goods that have been replaced or repaired within the warranty, however only to the expiration of the original product's warranty time. The warranty includes the repair of a defective part or device, or if needed, a new part or device, but not installation or exchange costs. Under no circumstance is the seller liable for damages compensation for indirect damage.