

» LCF02 Touch 5DO

Fancoil controller

thermokon[®]
HOME OF SENSOR TECHNOLOGY

Datasheet

Subject to technical alteration
Issue date: 11.08.2020 • A110



» APPLICATION

The fancoil room controller has been designed for individual control of temperature in commercial, industrial and residential buildings. With its flush mounted modern design the device combines digital technology with a large LCD display and additional buttons, which enables the single room controller to be used intuitively.

» SECURITY ADVICE – CAUTION



The installation and assembly of electrical equipment should only be performed by authorized personnel.

The product should only be used for the intended application. Unauthorised modifications are prohibited! The product must not be used in relation with any equipment that in case of a failure may threaten, directly or indirectly, human health or life or result in danger to human beings, animals or assets. Ensure all power is disconnected before installing. Do not connect to live/operating equipment.



CAUTION! Risk of electric shock due to live components within the enclosure, especially devices with mains voltage supply (usually between 90..265 V).

Please comply with

- Local laws, health & safety regulations, technical standards and regulations
- Condition of the device at the time of installation, to ensure safe installation
- This data sheet and installation manual

» NOTES ON DISPOSAL



As a component of a large-scale fixed installation, Thermokon products are intended to be used permanently as part of a building or a structure at a pre-defined and dedicated location, hence the Waste Electrical and Electronic Act (WEEE) is not applicable. However, most of the products may contain valuable materials that should be recycled and not disposed of as domestic waste. Please note the relevant regulations for local disposal.

» REMARKS TO ROOM SENSORS

Location and Accuracy of Room Sensors

The room sensor should be mounted in a suitable location for measuring accurate room temperature. The accuracy of the temperature measurement also depends directly on the temperature dynamics of the wall. It is important, that the back plate is completely flush to the wall so that there is sufficient circulation of air through the vents in the cover, otherwise, deviations in temperature measurement will occur due to uncontrolled air circulation. The temperature sensor should not be covered by furniture or other objects. Mounting next to doors (due to draught) or windows (due to colder outside wall) should be avoided.

Surface and Flush Mounting

The measuring result is influenced by the thermal characteristics of the wall. A solid concrete wall responds to thermal fluctuations within a room in a much slower than a light-weight structure wall. Room temperature sensors installed in flush-mounted boxes have a longer response time to thermal variations. In extreme cases they detect the radiant heat of the wall even if the air temperature in the room is lower for example. The quicker the dynamics of the wall (temperature acceptance of the wall) or the longer the selected inquiry interval of the temperature sensor is the smaller the deviations limited in time are.

» TECHNICAL DATA

Measuring values	temperature		
Output switch contact	terminal 2 3 (for heating/cooling 2-point control or PWM) 2 normally open contacts, max. 250 V ~ / 3 A max. 30 V = / 3 A	terminal 5 6 7 – LO ME HI (for Fan) 3x normally open contact, max. 250 V ~ / 3 A max. 30 V = / 3 A	
Network technology	RS485 Modbus, RTU, half-duplex, baud rate 4.800, 9.600, 19.200 or 38.400, parity: non (2 stopbits), even or odd (1 stopbit)		
Power supply	24 V = (±10%) 24 V ~ (±20%) SELV		
Power consumption	3 W (24 V =)		
Measuring range temp.	+1..+50 °C		
Accuracy temperature	±1 K (typ. at 21 °C)		
Inputs	terminal 10 input for external sensor NTC10K	terminal 11 – ESI DP input digital for floating contact, window contact, dew point sensor	terminal 12 - OCC input digital for floating contact, occupancy sensor, key card switch
Control functions	set point adjustment +1..+50 °C, (default +16..+30 °C)		
Display	LCD 64x41 mm, white or black background lighting		
Enclosure	ABS, pure white or black		
Protection	IP20 according to EN 60529		
Cable entry	rear entry		
Connection electrical	terminal block max. 1,5 mm ²		
Ambient condition	-10..+50 °C, max. 95% rH non-condensing		
Mounting	flush mounted with standard EU box (Ø=60 mm)		

Communication Modbus

Communication-section	1..247	Factory default: 1
Address 0	broadcast address	
Communication-Interface	RS485	
Communication-Protocol	Modbus-RTU	
Baud Rate	4800 bps / 9600 bps / 19200 bps / 38400 bps (optional)	Factory default: 9600bps
Parity	no parity / odd parity / straight parity (optional)	Factory default: no parity
Data:	8 bit	
Stop	2 bit	

» **PRODUCT TESTING AND CERTIFICATION**



Declaration of conformity

The declaration of conformity of the products can be found on our website <https://www.thermokon.de/>.

» **CONNECTION PLAN**

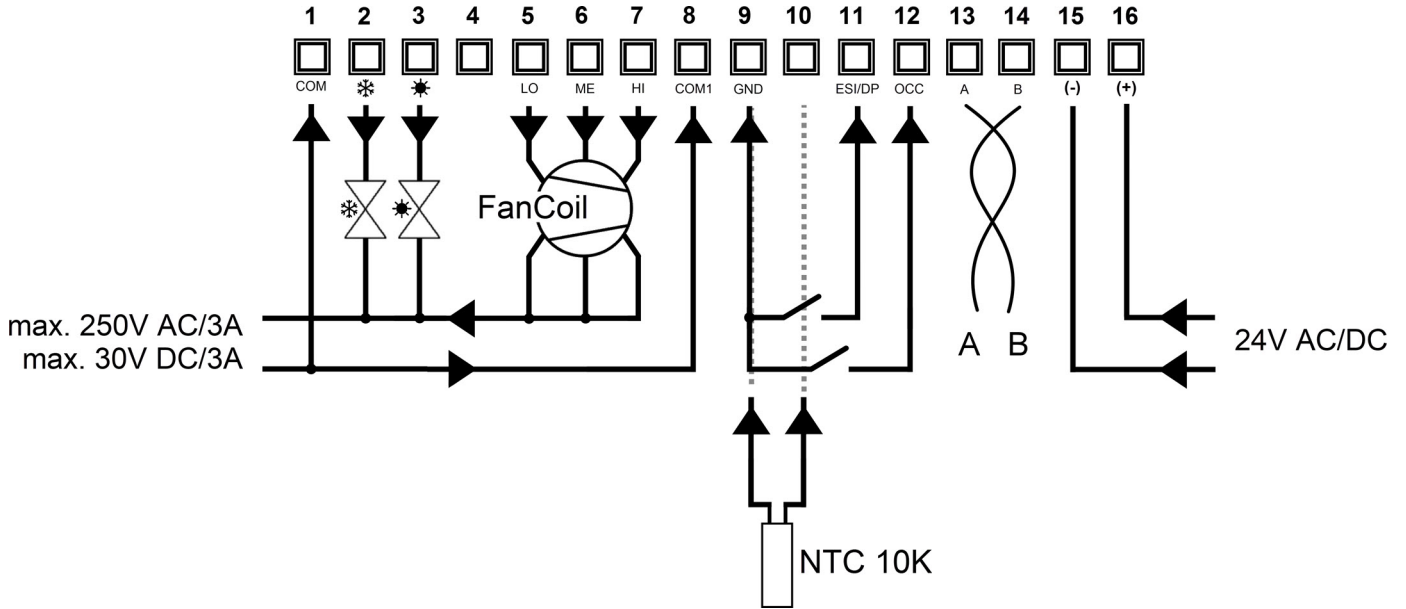

Power supply

When several BUS devices are supplied by one 24 V AC voltage supply, it is to be ensured that all “positive” operating voltage input terminals (+) of the field devices are connected with each other and all “negative” operating voltage input terminals (-) (=reference potential) are connected together (in-phase connection of field devices).

In case of reversed polarity at one field device, a supply voltage short-circuit would be caused by that device. The consequential short-circuit current flowing through this field may cause damage to it.

Therefore, pay attention to correct wiring.

Controller output signal

		4-pipe (default)	2-pipe
Terminal 2	❄️	Cooling	Heating & Cooling
Terminal 3	☀️	Heating	

» DISPLAY PANEL

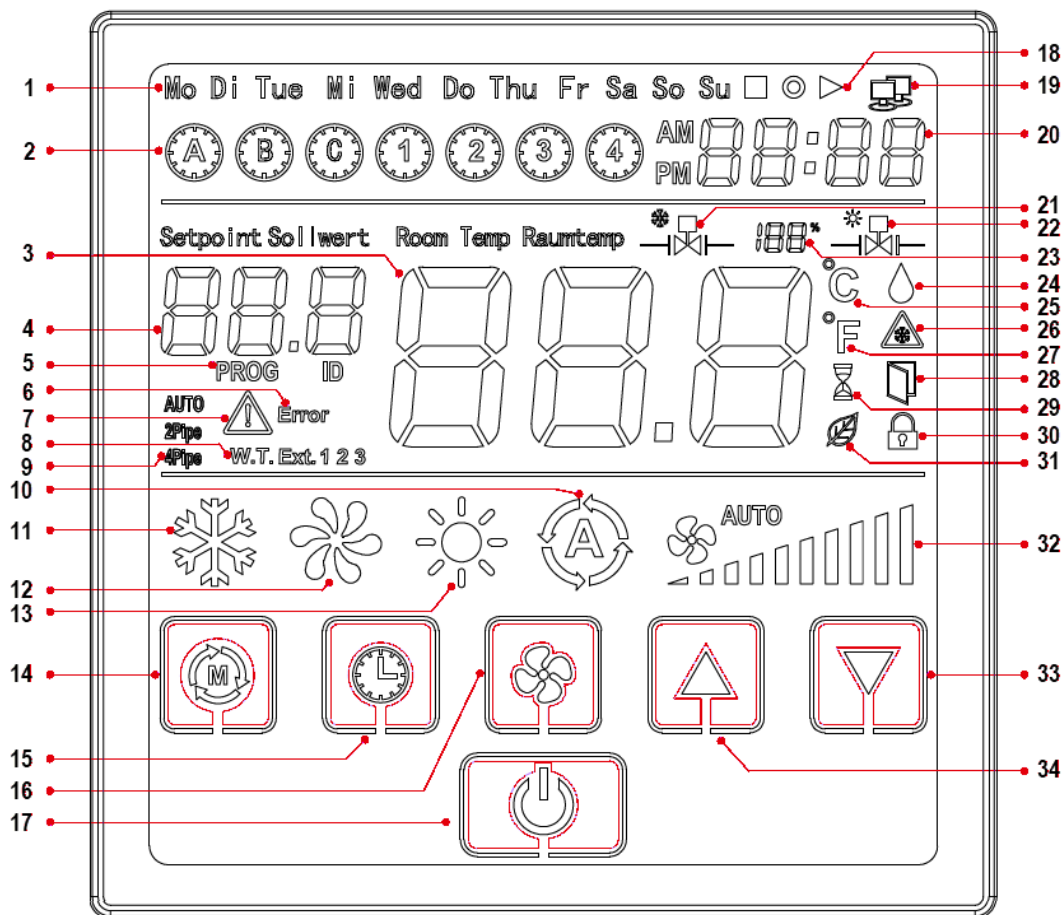

- 1 Week
- 2 Scheduler
- 3 Room temperature
- 4 Setpoint
- 5 Program
- 6 Error
- 7 Attention sign
- 8 External sensor used
- 9 Fan coil type
- 10 Auto mode
- 11 Cooling
- 12 Ventilation
- 13 Heating
- 14 Mode key
- 15 Clock setting
- 16 Set fan speed
- 17 Power ON/OFF
- 18 Power-On options
- 19 Modbus active
- 20 Clock
- 21 Cooling valve
- 22 Heating valve
- 23 Valve opening
- 24 Dew point
- 25 Celcius
- 26 Frost protection off
- 27 Fahrenheit
- 28 Window open
- 29 Off-delay active
- 30 Key locked
- 31 Eco-Mode active
- 32 Fan stage
- 33 Temperature down
- 34 Temperature up

» FUNCTION DESCRIPTION

During device start-up the version and type number are displayed on the start screen for a short time.



While the fan coil thermostat is communicating via the bus, the communication symbol starts flashing. If the device does not communicate via the bus, the symbol will disappear after 10 seconds.

Parameter table

To enter the parameter table, press the "Mode" + "arrow upwards" Key for more than 3s. Once the Display comes on, it will prompt for the password (default 987). The password can be entered digit by digit. Each digit can be increased / decreased using the "▲" or "▼" keys. With the "Mode Key" the next digit will be selected.

Each parameter can be increased / decreased using the "▲" or "▼" keys. With the "Mode Key" the display will move on to the next parameter. Once the end of the table is reached the parameter setting will be exited to normal operation.

No.	Name of parameter	Parameter definition	Factory default
1	Modbus address	ID.1- ID.247	1
2	Baud rate	1:4800bps,2:9600,3:19200,4:38400	2
3	Parity	0:none, 1:odd 2:even	0
4	Stop Bits	1 = 1 Stopbit; 2, = 2 Stopbits	2
5	Temperature Offset <i>Internal Sensor</i>	-5,0 K..+5,0 K	0
6	Temperature Offset <i>External Sensor</i>	-5,0 K..+5,0 K	0
7	Screensaver mode	0- display button on / off 1-room temperature and button on / off 2- display clock, room temperature and button on / off 3- display clock, room temperature / button on / off and set point 4- display all status	0
8	7day 4periods programmable	0=deactivated 1=activated	0
9	Password	0..999	987
10	Reset to Factory Settings	Setting Parameter to 1 and press the Mode Key resets the device to factory settings. Device stays in Parameter menu for Modbus configuration	0
11	reserved	reserved	0

The Fancoil controller is designed for fan coil units with 2- or 4-pipe systems for heating and cooling.

Heating/ cooling with 2-point-/ 3-point-controller (Register address 0x0130)

In the case of temperature control, the 2-point controller only knows the switching states heating ON and heating OFF. The 3-point controller also knows the switching state of cooling. Two - and three-point controller work with a hysteresis.

Heating/ cooling with PI-controller (PWM) (Register address 0x0130)

The time response of the PI control loop depends on the control parameters x_p for the proportional area and t_n for the reset time of the integral range. In case of an error, the P portion immediately changes the position value proportionally to the error variable, while the integral portion takes effect after a certain time. The resulting actuating variable is output as a pulse-width-modulated signal directly to the outputs.

Operating mode

Press the "Mode Key" , to adjust the mode cyclically (Cooling > Ventilating > Auto mode > Heating ...).

In 2-pipe configuration not available modes (depending on the change-over sensor's signal) will be skipped. In this case the user can select the available modes only.

Standby / ECO / ON

The Power-Button switches the device from Stand-by to ON. In Standby the display is off, but the control loop is actively monitoring the temperature and will activate the heating output if the room temperature drops below the frost protection threshold.

Pressing the button once switches the display on and the device to ECO mode. In ECO mode it controls the room temperature to the setpoint predefined by register 275 and 276 (0x0113, 0x0114). The display will show the average of both ECO Setpoint Temperatures ($25+18/2=21,5$) and the leaf symbol to indicate the ECO mode. In ECO mode the setpoint is fixed and the device does not react to any button pressed by the user besides pressing the Stand-by/ECO/ON button a 2nd time. Then it will switch from ECO to comfort mode. To indicate that the Fancoil thermostat is in ECO mode it will show the leaf and the word ECO in the display.

In case an occupancy sensor is connected to one of the inputs the mode will change from ECO to comfort as soon as the input becomes active and the previously used Setpoint will be restored and the leaf symbol will not be showing any more.

Temperature sensor input – temperature limiter and external sensor

The temperature sensor input (address 0x0152) can be used as change over sensor (addresses 0x012B and 0x012C) or as external temperature sensor.

Furthermore, it can also be used to limit the heating temperature (address 0x010A) and cooling temperature (address 0x010B). This is the case for floor heating systems, where the external sensor is embedded in the floor. In case the floor temperature will exceed a certain threshold the heating valve shall be closed to avoid damaging the floor or the pipes embedded in the floor.

Fan control

If the fan is configured to be 1-stage or 2-stage the selection will be adapted accordingly. In „ventilating mode“, the valves will be closed. If the fan speed  is set to Auto the steps are switched depending on the temperature difference between the setpoint value and the current temperature value.

In auto mode heating or cooling, the fan level is calculated from the output of the PI loop (control variable).

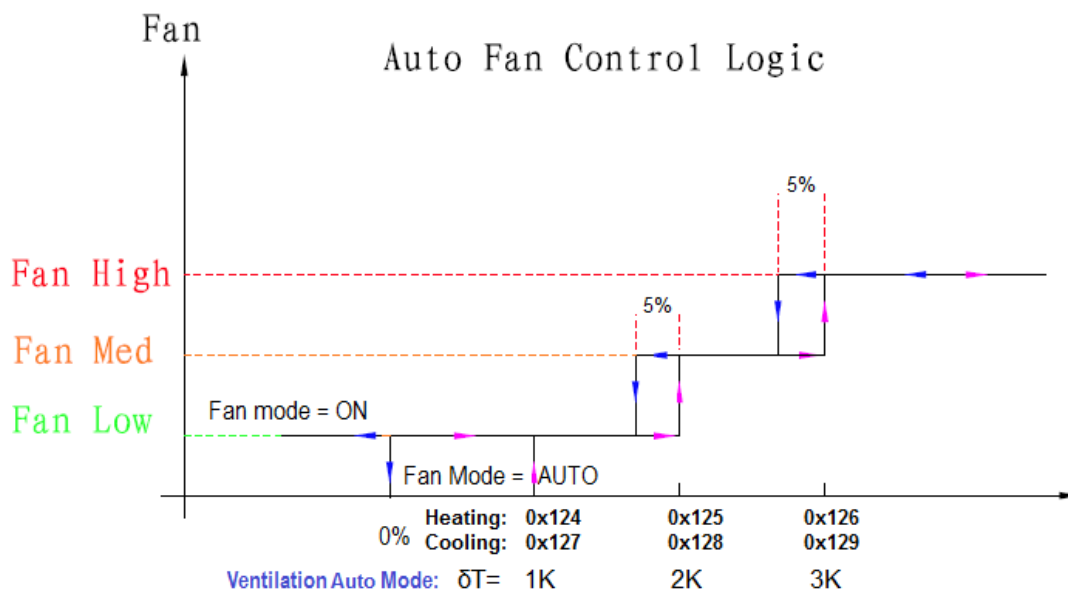

°F/°C selective

Temp display range is +30 °F..99 °F, respectively 0 °C..50 °C (factory default is °C). By simultaneously pressing the keys "▲" and "▼" the display of the unit system can be switched directly on the LCD.

Temperature offset correction (Register address 0x0106)

The internal sensor will be affected by the Thermostat's self-heating. As a consequence it would display a higher room temperature than the average of indoor temperature (real value). Item 5 & 6 of the parameter table does contain the correction of temperature offset (resolution 0,1 °C).

Set the Temperature set point range (Register address 0x0110 – 0x0112)

Press "▲" or "▼" key to adjust the temperature set point range. Factory default (°C) is 16 °C..30 °C.

Key lock selection (Register address 0x010D)

If a key is pressed that is locked, the lock symbol  will appear for 2s and blink 2x but no further action is taken.

Power failure – Restart selection (Register address 0x010C)

On the LCD, there are three symbols    that define how the thermostat will restart after a power failure:



Keep thermostat switched OFF



Switch thermostat to last state before power failure (Record and Memorize)



Turn the thermostat ON

Storage during power loss

The status will be kept in EEPROM, while the power failure, so no data will be lost.

The setpoint is not saved. The standard setpoint after power-on reset applies, register address 271 (0x010F).

Occupancy (OCC)

If the input is configured for an Occupancy sensor. If the sensor indicates "UnOccupied" the current setpoint will be replaced by the Eco Mode Setpoint Temp. The display will show the leaf symbol and the lettering ECO to indicate the ECO mode. Once the room occupancy is detected again the previously used Setpoint will be restored and the leaf symbol will not be showing any more.

Window contact (ESI)

If the input is configured as window contact, the "Window open" Symbol will be displayed the thermostat will check every 3 seconds the input whether active. The cooling valve will be closed as long as the input will be active. The rest of the thermostat will work as usual, the user may

change the setpoint or the fan stage, but the valve outputs will remain in valve closed position. If configured the "Window open"  or the Dew

Point symbol  will be flashing. When the input will not be active, the thermostat's outputs return to normal operation and operates the outputs normally.

Sensor failure alarm

In case the room NTC temp sensor is open or short, thermostat switches fan to medium and the valve to 50% (5V output, 50% duty cycle for PWM and ON/OFF). The display will show (blinking) error code: "E1" Thermostat will allow to control fan manually as well as the valve output using the "▲" or "▼" keys. Every operation of the "▲" or "▼" keys will decrement / increment the output voltage by 1V = 10% AND the PWM by 10%. The percentage is shown in the display.

Input Register

Address		Access	Description	Resolution / Unit	
0	0x0000	Read-only	Thermokon Model identification 0xFF10 = LCF Touch 02-5DO		
1	0x0001	Read-only	Firmware-Version e.g. 0x1A20 = 1.10.2.0		
2	0x0002	Read-only	Back-Box type 05 = 5DO		
3	0x0003	Read-only	Value of the integrated temperature sensor °C/°F 0...500 = 0..+50,0 °C	0,1	°C
4	0x0004	Read-only	fan status 0b00000000 = OFF 0b00000001 = Stage Low 0b00000010 = Stage Medium 0b00000100 = Stage High 0b00001000 = Auto OFF 0b00001001 = Auto Low 0b00001010 = Auto Medium 0b00001100 = Auto High		
5	0x0005	Read-only	VA1 status 0-100 0 = 0 (Off) ...100% (On), e.g. 693 = 69,3% of PWM cycle time ON		
6	0x0006	Read-only	VA2 status 0-100 0 = 0 (Off) ...100% (On), e.g. 693 = 69,3% of PWM cycle time ON		
8	0x0008	Read-only	external temperature sensor °C/°F -200...+1000 = -20,0..+100,0 °C	0,1	°C/°F
9	0x0009	Read-only	failure status 0x00=no failure 0x01= control loop temperature sensor alarm 0x02=external temperature sensor high limit Alarm 0x04=external temperature sensor low limit Alarm 0x08= change over sensor missing alarm		
10	0x000A	Read-only	External input 1 0 = Contact Open, 1= contact closed (for window contact, dew point sensor)		
11	0x000B	Read-only	External input 2 0 = Contact Open, 1= contact closed (for OCC-sensor, keycard Switch)		

Holding Register

General settings						
Address		Access	Description	Resolution / Unit		Default
256	0x0100	Read-write	Customer set Device location identification 0...65535	1.0		1
257	0x0101	Read-write	LCD Temperature Unit 0=°C 1=°F			0
258	0x0102	Read-write	Beeper Intensity 0=Off 1..5 (Volume)			5
259	0x0103	Read-write	Backlight intensity operated 0..100	1.0	%	80
260	0x0104	Read-write	Backlight intensity for screen saver (Parameter 7) 0..25			20
261	0x0105	Read-write	Backlight operating delay setting 1...255 = 1...255 seconds ON	1.0	s	15
262	0x0106	Read-write	Internal Sensor Temperature Offset (added to measured value) -50...50 = -5,0..+5,0 °C	0.1	°C/°F	0
263	0x0107	Read-write	external Sensor Temperature Offset (added to measured value) -50..+50 = -5,0..+5,0 °C	0.1	°C/°F	0
264	0x0108	Read-write	Display language 0= German 1= English 2= no wording			0
265	0x0109	Read-write	Individual passwords setting 001-999, default=987, 000 = no password			987

266	0x010A	Read-write	External temperature (limiter) sensor high limit (338=3, for limiter) -200..+1000 = -20,0...+100,0 °C	0.1	°C/°F	40°C
267	0x010B	Read-write	External temperature (limiter) sensor low limit (338=3, for limiter) -200..+1000 = -20,0...+100,0 °C	0.1	°C/°F	0°C
268	0x010C	Read-write	Power failure 0=keep off after power-on-reset 1=return to last state after power failure 2=switch on after power-on-reset			1
269	0x010D	Read-write	Key-lock 0x00=unlocked 0x01=lock on/off 0x02=lock mode 0x04=lock clock 0x08=lock fan speed 0x10=lock temp setting 0x1F=lock all keystrokes Once a locked key is pressed the LOCK symbol shall be displayed and blink twice.			0
270	0x010E	Read-write	Display Settings 0b00000001= show Setpoint (if no setpoint is shown the setpoint keys are locked = 0x010D = 0x10=lock temp setting) 0b00000010= show Room temperature 0b00000100 = show valve symbol 0b00001000 = show PI-Loop percentage 0bxxx10000 = show Room temperature from Register 0x205 (if only room temp or setpoint is shown, then in big numbers)			15

Set point settings

Address	Access	Description	Resolution / Unit		Default
271	0x010F	Default Setpoint after Power On Reset 0..500 = 0...50,0 °C	0.1	°C/°F	210
272	0x0110	Setpoint temperature lower limit 0..500 = 0..50,0 °C	0.1	°C/°F	160
273	0x0111	Setpoint temperature upper limit 0..500 = 0..50,0 °C	0.1	°C/°F	300
274	0x0112	Setpoint increment/decrement value 1..100 = 0,1...10,0 °C	0.1	°C/°F	5
275	0x0113	ECO mode temperature setpoint cooling 250..450 = +25,0..+45,0 °C	0.1	°C/°F	300
276	0x0114	ECO mode temperature setpoint heating 120..240 = +12,0..+24,0 °C	0.1	°C/°F	190

PI controller						
Address	Access	Description	Resolution / Unit		Default	
277	0x0115	Read-only	Controller mode Comfort : 0b0000 0000=controller off (<i>Frost protection active</i>) 0b0000 0001=controller auto mode (<i>heating&cooling</i>) 0b0000 0010=controller heating mode only 0b0000 0011=controller cooling mode only 0b0000 0100=ventilating (<i>PI loop controls fan stages only, valves closed</i>) Controller mode ECO: 0b0001 0000=controller off (<i>Frost protection active</i>) 0b0001 0001=controller auto mode (<i>heating&cooling</i>) 0b0001 0010=controller heating mode only 0b0001 0011=controller cooling mode only 0b0001 0100=ventilating (<i>PI loop controls fan stages only, valves closed</i>) HMI mode 0b1xxx xxxx = HMI Mode, controller OFF 0b1xxx xx01 = show symbol "ventilating" 0b1xxx xx10 = show symbol "heating" 0b1xxx xx11 = show symbol "cooling" 0b1xxx x1xx = show symbol "AUTO mode" 0b1xxx x110 = show "AUTO + heating" symbol 0b1xxx x111 = show "AUTO + cooling" symbol 0b1xxx x101 = show "AUTO + ventilating" symbol 0b1xxx 1xxx = reserved			1
278	0x0116	Read-write	Fan coil type 0b00000000= 2-pipe:cooling&heating with Change-Over 0b00000001= 4-pipe:cooling&heating			1
279	0x0117	Read-write	Fan stages and operation modes 0b00000000 = none, (<i>fan key is locked and the fan symbol will not be displayed</i>) 0bxxxx0001 = single stage 0bxxxx0010 = 2 stages 0bxxxx0011 = 3 stages 0bxxxx1000 = EC Fan 0b0001xxxx = fan works not in heating mode 0b0010xxxx = fan works not in cooling/ventilation mode (<i>0b0011xxxx = fan works not in heating & cooling mode</i>)			3
280	0x0118	Read-write	Start fan at highest stage for () seconds 0...60 = 0...60 seconds	1.0	s	0
281	0x0119	Read-write	Fan OFF-Delay 0= fan never stops 1..255 = Fan stops 1...255 minutes after valves closing	1.0	min	15
282	0x011A	Read-write	PWM Cycle time 0 = for 2-point control 1...255 = PWM cycle time 1...255 minutes			15
283	0x011B	Read-write	Deadband 1...100 = 0,1...10,0 °C/°F	0.1	°C/°F	10
284	0x011C	Read-write	Heating Proportional Band Xp_heat 1...100 -> 0,1...10,0°C	0.1	°C/°F	20
285	0x011D	Read-write	Heating Integration Time Tn_heat 0...255 = 0...255 Minutes	1.0	min	30
286	0x011E	Read-write	Cooling Proportional Band Xp_cool 1...100 -> 0,1...10,0°C/°F	0.1	°C/°F	20
287	0x011F	Read-write	Cooling Integration Time Tn_cool 0...255 = 0...255 Minutes	1.0	min	30
288	0x0120	Read-write	Minimal limit of the control variable heat 0..100	1.0	%	0
289	0x0121	Read-write	Maximal limit of the control variable heat 0..100	1.0	%	100
290	0x0122	Read-write	Minimal limit of the control variable cool 0..100	1.0	%	0
291	0x0123	Read-write	Maximal limit of the control variable cool 0..100	1.0	%	100
292	0x0124	Read-write	Fan stage 1 ON threshold control variable heat 0..100	1.0	%	5
293	0x0125	Read-write	Fan stage 2 ON threshold control variable heat 0..100	1.0	%	35
294	0x0126	Read-write	Fan stage 3 ON threshold control variable heat 0..100	1.0	%	70
295	0x0127	Read-write	Fan stage 1 ON threshold control variable cool 0..100	1.0	%	5

296	0x0128	Read-write	Fan stage 2 ON threshold control variable cool 0..100	1.0	%	35
297	0x0129	Read-write	Fan stage 3 ON threshold control variable cool 0..100	1.0	%	70
298	0x012A	Read-write	Frost protection temperature threshold 50..150 = +5,0..+15,0 °C	0.1	°C/°F	70
299	0x012B	Read-write	Change-Over Temperature Threshold for Heating 0..500 = 0..+50,0 °C	0.1	°C/°F	300
300	0x012C	Read-write	Change-Over Temperature Threshold for Cooling 0..500 = 0..+50,0 °C In case temperature is in between both thresholds the last state will be maintained	0.1	°C/°F	190
304	0x0130	Read-write	Valve type selection 0= ON-OFF (ON = Valve Open, OFF = Valve Closed) 1=PWM (0%= 0%PWM .. 100% = 100% PWM) 2= OFF-ON (OFF = Valve Open, ON = Valve Closed) 3= inverted PWM (0%= 100%PWM .. 100% = 0% PWM)			0

Inputs						
Address	Access	Description	Resolution / Unit	Default		
336	0x0150	Read-write Configuration external input 1 0 = No function 1 = Occupancy sensor (Open = Occupied) 2 = Occupancy sensor (Closed =Occupied) 3 = Window contact (Open = Window Open) 4 = Window contact (Closed = Window Open) 5 = Disable heating (Open = Heating disabled) 6 = Disable heating (Closed = Heating Disabled) 7 = Disable cooling (Open = Disable Cooling) 8 = Disable cooling (Closed = Disable Cooling) 9 = Dew Point Sensor (Open = Dewpoint crossed, disable cooling) 10 = Dew Point Sensor (Closed = Dewpoint crossed, disable cooling)		0		
337	0x0151	Read-write Configuration external input 2 0 = No function 1 = Occupancy sensor (Open = Occupied) 2= Occupancy sensor (Closed =Occupied) 3 = Window contact (Open = Window Open) 4 = Window contact (Closed = Window Open) 5 = Disable heating (Open = Heating disabled) 6 = Disable heating (Closed = Heating Disabled) 7 = Disable cooling (Open = Disable Cooling) 8 = Disable cooling (Closed = Disable Cooling) 9 = Dew Point Sensor (Open = Dewpoint crossed, disable cooling) 10 = Dew Point Sensor (Closed = Dewpoint crossed, disable cooling)		0		
338	0x0152	Read-write Configuration Sensor Input 0= none 1 = Change Over Temp sensor (NTC10K) 2 = Ext. Temp sensor (NTC10K) 3 = Temperature Limiter		0		
339	0x0153	Read-write ESI (Energy Savings Input) - ON delay ON delay for ESI. Delays Energy stop by n seconds	1.0	s	0	
340	0x0154	Read-write OCC input - OFF delay 0...65535 -> 0...65535 seconds	1.0	s	1800	

Timer						
Address	Access	Description	Resolution / Unit	Default		
400	0x0190	Read-write Clock mode configuration 0=Don't show time in LCD 1=Show time 12h mode 2=show time 24h mode		2		
401	0x0191	Read-write Weekday configuration 0=Don't show the weekday in LCD 1=Show the weekday in LCD		1		
402	0x0192	Read-write Automatic Summer/winter time 0=OFF 1=EU automatic (last Sunday in March (+1h) - last Sunday in October (-1h))		1		

			2=US automatic (2nd Sunday in March (+1h) - 1st Sunday in November (-1h) 3=AUS automatic (First Sunday in October (+1h) - 1st Sunday in April (-1h) 4=BR automatic (First Sunday in November (+1h) - Third Sunday in February (-1h) 5=CHL automatic (Second Sunday in August (+1h) - Second Sunday May (-1h) 6=ISR (Friday before last Sunday in March + 1h) - Last Sunday in October (-1h) 6=MEX (First Sunday in April (+1h) - Last Sunday in October (-1)		
403	0x0193	Read-write	Time channel A weekdays 0bxxxxxx1 Bit0: Monday 0bxxxxxx1x Bit1: Tuesday 0bxxxxxx1xx Bit2: Wednesday 0bxxxx1xxx Bit3: Thursday 0bxxx1xxxx Bit4: Friday 0bxx1xxxx Bit5: Saturday 0bx1xxxxxx Bit6: Sunday		0
404	0x0194	Read-write	Time channel A period 1: Start time hour 0 – 23h	h	0
405	0x0195	Read-write	Time channel A period 1: Start time minute 0 – 59m	min	0
406	0x0196	Read-write	Time channel A period 1: Set point 0..500 = 0..+50,0 °C	0.1 °C/°F	210
407	0x0197	Read-write	Time channel A period 1: ECO mode 0b00000001=Comfort 0b00010001=ECO	NC	1
408	0x0198	Read-write	Time channel A period 2: Start time hour 0 – 23h	h	0
409	0x0199	Read-write	Time channel A period 2: Start time minute 0 – 59m	min	0
410	0x019A	Read-write	Time channel A period 2: Set point 0..500 = 0..+50,0 °C	0.1 °C/°F	210
411	0x019B	Read-write	Time channel A period 2: ECO mode 0b00000001=Comfort 0b00010001=ECO	NC	1
412	0x019C	Read-write	Time channel A period 3: Start time hour 0 – 23h	h	0
413	0x019D	Read-write	Time channel A period 3: Start time minute 0 – 59m	min	0
414	0x019E	Read-write	Time channel A period 3: Set point 0..500 = 0..+50,0 °C	0.1 °C/°F	210
415	0x019F	Read-write	Time channel A period 3: ECO mode 0b00000001=Comfort 0b00010001=ECO	NC	1
416	0x01A0	Read-write	Time channel A period 4: Start time hour 0 – 23h	h	0
417	0x01A1	Read-write	Time channel A period 4: Start time minute 0 – 59m	min	0
418	0x01A2	Read-write	Time channel A period 4: Set point 0..500 = 0..+50,0 °C	0.1 °C/°F	210
419	0x01A3	Read-write	Time channel A period 4: ECO mode 0b00000001=Comfort 0b00010001=ECO	NC	1
420	0x01A4	Read-write	Time channel B weekdays 0bxxxxxx1 Bit0: Monday 0bxxxxxx1x Bit1: Tuesday 0bxxxxxx1xx Bit2: Wednesday 0bxxxx1xxx Bit3: Thursday 0bxxx1xxxx Bit4: Friday 0bxx1xxxx Bit5: Saturday 0bx1xxxxxx Bit6: Sunday	NC	0
421	0x01A5	Read-write	Time channel B period 1: Start time hour 0 – 23h	h	0

422	0x01A6	Read-write	Time channel B period 1: Start time minute 0 – 59m		min	0
423	0x01A7	Read-write	Time channel B period 1: Set point 0..500 = 0..+50,0 °C	0.1	°C/°F	210
424	0x01A8	Read-write	Time channel B period 2: ECO mode 0b00000001=Comfort 0b00010001=ECO		NC	0
425	0x01A9	Read-write	Time channel B period 2: Start time hour 0 – 23h		h	0
426	0x01AA	Read-write	Time channel B period 2: Start time minute 0 – 59m		min	0
427	0x01AB	Read-write	Time channel B period 2: Set point 0..500 = 0..+50,0 °C	0.1	°C/°F	210
428	0x01AC	Read-write	Time channel B period 2: ECO mode 0b00000001=Comfort 0b00010001=ECO		NC	0
429	0x01AD	Read-write	Time channel B period 3: Start time hour 0 – 23h		h	0
430	0x01AE	Read-write	Time channel B period 3: Start time minute 0 – 59m		min	0
431	0x01AF	Read-write	Time channel B period 3: Set point 0..500 = 0..+50,0 °C	0.1	°C/°F	210
432	0x01B0	Read-write	Time channel B period 3: ECO mode		NC	0
433	0x01B1	Read-write	Time channel B period 4: Start time hour 0 – 23h		h	0
434	0x01B2	Read-write	Time channel B period 4: Start time minute 0 – 59m		min	0
435	0x01B3	Read-write	Time channel B period 4: Set point 0..500 = 0..+50,0 °C	0.1	°C/°F	210
436	0x01B4	Read-write	Time channel B period 4: ECO mode 0b00000001=Comfort 0b00010001=ECO		NC	0
437	0x01B5	Read-write	Time channel C weekdays 0bxxxxxx1 Bit0: Monday 0bxxxxxx1x Bit1: Tuesday 0bxxxxxx1xx Bit2: Wednesday 0bxxxx1xxx Bit3: Thursday 0bxxx1xxxx Bit4: Friday 0bxx1xxxx Bit5: Saturday 0bx1xxxxx Bit6: Sunday		NC	0
438	0x01B6	Read-write	Time channel C period 1: Start time hour 0 – 23h		h	0
439	0x01B7	Read-write	Time channel C period 1: Start time minute 0 – 59m		min	0
440	0x01B8	Read-write	Time channel C period 1: Set point 0..500 = 0..+50,0 °	0.1	°C/°F	210
441	0x01B9	Read-write	Time channel C period 1: ECO mode 0b00000001=Comfort 0b00010001=ECO		NC	0
442	0x01BA	Read-write	Time channel C period 2: Start time hour 0 – 23h		h	0
443	0x01BB	Read-write	Time channel C period 2: Start time minute 0 – 59m		min	0
444	0x01BC	Read-write	Time channel C period 2: Set point 0..500 = 0..+50,0 °C	0.1	°C/°F	210
445	0x01BD	Read-write	Time channel C period 2: ECO mode 0b00000001=Comfort 0b00010001=ECO		NC	0
446	0x01BE	Read-write	Time channel C period 3: Start time hour 0 – 23h		h	0

447	0x01BF	Read-write	Time channel C period 3: Start time minute 0 – 59m		min	0
448	0x01C0	Read-write	Time channel C period 3: Set point 0..500 = 0..+50,0 °C	0.1	°C/°F	210
449	0x01C1	Read-write	Time channel C period 3: ECO mode 0b00000001=Comfort 0b00010001=ECO		NC	0
450	0x01C2	Read-write	Time channel C period 4: Start time hour 0 – 23h		h	0
451	0x01C3	Read-write	Time channel C period 4: Start time minute 0 – 59m		min	0
452	0x01C4	Read-write	Time channel C period 4: Set point 0..500 = 0..+50,0 °C	0.1	°C/°F	210
453	0x01C5	Read-write	Time channel C period 4: ECO mode 0b00000001=Comfort 0b00010001=ECO			0
454	0x01C6	Read-write	Active Time Channel 0bABC1234 with binary value = 1 for active channel, i.e. 0x01000100 = A-2			0
464	0x01D0	Read-write	Make next day(s) holiday 0bxxx00000= None 0bxxx00001 ...0bxxx11111 days of holidays (next n- days (starting next 0:00) forces the coming 1...31 days to be treated as the day specified by the 3 MSB. Does overwrite the calendar. 0b000xxxxx = use ECO setting 0b001xxxxx = set day = Mo 0b010xxxxx = set day = Tu 0b011xxxxx = set day = Wed 0b100xxxxx = set day = Thu 0b101xxxxx = set day = Fr 0b110xxxxx = set day = Sat 0b111xxxxx = set day = Sun			0

Realtime Clock

Address		Access	Description	Resolution / Unit	Default
496	0x01F0	Read-write	system time—year 2000-2099, default=2019		2019
497	0x01F1	Read-write	system time—month 01-12		1
498	0x01F2	Read-write	system time—day 01-31		1
499	0x01F3	Read-write	system time-hour 00-23		0
500	0x01F4	Read-write	system time-minutes 00-59		0
501	0x01F5	Read-write	system time—seconds 00-59		0

Holding Register (operation to override FC from Modbus)

Address		Access	Description	Resolution / Unit	Default
512	0x0200	Read-write	Active fan speed setting 0b00000000 = OFF 0b00000001 = Stage Low 0b00000010 = Stage Medium 0b00000100 = Stage High 0b00001000 = Auto OFF 0b00001001 = Auto Low 0b00001010 = Auto Medium 0b00001100 = Auto High		0
513	0x0201	Read-write	setpoint temperature 0..500 = 0..+50,0 °C		0

514	0x0202	Read-write	<p>Controller mode Comfort : 0b0000 0000=controller off (<i>Frost protection active</i>) 0b0000 0001=controller auto mode (<i>heating&cooling</i>) 0b0000 0010=controller heating mode only 0b0000 0011=controller cooling mode only 0b0000 0100=ventilating (<i>PI loop controls fan stages only, valves closed</i>)</p> <p>Controller mode ECO: 0b0001 0000=controller off (<i>Frost protection active</i>) 0b0001 0001=controller auto mode (<i>heating&cooling</i>) 0b0001 0010=controller heating mode only 0b0001 0011=controller cooling mode only 0b0001 0100=ventilating (<i>PI loop controls fan stages only, valves closed</i>)</p> <p>HMI mode 0b1xxx xxxx = HMI Mode, controller OFF 0b1xxx xx01 = show symbol "ventilating" 0b1xxx xx10 = show symbol "heating" 0b1xxx xx11 = show symbol "cooling" 0b1xxx x1xx = show symbol " AUTO mode" 0b1xxx x110 = show "AUTO + heating" symbol 0b1xxx x111 = show "AUTO + cooling" symbol 0b1xxx x101 = show "AUTO + ventilating" symbol 0b1xxx 1xxx = reserved</p>				1
515	0x0203	Read-write	<p>Active Symbols 0x00= show none 0x01= show Leaf 0x02= show dew point 0x04= show frost protect ON 0x08= show open window 0x10= show Attention! 0x20= show hourglass 0x40= show lock 0x80= show ECO</p>				0
516	0x0204	Read-write	<p>Control Variable Y% (HMI Mode) 0-100% If output is 2-point, output will be ON for control variable >5%</p>	0.1	%		0
517	0x0205	Read-write	<p>Room temperature on LCD (HMI Mode) 0..500 = 0..+50,0 °C</p>	0.1	%		0

» MOUNTING ADVICE/ DIMENSIONS (MM)

For installing or maintenance, please make sure the power is disconnected. Fix the thermostat base plate to the wall through the four screw holes with distance between axes of 60 mm. Fasten base plate and front cover. Do not press the panel in order to protect LCD.

