

» NOVOS 3 Temp passiv

Room temperature sensor

thermokon[®]
HOME OF SENSOR TECHNOLOGY

Datasheet

Subject to technical alteration
Issue date: 05.08.2019 • A101

novos



With design cover (left), standard design w/o design cover (right)

» APPLICATION

Room sensor for recording room temperature. The sensor creates the conditions for a pleasant indoor climate and well-being. Typical applications are schools, office buildings, hotels, cinemas or similar.

» TYPES AVAILABLE

Room sensor temperature – passive

NOVOS 3 Temp <Sensor>

<Sensor>: PT100/PT1000/NI1000/NI1000TK5000/NTC10K...other sensors on request

» SECURITY ADVICE – CAUTION



The installation and assembly of electrical equipment should only be performed by authorized personnel.

The product should only be used for the intended application. Unauthorised modifications are prohibited! The product must not be used in relation with any equipment that in case of a failure may threaten, directly or indirectly, human health or life or result in danger to human beings, animals or assets. Ensure all power is disconnected before installing. Do not connect to live/operating equipment.

Please comply with

- Local laws, health & safety regulations, technical standards and regulations
- Condition of the device at the time of installation, to ensure safe installation
- This data sheet and installation manual

» NOTES ON DISPOSAL



As a component of a large-scale fixed installation, Thermokon products are intended to be used permanently as part of a building or a structure at a pre-defined and dedicated location, hence the Waste Electrical and Electronic Act (WEEE) is not applicable. However, most of the products may contain valuable materials that should be recycled and not disposed of as domestic waste. Please note the relevant regulations for local disposal.

» REMARKS TO ROOM SENSORS

Location and Accuracy of Room Sensors

The room sensor should be mounted in a suitable location for measuring accurate room temperature. The accuracy of the temperature measurement also depends directly on the temperature dynamics of the wall. It is important, that the back plate is completely flush to the wall so that the circulation of air occurs through the vents in the cover. Otherwise, deviations in temperature measurement will occur due to uncontrolled air circulation. Also the temperature sensor should not be covered by furniture or similar devices. Mounting next to doors (due to draught) or windows (due to colder outside wall) should be avoided. The temperature dynamics of the wall will influence the temperature measurement. Various wall types (brick, concrete, dividing and hollow brickwork) all have different behaviours with regards to thermal variations.

Surface and Flush Mounting

The temperature dynamics of the wall influence the measurement result of the sensor. Various wall types (brick, concrete, dividing and hollow brickwork) have different behaviours with regard to thermal variations. A solid concrete wall responds to thermal fluctuations within a room in a much slower way than a light-weight structure wall. Room temperature sensors installed in flush boxes have a longer response time to thermal variations. In extreme cases they detect the radiant heat of the wall even if the air temperature in the room is lower for example. The quicker the dynamics of the wall (temperature acceptance of the wall) or the longer the selected inquiry interval of the temperature sensor is the smaller the deviations limited in time are.

» TECHNICAL DATA

Measuring values	temperature			
Output passive (optional)	PT100 PT100 1/3 DIN PT1000 PT1000 1/3 DIN Ni1000 Ni1000TK5000, NTC10k			
Measuring range temperature	-35..+70 °C			
Accuracy temperature See „Information passive sensors“ (Link)	PT100 PT1000 ±0,3 K (typ. at 0°C, Kl.B)	Ni1000 ±0,4 K (typ. at 0 °C)	Ni1000TK5000 ±0,4 K (typ. at 0 °C)	NTC 10K ±0,22 K (typ. at 25 °C)
Sensor	2-wire, optional 4-wire			
Enclosure	PC V0, pure white, design cover (optional)			
Protection	IP20 according to DIN EN 60529			
Cable entry	Opening rear side, predetermined breaking points on underside, drill mark on top side			
Connection electrical	tool-free mountable spring terminal, max. 1,5 mm ²			
Ambient condition	-35..+70 °C, max. 85% non-condensing			
Mounting	surface mounted on flush-mounting box (Ø=60 mm) or to be mounted flat onto the surface using screws, base part can be mounted and wired separately			
Notes	other temperature sensors on request			

» PRODUCT TESTING AND CERTIFICATION



Declaration of conformity

The declaration of conformity of the products can be found on our website <https://www.thermokon.de/>.

» CONNECTION PLAN

Room sensor temperature – passive

NOVOS 3 Temp <Sensor> 2L	NOVOS 3 Temp <Sensor> 4L
Sensor- — S-  Sensor+ — S+	Sensor- — S-  Sensor- — S- Sensor+ — S+ Sensor+ — S+

» MOUNTING ADVICES

Please make sure that the device is de-energized if you want to install it!

The installation can be performed on the flat wall surface or on a flush-mounted box. A representative place should be selected. Sunshine and draft, e.g. in the installation tube should be avoided, so that the measurement result is not falsified. Seal the end of the installation tube.

- For wiring, the upper part of the device must be removed from the base plate. Base plate and upper part are detachably connected to each other by means of locking lugs.
- The mounting of the base plate on the flat wall surface is done with rawplugs and screws.
- Finally, the device is attached to the base plate and fixed with the screw.

Housing open / close

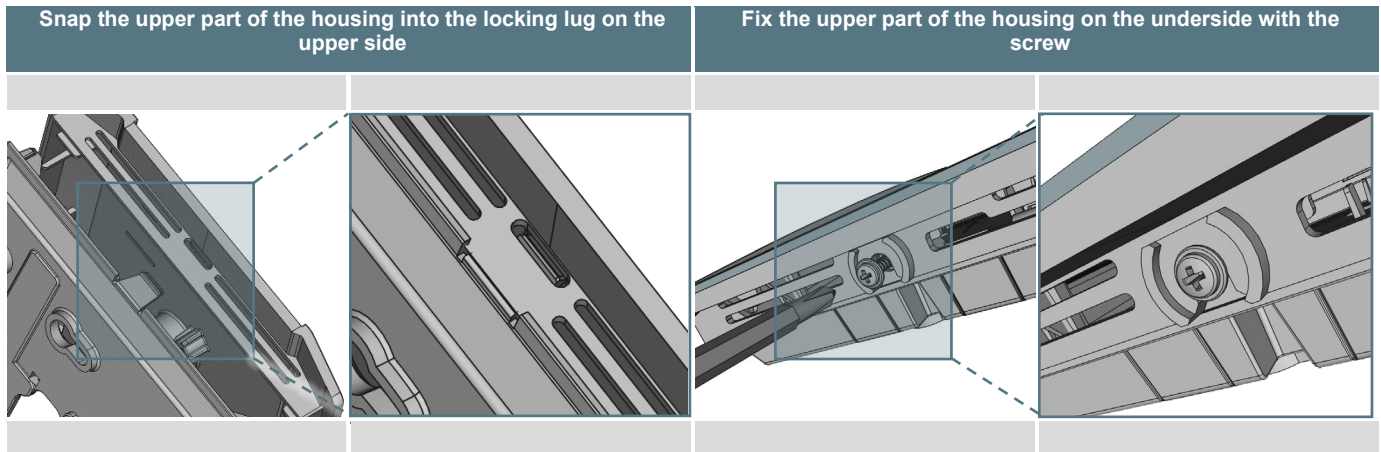

Cable entry

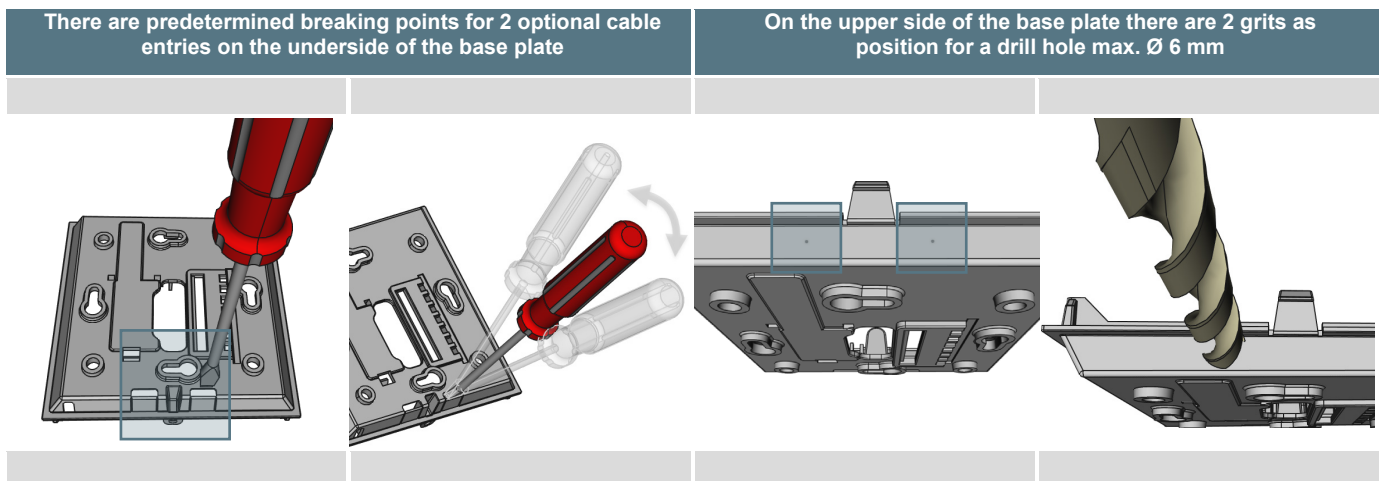

When using a drill, you should absolutely ensure that the base plate is firmly clamped. Before drilling, the pressure must be reduced and carefully drilled. A sudden break-through of the drill bit can be the result.

» DIMENSIONS (MM)

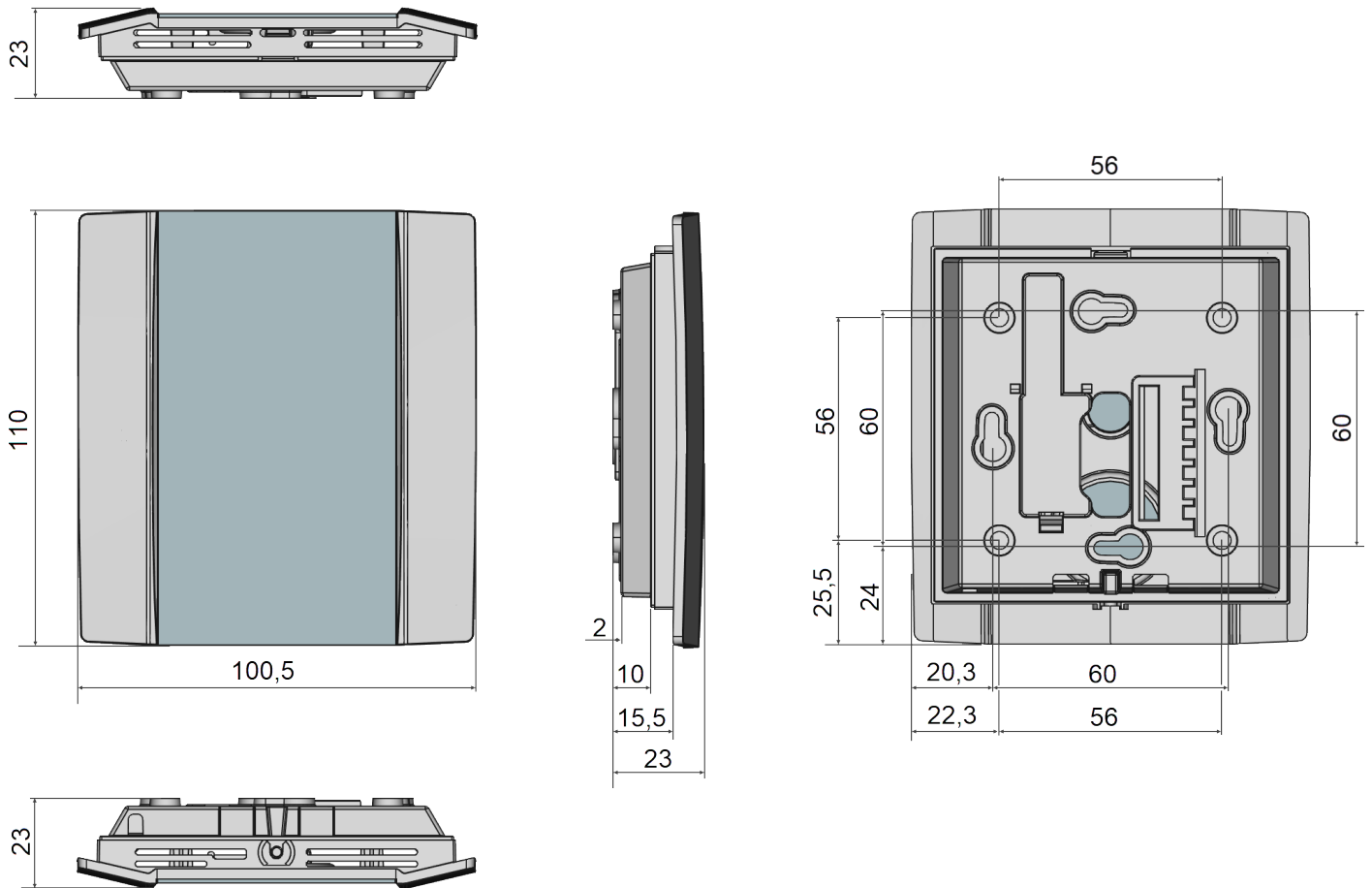

» ACCESSORIES (OPTIONAL)

Rawplugs and screws (2 pcs. each)
 Frame for surface mounting NOVOS 3

Item No.: 102209
 Item No.: 634472