

POWER CON

PCON-CB Series Controller Instruction Manual Third Edition

CB/CFB	Standard Type
CGB/CGFB	Safety Category Complied Type



IAI Corporation

Please Read Before Use

Thank you for purchasing our product.

This Instruction Manual describes all necessary information items to operate this product safely such as the operation procedure, structure and maintenance procedure.

Before the operation, read this manual carefully and fully understand it to operate this product safely.

The enclosed DVD in this product package includes the Instruction Manual for this product.

For the operation of this product, print out the necessary sections in the Instruction Manual or display them using the personal computer.

After reading through this manual, keep this Instruction Manual at hand so that the operator of this product can read it whenever necessary.

[Important]

- This Instruction Manual is original.
- The product cannot be operated in any way unless expressly specified in this Instruction Manual. IAI shall assume no responsibility for the outcome of any operation not specified herein.
- Information contained in this Instruction Manual is subject to change without notice for the purpose of product improvement.
- If you have any question or comment regarding the content of this manual, please contact the IAI sales office near you.
- Using or copying all or part of this Instruction Manual without permission is prohibited.
- The company names, names of products and trademarks of each company shown in the sentences are registered trademarks.

POWER CON **PCON-CB** --- ---

Construction of Instruction Manual for Each Controller Model and This Manual

PCON-CB/CFB
PCON-CGB/CGFB

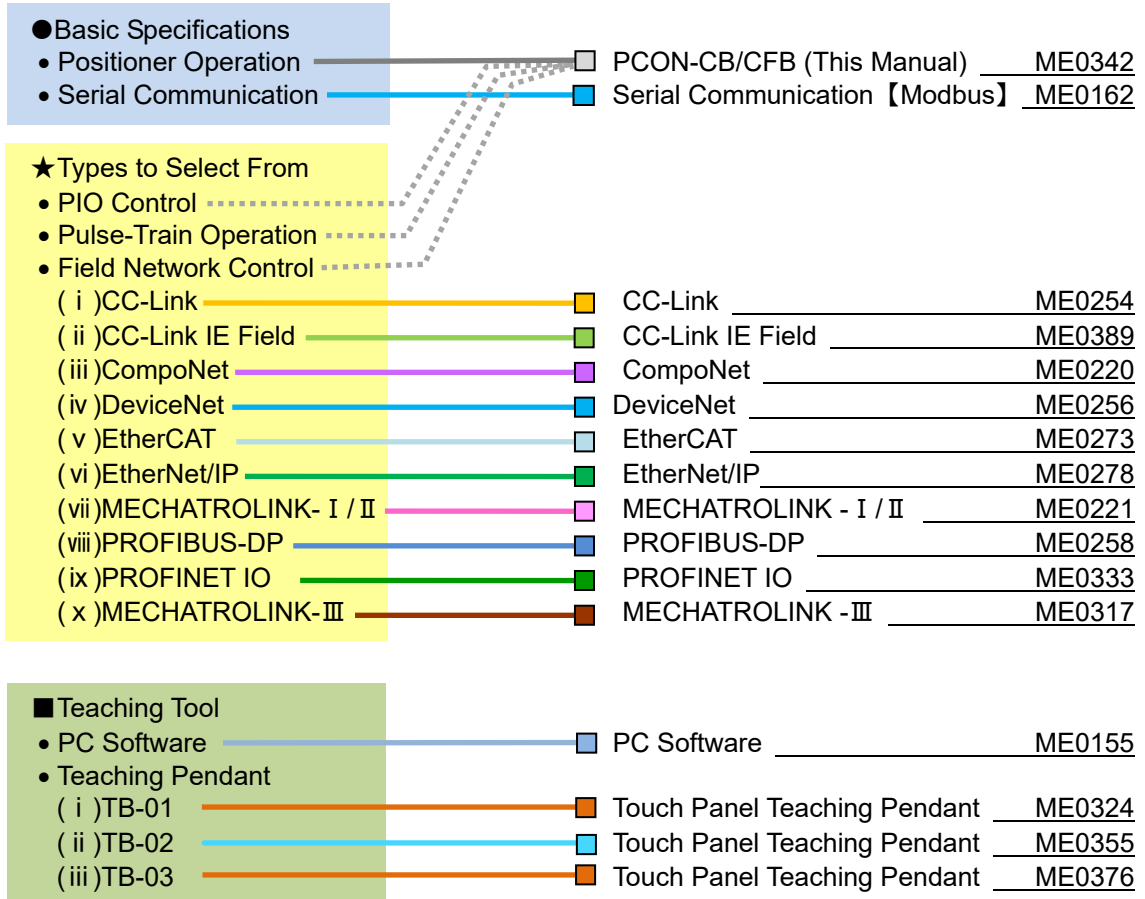

Table of Overall Contents

Name for Each Parts and Their Functions		
In this chapter, explains the name for each parts and their functions.		12
Chapter 1 Specifications Check		
In this chapter, explains the specifications of products, power capacity, model codes, etc.		19
Chapter 2 Wiring		
In this chapter, explains about the connections to actuators and external devices.		37
Chapter 3 Operation		
In this chapter, explains the comparison of operation patterns and details of each operation such as positioning and pressing operations.		
☆Position number input operation ⇒ pg. 95		
☆Operation by pulse train control ⇒ pg.149		
		71
Chapter 4 Field Network		
In this chapter, introduces the applicable field network and manual numbers for other instruction manuals.		159
Chapter 5 Other Features		
In this chapter, explains about collision detection feature, power-saving feature and actuator information manager feature.		165
Chapter 6 Absolute Reset and Absolute Battery		
In this chapter, explains the procedures for absolute reset and replacement of battery.		177
Chapter 7 Parameter		
In this chapter, explains about the controller settings.		187
Chapter 8 Troubleshooting		
In this chapter, explains how to act in errors and contents of them.		225
Chapter 9 Appendix		
In this chapter, explains compliance with safety categories, model codes of connectable actuators, etc.		247
Chapter 10 Warranty		
In this chapter, explains about the Warranty.		389

Table of Contents

Safety Guide	1
Precautions in Operation	8
International Standards Compliances	11
Name for Each Parts and Their Functions	12
Actuator Axes	16
Chapter 1 Specifications Check	19
1.1 Product Check	19
1.1.1 Parts	19
1.1.2 Teaching Tool	20
1.1.3 Instruction Manuals Related to This Product, which are Contained in the Instruction Manual (DVD)	20
1.1.4 How to Read the Model Plate	21
1.1.5 How to Read the Model	21
1.2 List of Basic Specifications	22
1.3 Appearance	24
1.3.1 CB Type •••••For Battery-less Absolute/Incremental Screw-fixed Type	24
1.3.2 CB Type •••••For Battery-less Absolute/Incremental DIN rail-fixed Type	25
1.3.3 CB Type •••••For Simple Absolute Screw-fixed Type	26
1.3.4 CB Type •••••For Simple Absolute DIN rail-fixed Type	27
1.3.5 CFB Type •••••For Incremental Screw-fixed Type	28
1.3.6 CFB Type •••••For Incremental DIN rail-fixed Type	29
1.3.7 Absolute Battery Unit (Option for Simple Absolute Type)	30
1.4 I/O Specifications	31
1.4.1 PIO Input and Output Interface	31
1.4.2 Pulse Train Input Output Interface	32
1.5 Options	33
1.5.1 Pulse converter : AK-04	33
1.6 Installation and Storage Environment	34
[1] Installation Environment	34
[2] Storage and Preservation Environment	34
1.7 Noise Elimination and Mounting Method	35
Chapter 2 Wiring	37
2.1 Positioner Mode (PIO Control)	37
2.1.1 Wiring Diagram (Connection of Devices)	37
2.1.2 PIO Pattern Selection and PIO Signal	38
2.1.3 Wiring	43
[1] Power Supply Connector (for Power Supply and Emergency Stop)	43
[2] Motor • Encoder Circuit	47
[3] Absolute Circuit (For Simplified Absolute Type Only)	47
[4] PIO Circuit	48
2.2 Pulse Train Control Mode	54
2.2.1 Wiring Diagram (Connection of Devices)	54
2.2.2 I/O Signals in Pulse Train Control Mode	55
[1] PIO Pattern 6 (Incremental Type for Actuator)	55
[2] PIO Pattern 7 (Incremental Type for Actuator)	56
2.2.3 Wiring	57
[1] Power Supply Connector (for Power Supply and Emergency Stop)	57
[2] Motor • Encoder Circuit	61
[3] PIO Circuit	62
[4] Circuits for Pulse Train Control	64

POWER CON PCON-CB

2.3	Wiring Method	65
2.3.1	Wiring Layout of Power Supply Connector.....	65
2.3.2	Connection to Actuator	66
2.3.3	Connection of PIO	67
2.3.4	Connection of Pulse Train Signal	68
2.3.5	SIO Connector Connection.....	69
Chapter 3	Operation	71
3.1	Basic Operation	71
3.1.1	Basic Operation Methods	71
3.1.2	Parameter Settings	74
3.2	Operation in Positioner Mode.....	75
[1]	PIO Pattern Selection and Main Functions	75
[2]	Overview of Major Functions.....	76
[3]	Operation Modes of Rotary Actuator in Multiple Rotation Mode and Command Limitations.....	76
3.2.1	Set of Position Table (This section is not required in selection of pulse train control mode.)	77
3.2.2	Control of Input Signal	82
3.2.3	Operation Ready and Auxiliary Signals = Common to Patterns 0 to 5.....	82
[1]	Emergency Stop Status (EMGS).....	82
[2]	Operation Mode (RMOD, RMDS)	83
[3]	Servo ON (SON, SV, PEND).....	84
[4]	Home Return (HOME, HEND, PEND, MOVE).....	85
[5]	Zone Signal and Position Zone Signal (ZONE1, ZONE2, PZONE).....	89
[6]	Alarm, Alarm Reset (*ALM, RES).....	91
[7]	Binary Output of Alarm Data Output (*ALM, PM1 to 8).....	92
[8]	Brake Release (BKRL).....	94
3.2.4	Operation with the Position No. Input = Operations of PIO Patterns 0 to 3.....	95
[1]	Positioning [Basic] (PC1 to PC**, CSTR, PM1 to PM**, PEND, MOVE, LOAD, TRQS).....	95
[2]	Speed Change During the Movement.....	100
[3]	Pitch Feeding (Relative Movement = Incremental Feed).....	101
[4]	Pressing Operation	103
[5]	Tension Operation	108
[6]	Multi-step Pressing.....	110
[7]	Teaching by PIO (MODE, MODES, PWRT, WEND, JISL, JOG+, JOG-).....	111
[8]	Pause and Operation Interruption (*STP, RES, PEND, MOVE)	113
3.2.5	Direct Position Specification (Solenoid Valve Mode 1) = Operation of PIO Pattern 4	115
[1]	Positioning [Basic] (ST0 to ST6, PE0 to PE6, PEND)	115
[2]	Pitch Feeding (Relative Movement = Incremental Feed).....	117
[3]	Pressing Operation	119
[4]	Tension Operation	123
[5]	Multi-step Pressing.....	125
[6]	Pause and Operation Interruption (ST*, *STP, RES, PE*, PEND).....	126
3.2.6	Direct Position Specification (Solenoid Valve Mode 2) = Operation of PIO Pattern 5	128
[1]	Home Return (ST0, HEND).....	128
[2]	Features of LS Signals (LS0 to 2)	132
[3]	Positioning [Basic] (ST0 to ST2, LS0 to LS2)	133
[4]	Speed Change During the Movement.....	135
[5]	Pause and Operation Interruption (ST*, *STP, RES, LS*, PEND)	137
3.3	Pulse Train Control Mode (for Pulse Train Type)	138
3.3.1	I/O Signal Controls.....	139

POWER CON PCON-CB

3.3.2	Operation Ready and Auxiliary Signals	139
[1]	System Ready (PWR)	139
[2]	Emergency Stop Status (*EMGS)	139
[3]	Operation Mode (RMOD, RMDS)	140
[4]	Compulsory Stop (CSTP).....	141
[5]	Servo ON (SON, SV)	141
[6]	Home Return (HOME, HEND)	142
[7]	Datum Position Move (RSTR, REND).....	145
[8]	Zone (ZONE1, ZONE2).....	146
[9]	Alarm, Alarm Reset (*ALM, RES).....	147
[10]	Binary Output of Alarm Data Output (*ALM, ALM1 to 8).....	147
[11]	Brake Forcible Release (BKRL).....	148
3.3.3	Pulse Train Input Operation	149
[1]	Command Pulse Input (PP•/PP, NP•/NP)	149
[2]	Position Complete (INP).....	150
[3]	Torque Limit Select (TL, TLR)	151
[4]	Deviation Counter Clear (DCLR).....	151
3.3.4	Settings of Basic Parameters Required for Operation	152
[1]	Electronic Gear Setting	152
[2]	Format Settings of Command Pulse Train	154
[3]	Pulse Train Datum Position (Parameter No. 167).....	154
3.3.5	Parameter Settings Required for Advanced Operations	155
[1]	Position Command Primary Filter Time Constant.....	155
[2]	Torque Limit.....	155
[3]	Clearing Deviation During Servo OFF or Alarm Stop.....	155
[4]	Deviation Error Monitor During Torque Limiting	156
[5]	Deviation Counter Clear Input.....	156
[6]	Torque Limit Command Input.....	156
[7]	Pulse Count Direction	156
[8]	Compulsory Stop Input.....	156
[9]	Command Output Complete Judgement Time in Non-Positioner Mode.....	157
Chapter 4	Field Network	159
[1]	PCON-CB/CFB Type.....	159
Chapter 5	Other Features	165
5.1	Collision Detection Feature	165
5.1.1	Collision Detection Judgement.....	165
5.1.2	Settings.....	166
5.1.3	Adjustment.....	166
5.2	Power-saving Function.....	167
5.2.1	Automatic Servo-off and Full Servo Functions	167
5.2.2	Automatic Current Reduction Feature	170
5.3	Actuator Information Management Function	171
5.3.1	Actuators with information management function supported	172
5.3.2	Actuator information management function.....	173
5.3.3	Parameters for actuator information management function setting	176
Chapter 6	Absolute Reset and Absolute Battery.....	177
6.1	Absolute Reset	177
[1]	Absolute Reset Procedure from Teaching Tool.....	177
[2]	Absolute Reset Using PIO	180
6.2	Absolute Battery (for Simple Absolute Type).....	182
[1]	For the Type to Attach Battery to Controller Side.....	182
[2]	When Using Absolute Battery Unit.....	182
6.2.1	Absolute Encoder Backup Specifications	182
6.2.2	Absolute Battery Charge.....	182
6.2.3	Replacement of Absolute Battery	184
[1]	For the Type to Attach Battery to Controller Side.....	184
[2]	When Using Absolute Battery Unit.....	185

POWER CON PCON-CB

Chapter 7	Parameter	187
7.1	Parameter List	188
7.2	Detail Explanation of Parameters	192
7.3	Servo Adjustment	223
Chapter 8	Troubleshooting	225
8.1	Action to Be Taken upon Occurrence of Problem	225
8.2	Fault Diagnosis	226
8.2.1	Impossible Operation of Controller	226
8.2.2	Positioning and Speed of Poor Precision (Incorrect Operation)	230
8.2.3	Generation of Noise and/or Vibration	232
8.2.4	Impossible Communication	233
8.3	Alarm Level	234
8.4	Alarm List	235
Chapter 9	Appendix	247
9.1	Way to Set Multiple Controllers with 1 Teaching Tool	247
9.1.1	Connecting Example	247
9.1.2	Detailed Connection Diagram of Communication Lines	248
9.1.3	Axis No. Setting	248
9.1.4	Handling of e-CON Connector (How to Connect)	249
9.1.5	SIO Converter	250
9.1.6	Communications Cable	252
9.1.7	External Dimension	252
9.2	Conformity to Safety Category	253
[1]	System Configuration	253
[2]	Wiring and Setting of Safety Circuit	254
[3]	Examples of Safety Circuits	256
[4]	TP Adapter and Accessories	262
9.3	When Connecting Power Supply with + Grounding	264
9.4	Maintenance	265
9.4.1	Consumed Parts	265
9.4.2	Maintenance Information	265
9.4.3	Replacement of Fan (PCON-CFB)	266
9.5	Example of Basic Positioning Sequence (PIO pattern 0 to 3)	267
9.5.1	I/O Assignment	267
9.5.2	Ladder Sequence	268
[1]	Servo ON (Emergency Stop) Circuit	268
[2]	Operation and Stop Circuit	268
[3]	Pause Circuit	269
[4]	Reset Circuit	270
[5]	Home Return Circuit	271
[6]	Decode Circuit of Positioning Complete Position No.	272
[7]	Actuator Start Circuit	272
[8]	Position 1 Operation Circuit	273
[9]	Position 2 Operation Circuit	274
[10]	Position 3 Operation Circuit	275
[11]	Commanded Position No. Output Ready Circuit	276
[12]	Commanded Position No. Output Circuit	277
[13]	Start Signal Output Circuit	277
[14]	Other Display Circuits (Zone 1, Position Zone, and Manual Mode)	278
9.6	List of Specifications of Connectable Actuators	279
9.6.1	Specifications for Actuators	279
9.6.2	Correlation Diagrams of Speed and Payload	321
9.6.3	Push Force / Gripping Force and Current Limit Value	375
9.6.4	Rotational speed and Output torque / Allowable inertial moment	386
9.7	List of Actuators That Support Information Management Function	388

POWER CON **PCON-CB**

Chapter 10 Warranty.....	389
10.1 Warranty Period.....	389
10.2 Scope of the Warranty.....	389
10.3 Honoring the Warranty.....	389
10.4 Limited Liability.....	389
10.5 Conditions of Conformance with Applicable Standards/Regulations, Etc., and Applications.....	390
10.6 Other Items Excluded from Warranty.....	390
Change History.....	391

POWER CON PCON-CB

★Starting Procedures★

Step 1 Confirm all the necessary things are prepared (Contact us or our sales agency in case of any missing)

Refer to the section "1.1 Product Check" in this manual for more detail.

★Controller (PCON-CB)



* Check also enclosed parts
[Refer to Section 1.1.1]

★Actuator and Connection Cable

(The cable differs depending on the actuator type. [Refer to Step3])



★CD-ROM (Enclosed in RCM-101-□□)

(The following software is included)
• RC PC software



★DVD Instruction Manual

(includes the following instruction manuals)
[Refer to Instruction Manuals related to this product, which are provided on the 1.1.3 DVD.]



- 1) PCON-CB Instruction Manual (this manual)
- 2) RC PC Software Instruction Manual (ME0155)
- 3) Touch Panel Teaching Pendant Instruction Manual (ME0324/ME0355/ME0376)
- 4) Each Field Network Instruction Manual (ME0254, etc.)
- 5) Instruction Manual of the Actuator



★For Field Network Type:

Field Network Setting File
File (e.g. EDS File)

Download it in IAI homepage
(<http://www.iai-robot.co.jp/>)

Step 2 Check How to Operate

The operation modes and control methods will defer depending on the type you have purchased.

★What is Positioner Operation

Operate the registered position data with PIO signal

No.	Position (mm)	Velocity (mm/s)	Acceleration (G)	Deceleration (G)
1	100.00	100.00	0.30	0.30
2	200.00	200.00	0.30	0.30

Edit Position Table of controller

Enter a data including position, velocity, acceleration or deceleration, etc.



★What is Pulse Train Control

Make operation with command pulse

Enter an electronic gear ratio.

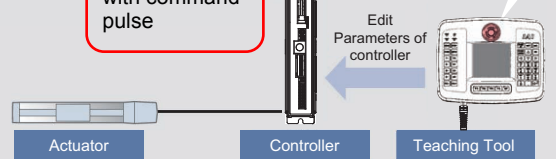

★What is Field Network Control

Field network communication is used instead of connected with and controlled by PIO.
Without using position data, operation can also be made by inputting numbers directly.

Check the operation modes and control methods available on the controller you have purchased.
It can be defined on the controller model code shown on the label in the front face of the controller.



SN: A40969951
PCON-CB-20PWAI-NP-0-0
L=30
ST=8
RCP2-GRSS
Note example

I/O Type

- 1) NP / PN (dedicated for positioner operation)
- 2) PLN / PLP (select from positioner and pulse train)
- 3) For others, (dedicated for field network control)

Type Name

- 1) CB / CGB (select from positioner and pulse train)
- 2) CFB / CGFB (select from positioner and pulse train)

POWER CON PCON-CB

Step 3 Installation "Refer to "1.6 Installation and Storage Environment" and "1.7 Noise Prevention and Installation"

· External Dimensions * Check in 1.3 Appearance as they differ for each type.

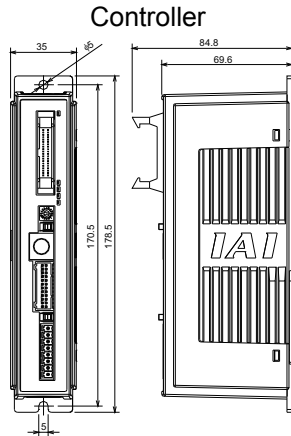

Absolute Battery Unit
(option for Simple Absolute Type)

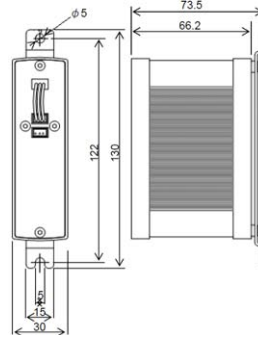

· Noise Elimination Grounding (Frame Ground)

1) Screw fixed type

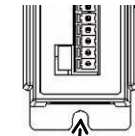

Connect the ground line together to the main unit using the fixing screw.

Copper Wire :
Connect to an ground cable with diameter 1.6mm (2mm²) or more.

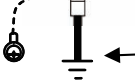

Earth Terminal
(Grounding resistance at 100Ω or less)

2) DIN rail fixed type

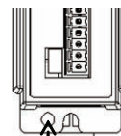

Connect the ground cable using the tapped hole for FG connection on the main unit.

M3 x 5 nickled pan head machine screw
(enclosure dedicated for DIN rail fixed type)

· Heat Radiation and Installation

Keep the ambient temperature of the controller at 40°C or less.

To fix the units in the control box, use the attachment holes on top and bottom of the unit for the screw fixed type, and use the DIN rails for the DIN rail fixed type. Install in the orientation shown in the figure below for heat radiation.

CFB (screw affixed type), detach the fan unit once and use the attachment holes on the top.

[Refer to 9.4.3 Replacement of Fan]

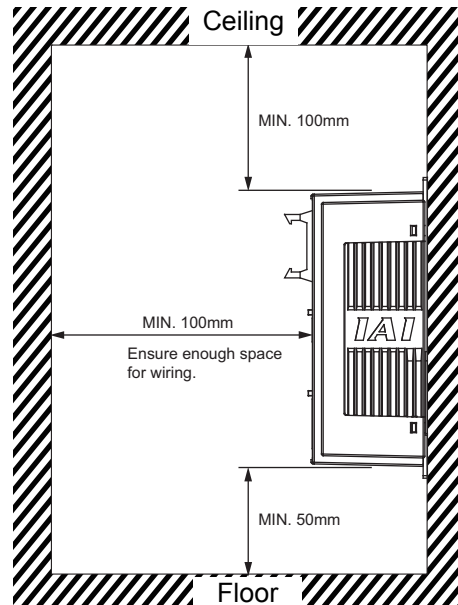
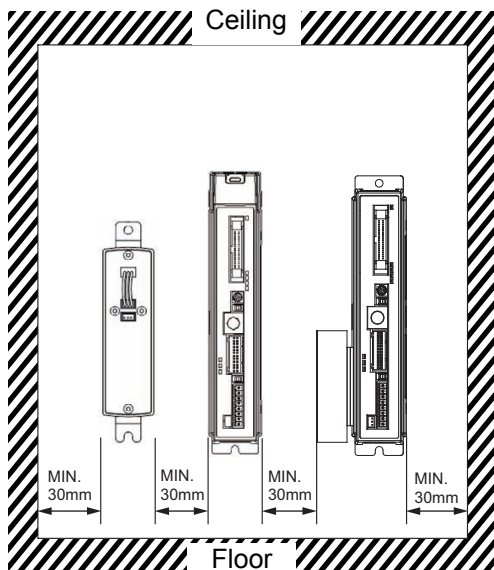

POWER CON PCON-CB

Step 4 Wiring Refer to Chapter 2 "Wiring"

[Positioner Operation]	Refer to Sections 2.1 and 2.3
[Pulse Train Control]	Refer to Sections 2.2 and 2.3
[Field Network Specification]	Refer to Chapter 4

Example for Basic Wiring

The diagram illustrates the basic wiring setup. On the left, a Teaching Pendant and a laptop with PC Software are connected to the controller. The controller is connected to a Host System (PLC, etc.). Two Power Source I/O Control units (24V DC) are connected to the controller. An Emergency Stop Circuit is also connected. The controller is connected to an actuator via a connection cable. Notes indicate that the connection cable differs depending on the actuator and that users should refer to sections 2.1.3 [4] and [2] for more details.

* Refer to 2.1.3 [4] for wiring layout as the signals/features differ for each PIO pattern (selected in Parameter No. 25) in PIO.
 * Perform wiring referring to Chapter 4 Field network for the field network type.

Connection cable differs depending on actuator. [Refer to 2.1.3 [2]]

Step 5 Operate Unit

How you should look in the instruction manuals will differ depending on the operation modes and control methods you choose.
 Establish the settings for your operation needs.

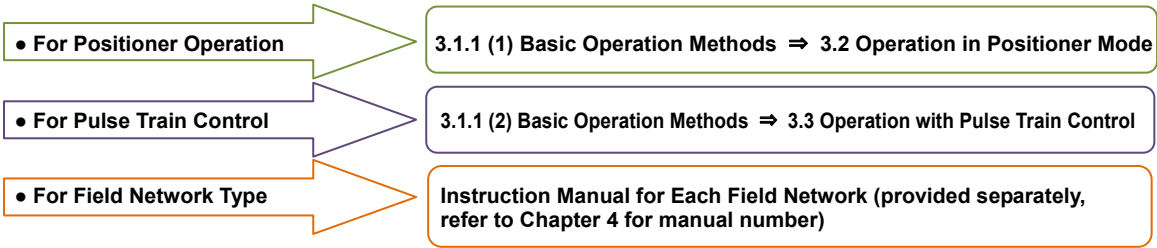

Caution Set it away from the mechanical end or peripherals as much as possible when turning the servo ON. Move it apart when it interferes with peripherals. It may generate an alarm if it hits to the mechanical end or peripherals when the servo is turned on. Also, in case the actuator is installed in vertical orientation, turning ON and OFF the servo at the same spot may cause a slight drop by the self-gravity. Pay attention not to pinch your finger or damage a work piece.

Caution Pay attention not to pinch your finger or damage a work piece by dropping the actuator with self-gravity when it is released compulsorily with the brake release switch placed on the front panel of this controller when it is installed in vertical orientation.

Caution This controller is equipped with a safety velocity function to make the operation in low speed compulsorily. It is recommended to have this function activated in the first operation.

Safety Guide

“Safety Guide” has been written to use the machine safely and so prevent personal injury or property damage beforehand. Make sure to read it before the operation of this product.

Safety Precautions for Our Products

The common safety precautions for the use of any of our robots in each operation.

No.	Operation Description	Description
1	Model Selection	<ul style="list-style-type: none"> ● This product has not been planned and designed for the application where high level of safety is required, so the guarantee of the protection of human life is impossible. Accordingly, do not use it in any of the following applications. <ol style="list-style-type: none"> 1) Medical equipment used to maintain, control or otherwise affect human life or physical health. 2) Mechanisms and machinery designed for the purpose of moving or transporting people (For vehicle, railway facility or air navigation facility) 3) Important safety parts of machinery (Safety device, etc.) ● Do not use the product outside the specifications. Failure to do so may considerably shorten the life of the product. ● Do not use it in any of the following environments. <ol style="list-style-type: none"> 1) Location where there is any inflammable gas, inflammable object or explosive 2) Place with potential exposure to radiation 3) Location with the ambient temperature or relative humidity exceeding the specification range 4) Location where radiant heat is added from direct sunlight or other large heat source 5) Location where condensation occurs due to abrupt temperature changes 6) Location where there is any corrosive gas (sulfuric acid or hydrochloric acid) 7) Location exposed to significant amount of dust, salt or iron powder 8) Location subject to direct vibration or impact ● For an actuator used in vertical orientation, select a model which is equipped with a brake. If selecting a model with no brake, the moving part may drop when the power is turned OFF and may cause an accident such as an injury or damage on the work piece.

No.	Operation Description	Description
2	Transportation	<ul style="list-style-type: none"> ● When carrying a heavy object, do the work with two or more persons or utilize equipment such as crane. ● When the work is carried out with 2 or more persons, make it clear who is to be the leader and who to be the follower(s) and communicate well with each other to ensure the safety of the workers. ● When in transportation, consider well about the positions to hold, weight and weight balance and pay special attention to the carried object so it would not get hit or dropped. ● Transport it using an appropriate transportation measure. The actuators available for transportation with a crane have eyebolts attached or there are tapped holes to attach bolts. Follow the instructions in the instruction manual for each model. ● Do not step or sit on the package. ● Do not put any heavy thing that can deform the package, on it. ● When using a crane capable of 1t or more of weight, have an operator who has qualifications for crane operation and sling work. ● When using a crane or equivalent equipments, make sure not to hang a load that weighs more than the equipment's capability limit. ● Use a hook that is suitable for the load. Consider the safety factor of the hook in such factors as shear strength. ● Do not get on the load that is hung on a crane. ● Do not leave a load hung up with a crane. ● Do not stand under the load that is hung up with a crane.
3	Storage and Preservation	<ul style="list-style-type: none"> ● The storage and preservation environment conforms to the installation environment. However, especially give consideration to the prevention of condensation. ● Store the products with a consideration not to fall them over or drop due to an act of God such as earthquake.
4	Installation and Start	<p>(1) Installation of Robot Main Body and Controller, etc.</p> <ul style="list-style-type: none"> ● Make sure to securely hold and fix the product (including the work part). A fall, drop or abnormal motion of the product may cause a damage or injury. Also, be equipped for a fall-over or drop due to an act of God such as earthquake. ● Do not get on or put anything on the product. Failure to do so may cause an accidental fall, injury or damage to the product due to a drop of anything, malfunction of the product, performance degradation, or shortening of its life. ● When using the product in any of the places specified below, provide a sufficient shield. <ol style="list-style-type: none"> 1) Location where electric noise is generated 2) Location where high electrical or magnetic field is present 3) Location with the mains or power lines passing nearby 4) Location where the product may come in contact with water, oil or chemical droplets

No.	Operation Description	Description
4	Installation and Start	<p>(2) Cable Wiring</p> <ul style="list-style-type: none"> ● Use our company's genuine cables for connecting between the actuator and controller, and for the teaching tool. ● Do not scratch on the cable. Do not bend it forcibly. Do not pull it. Do not coil it around. Do not insert it. Do not put any heavy thing on it. Failure to do so may cause a fire, electric shock or malfunction due to leakage or continuity error. ● Perform the wiring for the product, after turning OFF the power to the unit, so that there is no wiring error. ● When the direct current power (+24V) is connected, take the great care of the directions of positive and negative poles. If the connection direction is not correct, it might cause a fire, product breakdown or malfunction. ● Connect the cable connector securely so that there is no disconnection or looseness. Failure to do so may cause a fire, electric shock or malfunction of the product. ● Never cut and/or reconnect the cables supplied with the product for the purpose of extending or shortening the cable length. Failure to do so may cause the product to malfunction or cause fire. <p>(3) Grounding</p> <ul style="list-style-type: none"> ● The grounding operation should be performed to prevent an electric shock or electrostatic charge, enhance the noise-resistance ability and control the unnecessary electromagnetic radiation. ● For the ground terminal on the AC power cable of the controller and the grounding plate in the control panel, make sure to use a twisted pair cable with wire thickness 0.5mm² (AWG20 or equivalent) or more for grounding work. For security grounding, it is necessary to select an appropriate wire thickness suitable for the load. Perform wiring that satisfies the specifications (electrical equipment technical standards). ● Perform Class D Grounding (former Class 3 Grounding with ground resistance 100Ω or below).

No.	Operation Description	Description
4	Installation and Start	<p>(4) Safety Measures</p> <ul style="list-style-type: none"> ● When the work is carried out with 2 or more persons, make it clear who is to be the leader and who to be the follower(s) and communicate well with each other to ensure the safety of the workers. ● When the product is under operation or in the ready mode, take the safety measures (such as the installation of safety and protection fence) so that nobody can enter the area within the robot's movable range. When the robot under operation is touched, it may result in death or serious injury. ● Make sure to install the emergency stop circuit so that the unit can be stopped immediately in an emergency during the unit operation. ● Take the safety measure not to start up the unit only with the power turning ON. Failure to do so may start up the machine suddenly and cause an injury or damage to the product. ● Take the safety measure not to start up the machine only with the emergency stop cancellation or recovery after the power failure. Failure to do so may result in an electric shock or injury due to unexpected power input. ● When the installation or adjustment operation is to be performed, give clear warnings such as "Under Operation; Do not turn ON the power!" etc. Sudden power input may cause an electric shock or injury. ● Take the measure so that the work part is not dropped in power failure or emergency stop. ● Wear protection gloves, goggle or safety shoes, as necessary, to secure safety. ● Do not insert a finger or object in the openings in the product. Failure to do so may cause an injury, electric shock, damage to the product or fire. ● When releasing the brake on a vertically oriented actuator, exercise precaution not to pinch your hand or damage the work parts with the actuator dropped by gravity.
5	Teaching	<ul style="list-style-type: none"> ● When the work is carried out with 2 or more persons, make it clear who is to be the leader and who to be the follower(s) and communicate well with each other to ensure the safety of the workers. ● Perform the teaching operation from outside the safety protection fence, if possible. In the case that the operation is to be performed unavoidably inside the safety protection fence, prepare the "Stipulations for the Operation" and make sure that all the workers acknowledge and understand them well. ● When the operation is to be performed inside the safety protection fence, the worker should have an emergency stop switch at hand with him so that the unit can be stopped any time in an emergency. ● When the operation is to be performed inside the safety protection fence, in addition to the workers, arrange a watchman so that the machine can be stopped any time in an emergency. Also, keep watch on the operation so that any third person can not operate the switches carelessly. ● Place a sign "Under Operation" at the position easy to see. ● When releasing the brake on a vertically oriented actuator, exercise precaution not to pinch your hand or damage the work parts with the actuator dropped by gravity. <p>* Safety protection Fence : In the case that there is no safety protection fence, the movable range should be indicated.</p>





POWER CON PCON-CB

No.	Operation Description	Description
6	Trial Operation	<ul style="list-style-type: none"> ● When the work is carried out with 2 or more persons, make it clear who is to be the leader and who to be the follower(s) and communicate well with each other to ensure the safety of the workers. ● After the teaching or programming operation, perform the check operation one step by one step and then shift to the automatic operation. ● When the check operation is to be performed inside the safety protection fence, perform the check operation using the previously specified work procedure like the teaching operation. ● Make sure to perform the programmed operation check at the safety speed. Failure to do so may result in an accident due to unexpected motion caused by a program error, etc. ● Do not touch the terminal block or any of the various setting switches in the power ON mode. Failure to do so may result in an electric shock or malfunction.
7	Automatic Operation	<ul style="list-style-type: none"> ● Check before starting the automatic operation or rebooting after operation stop that there is nobody in the safety protection fence. ● Before starting automatic operation, make sure that all peripheral equipment is in an automatic-operation-ready state and there is no alarm indication. ● Make sure to operate automatic operation start from outside of the safety protection fence. ● In the case that there is any abnormal heating, smoke, offensive smell, or abnormal noise in the product, immediately stop the machine and turn OFF the power switch. Failure to do so may result in a fire or damage to the product. ● When a power failure occurs, turn OFF the power switch. Failure to do so may cause an injury or damage to the product, due to a sudden motion of the product in the recovery operation from the power failure.

No.	Operation Description	Description
8	Maintenance and Inspection	<ul style="list-style-type: none"> ● When the work is carried out with 2 or more persons, make it clear who is to be the leader and who to be the follower(s) and communicate well with each other to ensure the safety of the workers. ● Perform the work out of the safety protection fence, if possible. In the case that the operation is to be performed unavoidably inside the safety protection fence, prepare the “Stipulations for the Operation” and make sure that all the workers acknowledge and understand them well. ● When the work is to be performed inside the safety protection fence, basically turn OFF the power switch. ● When the operation is to be performed inside the safety protection fence, the worker should have an emergency stop switch at hand with him so that the unit can be stopped any time in an emergency. ● When the operation is to be performed inside the safety protection fence, in addition to the workers, arrange a watchman so that the machine can be stopped any time in an emergency. Also, keep watch on the operation so that any third person can not operate the switches carelessly. ● Place a sign “Under Operation” at the position easy to see. ● For the grease for the guide or ball screw, use appropriate grease according to the Instruction Manual for each model. ● Do not perform the dielectric strength test. Failure to do so may result in a damage to the product. ● When releasing the brake on a vertically oriented actuator, exercise precaution not to pinch your hand or damage the work parts with the actuator dropped by gravity. ● The slider or rod may get misaligned OFF the stop position if the servo is turned OFF. Be careful not to get injured or damaged due to an unnecessary operation. ● Pay attention not to lose the cover or untightened screws, and make sure to put the product back to the original condition after maintenance and inspection works. Use in incomplete condition may cause damage to the product or an injury. <p>* Safety protection Fence : In the case that there is no safety protection fence, the movable range should be indicated.</p>
9	Modification and Dismantle	<ul style="list-style-type: none"> ● Do not modify, disassemble, assemble or use of maintenance parts not specified based at your own discretion.
10	Disposal	<ul style="list-style-type: none"> ● When the product becomes no longer usable or necessary, dispose of it properly as an industrial waste. ● When removing the actuator for disposal, pay attention to drop of components when detaching screws. ● Do not put the product in a fire when disposing of it. The product may burst or generate toxic gases.
11	Other	<ul style="list-style-type: none"> ● Do not come close to the product or the harnesses if you are a person who requires a support of medical devices such as a pacemaker. Doing so may affect the performance of your medical device. ● See Overseas Specifications Compliance Manual to check whether complies if necessary. ● For the handling of actuators and controllers, follow the dedicated instruction manual of each unit to ensure the safety.

Alert Indication

The safety precautions are divided into “Danger”, “Warning”, “Caution” and “Notice” according to the warning level, as follows, and described in the Instruction Manual for each model.

Level	Degree of Danger and Damage	Symbol
Danger	This indicates an imminently hazardous situation which, if the product is not handled correctly, will result in death or serious injury.	 Danger
Warning	This indicates a potentially hazardous situation which, if the product is not handled correctly, could result in death or serious injury.	 Warning
Caution	This indicates a potentially hazardous situation which, if the product is not handled correctly, may result in minor injury or property damage.	 Caution
Notice	This indicates lower possibility for the injury, but should be kept to use this product properly.	 Notice

■ Precautions in Operation ■

1. Make sure to follow the usage condition, environment and specification range of the product.
In case it is not secured, it may cause a drop in performance or malfunction of the product.
2. Use the following teaching tools.
Use the PC software and the teaching pendant stated in the next clause as applicable for this controller.
[Refer to 1.1.2 Teaching Tool.]
3. Backup the data to secure for breakdown.
A non-volatile memory is used as the backup memory for this controller. All the registered position data and parameters are written into this memory and backed-up at the same time. Therefore, you will not usually lose the data even if the power is shut down. However, make sure to save the latest data so a quick recovery action can be taken in case when the controller is broken and needs to be replaced with another one.

How to Save Data

- (1) Save the data to non-volatile memory with using the PC software
- (2) Hard-copy the information of position tables and parameters on paper

4. Set the operation patterns.
This controller processes 8 types of control logics (including 6 types of PIO patterns and 2 types pulse train control) to meet various ways of usage, and changes the role of each PIO signal following the selected control logic.
 - 1) In PIO specification, there are 6 types of PIO patterns available to choose from.
 - 2) For Pulse Train specification, not only the 2 types pulse train control mode, but also 6 types of PIO patterns are available.The setup can be performed by using the parameter No.25 "PIO pattern selection".
[Refer to Chapter 3 Operation and Chapter 7 Parameter.]
The PIO pattern is set to "0" (Standard Type) when the unit is delivered. Set the operation pattern setting to the logic that suits to your use after the power is turned on.

 **Warning** : Please note it is very risky when the control sequence and PIO pattern setting do not match to each other. It may not only cause the normal operation disabled, but also may cause an unexpected operation.

5. Clock Setting in Calendar Function
There may be a case that "Alarm Code 069 Real Time Clock Vibration Stop Detect" is issued at the first time to turn the power on after the product is delivered. In the case this happens, set the current time with a teaching tool.
If the battery is fully charged, the clock data is retained for approximately 10 days after the power is turned off. Even though the time setting is conducted before the product is shipped out, the battery is not fully charged. Therefore, there may be a case that the clock data is lost even with fewer days than described above passed since the product is shipped out.
6. In pulse train control mode, actuator operation is unavailable through serial communication.
In the pulse train control mode, the actuator operation is unavailable through serial communication. However, it is possible to monitor the current status.

7. Attempt not to exceed the actuator specifications in the pulse train control mode.

In Pulse Train Control Mode, the operation is performed corresponding to the input pulse.

- Input Pulse Value → Moving distance
- Input pulse frequency → Velocity
- Change in Input Pulse Frequency → Velocity change and acceleration/deceleration

Do not use the actuator above the specifications (for stroke, maximum velocity, maximum acceleration/deceleration) for the commands of the movement amount, velocity and acceleration/deceleration from the host controller (PLC). Doing so may cause an error or malfunction.

The pressing operation velocity should be set to the rated pressing velocity when it is to conduct the pressing operation. Pressing with velocity not at the rated pressing velocity could end up with pressing force different from that shown in "Push Force / Gripping Force and Current Limit Value" in Appendix in Chapter 9. Also, operation in velocity higher than the rated pressing velocity could cause an error or malfunction.

Refer to "9.6 List of Specifications of Connectable Actuators" or model code for the specifications and rated pressing velocity for each actuator.

8. Actuator would not operate without servo-on and pause signals.

(1) Servo ON Signal (SON)

Servo ON signal (SON) is selectable from "Enable" or "Disable" by using a parameter. It is settable by parameter No.21 "selection of servo-on signal disable".

[Refer to Chapter 7 Parameter.]

If it is set to "Enable", the actuator would not operate unless turning this signal on.

If parameter No.21 is set to "1", SON requirement is disabled.

If it is set to "Disable", the servo becomes on and the actuator operation becomes enabled as soon as the power supply to the controller is turned on and the emergency stop signal is cancelled.

This parameter is set to "0" (Enable) at delivery. Have the setting that suits the desired control logic.

(2) Pause Signal (*STP)

The input signal of the pause signal (*STP) is always on considering the safety. Therefore, in general, the actuator would not operate if this signal is not on.

It is available to make this signal to "Disable", if this signal is undesirable.

It is settable by parameter No.15 "Pause input disable".

[Refer to Chapter 7 Parameter.]

If parameter No.15 is set to "1" (Disable), the actuator can operate even if this signal is not on.

This parameter is set to "0" (Enable) at delivery.

9. Note that there are some frictions and/or torsions in through-hole of rotary actuator when it is used.

When using rotary actuator with a through hole in the center of the revolution and using the hole to put cables through, have a treatment to prevent wear from rubbing or wire break due to the cables getting twisted.

Take particular note on actuators of 360-degree specification because they can be rotated infinitely in a single direction.

10. Limitations on operation of rotary actuator in index mode

Rotary actuators of 360-degree specification can select the normal mode for finite rotations or the index mode enabling multi-rotation control by using parameter No.79 "Rotational axis mode selection". [Refer to Chapter 7 Parameter.]

The following limitations are applied to the index mode:

- 1) RCP6-RTFML cannot be used in Index Mode.
- 2) Index Mode cannot be used in Pulse Train Control Mode and MECHATROLINK-III Connection Type.
- 3) In the JOG or Inching Operation using a teaching tool such as PC software or using PIO signal, the range of 1 time of command is 360° at maximum for JOG while 1° at maximum for Inching.
- 4) Pressing is unavailable. The pressing torque can only be set to 0.
- 5) Do not issue positioning command around 0° repeatedly during movement near 0°. Failure to follow this may cause the actuator to rotate in the direction reverse to the specified rotation direction or operate indefinitely.
- 6) Software stroke limit is invalid in the index mode.

11. Transference of PIO Signal between Controllers

Please note the following when conducting transference of PIO signal between controllers.

To certainly transfer the signal between controllers with different scan time, it is necessary to have longer scan time than the one longer than the other controller. To ensure to end the process safely, it is recommended to have the timer setting more than twice as long as the longer scan time at least.

● Operation Image

PLC

(e.g. scan time is 20ms)

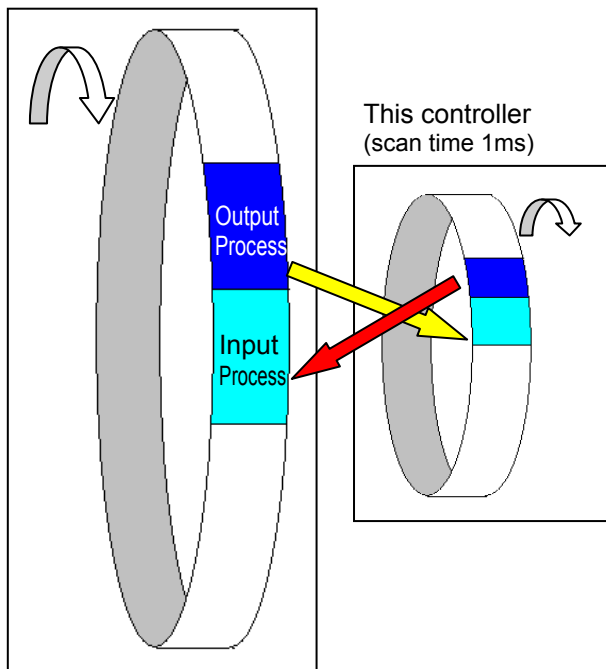

As shown in the diagram, the input and output timings of two devices that have different scan time do not match, of course, when transferring a signal.

There is no guarantee that PLC would read the signal as soon as this controller signal turns on. In such a case, make the setting to read the signal after a certain time that is longer than the longer scan time to ensure the reading process to succeed on the PLC side.

It is the same in the case this controller side reads the signal.

In such a case, it is recommended to ensure 2 to 4 times of the scan time for the timer setting margin.

It is risky to have the setting below the scan time since the timer is also processed in the scan process.

In the diagram, PLC can only read the input once in 20ms even though this controller output once in 1ms.

Because PLC only conducts output process once in 20ms, this controller identifies the same output status for that while.

Also, if one tries to read the signal that is being re-written by the other, the signal may be read wrongly. Make sure to read the signal after the rewriting is complete. (It is recommended to have more than 2 scan periods to wait.) Make sure not to have the output side to change the output until the other side completes the reading. Also, a setting is made on the input area not to receive the signal less than a certain time to prevent a wrong reading of noise. This duration also needs to be considered.

12. PLC Timer Setting

Do not have the PLC timer setting to be done with the minimum setting.

Setting to “1” for 100ms timer turns ON at the timing from 0 to 100ms while 10ms timer from 0 to 10ms for some PLC.

Therefore, the same process as when the timer is not set is held and may cause a failure such as the actuator cannot get positioned to the indicated position number in Positioner Mode.

Set “2” as the minimum value for the setting of 10ms timer and when setting to 100ms, use 10ms timer and set to “10”.

13. Regarding Battery-less Absolute Type Actuator

- 1) For the first time to turn the servo ON after turning on the power, it will have slight position adjustment due to the characteristics of the stepping motor. The maximum movement amount at position adjustment operation is the distance of $0.025 \times \text{lead length [mm]}$. Also, the current position displayed on the teaching tool before turning the servo on is the coordinates before adjustment operation.
- 2) After the first time the servo is tuned ON after the power has been supplied, the home-return complete signal [HEND] and the limit switch output signal (LS) are output.
- 3) When the first servo ON is conducted out of the soft limit range, an error would not be output. Soft limit monitoring starts after it is moved into the range.
- 4) Make sure to have a home-return operation (absolute reset) after detaching the motor unit from the actuator for motor replacement purpose and so on.
- 5) There is the manufacturing number of the connectable actuator printed on the front panel of the controller. Make sure to connect without mistake. The absolute error will occur if the connection is wrong.
- 6) When using in Pulse Train Control Mode, and set Parameter No. 25 to 7.

14. Startup Time of Controller

Have 1 second or more as an initializing time at the power on (startup).

■ International Standards Compliances ■

PCON-CA comply with the following international standards:

Refer to Overseas Standard Compliance Manual (ME0287) for more detailed information.

RoHS Directive	CE Marking	UL
○	○ ^(Note 1)	○

Note 1 Those in type for CC-Link IE Field connection and MECHATROLINK-I/II connection are not complied.

POWER CON PCON-CB

■ Name for Each Parts and Their Functions ■

CB/CGB Type

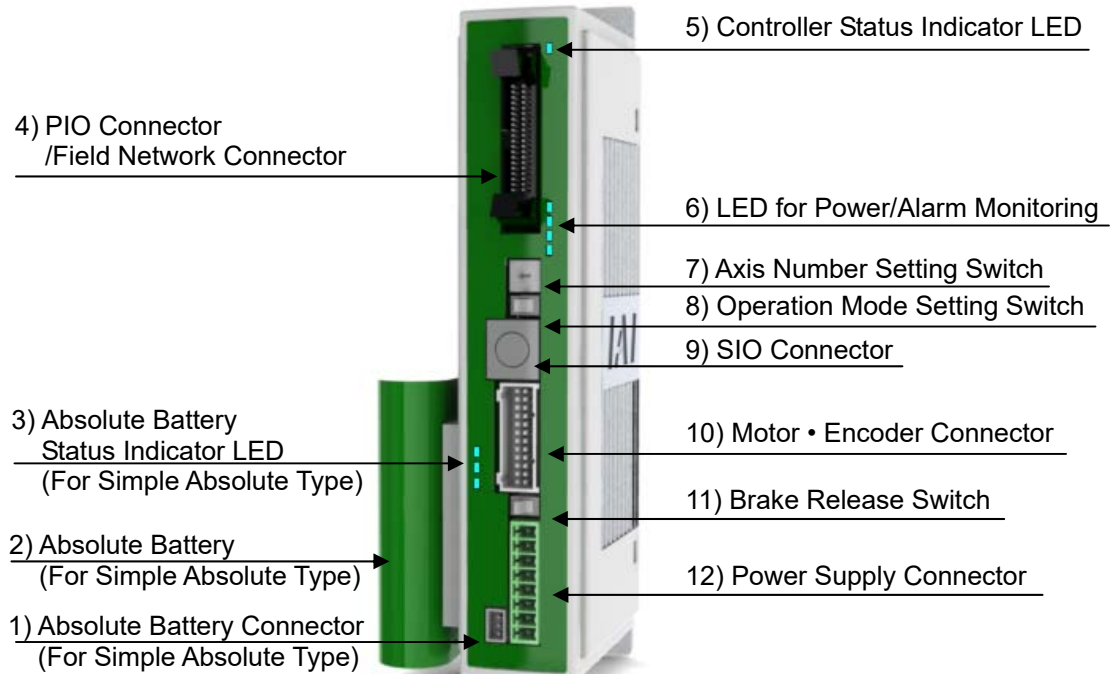

CFB/CGFB Type

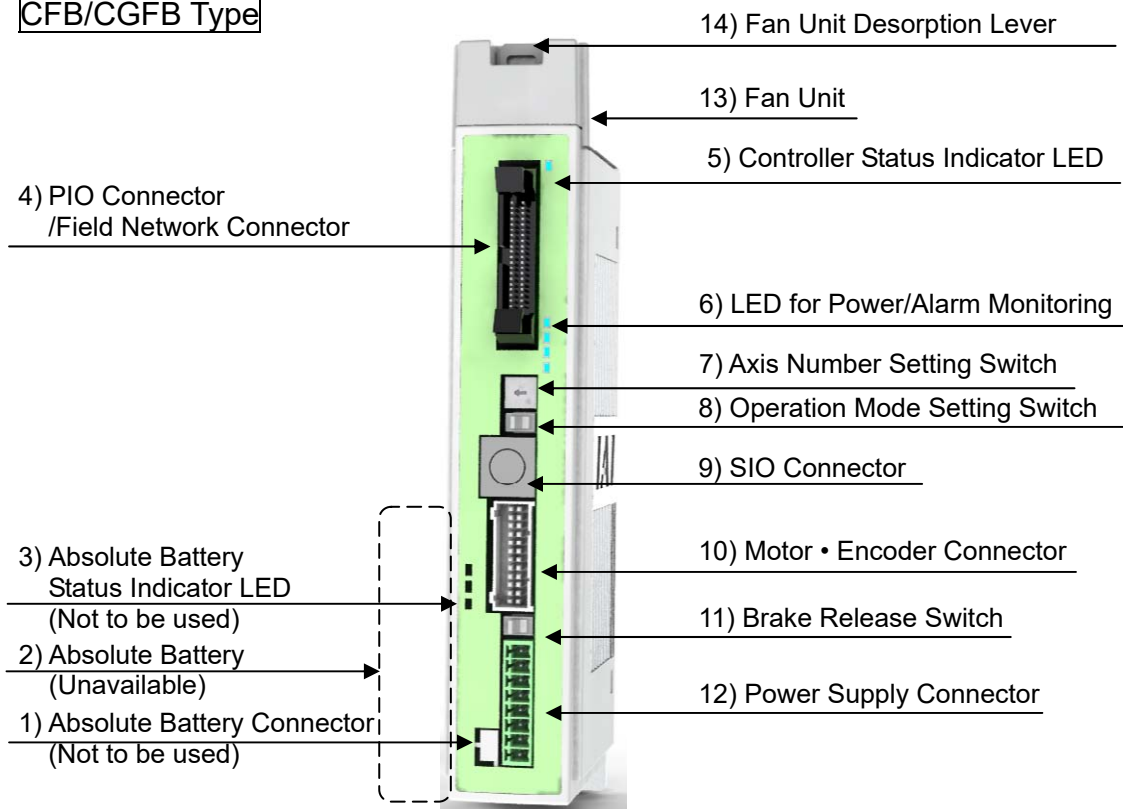

⚠ Caution : In this manual, each type of CB/CGB/CFB/CGFB is stated as CB or CFB.

POWER CON PCON-CB

- 1) Absolute Battery Connector [Refer to Chapter 6]
It is the connector to plug in the enclosed battery if applicable for Simple Absolute Type (option).
- 2) Absolute Battery [Refer to Chapter 6]
It is enclosed if applicable for Simple Absolute Type (option).
Use unit by affixing it on the side of PCON body with fabric hook-and-loop fastener or store it Absolute Battery Unit (option).
- 3) Absolute Battery Status Indicator LED [Refer to Chapter 6]
It is equipped if applicable for Simple Absolute Type (option).
It displays the status such as battery charge condition and error generation.
○ : Illuminating × : OFF

LED			Operation status
RDY(GN)/ ALM(RD)	1 (GN/RD)	0 (GN/OR/RD)	Description
×	×	×	Control Power OFF
○ (GN)	○ (GN)	○ (Either color)	Absolute Reset Complete
○ (GN)	○ (RD)	○ (Either color)	Absolute Reset Incomplete
○ (RD)	○ (RD)	○ (Either color)	Error occurred.
○ (Either color)	○ (Either color)	○ (GN)	Battery Fully Charged
○ (Either color)	○ (Either color)	○ (OR)	Battery Charging Operation
○ (Either color)	○ (Either color)	○ (RD)	Battery Disconnected

- 4) PIO Connector/ Field Network Connector
PIO Type is equipped with the input and output signal connectors for control and Field Network Type with connectors for each field network connection.
[Refer to 2.1.2 PIO Pattern Selection and PIO Signal or 2.2.2 I/O Signals in Pulse Train Control Mode]
[For the details of the field network, refer to Chapter 4 and the instruction manual for each field network.]
- 5) Controller Status Indicator LED
Following show the controller operation status:
○ : Illuminating × : OFF ☆ : Flashing

LED		Operation status
SV (GN)	ALM (RD)	
×	×	Control Power OFF Servo OFF
×	○	Alarm (Operation Cancellation Level or more) Motor Driving Power Supply OFF In the Emergency Stop
○	×	Servo ON
☆	×	During Automatic servo-off ^(Note 1)
○ (OR)		During initialization after power is supplied

Note 1 Signal during automatic servo-off : [Refer to 5.2]

POWER CON PCON-CB

6) LED for Current/Alarm Monitoring

In the ordinary use, it shows the command current percentage and shows the alarm code during an alarm being generated.

LED	Operation status																																							
STS3 (GN)	Status Display <ul style="list-style-type: none"> During servo-off: it displays the current command current ratio (proportional to the rated current). 																																							
STS2 (GN)	○ : Illuminating × : OFF <table border="1" style="margin-top: 10px;"> <thead> <tr> <th colspan="4">STATUS</th> <th rowspan="2">Command Current Ratio</th> </tr> <tr> <th>3</th> <th>2</th> <th>1</th> <th>0</th> </tr> </thead> <tbody> <tr> <td>ALM8</td> <td>ALM4</td> <td>ALM2</td> <td>ALM1</td> <td>Simple alarm code</td> </tr> <tr> <td>×</td> <td>×</td> <td>×</td> <td>×</td> <td>0.00% to 6.24%</td> </tr> <tr> <td>×</td> <td>×</td> <td>×</td> <td>○</td> <td>6.25% to 24.99%</td> </tr> <tr> <td>×</td> <td>×</td> <td>○</td> <td>○</td> <td>25.00% to 49.99%</td> </tr> <tr> <td>×</td> <td>○</td> <td>○</td> <td>○</td> <td>50.00% to 74.99%</td> </tr> <tr> <td>○</td> <td>○</td> <td>○</td> <td>○</td> <td>75.00% to 100.00% or more</td> </tr> </tbody> </table>	STATUS				Command Current Ratio	3	2	1	0	ALM8	ALM4	ALM2	ALM1	Simple alarm code	×	×	×	×	0.00% to 6.24%	×	×	×	○	6.25% to 24.99%	×	×	○	○	25.00% to 49.99%	×	○	○	○	50.00% to 74.99%	○	○	○	○	75.00% to 100.00% or more
STATUS				Command Current Ratio																																				
3	2	1	0																																					
ALM8	ALM4	ALM2	ALM1	Simple alarm code																																				
×	×	×	×	0.00% to 6.24%																																				
×	×	×	○	6.25% to 24.99%																																				
×	×	○	○	25.00% to 49.99%																																				
×	○	○	○	50.00% to 74.99%																																				
○	○	○	○	75.00% to 100.00% or more																																				
STS1 (GN)																																								
STS0 (GN)	<ul style="list-style-type: none"> During alarm generation: it displays the simple alarm code. [Refer to 3.2.3 [7] and 3.3.2 [10] Binary Output of Alarm Data Output] 																																							

7) Axis Number Setting Switch

It is the switch to set the axis numbers when having an operation of multiple axes by the serial communication, or when having the gateway operation.

Using the SIO converter allows multiple axes to be controlled on a teaching tool without connection/disconnection of the connection cable connector. The SIO converter can specify up to 16 axes with hexadecimal numbers 0 to F.

The setting of the switch is read at power-on of the controller. Changing the setting after the power-on is invalid.

Point the arrow at a desired number with a flat-head screwdriver

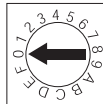

Caution : Note duplicate axis number setting, which causes a communication error (alarm code 30C: no connection axis error) to occur and disables normal communication.

8) Operation Mode Setting Switch (MANU/AUTO)

The switch for interlock.

Setting to switch	Operation status
AUTO	Allows auto operation by PIO signals. The teaching tool can only operate the monitor.
MANU	Allows the teaching tool to operate the controller.

9) SIO Connector (SIO) [Refer to 2.3.5 SIO Connector Connection.]

The SIO connector is used to connect the controller with a teaching tool or a gateway unit through a proper communication cable.

10) Motor • Encoder Connector [Refer to 2.1.3 [2] and 2.2.3 [2] Motor • Encoder Circuit]

It is the connector to connect the actuator motor and encoder cable.

POWER CON PCON-CB

11) Brake Release Switch (BK RLS/NOM)

For the actuator equipped with a brake, the switch is used to release the brake forcibly.

BK RLS ···· Brake forcible release

NOM ······ Normal operation (brake is activated)



Warning : Always set the switch to “NOM” in normal operation.

(Make sure the opportunity to put the switch to RLS side is the minimum and is limited to when startup and adjustment. Make certain to set the switch to NOM side in normal use.)

The brake would not work even with the servo OFF condition if the switch is on the RLS side. In the vertical oriented mount, the work may drop and cause an injury or the work to be damaged.

12) Power Supply Connector [Refer to 2.3.1 Wiring Layout of Power Supply Connector]

It is the connector for the power supply (for controller control power, actuator driving and brake control power) and for the input of emergency status signal.

13) Fan Unit

It is a forced cooling unit dedicated for PCON-CFB Type.

14) Fan Unit Desorption Lever

When fixing to a control box and replacing the fan unit, pull the lever up and the fan unit can be taken out. When fixing, put the unit back on, and when replacing, attach a new unit, and push the lever down to affix the unit.

How to Detach

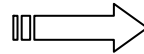
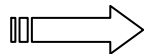

φ5 hole to hold main body

How to Attach



Match the connectors to attach

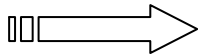

Push in the lever till making a click noise

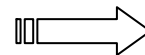

■ Actuator Axes ■

Refer to the pictures below for the actuator axes that can be controlled.
0 defines the home position, and items in () are for the home-reversed type (option).

⚠ Caution : There are some actuators that are not applicable to the origin reversed type.
Check further on the catalog or the Instruction Manual of the actuator.

(1) Rod Type

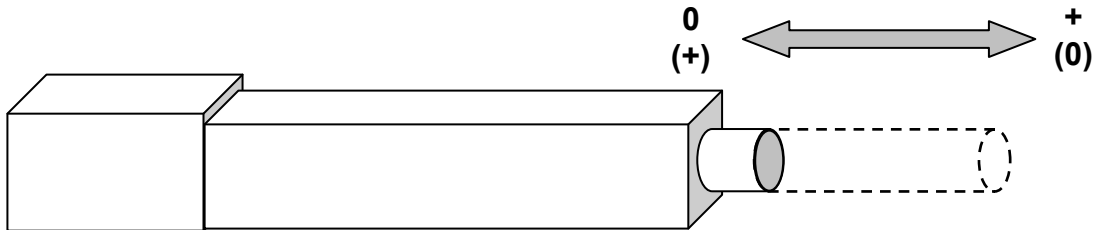

(2) Slider Type

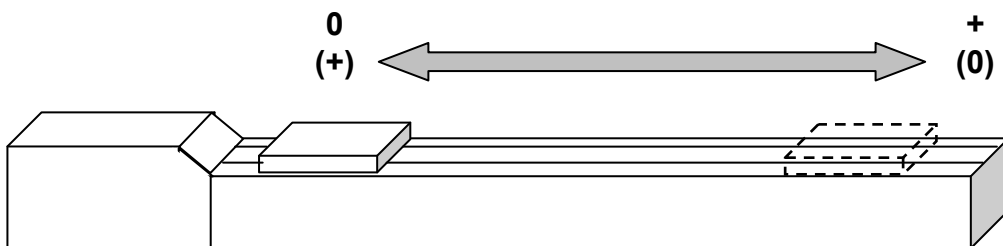

(3) Table Type

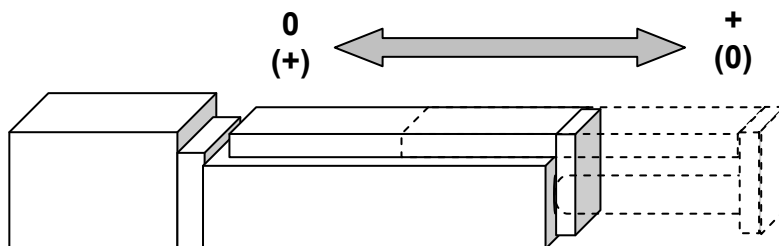

(4) Arm Type

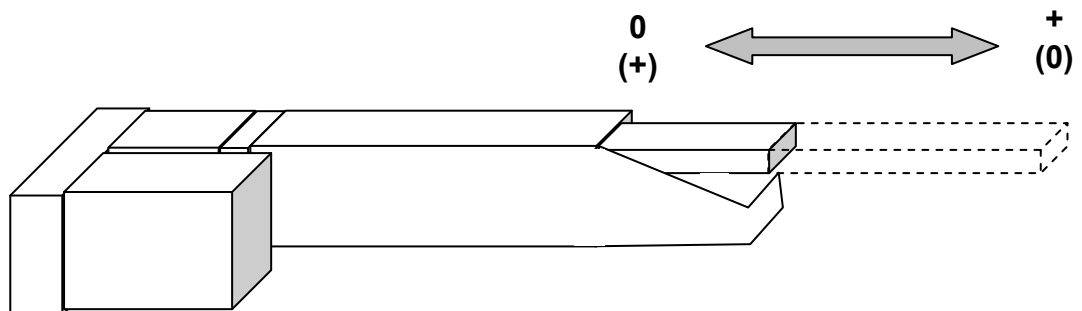

POWER CON PCON-CB

(5) Gripper Type

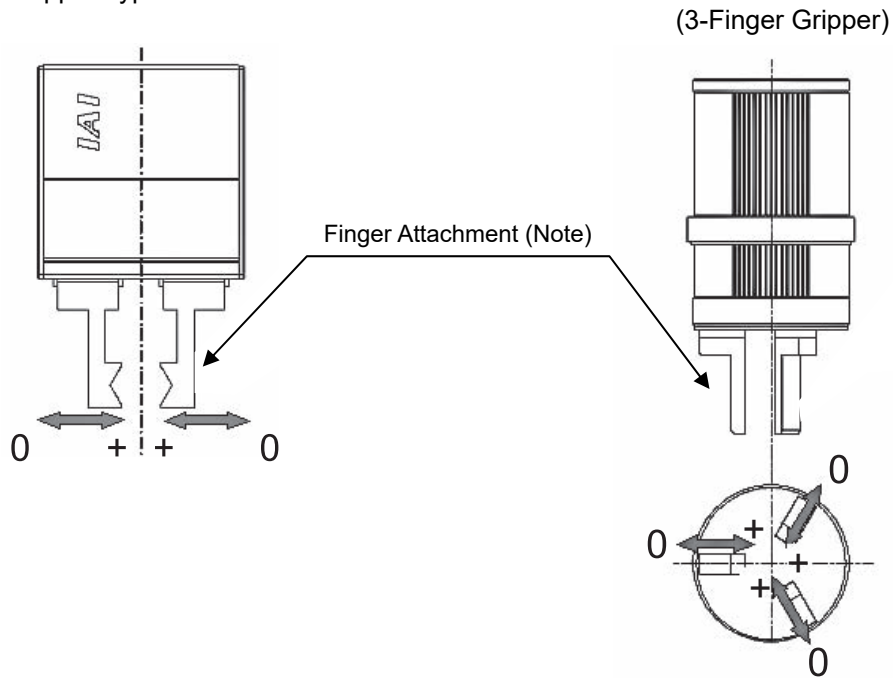

Note Finger attachment is not included in the actuator package. Please prepare separately.

(6) Rotary Type

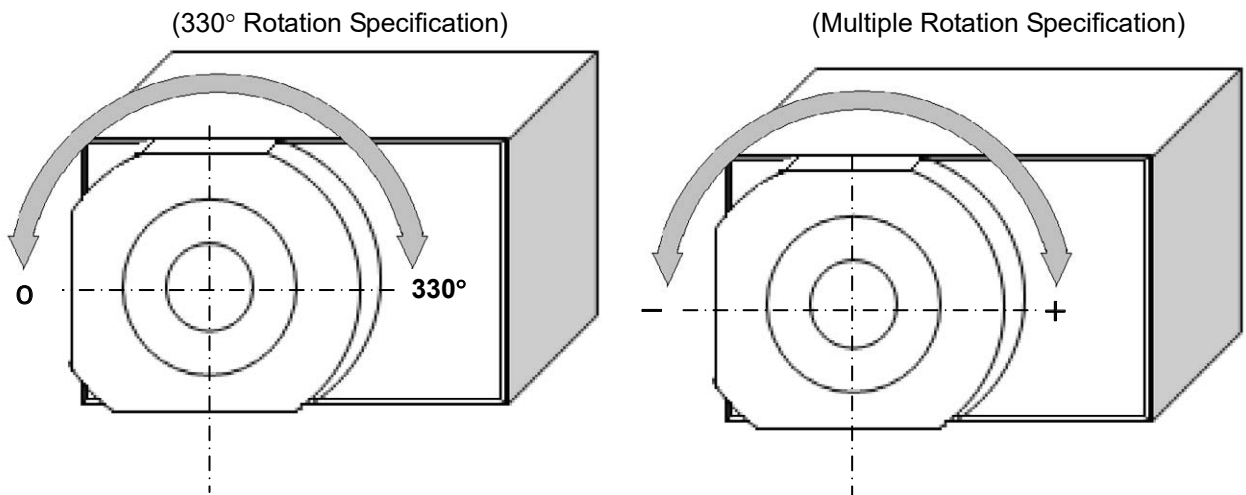

For Multiple Rotation Type with the origin reversed type, the directions of + and - are the other way around.







POWER CON **PCON-CB** --- ---

Chapter 1 Specifications Check

1.1 Product Check

1.1.1 Parts

This product is comprised of the following parts if it is of standard configuration.
If you find any fault in the contained model or any missing parts, contact us or our distributor.

No.	Part Name	Model	Quantity	Remarks
1	Controller	Refer to "How to Read the Model Plate", "How to Read the Model".	1	
Accessories				
2	I/O Flat Cable	CB-PAC-PIO□□□ 	1	□□□ shows the cable length (Example) □□□ : 020 = 2 [m]
3	Power Connector	FMC1.5/8-ST-3.5 (Supplier : Phoenix Contact) 	1	Recommended cable size 1.25 to 0.5mm ² (AWG16 to 20)
4	Absolute Battery (Option)	AB-7 or SEP-ABU* 	1	For Simple Absolute Type
5	Dummy Plug	DP-5 	1	Only when PCON-CGB/CGFB
6	First Step Guide		1	Shown in the figure is an image.
7	Safety Guide		1	Shown in the figure is an image.
8	Instruction Manual (DVD)		1	Shown in the figure is an image.

1.1.2 Teaching Tool

A teaching tool such as PC software is necessary when performing the setup for position setting, parameter setting, etc. that can only be done on the teaching tool. Please prepare either of the following teaching tools.

No.	Part Name	Model
1	PC Software (Includes RS232C Adapter + Peripheral Communication Cable)	RCM-101-MW
2	PC Software (Includes USB Adapter + USB Cable + Peripheral Communication Cable)	RCM-101-USB
3	Touch Panel Teaching Pendant TB-01 (Standard Type / Deadman Switch Attached on the Left side Type / Deadman Switch Attached on the Right side Type)	TB-01/ TB-01D/ TB-01DR
4	Touch Panel Teaching Pendant TB-02 (Standard Type / Deadman Switch Type)	TB-02/TB-02D
5	Touch Panel Teaching Pendant TB-03 Wired Link	TB-03

1.1.3 Instruction Manuals Related to This Product, which are Contained in the Instruction Manual (DVD).

No.	Name	Manual No.
1	PCON-CB/CFB Controller Instruction Manual	ME0342
2	PC Software RCM-101-MW/ RCM-101-USB Instruction Manual	ME0155
3	Touch Panel Teaching Pendant TB-01/01D/01DR Applicable for Position Controller Instruction Manual	ME0324
4	Touch Panel Teaching Pendant TB-02/02D Applicable for Position Controller, ELECYLINDER Instruction Manual	ME0355
5	Touch Panel Teaching Pendant TB-03 Position Controller, ELECYLINDER Wired Link Instruction Manual	ME0376
6	CC-Link Instruction Manual	ME0254
7	CC-Link IE Field Instruction Manual	ME0389
8	CompoNet Instruction Manual	ME0220
9	DeviceNet Instruction Manual	ME0256
10	EtherCAT Instruction Manual	ME0273
11	EtherNet/IP Instruction Manual	ME0278
12	MECHATROLINK- I / II Instruction Manual	ME0221
13	PROFIBUS-DP Instruction Manual	ME0258
14	PROFINET IO Instruction Manual	ME0333
15	MECHATROLINK-III Instruction Manual	ME0317
16	Instruction Manual for the Serial Communication [for Modbus]	ME0162

1.1.4 How to Read the Model Plate

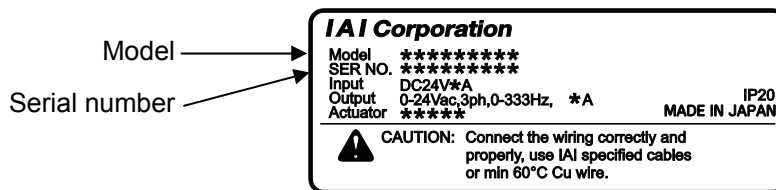

1.1.5 How to Read the Model

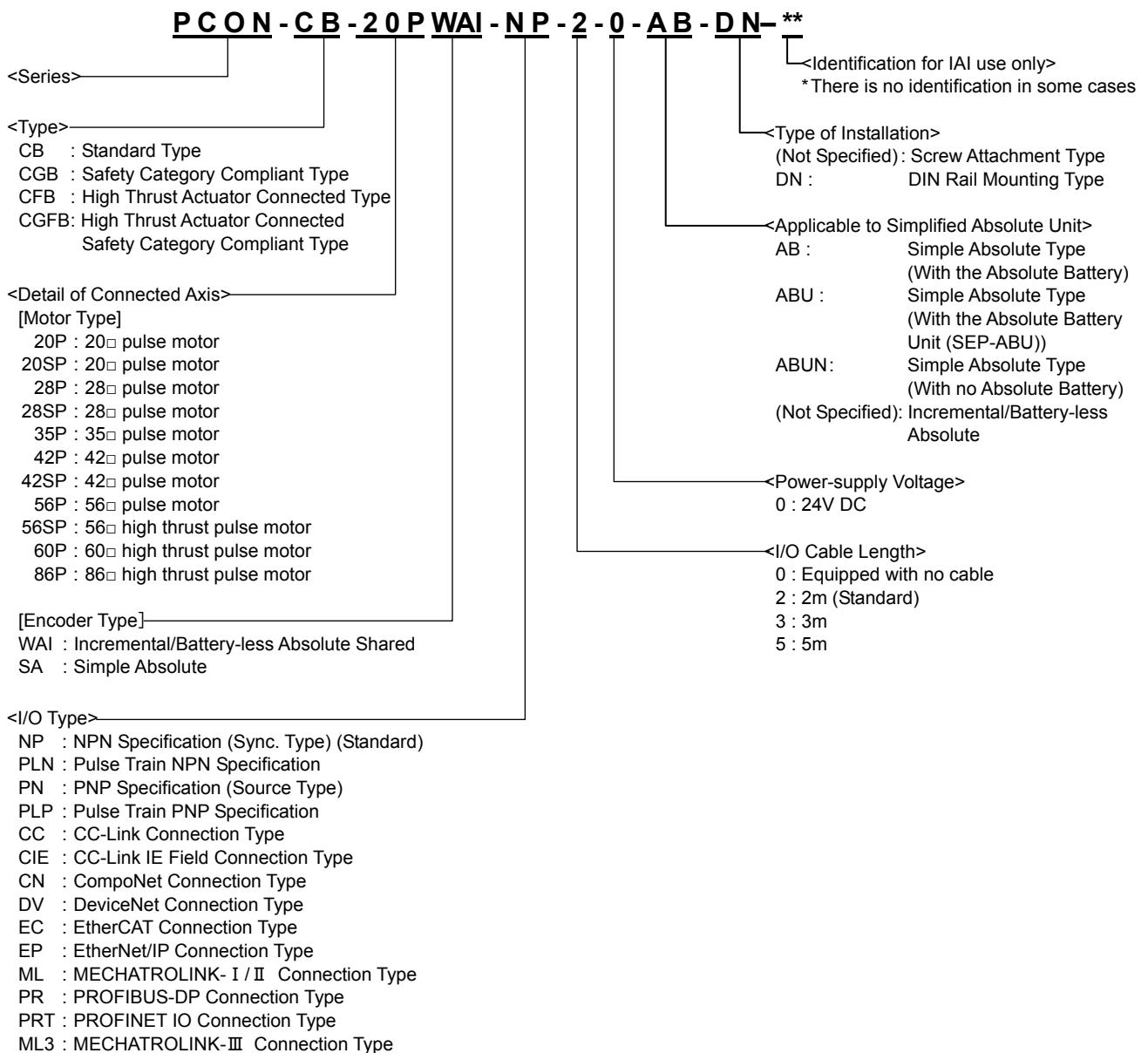

1.2 List of Basic Specifications

Item			PCON-CB/CGB		PCON-CFB/CGFB		
Number of controlled axes			1-axis				
Power-supply Voltage			24V DC $\pm 10\%$				
Load current (including control side current consumption) <small>(Note 1)</small>	RCP2 RCP3	Motor Type	20P, 28P	MAX. 1.0A			
			28SP, 35P, 42P, 56P	MAX. 2.2A			
	RCP4 RCP5 RCP6	Motor Type	28P, 35P, 42P, 42SP, 56P	High-thrust function is disabled	MAX. 2.2A		
			56SP, 60P, 86P	High-thrust function is enabled	Rated 3.5A / MAX. 4.2A		
Power Supply for Electromagnetic Brake (for actuator equipped with brake)			24V DC $\pm 10\%$ 0.15A (MAX.)		24V DC $\pm 10\%$ 0.5A (MAX.)		
Heat Generation		RCP2, RCP3	5W		19.2W		
		RCP4 to RCP6	8W				
Rush Current <small>(Note 2)</small>			8.3A		10A		
Transient Power Cutoff Durability			MAX. 500 μ s				
Motor Control System			Weak field-magnet vector control				
Corresponding Encoder		RCP2 to RCP5	Incremental encoder, Battery-less absolute encoder Resolution 800pulse/rev				
		RCP6	Battery-less absolute encoder Resolution 8192pulse/rev				
Motor/Encoder Cable Length			MAX. 20m				
Serial Communication Interface (SIO Port)			RS485 : 1 channel (based on Modbus Protocol RTU/ASCII) Speed : 9.6 to 230.4Kbps Control available with serial communication in the modes other than the pulse train				
External Interface		PIO Type	Signal I/O dedicated for 24V DC (selected from NPN/PNP) ... Input 16 points max., output 16 points max. Cable length MAX. 10m				
		Field Network Type	DeviceNet, CC-Link, CC-Link IE Field, PROFIBUS-DP, CompoNet, MECHATROLINK- I / II , EtherCAT, EtherNet/IP, PROFINET IO, MECHATROLINK-III				
Data Setting and Input			PC Software, Touch Panel Teaching Pendant				
Data Retention Memory			Saves position data and parameters to non-volatile memory (There is no limitation in number of writing.)				
Operation Mode			Positioner Mode/Pulse Train Control Mode (selected by parameter setting)				
Number of Positions in Positioner Mode			Standard 64 points, MAX. 512 points (Note) Number of positions differs depending on the selection in PIO pattern.				
Pulse Train Interface		Input Pulse	Differential System (Line Driver System) : MAX. 200kpps Cable length MAX. 10m Open Collector System : Not applicable. * If the host applies the open collector output, prepare AK-04 (option) separately to convert to the differential type.				
		Command Pulse Multiplying Factor (Electrical Gear : A/B)	1/50 < A/B < 50/1 Setting Range of A and B (set to parameter) : 1 to 4096				
		Feedback Pulse Output	None				

Item		PCON-CB/CGB	PCON-CFB/CGFB
LED Display (mounted on Front Panel)		SV (GN)/ALM (RD) : Servo ON/Alarm generated STS0 to 3 : Status display RDY (GN)/ALM (RD) : Absolute function in normal / absolute function error (for the simple absolute type) 1, 0 (GN) (RD) : Absolute function status display (for the simple absolute type)	
Electromagnetic Brake Compulsory Release Switch (mounted on Front Panel)		Switching NOM (standard)/BK RLS (compulsory release)	
Insulation Resistance		500V DC 10MΩ or more	
Protection Function against Electric Shock		Class I basic insulation	
Mass (Note 3)	Main Body (PIO Type)	Screw fixed type : 250g or less DIN rail fixed type : 285g or less	Screw fixed type : 270g or less DIN rail fixed type : 305g or less
	Main Body (Field Network Type)	Screw fixed type : 280g or less DIN rail fixed type : 315g or less	Screw fixed type : 300g or less DIN rail fixed type : 335g or less
	Simple Absolute Type	Battery (AB-7) : 190g or less Absolute battery case (SEP-ABU) : 140g	
Cooling Method		Natural air-cooling	Forced air-cooling
External dimensions		Screw fixed type : 35W×178.5H×69.6D DIN rail fixed type : 35W×185H×78.1D	Screw fixed type : 35W×190H×69.6D DIN rail fixed type : 35W×196.5H×78.1D
Environment	Surrounding Air Temperature	0 to 40°C	
	Surrounding Humidity	85% RH or less (non-condensing)	
	Surrounding Environment	[Refer to Installation Environment]	
	Surrounding Storage Temperature	-20 to 70°C (Excluding battery)	
	Usage Altitude	1000m or lower above sea level	
	Protection Class	IP20	
	Vibration Resistance	Frequency 10 to 57Hz / Swing width : 0.075mm Frequency 57 to 150Hz / Acceleration : 9.8m/s ² XYZ Each direction Sweep time : 10 min. Number of sweep: 10 times	

Note 1 Value increases in 0.3A for Field Network Type.

Note 2 In-rush current will flow for approximately 1 to 5ms after the power is turned on (at 40°C).
The value of inrush current differs depending on the impedance of the power supply line.

Note 3 Add the mass of the battery and battery case for Simple Absolute Type.

1.3 Appearance

1.3.1 CB Type.....For Battery-less Absolute/Incremental Screw-fixed Type

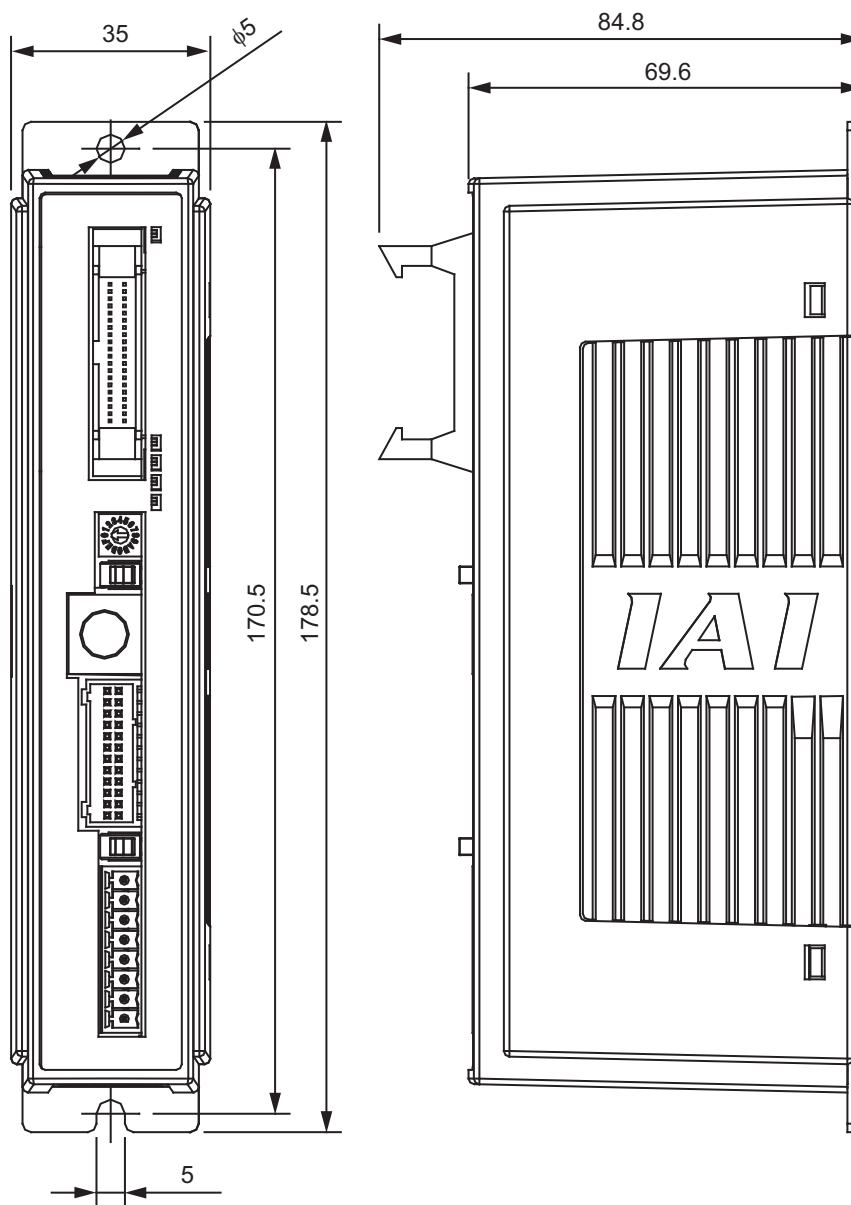

1.3.2 CB Type.....For Battery-less Absolute/Incremental DIN rail-fixed Type

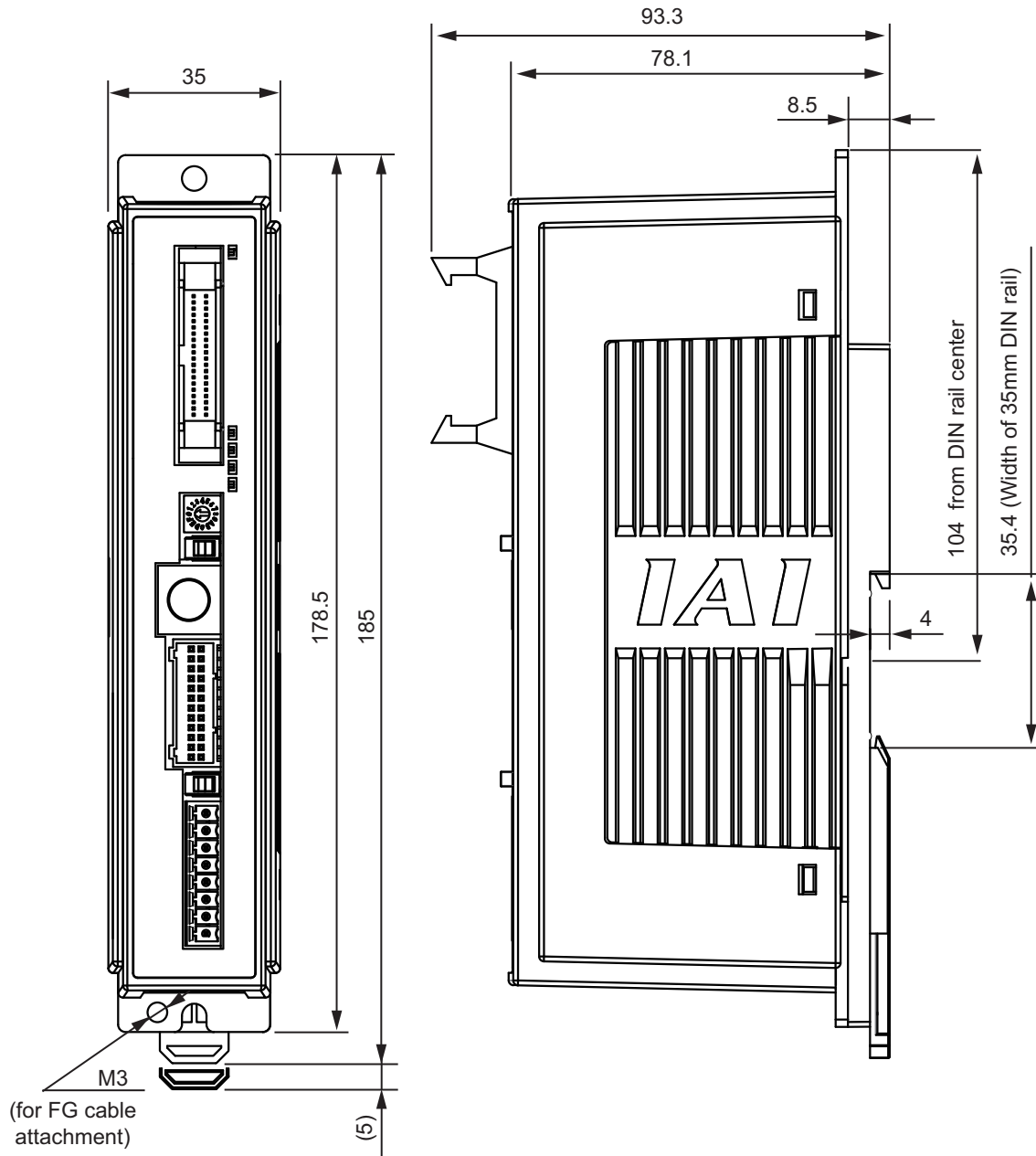

1.3.3 CB Type.....For Simple Absolute Screw-fixed Type

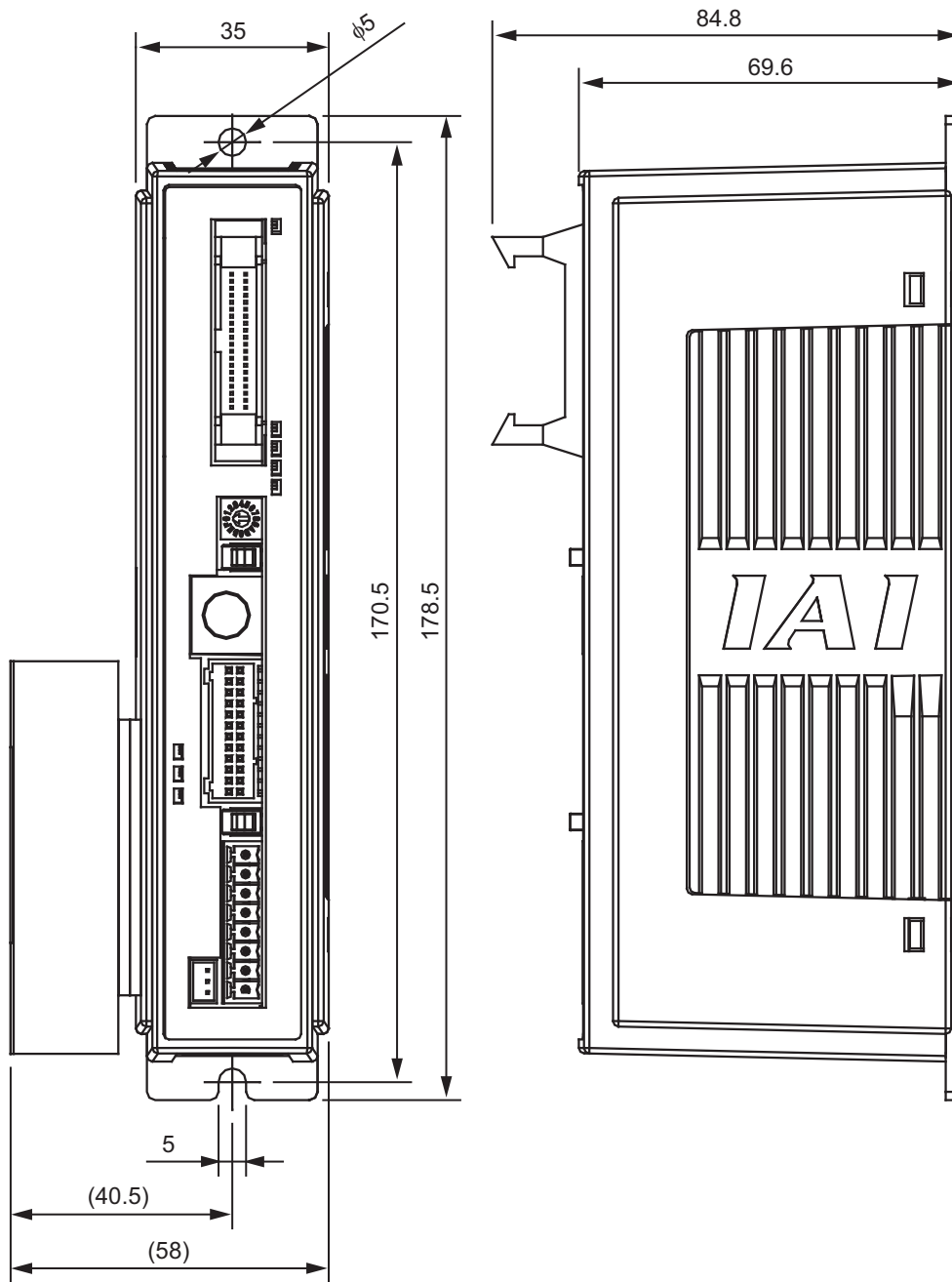

1.3.4 CB Type.....For Simple Absolute DIN rail-fixed Type

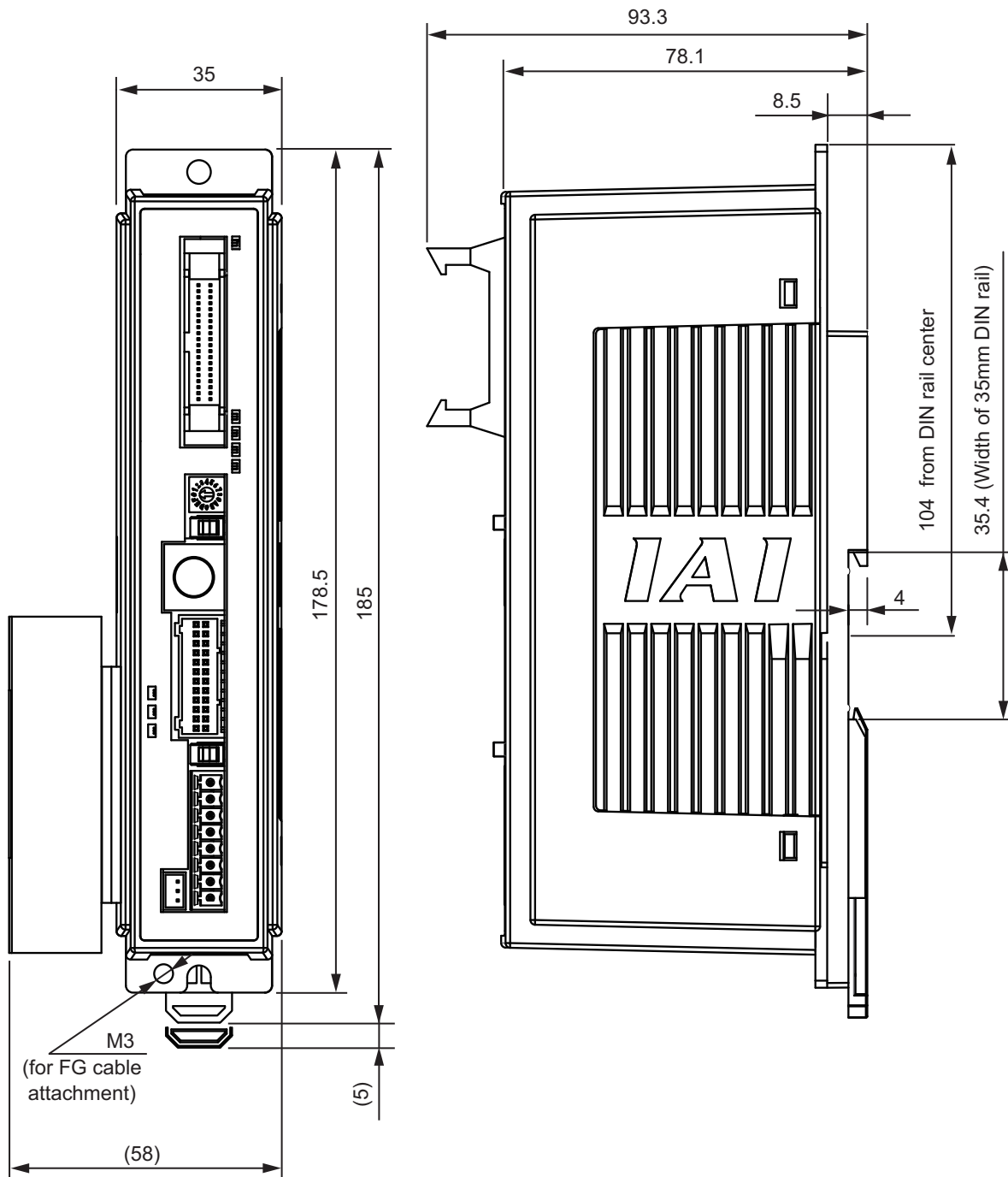

1.3.5 CFB Type.....For Incremental Screw-fixed Type

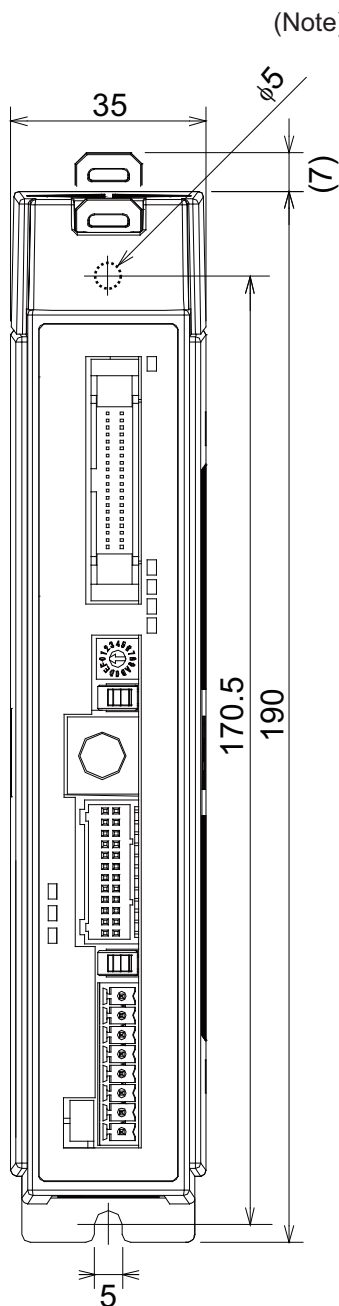

(Note) When using the attachment hole on the top of the controller, detach the fan unit temporarily.

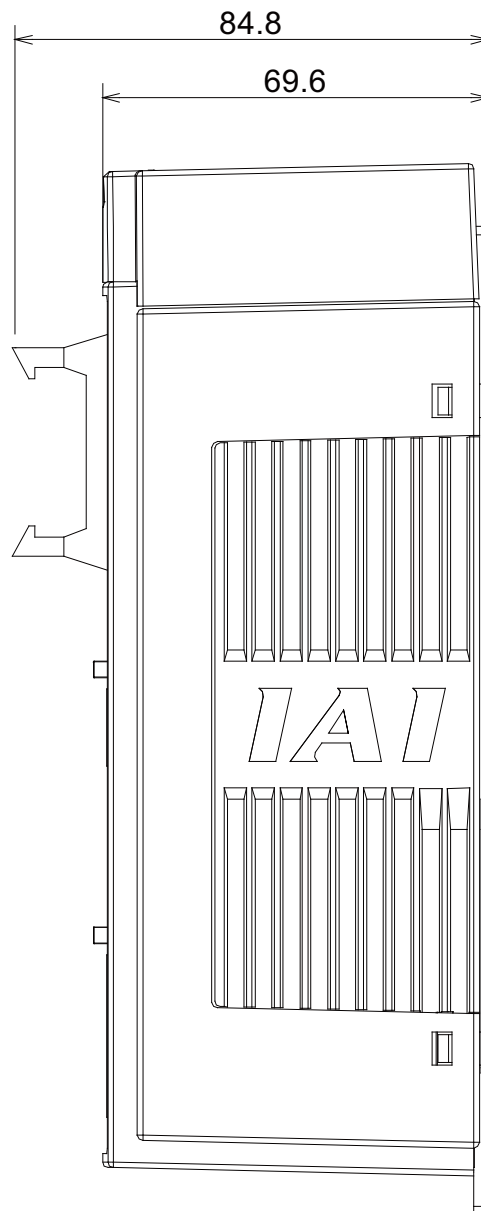

1.3.6 CFB Type.....For Incremental DIN rail-fixed Type

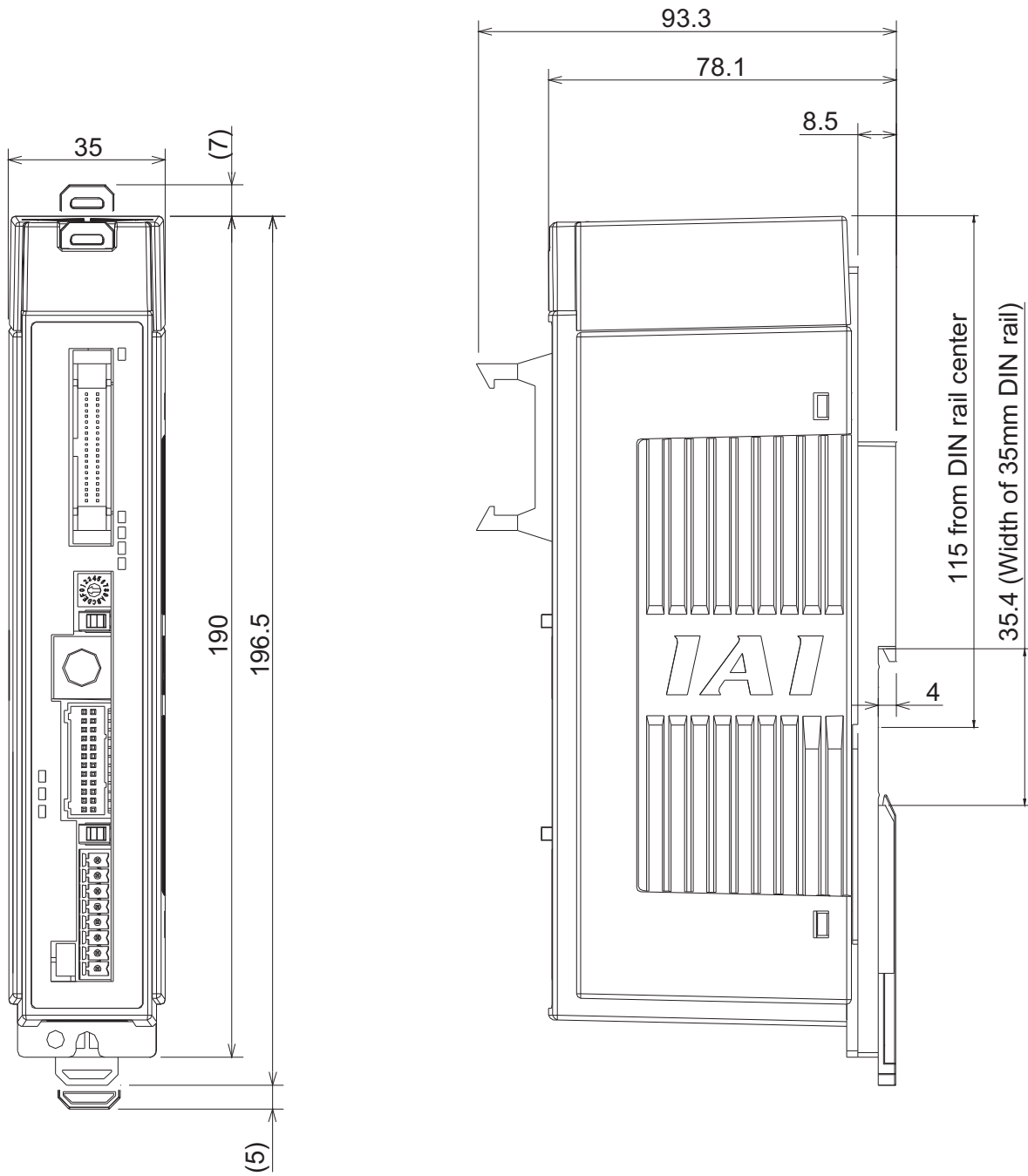

1.3.7 Absolute Battery Unit (Option for Simple Absolute Type)

1) DIN Rail Mounting Type

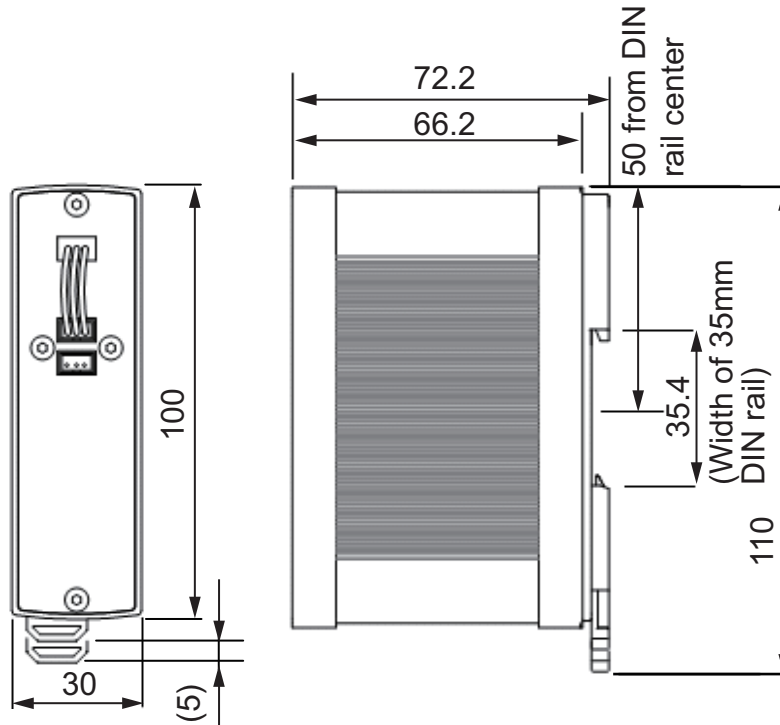

2) Screw Mounting Type

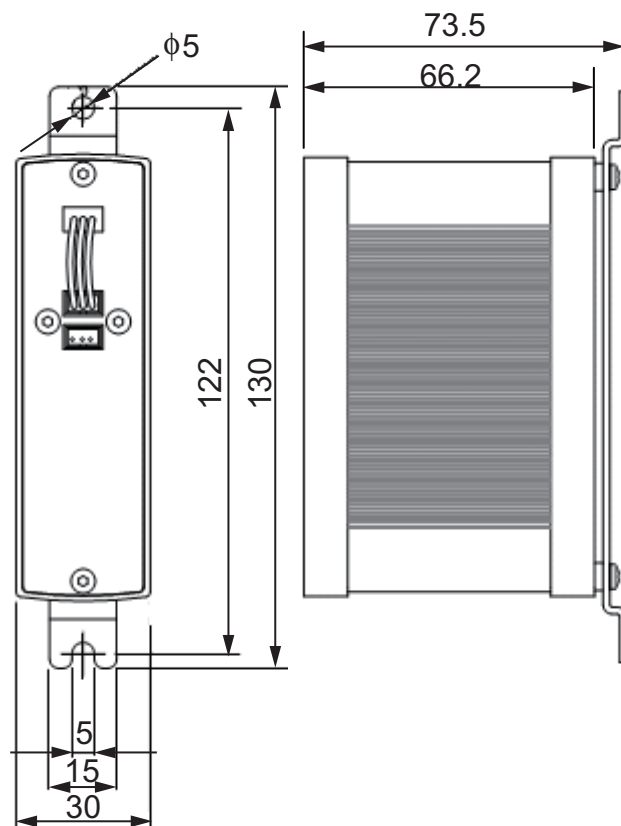

1.4 I/O Specifications

1.4.1 PIO Input and Output Interface

	Input Section		Output Section	
Specification	Input Voltage	24V DC $\pm 10\%$	Load Voltage	24V DC
	Input Current	5mA 1circuit	Peak Load Electric Current	50mA 1circuit
	ON/OFF Voltage	ON Voltage MIN. 18V DC OFF Voltage MAX. 6V DC	Leakage Current	MAX. 2mA/1point
NPN				
PNP				
I/O Cable	Refer to 2.1.3 [4] PIO Circuit			
Insulated	Insulation with Photocoupler			

NPN Specification

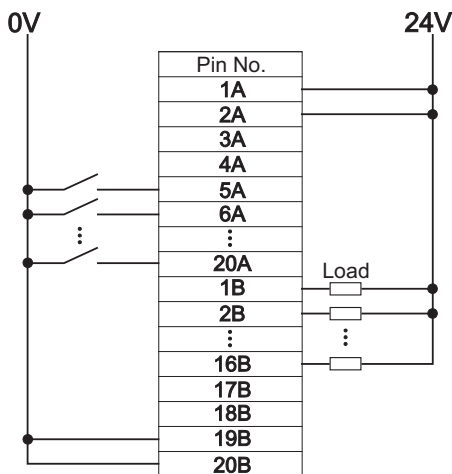

PNP Specification

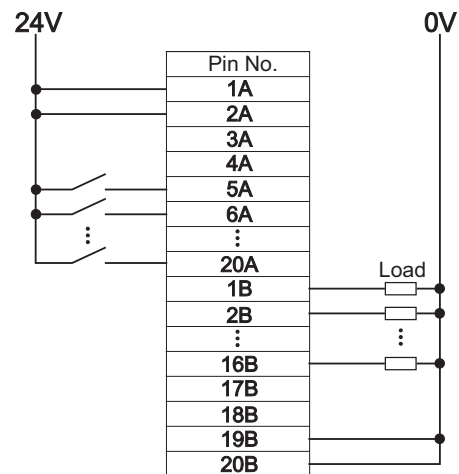

1.4.2 Pulse Train Input Output Interface

Line Driver Input	
Specification	<p>Sends input pulse (differential voltage: approx. 4V) from the host unit that is installed with a line driver 26C31 or equivalent</p> <p>The diagram illustrates the connection between a Host Unit and PCON. On the left, the Host Unit's Positioning Unit contains two differential line drivers. On the right, the PCON unit has four pins: PP, /PP, NP, and /NP. Four signal lines connect the Host Unit to PCON, with pulse waveforms shown on each line.</p>
Pulse Train Form	Including active high and active low

1.5 Options

1.5.1 Pulse converter : AK-04

The pulse converter converts command pulses in the open collector mode to those in the differential mode.

Use this converter if the host controller sends output pulses in the open collector mode.

Item	Specification
Input Power Supply	24V DC $\pm 10\%$ (MAX. 50mA)
Input Pulse	O/C (Collector current MAX. 12mA)
Input Frequency	200kpps or less
Output Pulse	Differential output equivalent to 26C31 (MAX. 10mA)
Mass	10g or less (excluding cable connector)
Accessories	37104-3122-000FL (e-CON Connector) 2 Units Cover Color : YW Applicable wire AWG No.24 to 26 (Less than 0.14 to 0.3mm ² , finished O.D. $\phi 1.0$ to 1.2mm)

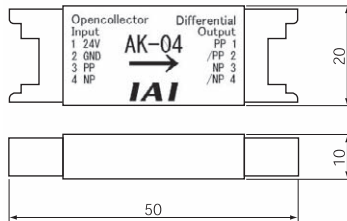

⚠ Caution

- 1) Use the pulse converter in the surrounding temperature range between 0°C and 40°C.
- 2) The temperature increase of about 30°C occurs during operation. Accordingly, neither install several pulse converters in close contact nor install them within a duct. Do not install the pulse converter near other heating devices.
- 3) If more than one pulse converter are installed, set a pulse converter apart from another by 10mm or more.
- 4) The device is not available for connection to a PNP pulse train type (Model Code: PLP) controller.

1.6 Installation and Storage Environment

This product is capable for use in the environment of pollution degree 2*¹ or equivalent.

*1 Pollution Degree 2 : Environment that may cause non-conductive pollution or transient conductive pollution by frost (IEC60664-1)

[1] Installation Environment

Do not use this product in the following environment.

- Location where the surrounding air temperature exceeds the range of 0 to 40°C
- Location where condensation occurs due to abrupt temperature changes
- Location where relative humidity exceeds 85%RH
- Location exposed to corrosive gases or combustible gases
- Location exposed to significant amount of dust, salt or iron powder
- Location subject to direct vibration or impact
- Location exposed to direct sunlight
- Location where the product may come in contact with water, oil or chemical droplets
- Environment that blocks the air vent [Refer to 1.7 Noise Elimination and Mounting Method]

When using the product in any of the locations specified below, provide a sufficient shield.

- Location subject to electrostatic noise
- Location where high electrical or magnetic field is present
- Location with the mains or power lines passing nearby

[2] Storage and Preservation Environment

- Storage and preservation environment follows the installation environment. Especially in a long-term storage, consider to avoid condensation of surrounding air. Unless specially specified, moisture absorbency protection is not included in the package when the machine is delivered. In the case that the machine is to be stored in an environment where dew condensation is anticipated, take the condensation preventive measures from outside of the entire package, or directly after opening the package.

1.7 Noise Elimination and Mounting Method

(1) Noise Elimination Grounding (Frame Ground)

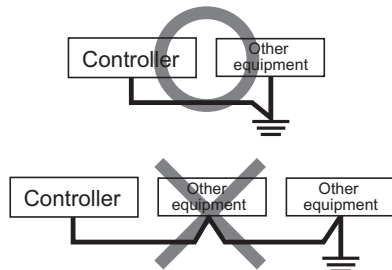
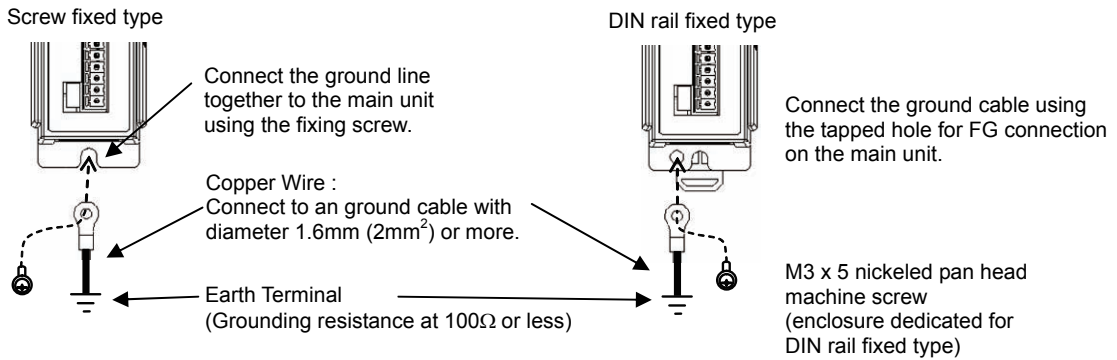

Do not share the ground wire with or connect to other equipment. Ground each controller.

(2) Precautions regarding wiring method

- 1) Wire is to be twisted for the power supply.
- 2) Separate the signal and encoder lines from the power supply and power lines.

(3) Noise Sources and Elimination

Carry out noise elimination measures for electrical devices on the same power path and in the same equipment. The following are examples of measures to eliminate noise sources.

- 1) AC solenoid valves, magnet switches and relays
[Measure] Install a Surge absorber parallel with the coil.
- 2) DC solenoid valves, magnet switches and relays
[Measure] Mount the windings and diodes in parallel.
Select a diode built-in type for the DC relay.

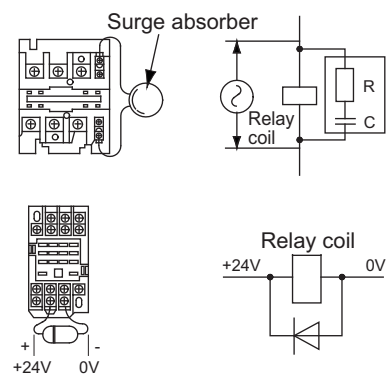

(4) Heat Radiation and Installation

Design and Build the system considering the size of the controller box, location of the controller and cooling factors to keep the surrounding temperature around the controller below 40°C.

To fix the units in the control box, use the attachment holes on top and bottom of the unit for the screw fixed type, and use the DIN rails for the DIN rail fixed type.

Install in the orientation shown in the figure below for heat radiation.

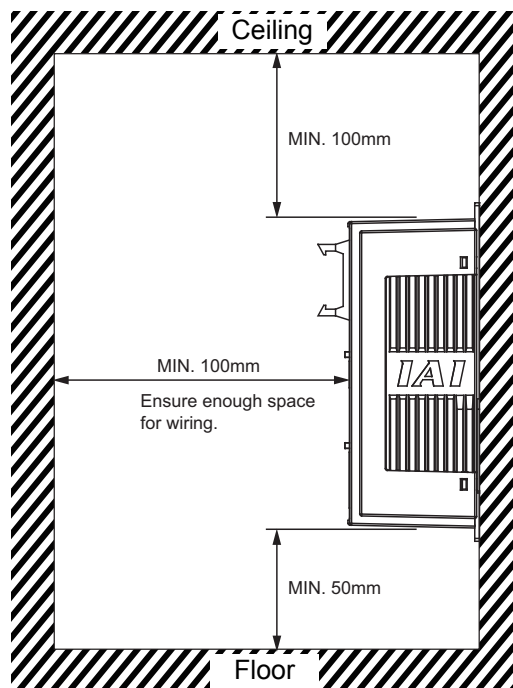
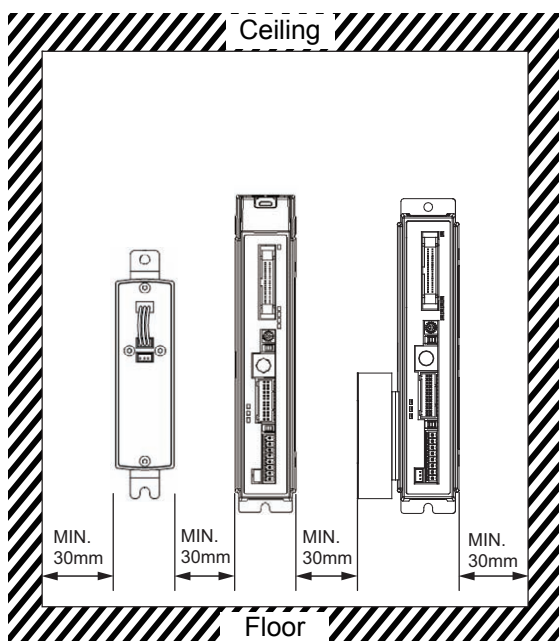

(5) Installation of CFB Type

For CFB (screw fixed type), detach the fan unit temporarily and use the attachment hole on the top. [Refer to 9.4.3 Replacement of Fan]

Chapter 2 Wiring

2.1 Positioner Mode (PIO Control)

2.1.1 Wiring Diagram (Connection of Devices)

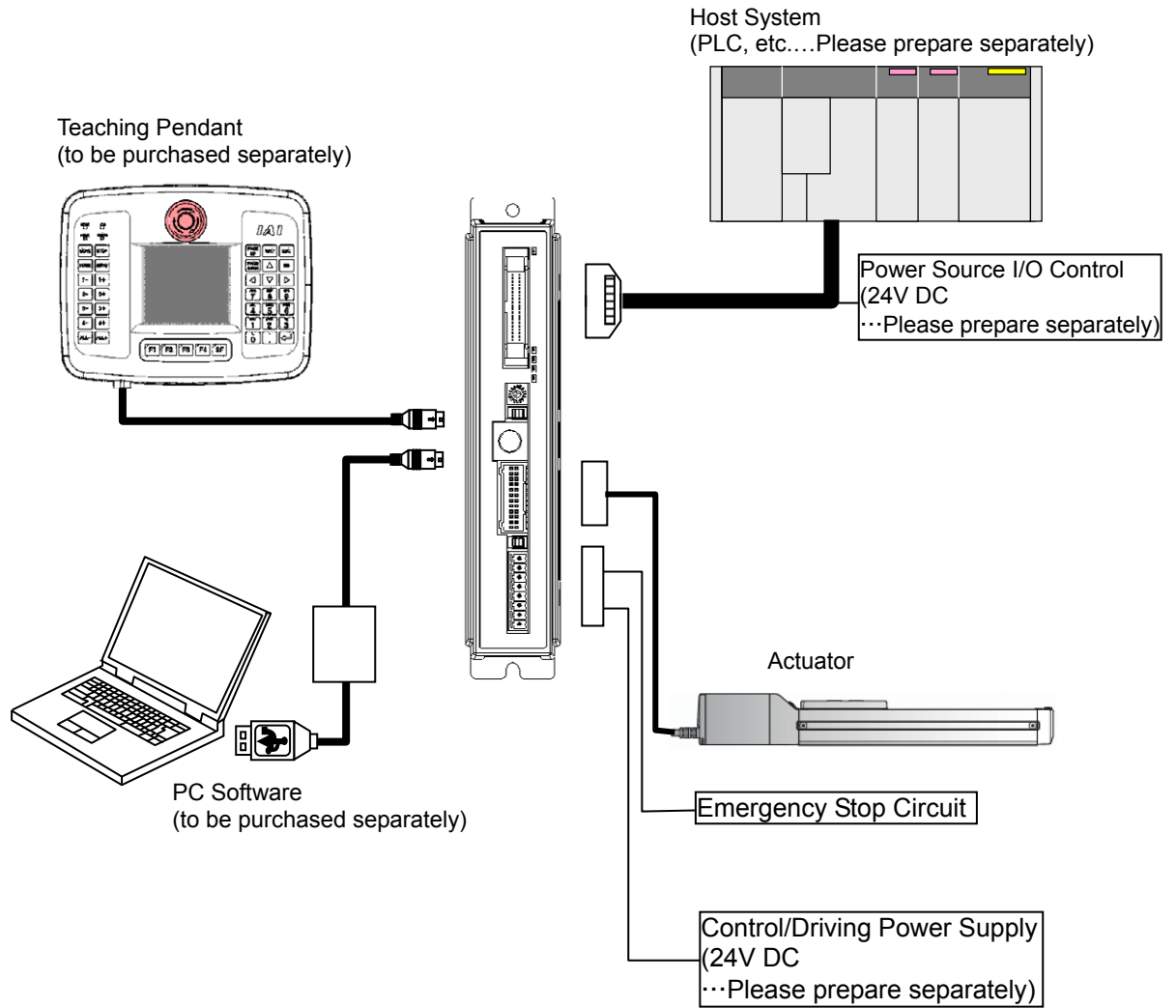

Caution : Make sure to turn the power to the controller OFF when inserting or removing the connector that connects the PC software or teaching pendant to the controller. Inserting or removing the connector while the power is turned ON causes a controller failure.

2.1.2 PIO Pattern Selection and PIO Signal

(1) PIO Pattern (Control Pattern) Selection

The controller provides 8 PIO patterns (Control patterns). Set the most suitable PIO pattern with the actual use to Parameter No. 25 "PIO Pattern Select".

Refer to "3.2 Operation in Positioner Mode" for the details of PIO patterns.

Type	Value set in parameter No. 25	Mode	Overview
PIO Pattern 0	0 (at the delivery)	Positioning Mode (Standard Type)	<ul style="list-style-type: none"> • Number of positioning points : 64 points • Position command : binary code • Zone signal output*1 : 1 point^(Note 2) • Position zone signal output*2 : 1 point^(Note 2)
PIO Pattern 1	1	Teaching mode (Teaching type)	<ul style="list-style-type: none"> • Number of positioning points : 64 points • Position command : binary code • Position zone signal output*2 : 1 point^(Note 2) • Jog operation enabled by PIO signal • Writing current position data to position table enabled by PIO signal
PIO Pattern 2	2	256-point mode (Number of positioning points : 256-point type)	<ul style="list-style-type: none"> • Number of positioning points : 256 points • Position command : binary code • Position zone signal output*2 : 1 point^(Note 2)
PIO Pattern 3	3	512-point mode (Number of positioning points : 512-point type)	<ul style="list-style-type: none"> • Number of positioning points : 512 points • Position command : binary code • Zone signal output : None
PIO Pattern 4	4	Solenoid Valve Mode 1 (7-point type)	<ul style="list-style-type: none"> • Number of positioning points : 7 points • Position command : Individual number signal ON • Zone signal output*1 : 1 point^(Note 2) • Position zone signal output*2 : 1 point^(Note 2)
PIO Pattern 5	5	Solenoid Valve Mode 2 (3-point type)	<ul style="list-style-type: none"> • Number of positioning points : 3 points • Position command : Individual number signal ON • Completion signal : Signal equivalent to LS (limit switch) enabled • Zone signal output*1 : 1 point^(Note 2) • Position zone signal output*2 : 1 point^(Note 2)
PIO Pattern 6 (Note 1)	6	Pulse Train Control Mode for Incremental [Refer to 2.2]	<ul style="list-style-type: none"> • Differential pulse input (MAX. 200kpps) • Home return function • Zone signal output*1 : 2 point • No feedback pulse output
PIO Pattern 7 (Note 1)	7	Pulse Train Control Mode for Absolute [Refer to 2.2]	<ul style="list-style-type: none"> • Setting the datum point (1 places) • Differential pulse input (MAX. 200Kpps) • Home return function • Zone signal output*1 : 2 point • No feedback pulse output

*1 Zone signal output : Zone range is to be set to either Parameter No.1, 2 or No.23, 24 and it is always available after the home-return operation is complete.

*2 Position zone signal output : This feature is associated with the specified position number. The zone range is set in the position table. The zone range is enabled only when the position is specified but disabled if another position is specified.

Note 1 Pulse Train Control Mode is available only if the pulse train control type is indicated (from PCON-CB-*-PLN and PLP) at the purchase.

Note 2 Position Zone Signal can be switched over to Zone Signal with the setting of Parameter No.149.

(2) PIO Patterns and Signal Assignment

The signal assignment of I/O flat cable by the PIO pattern is as shown below. Follow the following table to connect the external equipment (such as PLC).

Pin No.	Category	PIO Functions	Parameter No.25 "PIO Pattern" Selection			
			0	1	2	3
			Positioning mode	Teaching mode	256-point mode	512-point mode
	Input	Number of positioning points	64 points	64 points	256 points	512 points
		Home return signal	○	○	○	○
		Jog signal	×	○	×	×
		Teaching signal (Current position writing)	×	○	×	×
	Output	Brake release	○	×	○	○
		Moving signal	○	○	×	×
		Zone signal	○	Δ ^(NOTE 1)	Δ ^(NOTE 1)	×
		Position zone signal	○	○	○	×
1A	24V	P24				
2A	24V	P24				
3A	—	—				
4A	—	—				
5A	Input	IN0	PC1	PC1	PC1	PC1
6A		IN1	PC2	PC2	PC2	PC2
7A		IN2	PC4	PC4	PC4	PC4
8A		IN3	PC8	PC8	PC8	PC8
9A		IN4	PC16	PC16	PC16	PC16
10A		IN5	PC32	PC32	PC32	PC32
11A		IN6	—	MODE	PC64	PC64
12A		IN7	—	JISL	PC128	P128
13A		IN8	—	JOG+	—	PC256
14A		IN9	BKRL	JOG-	BKRL	BKRL
15A		IN10	RMOD	RMOD	RMOD	RMOD
16A		IN11	HOME	HOME	HOME	HOME
17A		IN12	*STP	*STP	*STP	*STP
18A		IN13	CSTR	CSTR/PWRT	CSTR	CSTR
19A		IN14	RES	RES	RES	RES
20A	IN15	SON	SON	SON	SON	
1B	Output	OUT0	PM1(ALM1)	PM1(ALM1)	PM1(ALM1)	PM1(ALM1)
2B		OUT1	PM2(ALM2)	PM2(ALM2)	PM2(ALM2)	PM2(ALM2)
3B		OUT2	PM4(ALM4)	PM4(ALM4)	PM4(ALM4)	PM4(ALM4)
4B		OUT3	PM8(ALM8)	PM8(ALM8)	PM8(ALM8)	PM8(ALM8)
5B		OUT4	PM16	PM16	PM16	PM16
6B		OUT5	PM32	PM32	PM32	PM32
7B		OUT6	MOVE	MOVE	PM64	PM64
8B		OUT7	ZONE1	MODES	PM128	PM128
9B		OUT8 ^(NOTE1)	PZONE/ZONE2	PZONE/ZONE1	PZONE/ZONE1	PM256
10B		OUT9	RMDS	RMDS	RMDS	RMDS
11B		OUT10	HEND	HEND	HEND	HEND
12B		OUT11	PEND	PEND/WEND	PEND	PEND
13B		OUT12	SV	SV	SV	SV
14B		OUT13	*EMGS	*EMGS	*EMGS	*EMGS
15B		OUT14	*ALM	*ALM	*ALM	*ALM
16B	OUT15	LOAD/TRQS *ALML	*ALML	LOAD/TRQS *ALML	LOAD/TRQS *ALML	
17B	—	—				
18B	—	—				
19B	0V	N				
20B	0V	N				

(Note) "*" in codes above shows the signal of the active low.
 PM1 to PM8 indicate the alarm binary code output signal when an alarm is generated. [Refer to 3.2.3 [7] Binary Output of Alarm Data Output]

Note 1 The mode can be switched over to PZONE with the setting of Parameter No.149 except for PIO Pattern 3.

(Reference) Signal of Active Low

Signal with "*" expresses the signal of active low. A signal of active low is a signal that the input signal is processed when it is turned OFF, output signal is ordinarily (or just omit) on while the power is ON, and turns OFF when the signal is output.

Pin No.	Category	PIO Functions	Parameter No.25 "PIO Pattern" Selection		
			4	5	6 or 7
			Solenoid Valve Mode 1	Solenoid Valve Mode 2	Pulse Train Control Mode
	Input	Number of positioning points	7 points	3 points	–
		Home return signal	○	×	○
		Jog signal	×	×	×
		Teaching signal (Current position writing)	×	×	×
		Brake release	○	○	○
	Output	Moving signal	×	×	×
		Zone signal	○	○	○
		Position zone signal	○	○	×
1A	24V	P24			
2A	24V	P24			
3A	Pulse input	–			
4A		–			
5A	Input	IN0	ST0	ST0	
6A		IN1	ST1	ST1(JOG+)	
7A		IN2	ST2	ST2 (Note 2)	
8A		IN3	ST3	–	
9A		IN4	ST4	–	
10A		IN5	ST5	–	
11A		IN6	ST6	–	
12A		IN7	–	–	
13A		IN8	–	–	
14A		IN9	BKRL	BKRL	
15A		IN10	RMOD	RMOD	
16A		IN11	HOME	–	
17A		IN12	*STP	–	
18A		IN13	–	–	
19A		IN14	RES	RES	
20A	IN15	SON	SON		
1B	Output	OUT0	PE0	LS0	
2B		OUT1	PE1	LS1(TRQS)	
3B		OUT2	PE2	LS2 (Note 2)	
4B		OUT3	PE3	–	
5B		OUT4	PE4	–	
6B		OUT5	PE5	–	
7B		OUT6	PE6	–	
8B		OUT7	ZONE1	ZONE1	
9B		OUT8 (Note 1)	PZONE/ZONE2	PZONE/ZONE2	
10B		OUT9	RMDS	RMDS	
11B		OUT10	HEND	HEND	
12B		OUT11	PEND	–	
13B		OUT12	SV	SV	
14B		OUT13	*EMGS	*EMGS	
15B		OUT14	*ALM	*ALM	
16B	OUT15	LOAD/TRQS *ALML	*ALML		
17B	Pulse input	–			
18B		–			
19B	0V	N			
20B	0V	N			

Refer to Section 2.2 for the details of Pulse Train Control Mode

(Note) Shown in () after the signal names above tell the functions performed before the home-return operation. "*" in codes above shows the signal of the active low. PM1 to PM8 indicate the alarm binary code output signal when an alarm is generated. [Refer to 3.2.3 [7] Binary Output of Alarm Data Output]

Note1 The mode can be switched over to PZONE with the setting of Parameter No.149.

Note2 It is invalid before home-return operation.

(3) List of PIO Signals

The table below lists the functions of PIO signals. Refer to the section shown in Relevant Sections for the details of the control of each signal.

Category	Signal Abbreviation	Signal Name	Function Description	Relevant Sections
Input	CSTR	PTP strobe (Start signal)	The actuator will start to move to the position set by the command position number.	3.2.4
	PC1 to PC256	Command position number	Input (in binary) a number of the position that is desired to move.	3.2.4
	BKRL	Brake forcible release	The brake will forcibly be released.	3.2.3
	RMOD	Operation mode changeover	The operating mode is selectable when the MODE switch of the controller is set to AUTO. (The setting is AUTO when signal is OFF, and MANU when ON.)	3.2.3
	*STP	Pause	When this signal turns OFF while the actuator is moving, the actuator will decelerate to stop. The remaining movement is in a hold while the actuator is stopped and will resume when the signal turns back ON.	3.2.4 3.2.5 3.2.6
	RES	Reset	An alarm will be reset when this signal is turned ON. Also, when it is turned ON in the pause mode (*STP is turned OFF), the remaining movement amount can be cancelled.	3.2.3 3.2.4 3.2.5 3.2.6
	SON	Servo ON	The servo remains ON while this signal is ON, or OFF while this signal is OFF.	3.2.3
	HOME	Home return	The controller will perform home return operation when this signal is turned ON.	3.2.3
	MODE	Teaching mode	The operating mode will change to the teaching mode when this signal is turned ON. The mode will not be switched over unless CSTR, JOG+ and JOG- are all OFF and the actuator operation is stopped.	3.2.4
	JISL	Jog/inching selector	Jog Operation can be performed with JOG+ and JOG- while this signal is OFF. Inching Operation is performed with JOG+ and JOG- when it is ON.	3.2.4
	JOG + JOG -	Jog	Jog Operation is performed to positive direction by detecting ON edge of JOG+ signal and to negative direction by JOG- signal while JISL signal is OFF. The actuator will decelerate and stop if OFF edge is detected while in each Operation. Inching Operation is performed while JISL signal is ON.	3.2.4
	PWRT	Current Position Write	When the write position is specified in the teaching mode and this signal has remained ON for 26ms or longer, the controller will write the current position in the specified position field.	3.2.4
	ST0 to ST6	Start Signal	The actuator moves to the commanded position with this signal ON during the solenoid valve mode.	3.2.5 3.2.6

Signal with "*" expresses the signal of active low. In the controller, the process is held when the input signal is turned OFF.

Category	Signal Abbreviation	Signal Name	Function Description	Relevant Sections
Output	PEND/INP	Position complete	Turns ON in the positioning band range after actuator operation. The INP signal will turn OFF if the position deviation exceeds the in-position range. PEND and INP can be switched over by the parameter.	3.2.3 3.2.4 3.2.5
	PM1 to PM256	Completion Position No.	The position No. reached after the positioning completion, is output (binary output).	3.2.3 3.2.4
	HEND	Home return completion	This signal will turn ON when home return has been completed. It will be kept ON unless the home position is lost.	3.2.3 3.2.6
	ZONE1 ZONE2	Zone	Turns ON if the current actuator position is within the range set to the parameter.	3.2.3
	PZONE	Position zone	This signal will turn ON when the current actuator position enters the range specified the position data after position movement. Even though it can be used together with ZONE1, PZONE will become only available for operation by the set position number.	3.2.3
	RMDS	Operation Mode Status Output	Outputs the operation mode status. It turns on when the controller is on Manual Mode.	3.2.3
	*ALM	Alarm	Turns ON when the controller is in normal condition, and turns OFF when an alarm is generated.	3.2.3
	ALM1 to ALM8	Alarm Code	The detail of the alarm is output with binary code when an alarm more than the operation cancel level is issued.	3.2.3
	MOVE	Moving	Turns ON during the actuator is moving (including home-return operation and pressing operation).	3.2.3 3.2.4
	SV	Servo ON	This signal will remain ON while the servo is ON.	3.2.3
	*EMGS	Emergency Stop Output	This signal remains ON while the controller is under the emergency stop reset condition and turns OFF when the emergency stop condition is enabled. (Regardless of alarms.)	3.2.3
	MODES	Teaching Mode Output	This signal will turn ON while the teaching mode is enabled by the input of the mode signal and will turn OFF when the mode changes to the normal mode.	3.2.4
	WEND	Writing Complete	It is OFF during the teaching mode and turns ON when the writing by PWRT Signal is complete. It turns OFF when PWRT Signal turns OFF.	3.2.4
	PE0 to PE6	Current Position Number	In the solenoid valve mode, this signal will turn ON when the actuator completes moving to the target position.	3.2.5
	LS0 to LS2	Limit Switch Output	Turns ON when the current actuator position is within the range of positioning band (\pm) of the target position. It is output even before the movement command and the servo is OFF if the home-return operation is completed.	3.2.6
	*ALML	Light Error Output	Outputs when a message level alarm is generated ^(Note 1) .	8.4
	LOAD ^(Note 2)	Load output judgment status	It turns ON when the pressing current exceeds the current set in "Threshold" in the position data for a certain period of time ^(Note 3) when the actuator in the pressing operation range and also in the range of "Zone +" and "Zone -" in the position data. It should be used in such cases as judgment if press-fitting operation is conducted in normal condition. Also, it turns ON when collision is detected (judged) in the collision detection feature.	3.2.4 3.2.5 5.1
TRQS ^(Note 2)	Torque level status	It turns ON when the pressing current exceeds the current set in "Threshold" in the position data for a certain period of time ^(Note 3) when the actuator in the pressing operation range. It turns OFF if the current falls below "Threshold". It should be used in such cases as judgment if press-fitting operation is conducted in normal condition. It turns ON when the actuator hits an obstacle or the stroke end and become unable to move during movement to the positive direction with JOG+ before performing the home-return operation and the current of the motor exceeds the home-return current limit value in Solenoid Valve Mode 2.	3.2.4 3.2.5 3.2.6	

Signal with "*" expresses the signal of active low. It is ON when the power is applied to the controller, and turns OFF when the signal is output.

Note 1 It should be set in Parameter No. 156. [Refer to 7.2 [88]]

Note 2 This signal is dedicated for High-Thrust Actuator (CFB type) only. Use this as a reference output for other actuators. LOAD Signal and TRQS Signal are able to switch in Parameter No. 51. [Refer to 7.2 [40]]

Note 3 It should be set in Parameter No. 50. [Refer to 7.2 [39]]

2.1.3 Wiring

[1] Power Supply Connector (for Power Supply and Emergency Stop)

As an example of a circuit, cases of 4 conditions are shown. Select from 3) or 4) for CGB type.

- 1) Operate actuator without using the emergency stop input (EMG-)
- 2) Operate actuator with the emergency stop input (EMG-) activated
- 3) Stop supplying external motor power at emergency stop input
- 4) Shut off the motor power externally by inputting the emergency stop with using two units of controllers or more.

1) Operate actuator without using the emergency stop input (EMG-)

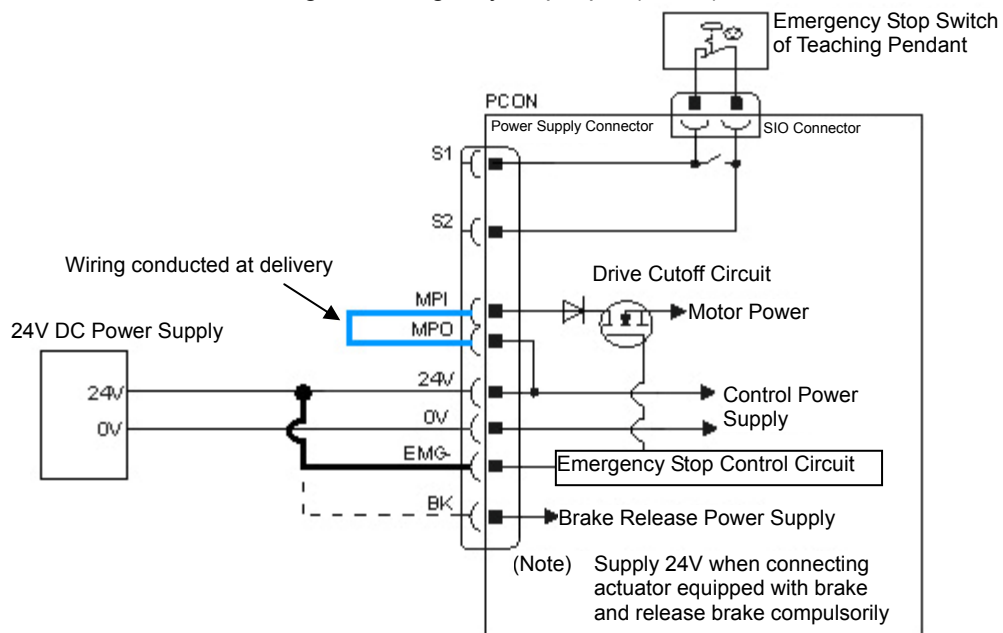

The emergency stop to the controller gets inactivated by supplying +24V continuously to EMG- Terminal. The emergency stop switch on the teaching pendant should be inactivated when S1 and S2 are not wired.

• Image of Wiring

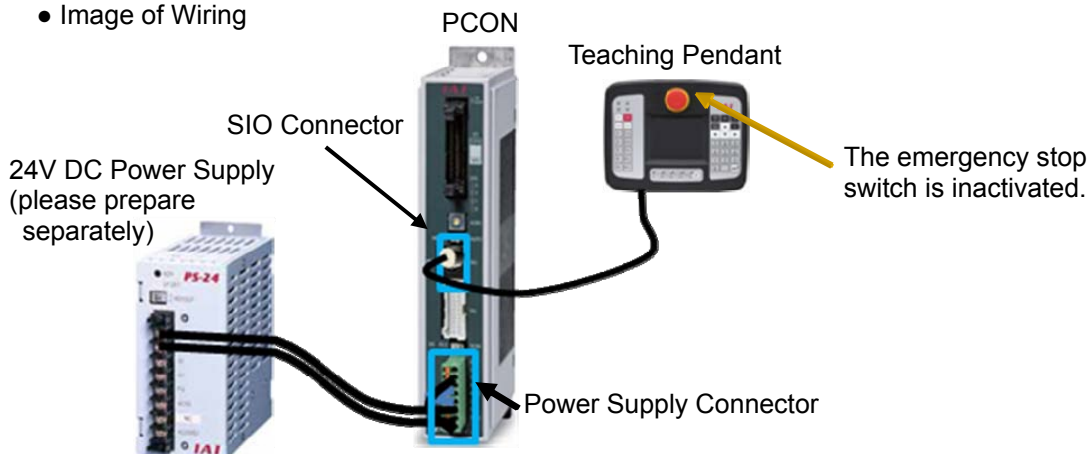

⚠ Caution ∴ When supplying the power by turning on/off the 24V DC, keep the 0V being connected and have the +24V supplied/disconnected (cut one side only).

- The rating for the emergency stop signal (EMG-) is 24V DC and 10mA or less.
- Leave for 1 sec or more after shutting the power off before rebooting.
- Do not attempt to supply only the monitor power without supplying the control power.

2) Example for wiring to operate actuator with the emergency stop input (EMG-) activated

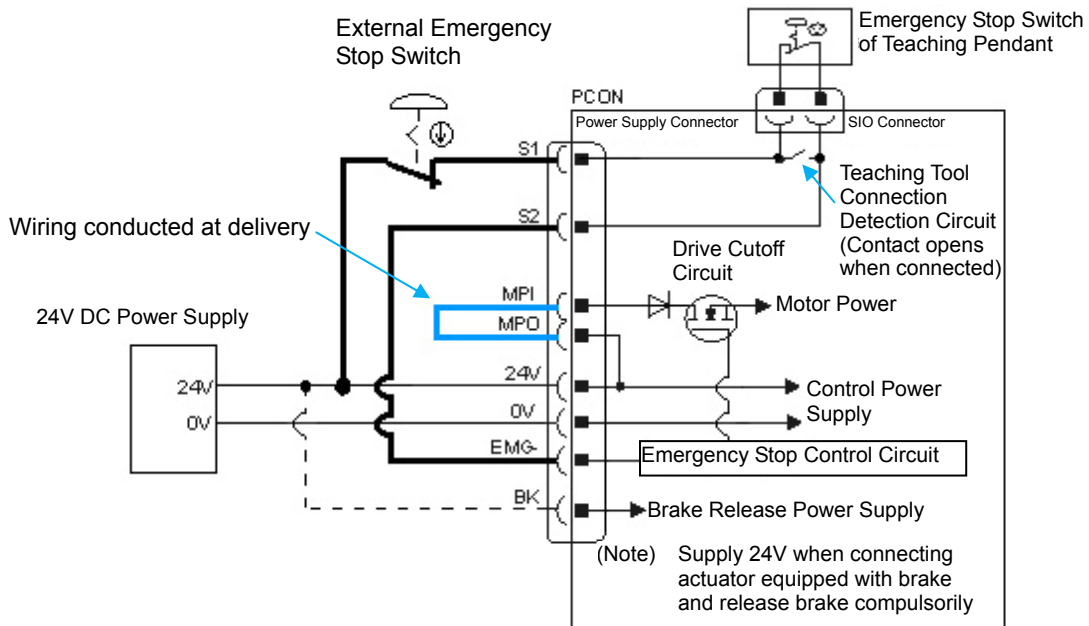

The emergency stop gets released when +24V is supplied to EMG- Terminal on the controller, and emergency stop activates if the power supply is shut, and stops the actuator operation, turns the servo OFF and cuts off the motor power supply inside the controller. Have an external emergency stop switch connected, and connect +24V to EMG- Terminal via the emergency stop switch ON the teaching pendant. +24V supply to EMG- terminal should get shut off when an external emergency stop switch or an emergency stop switch on the teaching pendant is turned ON, and the condition should get into the emergency stop status.

• Image of Wiring

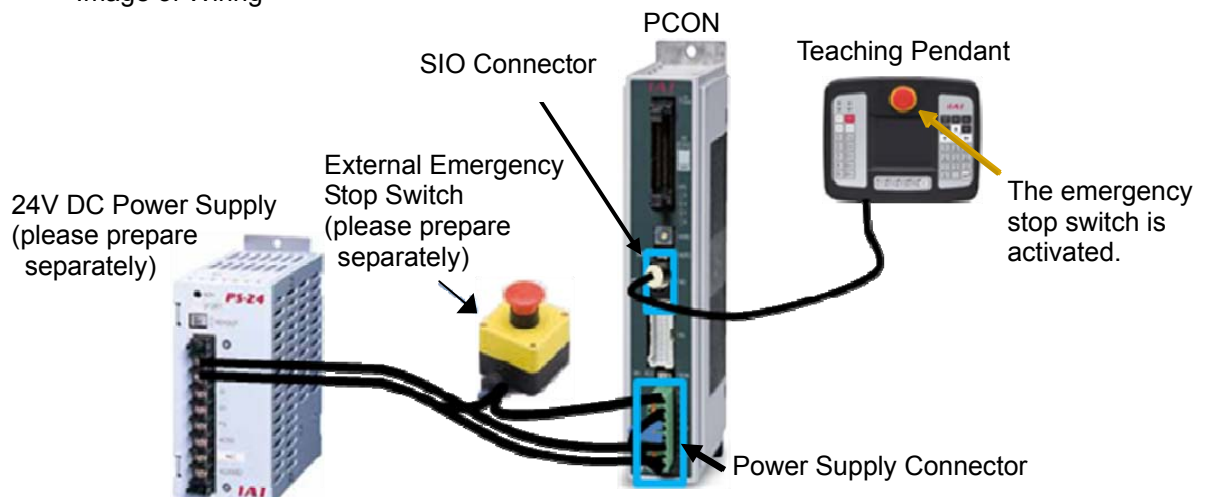

⚠ Caution : When supplying the power by turning ON/OFF the 24V DC, keep the 0V being connected and have the +24V supplied/disconnected (cut one side only).

- The rating for the emergency stop signal (EMG-) is 24V DC and 10mA or less.
- Leave for 1 sec or more after shutting the power off before rebooting.
- Do not attempt to supply only the monitor power without supplying the control power.

3) Example for wiring to stop supplying external motor power at emergency stop input

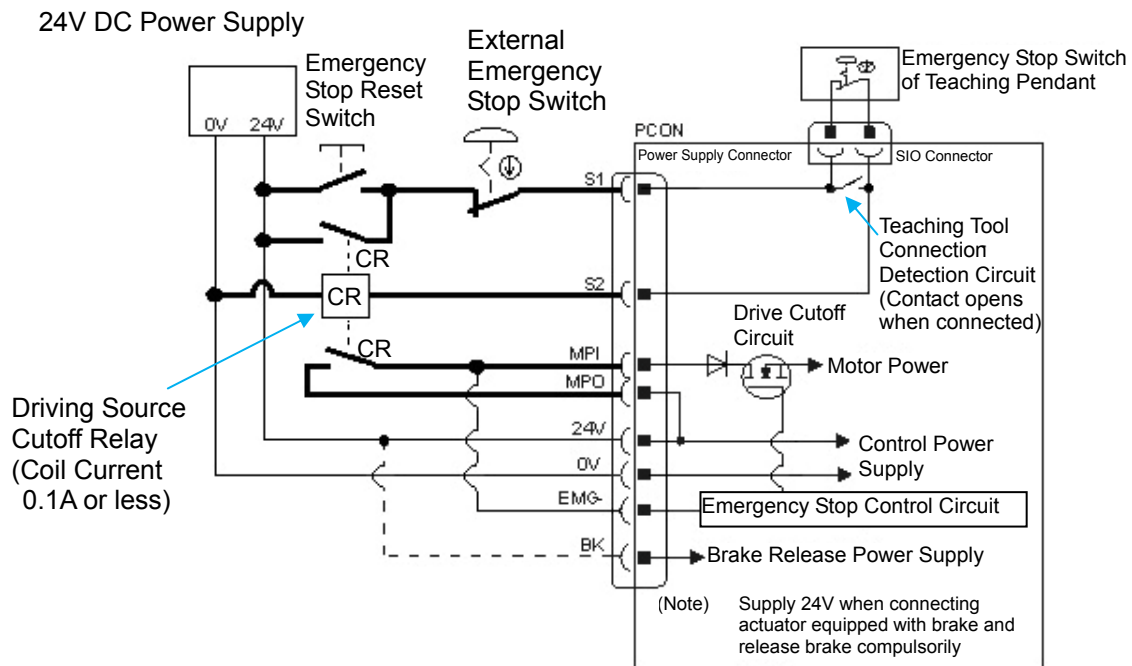

The emergency stop gets released when +24V is supplied to EMG- Terminal on the controller, and emergency stop activates if the power supply is shut, and stops the actuator operation, turns the servo OFF and cuts off the motor power supply inside the controller.

+24V supply to the external drive cutoff relay should get shut off when an external emergency stop switch or an emergency stop switch on the teaching pendant is turned ON. By this, the relay on the drive cutoff circuit opens and the power supply to the motor gets shut off. At the same time, +24V supply to EMG- terminal should also be shut off, and the condition should get into the emergency stop status.

Turn ON the emergency stop reset switch after putting the emergency stop switch back OFF, and +24V supply to the drive cutoff relay gets conducted. By this, the relay on the drive cutoff circuit closes and the power supply to the motor gets conducted. At the same time, +24V supply to EMG- terminal should also be resumed, and the emergency stop status should be cancelled.

Caution :

- When supplying the power by turning ON/OFF the 24V DC, keep the 0V being connected and have the +24V supplied/disconnected (cut one side only).
- The rating for the emergency stop signal (EMG-) is 24V DC and 10mA or less.
- Leave for 1 sec or more after shutting the power off before rebooting.
- Do not attempt to supply only the monitor power without supplying the control power.
- The safety categories complied type (CGB Type, etc.) is not equipped with the relay to have the controller automatically identify that a teaching tool was plugged in and switch the wiring layout. Those other than the safety categories complied type do the automatic identification.

- 4) Refer to below when shutting the motor power off externally by the emergency stop input when using two or more units of controllers.

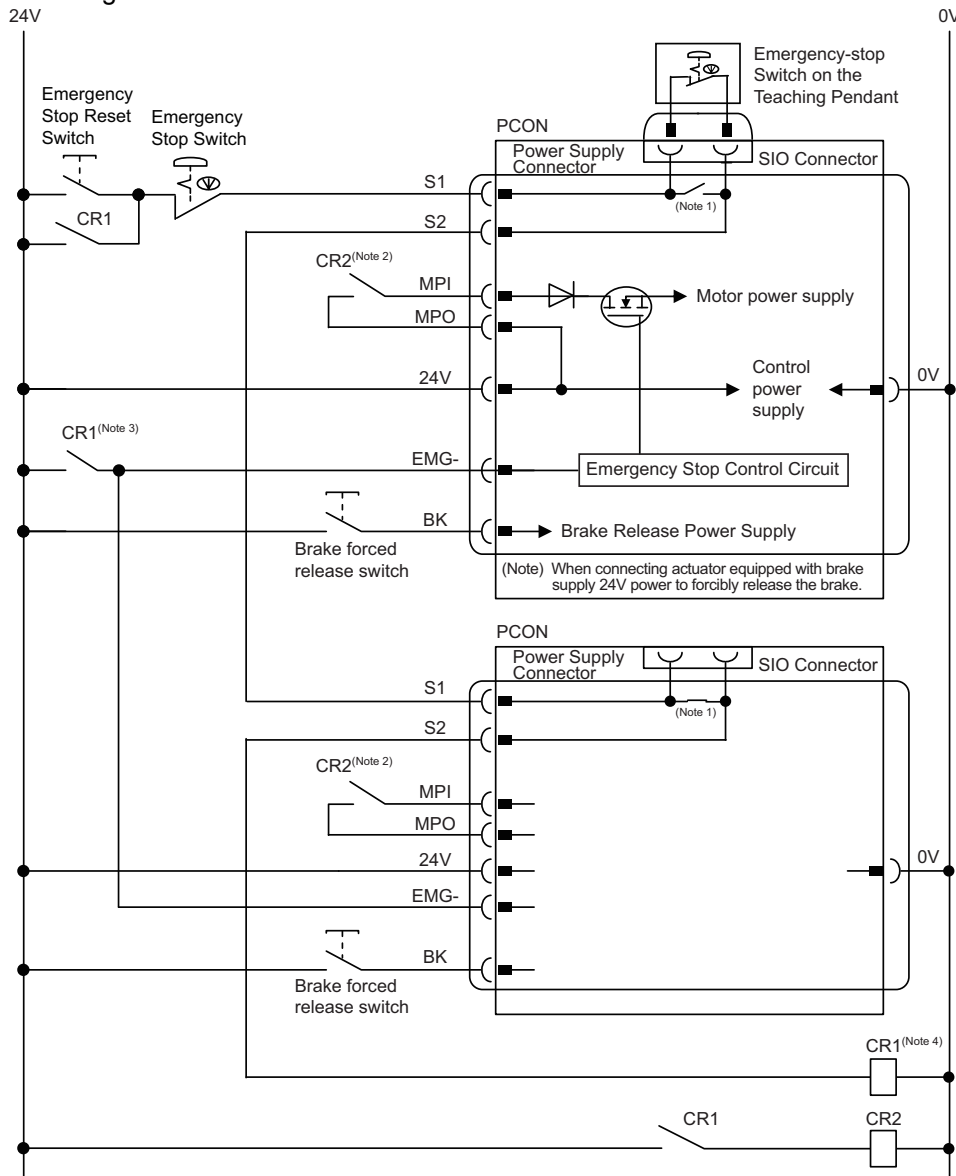

Note 1 : The safety categories complied type (CGB Type, etc.) is not equipped with the relay to have the controller automatically identify that a teaching tool was plugged in and switch the wiring layout. Those other than the safety categories complied type do the automatic identification and have S1 and S2 short-circuited.

Note 2 : When the motor driving source is cut off externally for a compliance with the safety category, connect a contact such as a contactor to the wires between MPI and MPO. [Refer to Chapter 9 Appendix]

Note 3 : The rating for the emergency stop signal (EMG-) to turn ON/OFF at contact CR1 is 24V DC and 10mA or less.

Note 4 : For CR1, select the one with coil current 0.1A or less.

(Note) : When rebooting after shutting down, leave for 1sec or more.

(Note) : Do not attempt to supply only the motor power without supplying the control power.

⚠ Caution : If supplying power with using a 24V DC, having it turned ON/OFF, keep the 0V connected and have the +24V supplied/disconnected (cut one side only).

[2] Motor • Encoder Circuit

1) Connection to RCP2 Series

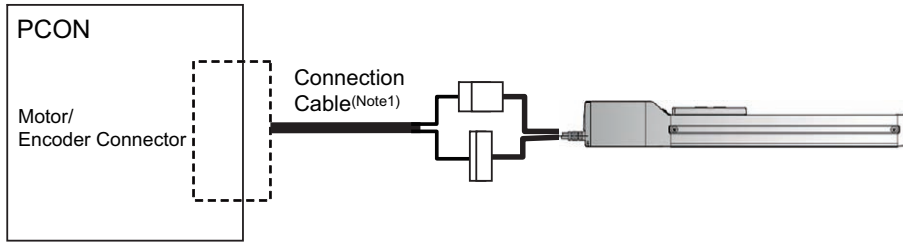

2) Connection to RCP3, RCP4, RCP5 and RCP6 Series

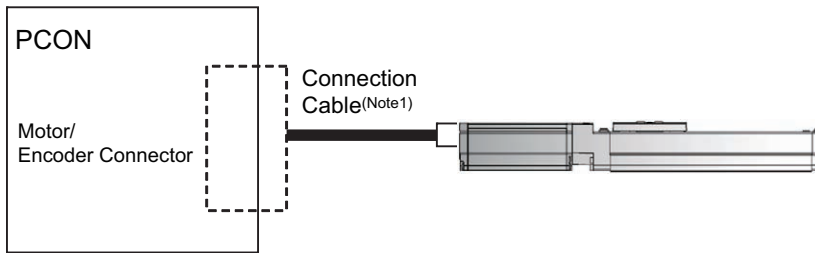

Note 1 Applicable Connection Cable Model Codes □□□ : Cable Length Example) 030 = 3m

Model Name	Cable	Reference
RCP2 (For CB type) Some excepted: Refer to catalog	CB-PSEP-MPA□□□	Robot cable from 0.5 to 20m
RCP3	CB-APSEP-MPA□□□	Robot cable from 0.5 to 20m
RCP4 (Except for GR* type) (For CB type)	CB-CA-MPA□□□-RB	Robot cable from 0.5 to 20m
	CB-CA-MPA□□□	Standard cable from 0.5 to 20m
RCP4 (GR* type), RCP5 (For CB type) RCP6 (For CB type)	CB-CAN-MPA□□□-RB	Robot cable from 0.5 to 20m
	CB-CAN-MPA□□□	Standard cable from 0.5 to 20m
RCP2-HS8, RA8, RA10, SA16 (High Thrust type)	CB-CFA-MPA□□□	Standard cable for High Thrust type from 0.5 to 20m
	CB-CFA-MPA□□□-RB	Robot cable for High Thrust type from 0.5 to 20m
RCP4-RA6 (56SP) RCP4W-RA7 (56SP) (High Thrust type)	CB-CFA2-MPA□□□	Standard cable for High Thrust type from 0.5 to 20m
	CB-CFA2-MPA□□□-RB	Robot cable for High Thrust type from 0.5 to 20m
RCP5-RA8, RA10 RCP6 (56SP, 60P) (High Thrust type)	CB-CFA3-MPA□□□	Standard cable for High Thrust type from 0.5 to 20m
	CB-CFA3-MPA□□□-RB	Robot cable for High Thrust type from 0.5 to 20m

[3] Absolute Circuit (For Simplified Absolute Type Only)

Connect to the absolute battery unit or absolute battery.

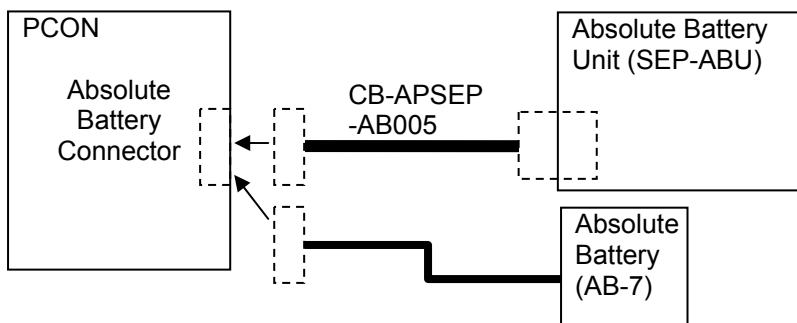

[4] PIO Circuit

1) PIO Pattern 0 Positioning Mode (Standard Type)

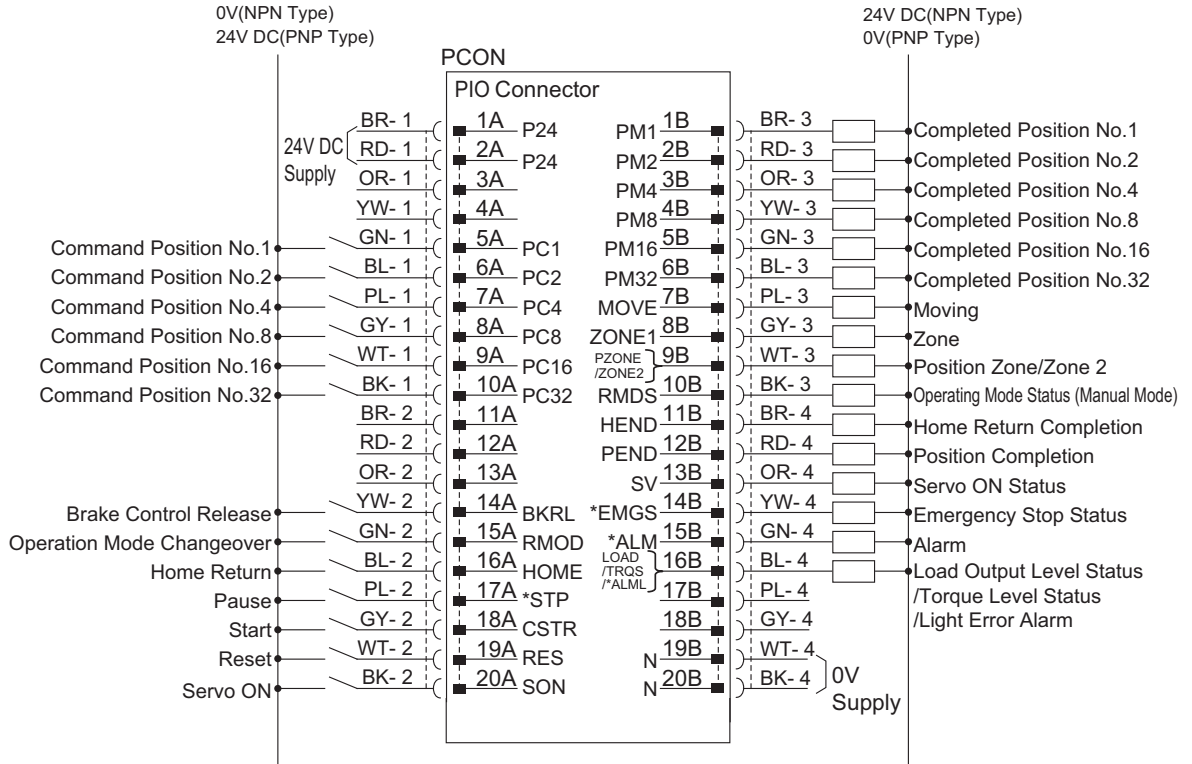

“*” in codes above shows the signal of the active low. Processing occurs when an input signal of the type is turned OFF. An output signal of the type is normally ON in the power-on status and turned OFF at signal output.

- Use the attached cable for the I/O connection.

Model : CB-PAC-PIO□□□ (□□□ indicates the cable length L. Example. 020 = 2m)

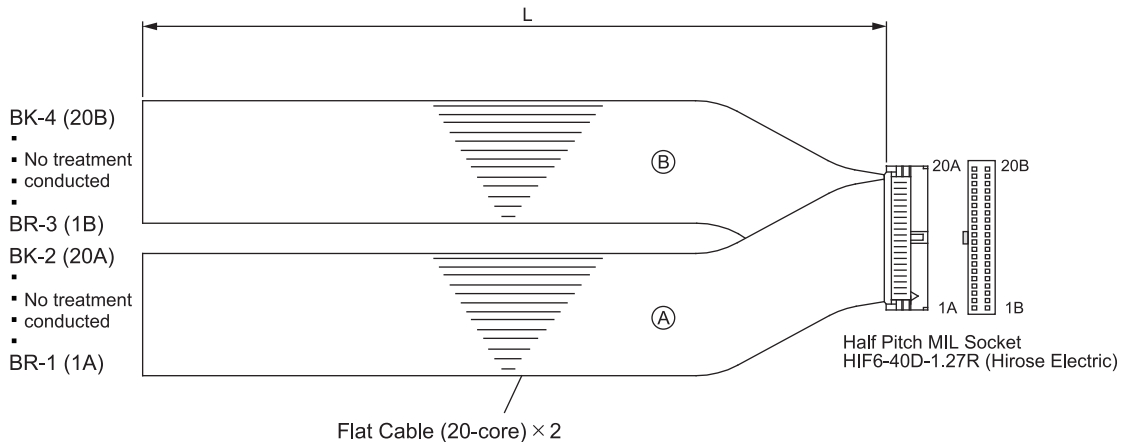

2) PIO Pattern 1 Teaching mode (Teaching type)

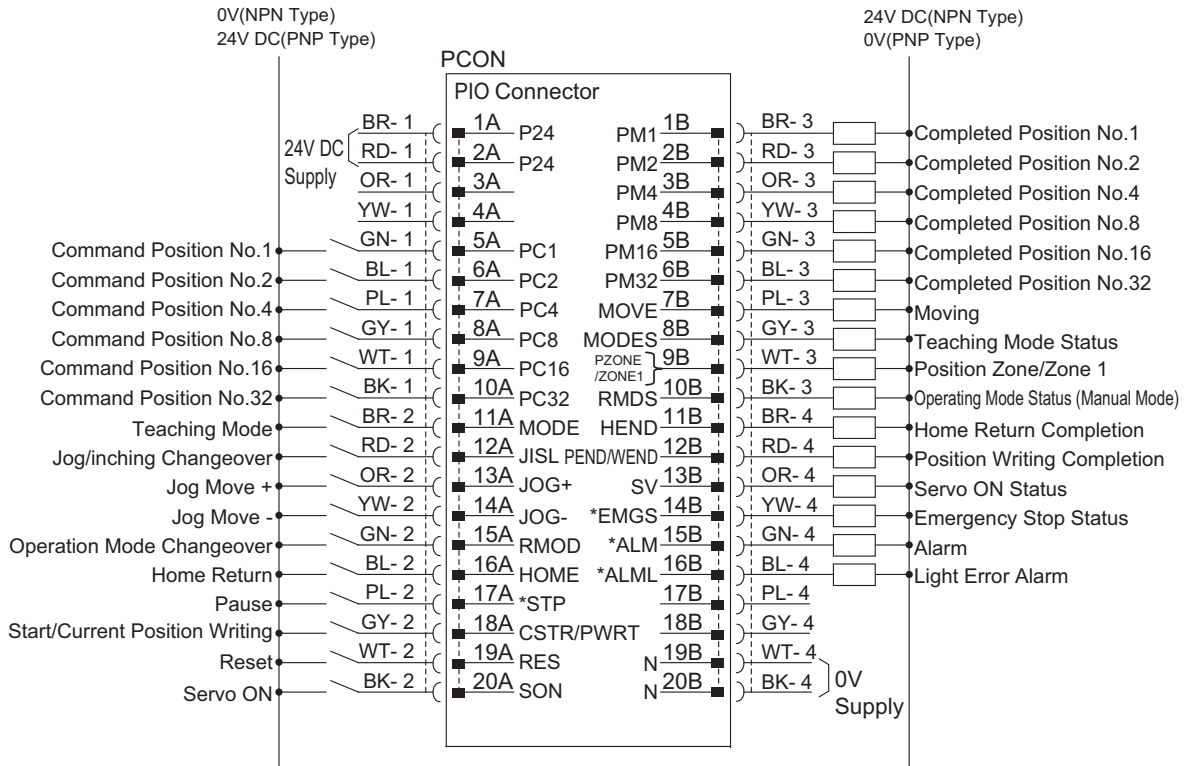

“*” in codes above shows the signal of the active low. Processing occurs when an input signal of the type is turned OFF. An output signal of the type is normally ON in the power-on status and turned OFF at signal output.

- Use the attached cable for the I/O connection.
Model : CB-PAC-PIO□□□ (□□□ indicates the cable length L. Example. 020 = 2m)

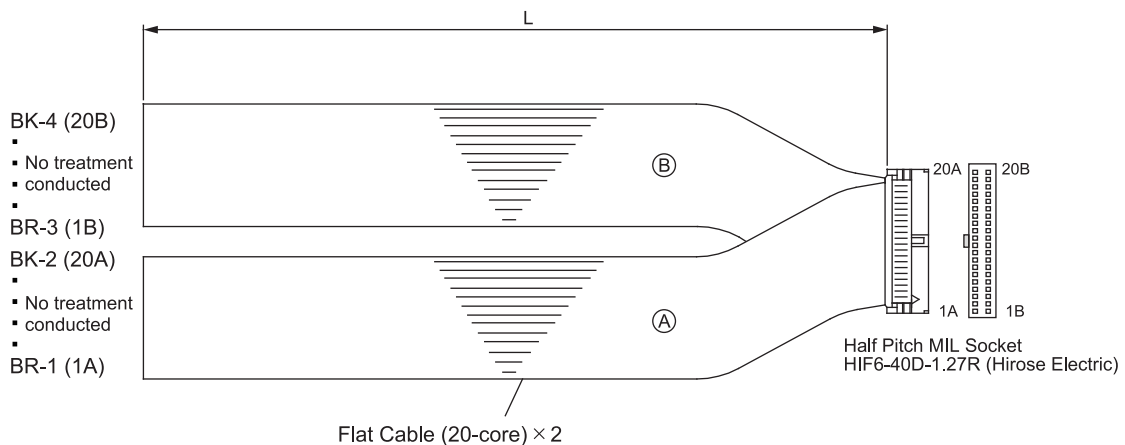

3) PIO Pattern 2 256-point mode (Number of positioning points : 256-point type)

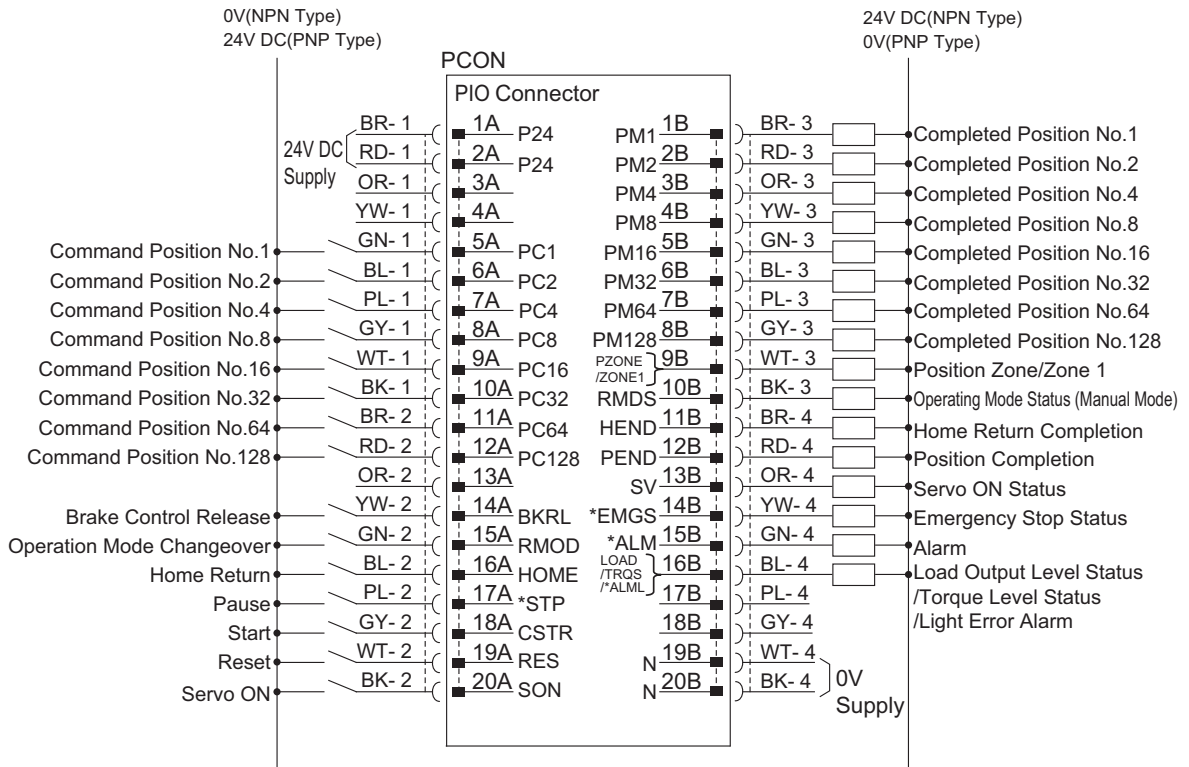

“*” in codes above shows the signal of the active low. Processing occurs when an input signal of the type is turned OFF. An output signal of the type is normally ON in the power-on status and turned OFF at signal output.

- Use the attached cable for the I/O connection.
Model : CB-PAC-PIO□□□ (□□□ indicates the cable length L. Example. 020 = 2m)

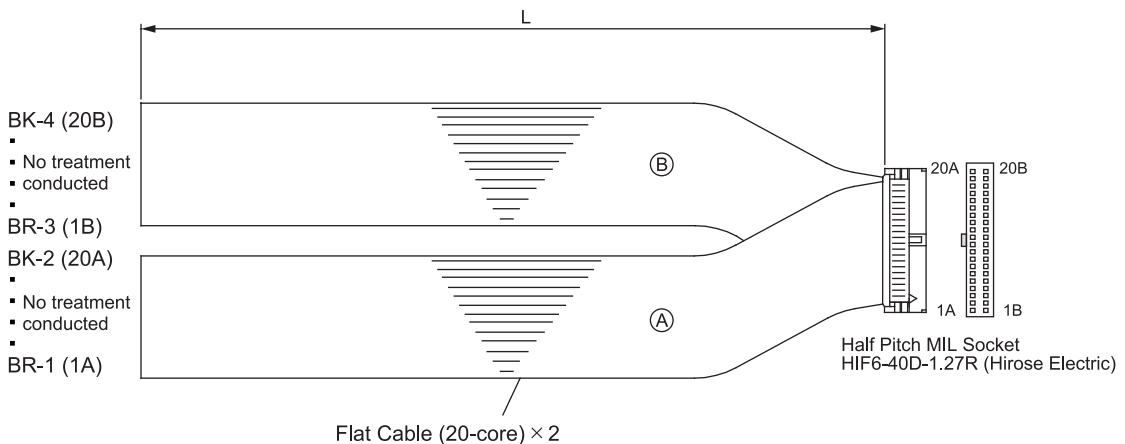

4) PIO Pattern 3 512-point mode (Number of positioning points : 512-point type)

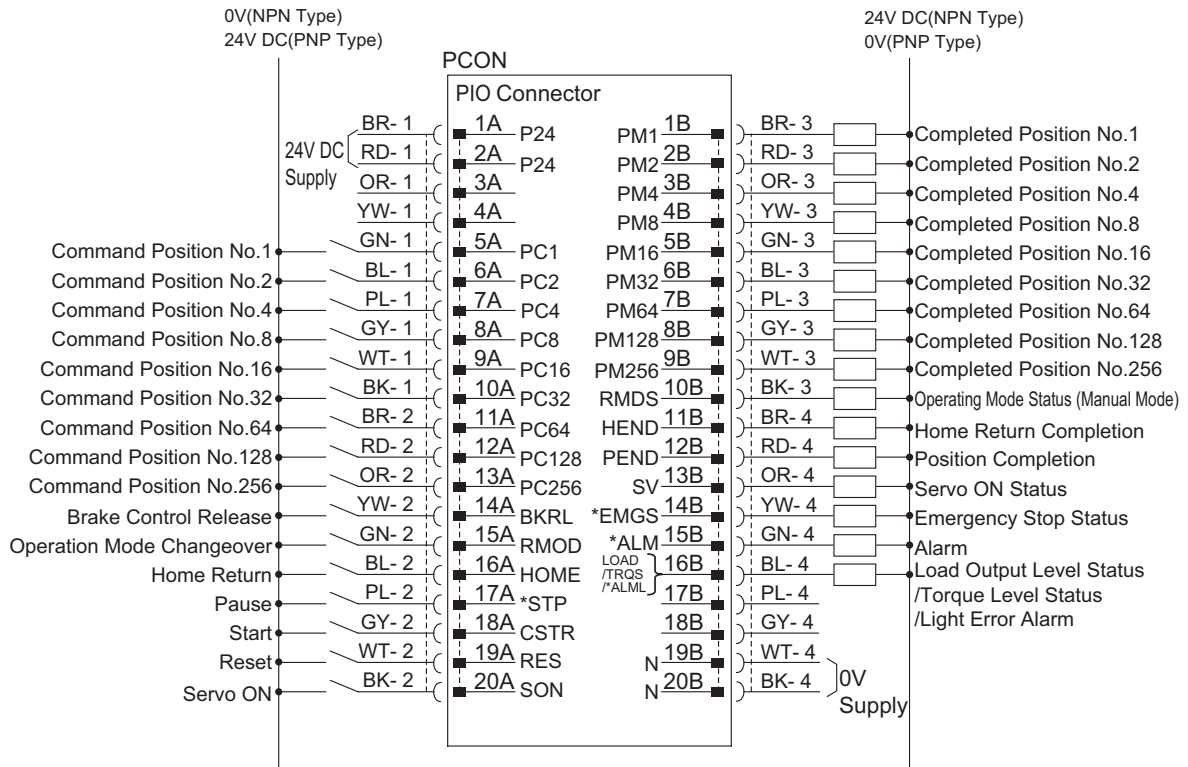

“*” in codes above shows the signal of the active low. Processing occurs when an input signal of the type is turned OFF. An output signal of the type is normally ON in the power-on status and turned OFF at signal output.

- Use the attached cable for the I/O connection.
Model : CB-PAC-PIO□□□ (□□□ indicates the cable length L. Example. 020 = 2m)

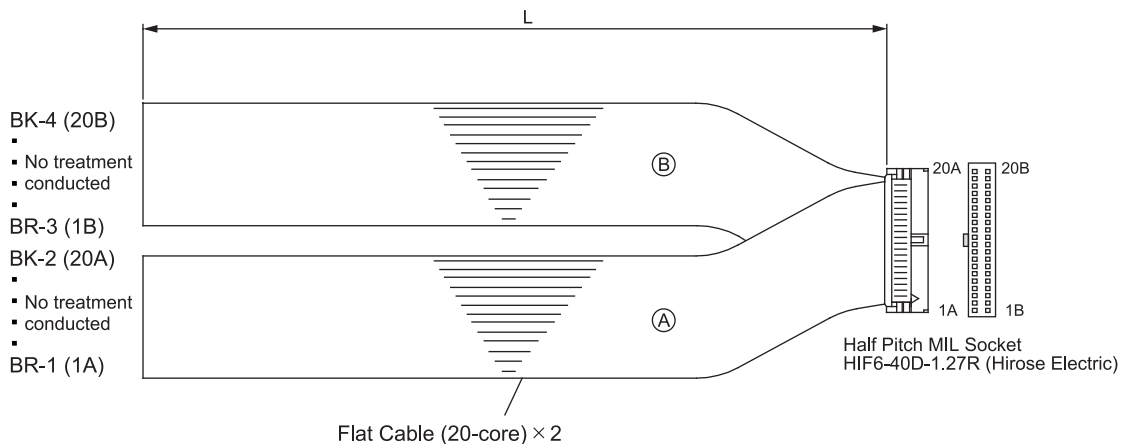

5) PIO Pattern 4 Solenoid Valve Mode 1 (7-point type)

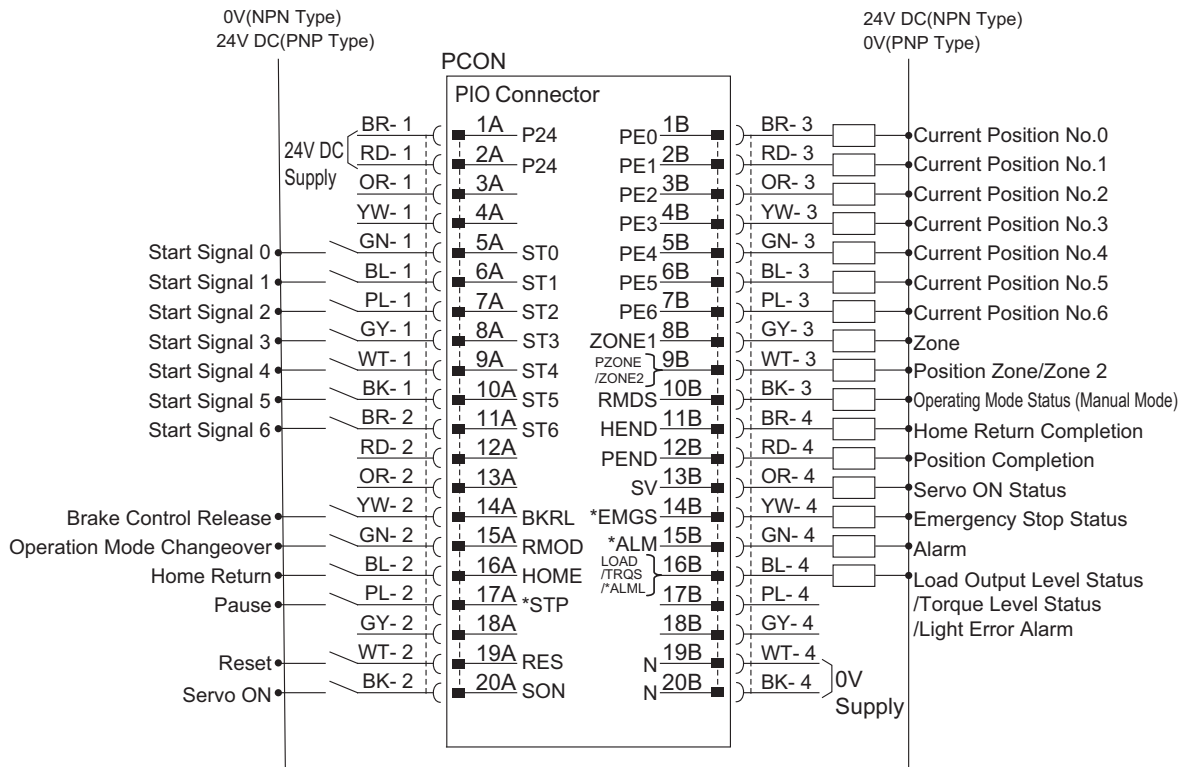

“*” in codes above shows the signal of the active low. Processing occurs when an input signal of the type is turned OFF. An output signal of the type is normally ON in the power-on status and turned OFF at signal output.

- Use the attached cable for the I/O connection.
Model : CB-PAC-PIO□□□ (□□□ indicates the cable length L. Example. 020 = 2m)

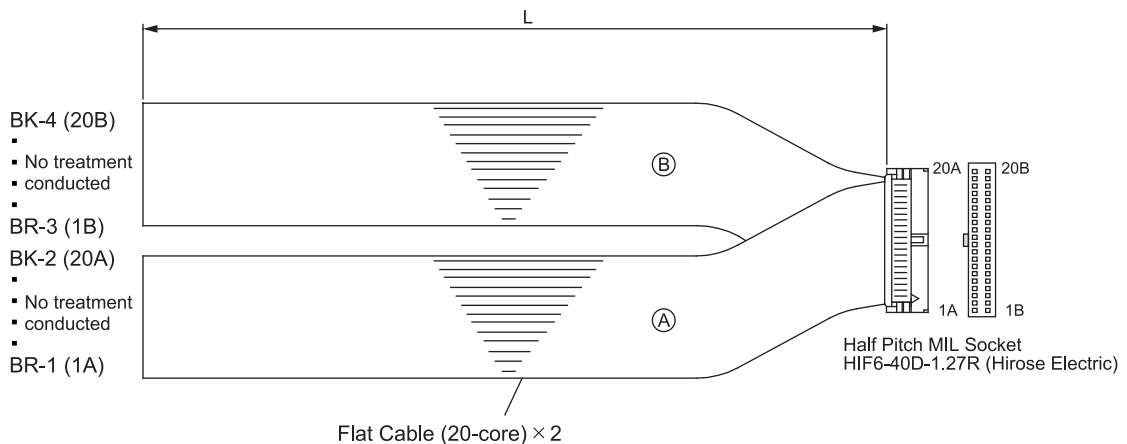

6) PIO Pattern 5 Solenoid Valve Mode 2 (3-point type)

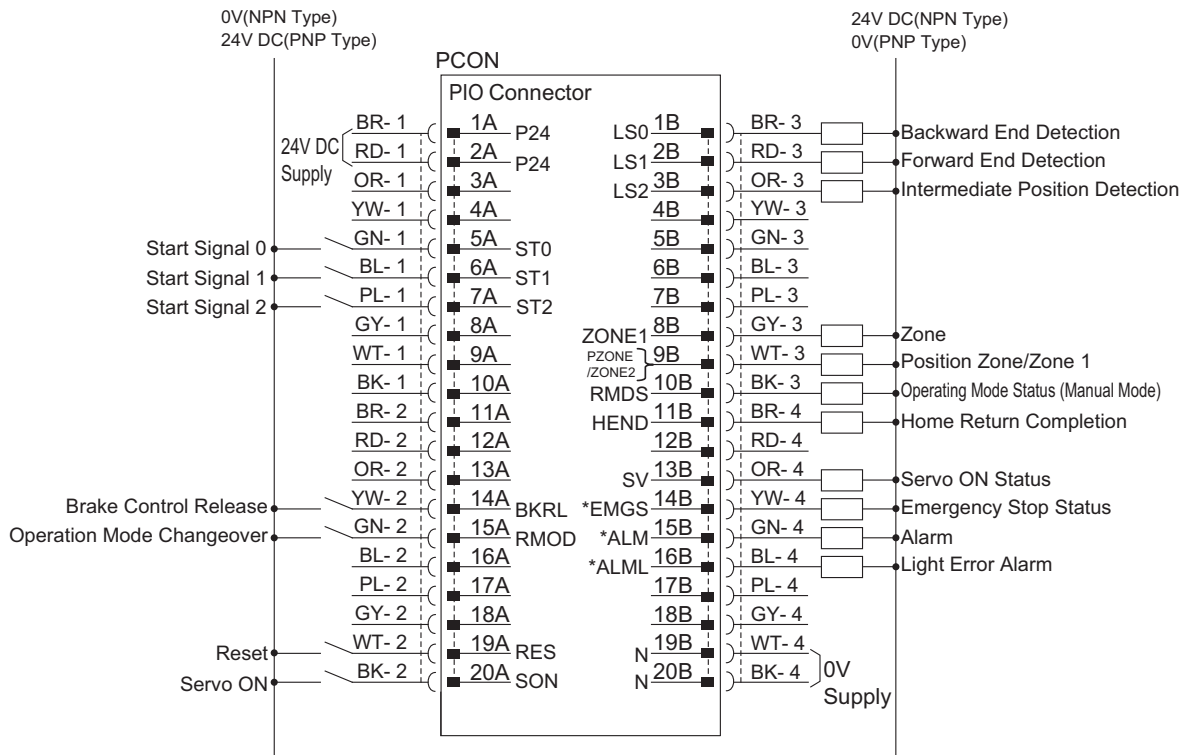

“*” in codes above shows the signal of the active low. Processing occurs when an input signal of the type is turned OFF. An output signal of the type is normally ON in the power-on status and turned OFF at signal output.

- Use the attached cable for the I/O connection.
Model : CB-PAC-PIO□□□ (□□□ indicates the cable length L. Example. 020 = 2m)

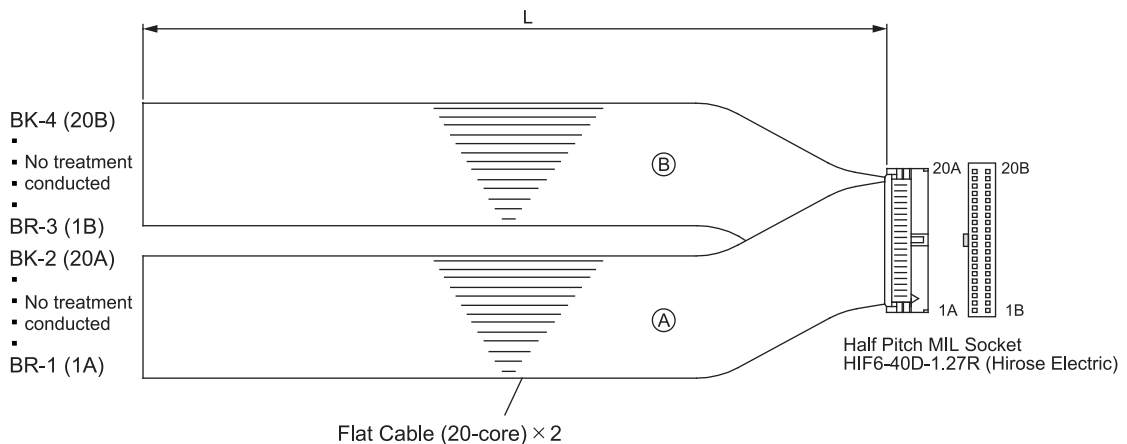

2.2 Pulse Train Control Mode

2.2.1 Wiring Diagram (Connection of Devices)

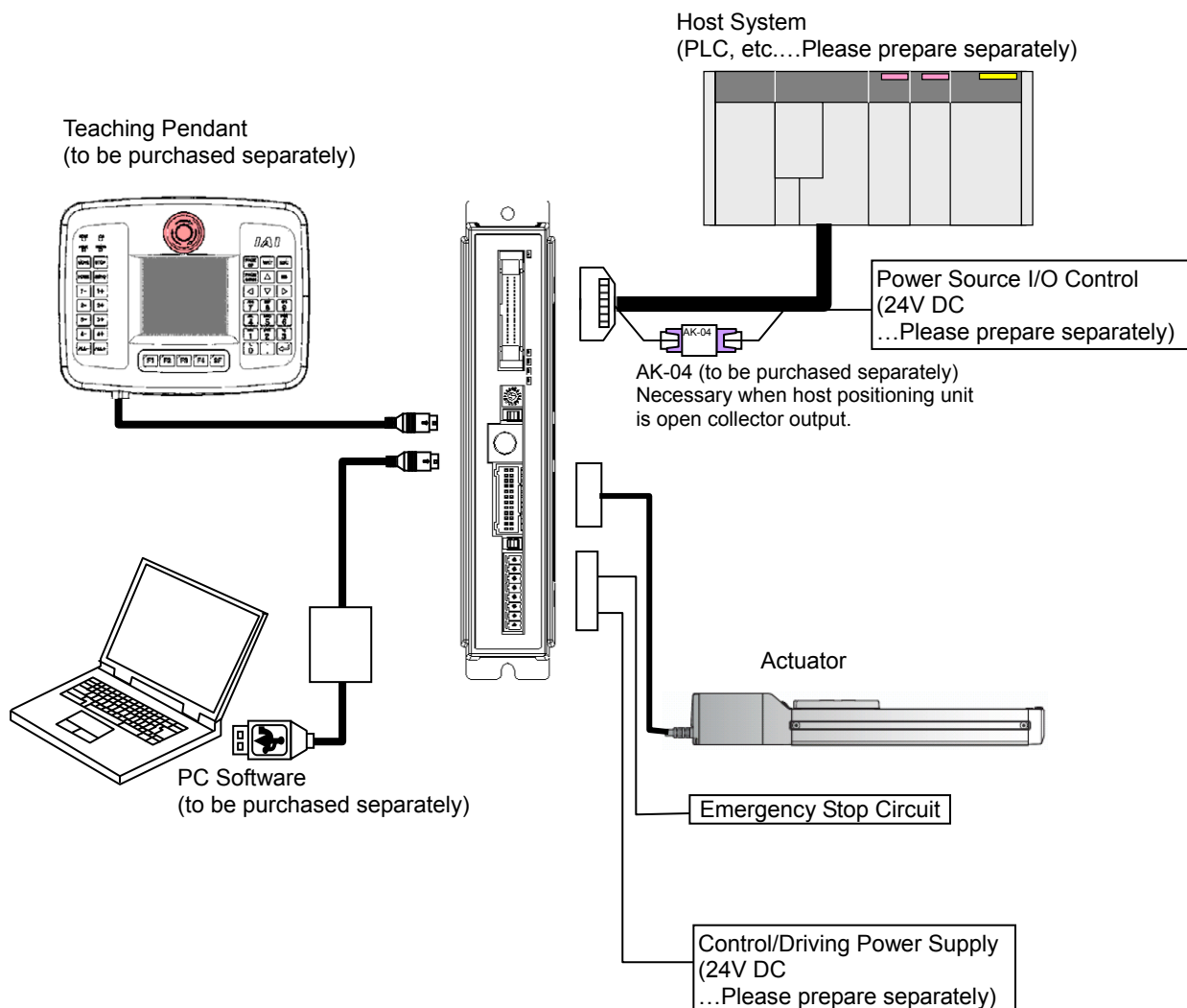

Caution : Make sure to turn the power to the controller OFF when inserting or removing the connector that connects the PC software or teaching pendant. Inserting or removing the connector while the power is turned ON causes a controller failure.

2.2.2 I/O Signals in Pulse Train Control Mode

[1] PIO Pattern 6 (Incremental Type for Actuator)

The table below shows the signal assignment of the flat cable in the “pulse train control mode” to PIO Pattern 6. Follow the following table to connect the external equipment (such as host unit).

Pin No.	Category	I/O No.	Signal Abbreviation	Signal Name	Function Description	Relevant Sections
1A	24V		P24	Power Supply	Power Supply for I/O +24V	
2A	24V		P24	Power Supply	Power Supply for I/O +24V	
3A	Pulse Input		PP	Differential Pulse Train Input (+)	Input the differential pulse from the host. Input is available up to 200kpps at maximum.	2.2.3 [4] 3.3.3 [1]
4A			/PP	Differential Pulse Train Input (-)		
5A	Input	IN0	SON	Servo ON	The servo remains ON while this signal is ON, or OFF while this signal is OFF.	3.3.2 [5]
6A		IN1	RES	Reset	Turn the signal ON to reset the alarm.	3.3.2 [9]
7A		IN2	HOME	Home Return	The controller will perform home return operation when this signal is turned ON.	3.3.2 [6]
8A		IN3	TL	Torque Limit Select	Applies torque limit to the motor with the signal ON and the value set to the parameter.	3.3.3 [3]
9A		IN4	CSTP	Compulsory Stop	Turning it ON continuously for more than 16ms forcibly stops the actuator. The actuator decelerates then stops with the torque set in the controller and then turns the servo OFF.	3.3.2 [4]
10A		IN5	DCLR	Deviation Counter Clear	Clears the deviation counter.	3.3.3 [4]
11A		IN6	BKRL	Brake Release	The brake will forcibly be released.	3.3.2 [11]
12A		IN7	RMOD	Operation Mode Changeover	The operating mode is selectable when the MODE switch of the controller is set to AUTO. (The setting is AUTO when signal is OFF, and MANU when ON.)	3.3.2 [3]
13A		IN8	NC	-	Not used	
14A		IN9	NC	-	Not used	
15A		IN10	NC	-	Not used	
16A		IN11	NC	-	Not used	
17A		IN12	NC	-	Not used	
18A		IN13	NC	-	Not used	
19A		IN14	NC	-	Not used	
20A	IN15	NC	-	Not used		
1B	Output	OUT0	PWR	System Ready	It turns ON when the control becomes available after the main power is supplied.	3.3.2 [1]
2B		OUT1	SV	Servo ON Status	This signal will remain ON while the servo is ON.	3.3.2 [5]
3B		OUT2	INP	Position Complete	Turned ON when the remaining moving pulses in the deviation counter enters within the positioning band.	3.3.3 [2]
4B		OUT3	HEND	Home return completion	This signal will turn ON when home return has been completed.	3.3.2 [6]
5B		OUT4	TLR	Torque Under Control	Turns ON if the torque reaches the limit value during torque limit.	3.3.3 [3]
6B		OUT5	*ALM	Controller Alarm Status	Turns ON when controller in normal condition, and OFF when alarm is generated.	3.3.2 [9]
7B		OUT6	*EMGS	Emergency Stop Status	Turns ON when the controller emergency stop is cancelled, and OFF during the emergency stop.	3.3.2 [2]
8B		OUT7	RMDS	Operation Mode Status	The operating mode status will be output. It turns ON when the controller is on Manual Mode.	3.3.2 [3]
9B		OUT8	ALM1	Alarm Code Output Signal	The alarm code is output together with the alarm signal output. Refer to Alarm List for details.	3.3.2 [10]
10B		OUT9	ALM2			
11B		OUT10	ALM4			
12B		OUT11	ALM8			
13B		OUT12	*ALML	Light Error Alarm	Outputs when a message level alarm is generated.	8.4
14B		OUT13	NC	-	Not used	
15B		OUT14	ZONE1	Zone Signal 1	This signal will turn ON when the current actuator position enters the range set by the parameters.	3.3.2 [8]
16B	OUT15	ZONE2	Zone Signal 2			
17B	Pulse Input		NP	Differential Pulse Train Input (+)	Input the differential pulse from the host. Input is available up to 200kpps at maximum.	2.2.3 [4] 3.3.3 [1]
18B			/NP	Differential Pulse Train Input (-)		
19B	0V		N	Power Supply	Power Supply for I/O 0V	
20B	0V		N	Power Supply	Power Supply for I/O 0V	

Signal with “*” expresses the signal of active low. It is ON when the power is applied to the controller, and turns OFF when the signal is output.

[2] PIO Pattern 7 (Incremental Type for Actuator)

The table below shows the signal assignment of the flat cable in the “pulse train control mode” to PIO Pattern 6. Follow the following table to connect the external equipment (such as host unit).

Pin No.	Category	I/O No.	Signal Abbreviation	Signal Name	Function Description	Relevant Sections
1A	24V		P24	Power Supply	Power Supply for I/O +24V	
2A	24V		P24	Power Supply	Power Supply for I/O +24V	
3A	Pulse Input		PP	Differential Pulse Train Input (+)	Input the differential pulse from the host. Input is available up to 200kpps at maximum.	2.2.3 [4] 3.3.3 [1]
4A			/PP	Differential Pulse Train Input (-)		
5A	Input	IN0	SON	Servo ON	The servo remains ON while this signal is ON, or OFF while this signal is OFF.	3.3.2 [5]
6A		IN1	RES	Reset	Turn the signal ON to reset the alarm.	3.3.2 [10]
7A		IN2	HOME	Home Return	The controller will perform home return operation when this signal is turned ON.	3.3.2 [6]
8A		IN3	TL	Torque Limit Select	Applies torque limit to the motor with the signal ON and the value set to the parameter.	3.3.3 [3]
9A		IN4	CSTP	Compulsory Stop	Turning it ON continuously for more than 16ms forcibly stops the actuator. The actuator decelerates then stops with the torque set in the controller and then turns the servo OFF.	3.3.2 [4]
10A		IN5	DCLR	Deviation Counter Clear	Clears the deviation counter.	3.3.3 [4]
11A		IN6	BKRL	Brake Release	The brake will forcibly be released.	3.3.2 [11]
12A		IN7	RMOD	Operation Mode Changeover	The operating mode is selectable when the MODE switch of the controller is set to AUTO. (The setting is AUTO when signal is OFF, and MANU when ON.)	3.3.2 [3]
13A		IN8	RSTR	Datum Position Movement Command	Applies torque limit to the motor with the signal ON and the value set to the parameter No.167	3.3.2 [8]
14A		IN9	NC	-	Not used	
15A		IN10	NC	-	Not used	
16A		IN11	NC	-	Not used	
17A		IN12	NC	-	Not used	
18A		IN13	NC	-	Not used	
19A		IN14	NC	-	Not used	
20A	IN15	NC	-	Not used		
1B	Output	OUT0	PWR	System Ready	It turns ON when the control becomes available after the main power is supplied.	3.3.2 [1]
2B		OUT1	SV	Servo ON Status	This signal will remain ON while the servo is ON.	3.3.2 [5]
3B		OUT2	INP	Position Complete	Turned ON when the remaining moving pulses in the deviation counter enters within the positioning band.	3.3.3 [2]
4B		OUT3	HEND	Home return completion	This signal will turn ON when home return has been completed.	3.3.2 [6]
5B		OUT4	TLR	Torque Under Control	Turns ON if the torque reaches the limit value during torque limit.	3.3.3 [3]
6B		OUT5	*ALM	Controller Alarm Status	Turns ON when controller in normal condition, and OFF when alarm is generated.	3.3.2 [10]
7B		OUT6	*EMGS	Emergency Stop Status	Turns ON when the controller emergency stop is cancelled, and OFF during the emergency stop.	3.3.2 [2]
8B		OUT7	RMDS	Operation Mode Status	The operating mode status will be output. It turns ON when the controller is on Manual Mode.	3.3.2 [3]
9B		OUT8	ALM1	Alarm Code Output Signal	The alarm code is output together with the alarm signal output. Refer to Alarm List for details.	3.3.2 [11]
10B		OUT9	ALM2			
11B		OUT10	ALM4			
12B		OUT11	ALM8			
13B		OUT12	*ALML	Light Error Alarm	Outputs when a message level alarm is generated.	8.4
14B		OUT13	REND	Datum Position Movement Complete	Turns on when movement to the datum position set in Parameter No.167 is finished.	3.3.2 [8]
15B		OUT14	ZONE1	Zone Signal 1	This signal will turn ON when the current actuator position enters the range set by the parameters.	3.3.2 [9]
16B	OUT15	ZONE2	Zone Signal 2			
17B	Pulse Input		NP	Differential Pulse Train Input (+)	Input the differential pulse from the host. Input is available up to 200kpps at maximum.	2.2.3 [4] 3.3.3 [1]
18B			/NP	Differential Pulse Train Input (-)		
19B	0V		N	Power Supply	Power Supply for I/O 0V	
20B	0V		N	Power Supply	Power Supply for I/O 0V	

Signal with “*” expresses the signal of active low. It is ON when the power is applied to the controller, and turns OFF when the signal is output.

2.2.3 Wiring

[1] Power Supply Connector (for Power Supply and Emergency Stop)

As an example of a circuit, cases of 4 conditions are shown. Select from 3) or 4) for CGB type.

- 1) Operate actuator without using the emergency stop input (EMG-)
- 2) Operate actuator with the emergency stop input (EMG-) activated
- 3) Stop supplying external motor power at emergency stop input
- 4) Shut off the motor power externally by inputting the emergency stop with using two units of controllers or more.

1) Operate actuator without using the emergency stop input (EMG-)

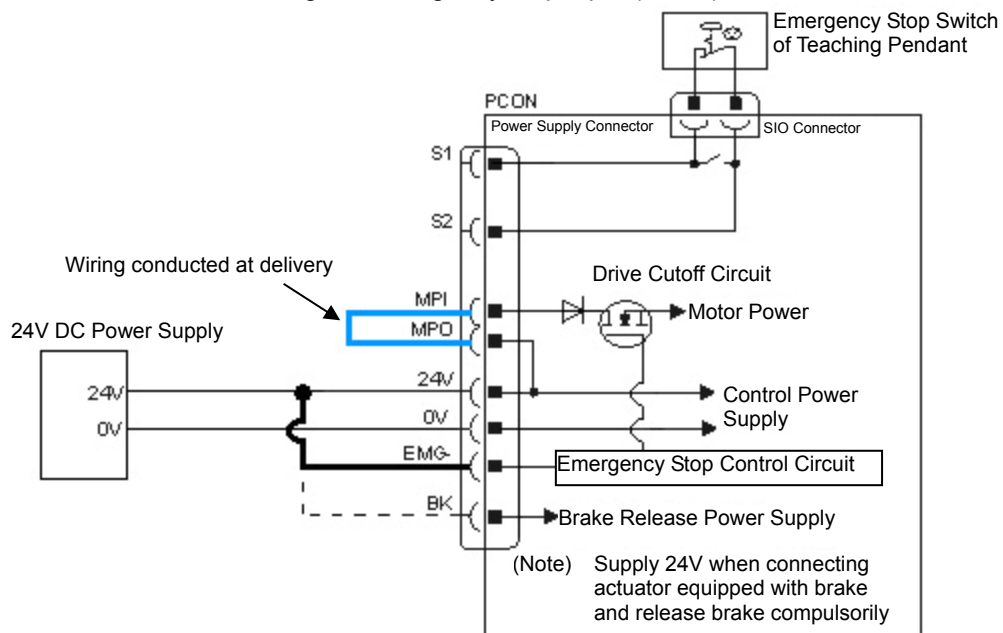

The emergency stop to the controller gets inactivated by supplying +24V continuously to EMG- Terminal. The emergency stop switch on the teaching pendant should be inactivated when S1 and S2 are not wired.

• Image of Wiring

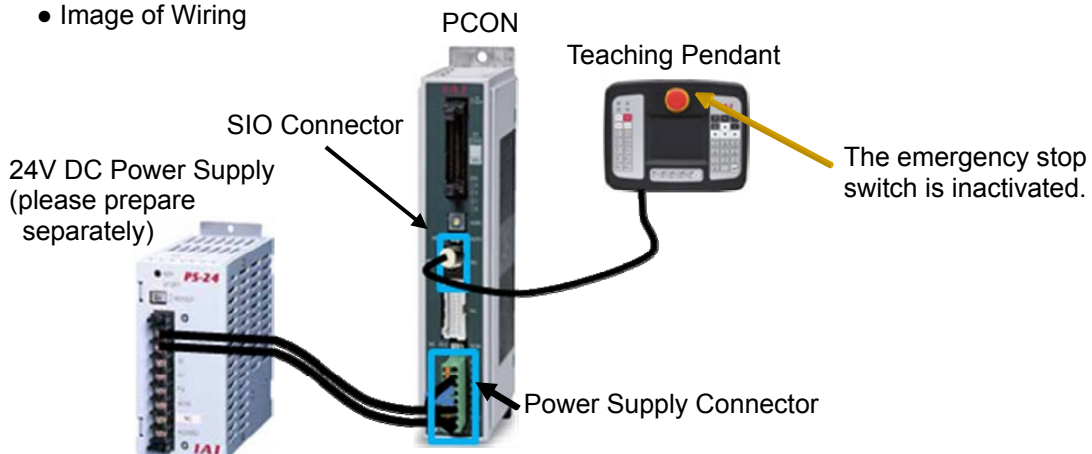

⚠ Caution ∴ When supplying the power by turning ON/OFF the 24V DC, keep the 0V being connected and have the +24V supplied/disconnected (cut one side only).

- The rating for the emergency stop signal (EMG-) is 24V DC and 10mA or less.
- Leave for 1 sec or more after shutting the power off before rebooting.
- Do not attempt to supply only the monitor power without supplying the control power.

2) Example for wiring to operate actuator with the emergency stop input (EMG-) activated

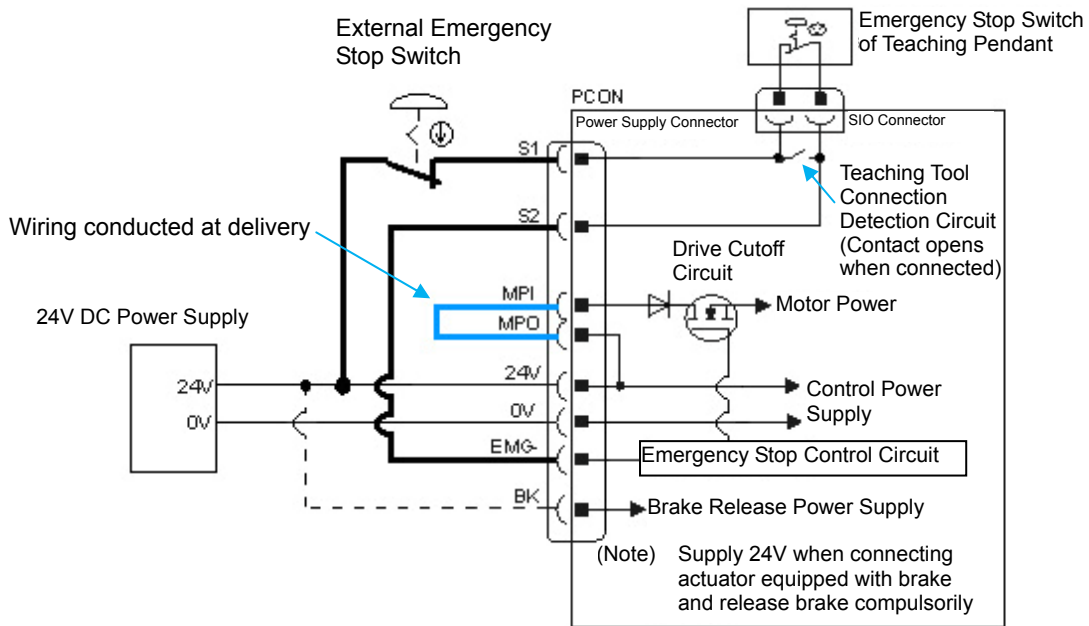

The emergency stop gets released when +24V is supplied to EMG- Terminal on the controller, and emergency stop activates if the power supply is shut, and stops the actuator operation, turns the servo OFF and cuts off the motor power supply inside the controller. Have an external emergency stop switch connected, and connect +24V to EMG- Terminal via the emergency stop switch ON the teaching pendant. +24V supply to EMG- terminal should get shut off when an external emergency stop switch or an emergency stop switch on the teaching pendant is turned ON, and the condition should get into the emergency stop status.

• Image of Wiring

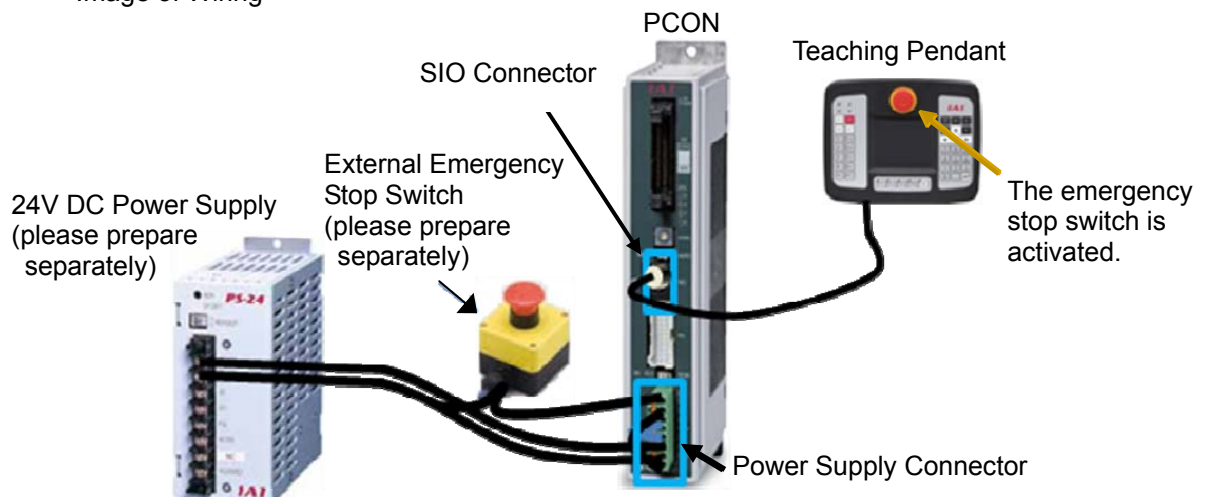

Caution :: When supplying the power by turning ON/OFF the 24V DC, keep the 0V being connected and have the +24V supplied/disconnected (cut one side only).
 · The rating for the emergency stop signal (EMG-) is 24V DC and 10mA or less.
 · Leave for 1 sec or more after shutting the power off before rebooting.
 · Do not attempt to supply only the monitor power without supplying the control power.

3) Example for wiring to stop supplying external motor power at emergency stop input

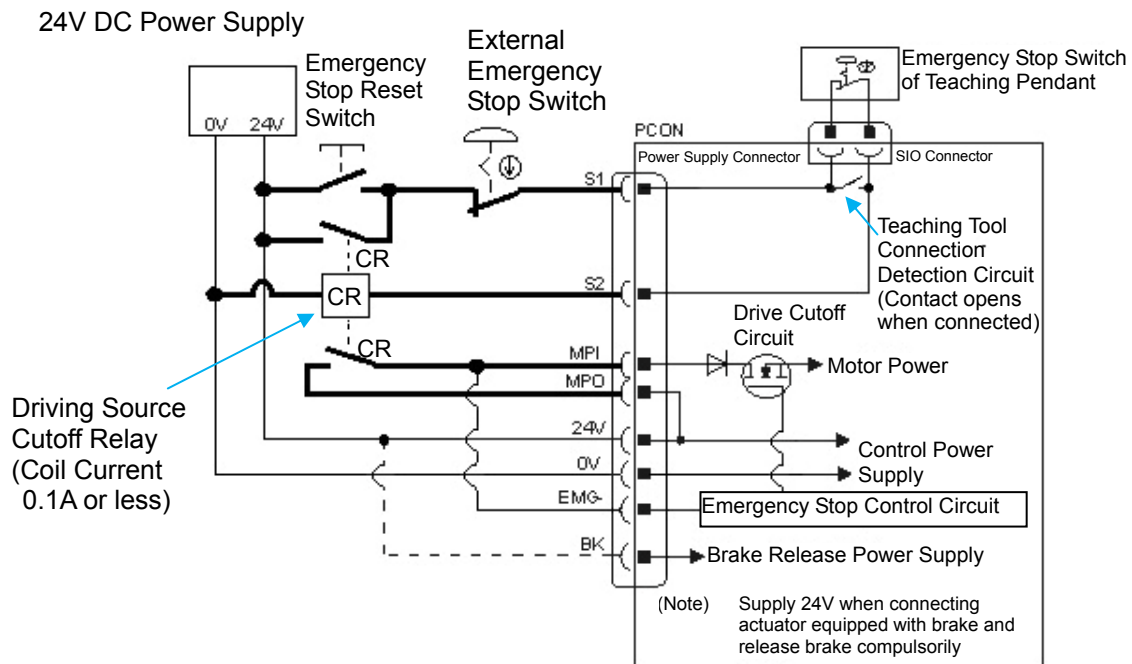

The emergency stop gets released when +24V is supplied to EMG- Terminal on the controller, and emergency stop activates if the power supply is shut, and stops the actuator operation, turns the servo OFF and cuts off the motor power supply inside the controller.

+24V supply to the external drive cutoff relay should get shut off when an external emergency stop switch or an emergency stop switch on the teaching pendant is turned ON. By this, the relay on the drive cutoff circuit opens and the power supply to the motor gets shut off. At the same time, +24V supply to EMG- terminal should also be shut off, and the condition should get into the emergency stop status.

Turn ON the emergency stop reset switch after putting the emergency stop switch back OFF, and +24V supply to the drive cutoff relay gets conducted. By this, the relay on the drive cutoff circuit closes and the power supply to the motor gets conducted. At the same time, +24V supply to EMG- terminal should also be resumed, and the emergency stop status should be cancelled.

Caution :

- When supplying the power by turning ON/OFF the 24V DC, keep the 0V being connected and have the +24V supplied/disconnected (cut one side only).
- The rating for the emergency stop signal (EMG-) is 24V DC and 10mA or less.
- Leave for 1 sec or more after shutting the power off before rebooting.
- Do not attempt to supply only the monitor power without supplying the control power.
- The safety categories complied type (CGB Type, etc.) is not equipped with the relay to have the controller automatically identify that a teaching tool was plugged in and switch the wiring layout. Those other than the safety categories complied type do the automatic identification.

- 4) Refer to below when shutting the motor power off externally by the emergency stop input when using two or more units of controllers.

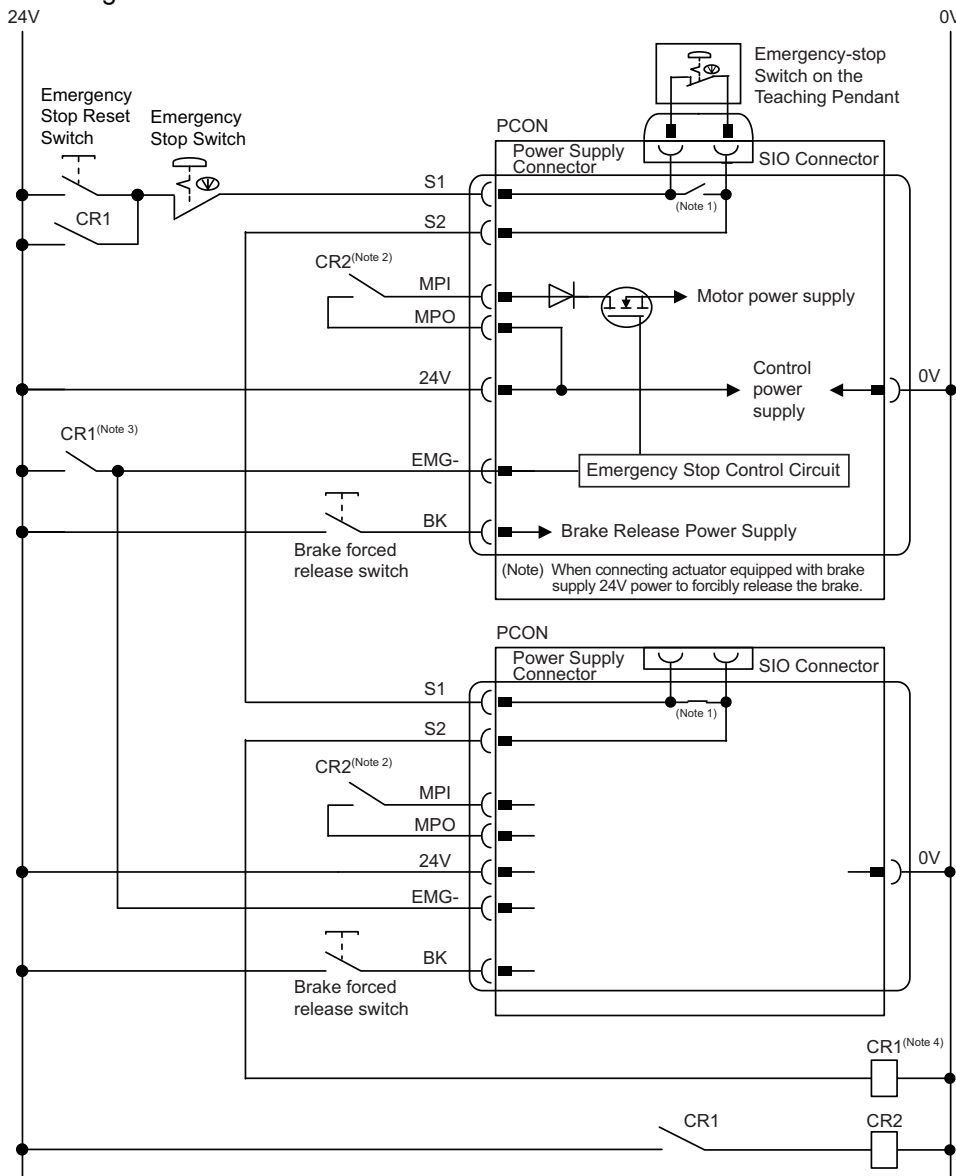

Note 1 : The safety categories complied type (CGB Type, etc.) is not equipped with the relay to have the controller automatically identify that a teaching tool was plugged in and switch the wiring layout. Those other than the safety categories complied type do the automatic identification and have S1 and S2 short-circuited.

Note 2 : When the motor driving source is cut off externally for a compliance with the safety category, connect a contact such as a contactor to the wires between MPI and MPO. [Refer to Chapter 9 Appendix]

Note 3 : The rating for the emergency stop signal (EMG-) to turn ON/OFF at contact CR1 is 24V DC and 10mA or less.

Note 4 : For CR1, select the one with coil current 0.1A or less.

(Note) : When rebooting after shutting down, leave for 1sec or more.

(Note) : Do not attempt to supply only the motor power without supplying the control power.

Caution : If supplying power with using a 24V DC, having it turned ON/OFF, keep the 0V connected and have the +24V supplied/disconnected (cut one side only).

[2] Motor • Encoder Circuit

1) Connection to RCP2 Series

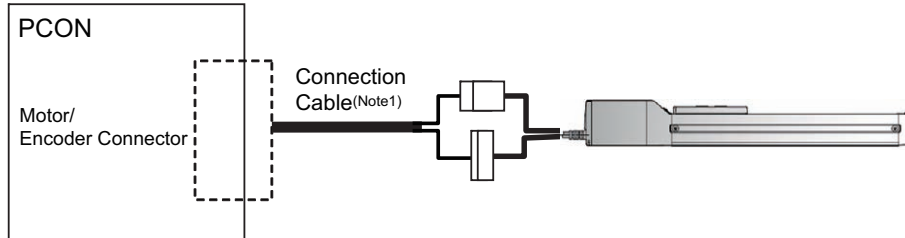

2) Connection to RCP3, RCP4, RCP5 and RCP6 Series

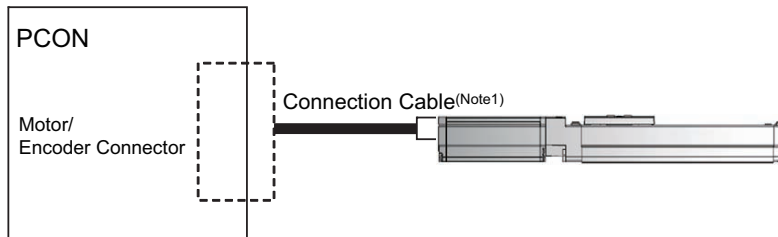

Note 1 Applicable Connection Cable Model Codes □□□ : Cable Length Example) 030 = 3m

Model Name	Cable	Reference
RCP2 (For CB type) Some excepted: Refer to catalog	CB-PSEP-MPA□□□	Robot cable from 0.5 to 20m
RCP3	CB-APSEP-MPA□□□	Robot cable from 0.5 to 20m
RCP4 (Except for GR* type) (For CB type)	CB-CA-MPA□□□-RB	Robot cable from 0.5 to 20m
	CB-CA-MPA□□□	Standard cable from 0.5 to 20m
RCP4 (GR* type), RCP5 (For CB type) RCP6 (For CB type)	CB-CAN-MPA□□□-RB	Robot cable from 0.5 to 20m
	CB-CAN-MPA□□□	Standard cable from 0.5 to 20m
RCP2-HS8, RA8, RA10, SA16 (High Thrust type)	CB-CFA-MPA□□□	Standard cable for High Thrust type from 0.5 to 20m
	CB-CFA-MPA□□□-RB	Robot cable for High Thrust type from 0.5 to 20m
RCP4-RA6 (56SP) RCP4W-RA7 (56SP) (High Thrust type)	CB-CFA2-MPA□□□	Standard cable for High Thrust type from 0.5 to 20m
	CB-CFA2-MPA□□□-RB	Robot cable for High Thrust type from 0.5 to 20m
RCP5-RA8, RA10 RCP6 (56SP, 60P) (High Thrust type)	CB-CFA3-MPA□□□	Standard cable for High Thrust type from 0.5 to 20m
	CB-CFA3-MPA□□□-RB	Robot cable for High Thrust type from 0.5 to 20m

[3] PIO Circuit

1) PIO Pattern 6..... Pulse Train Control Mode (Incremental Type for Actuator)

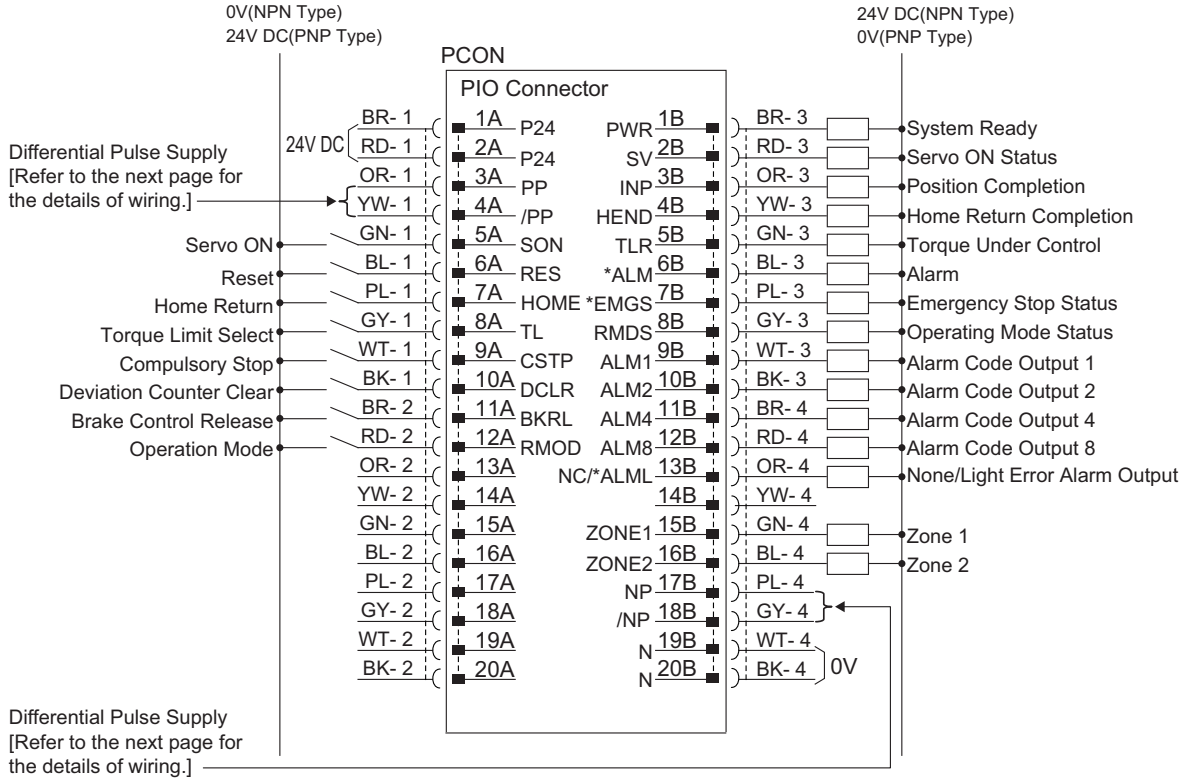

“**” in codes above shows the signal of the active low. Processing occurs when an input signal of the type is turned OFF. An output signal of the type is normally ON in the power-on status and turned OFF at signal output.

- Use the attached cable for the I/O connection.

Model : CB-PAC-PIO□□□ (□□□ indicates the cable length L. Example. 020 = 2m)

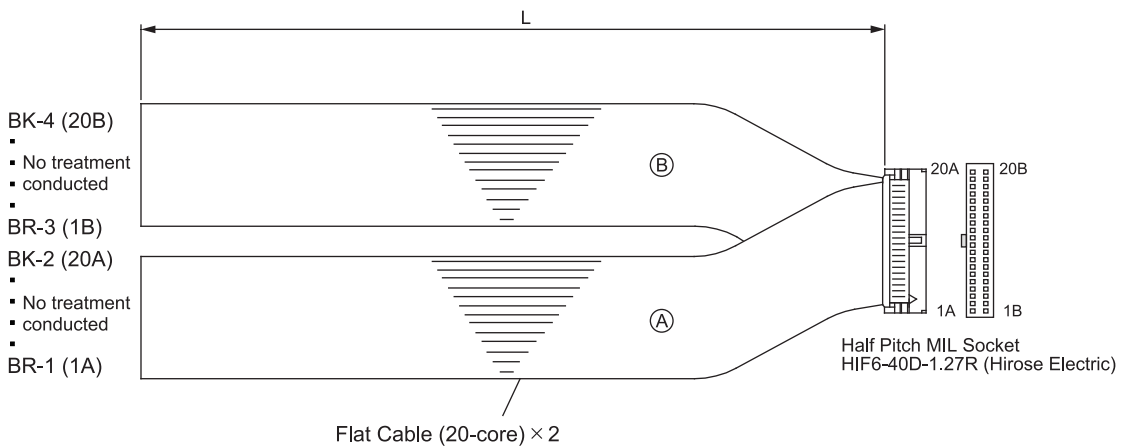

2) PIO Pattern 7..... Pulse Train Control Mode (Absolute Type for Actuator)

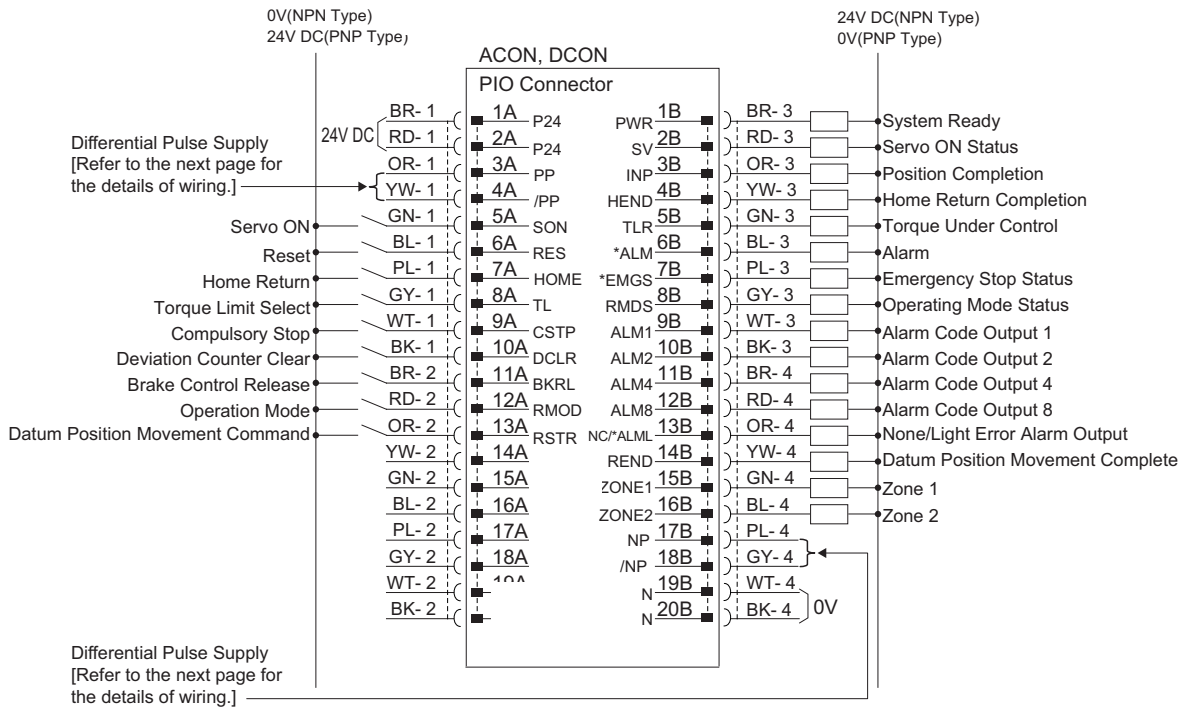

“**” in codes above shows the signal of the active low. Processing occurs when an input signal of the type is turned OFF. An output signal of the type is normally ON in the power-on status and turned OFF at signal output.

- Use the attached cable for the I/O connection.

Model : CB-PAC-PIO□□□□ (□□□□ indicates the cable length L. Example. 020 = 2m)

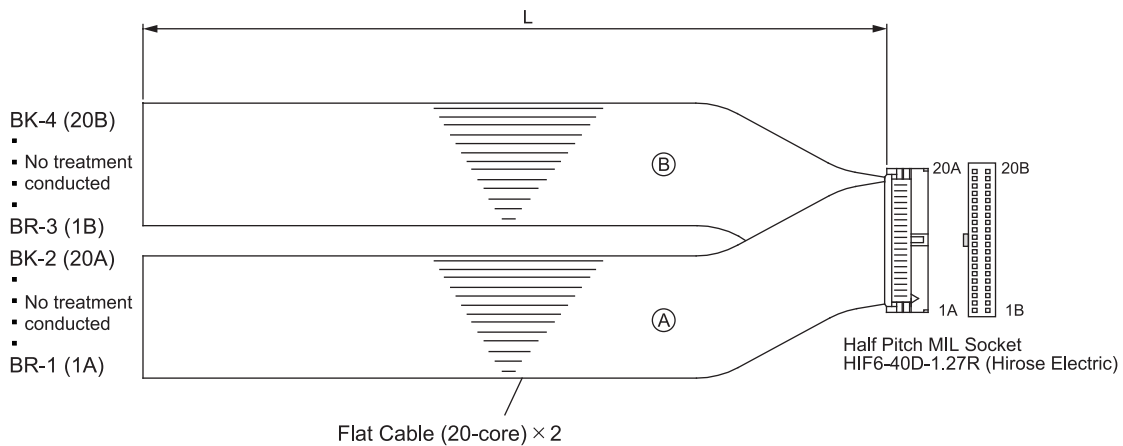

[4] Circuits for Pulse Train Control

● When Host Unit is Differential System

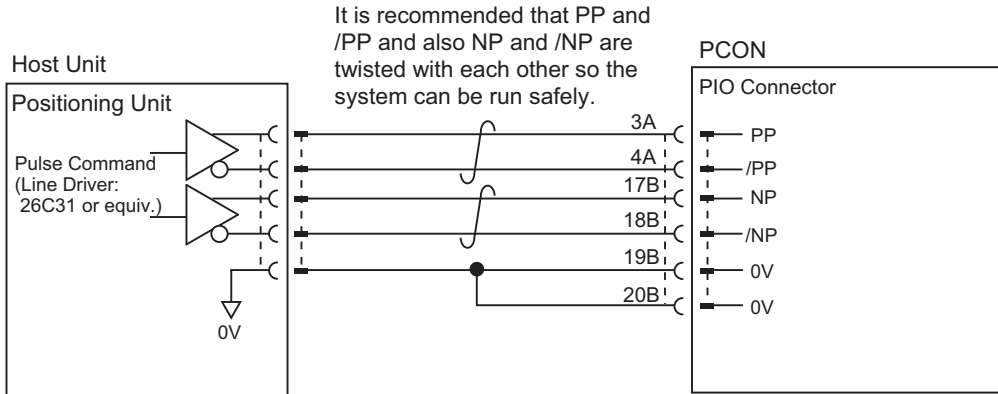

⚠ Caution : Make short-circuit between the host (positioning unit) and the 0V on PIO connector.

● When Host Unit is Open Collector System

AK-04 (to be purchased separately) is required for pulse train input.

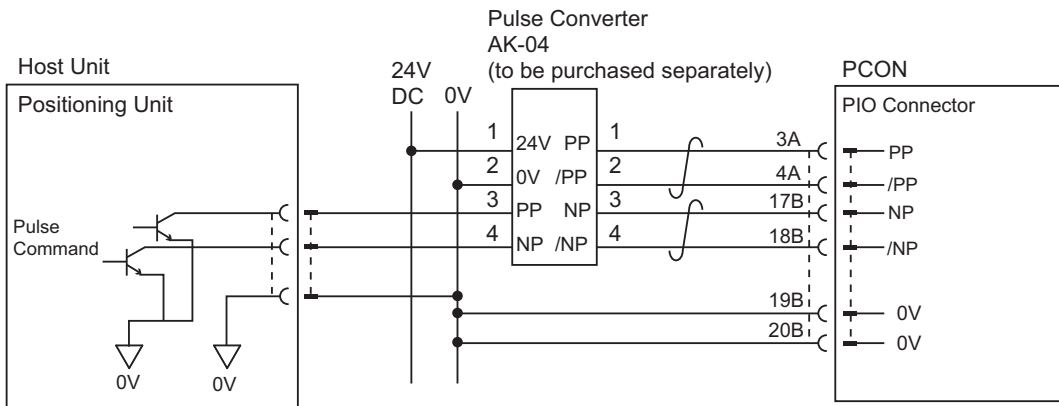

⚠ Caution : 1) Use the same power source for the host open collector input and output, AK-04.
2) Have the cables as short as possible between the host unit and AK-04.

2.3 Wiring Method

2.3.1 Wiring Layout of Power Supply Connector

The wires of the power supply and the emergency stop circuit are to be connected to the controller enclosed connector (plug).

Strip the sheath of the applicable wires for 10mm and insert them to the connector.

- 1) Push a protrusion beside the cable inlet with a small slotted screwdriver to open the inlet.
- 2) After inserting a cable, remove the slotted screwdriver from the protrusion to fix the cable.
- 3) After establishing the wiring layout, plug in the enclosed connector to the power connector on the controller side.

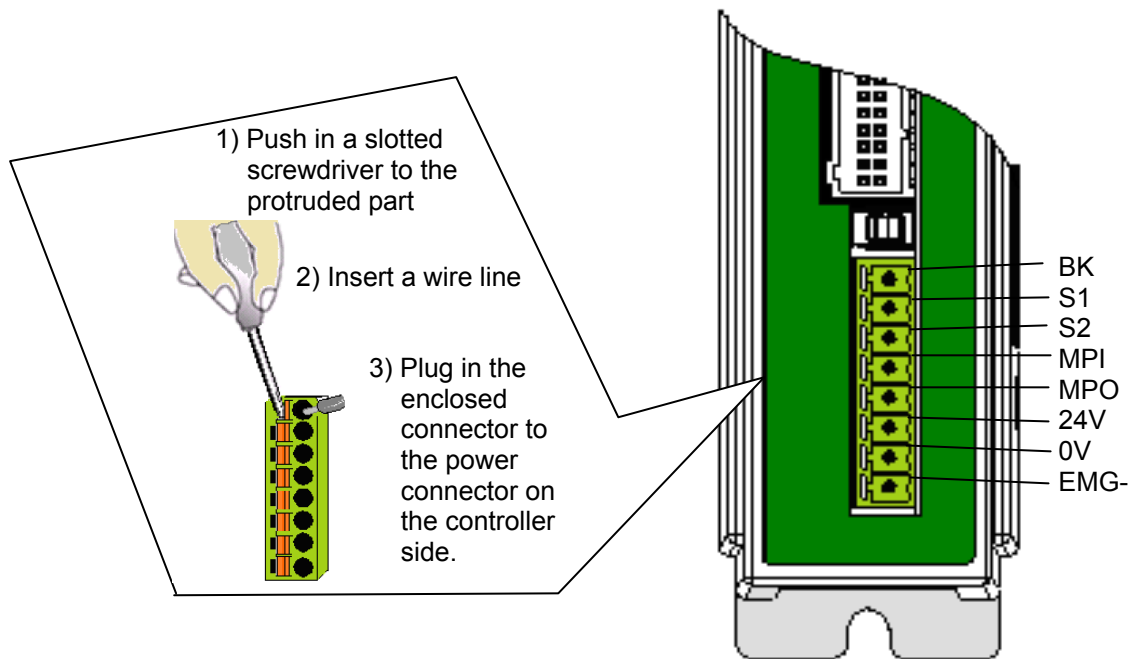

Power Supply Connector	Model	Remarks
Cable Side	FMC1.5/8-ST-3.5	Enclosed in standard package
Controller Side	MC1.5/8-G3.5	

Pin No.	Signal Name	Contents	Applicable cable diameter
1	EMG-	Input of emergency stop status signal	KIV0.5mm ² (AWG20)
2	0V	Power supply input (24V DC ±10%) ^(Note1)	KIV1.25mm ² (AWG16)
3	24V		
4	MPO	Motor drive power line	KIV1.25mm ² (AWG16)
5	MPI		
6	S2	Teaching pendant	KIV0.5mm ² (AWG20)
7	S1	Signal of emergency stop push button	
8	BK	Brake release power supply input ^(Note2) (24V DC ±10% 150mA)	KIV0.5mm ² (AWG20)

(Note1) If supplying power with using a 24V DC, having it turned ON/OFF, keep the 0V connected and have the +24V supplied/cut (cut one side only).

(Note2) The brake is forcibly released when +24V is supplied. Make the 0V in common with the 0V of the power input.

2.3.2 Connection to Actuator

Connect the cables to the motor • encoder connectors.

Motor • Encoder Connector	Model	Remarks
Cable Side	PADP-24V-1-S	
Controller Side	S24B-PADSS-1	

Controller Side Connector

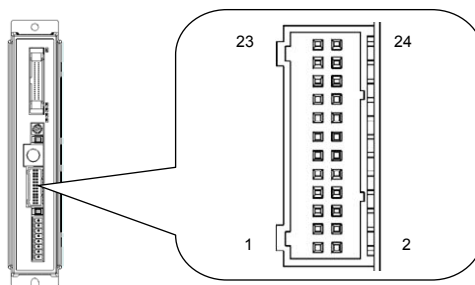

Pin No.	Signal Name	Contents	Applicable cable diameter
1	ϕ A	Motor drive phase A	Cable dedicated for IAI products * Cable for CB and cable for CFB are different.
2	VMM	Motor power supply	
3	ϕ B	Motor drive phase B	
4	VMM	Motor power supply	
5	ϕ /A	Motor drive/Phase A	
6	ϕ /B	Motor drive/Phase B	
7	LS+	Positive side of the limit switch	
8	LS-	Negative side of the limit switch	
9	BK+	Positive side of the brake release	
10	BK-	Negative side of the brake release	
11	NC	Not used	
12	NC	Not used	
13	A+	Encoder A-phase differential + input	
14	A-	Encoder A-phase differential - input	
15	B+	Encoder B-phase differential + input	
16	B-	Encoder B-phase differential - input	
17	CA5V	CA/CB Encoder power	
18	/PS	Encoder line driver enable output	
19	GND	Ground	
20	LSGND	Ground for limit switch	
21	CFB5V	Encoder power output for CFB	
22	NC	Unconnected	
23	NC	Unconnected	
24	FG	Grounding	

2.3.3 Connection of PIO

Conduct the connection of I/O to the controller is to be carried out using the dedicated I/O cable. The cable length is shown in the model code of the controller. Please check the controller model code. There are 2m for standard, 3m and 5m as an option. Up to 10m I/O cables are sold separately. [Refer to 1.1.5 How to read the model]
 Also, the end of the cable harness to be connected to the host controller (PLC, etc.) is just cut and no treatment is conducted so the wiring layout can be performed freely.

Model : CB-PAC-PIO□□□
 (□□□ indicates the cable length L. Example. 020 = 2m)

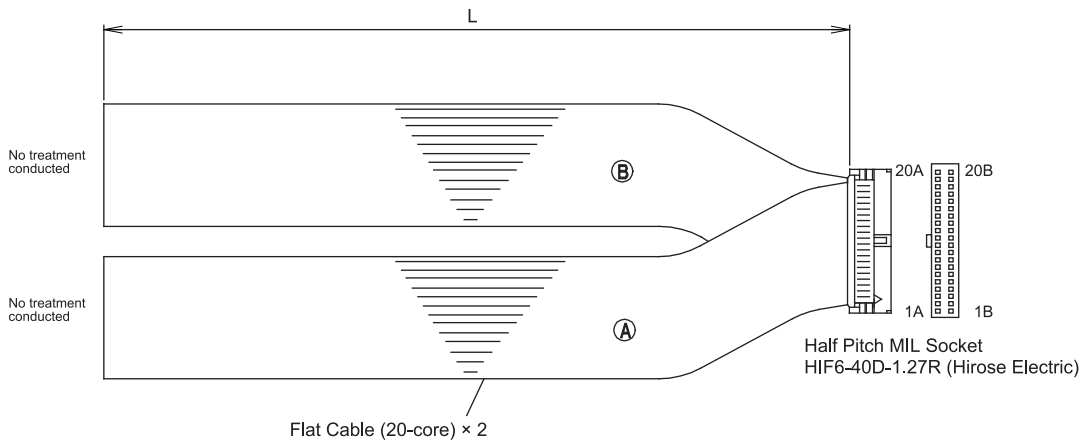

No.	Cable Color	Wiring	No.	Cable Color	Wiring
1A	BR-1	Flat Cable (A) (Press Welding) AWG28	1B	BR-3	Flat Cable (B) (Press Welding) AWG28
2A	RD-1		2B	RD-3	
3A	OR-1		3B	OR-3	
4A	YW-1		4B	YW-3	
5A	GN-1		5B	GN-3	
6A	BL-1		6B	BL-3	
7A	PL-1		7B	PL-3	
8A	GY-1		8B	GY-3	
9A	WT-1		9B	WT-3	
10A	BK-1		10B	BK-3	
11A	BR-2		11B	BR-4	
12A	RD-2		12B	RD-4	
13A	OR-2		13B	OR-4	
14A	YW-2		14B	YW-4	
15A	GN-2		15B	GN-4	
16A	BL-2		16B	BL-4	
17A	PL-2		17B	PL-4	
18A	GY-2		18B	GY-4	
19A	WT-2		19B	WT-4	
20A	BK-2		20B	BK-4	

For the signal assignment of each wire, refer to the following considering the operation mode.
 1) Positioner Mode 2.1.3 [4] PIO Circuit
 2) Pulse Train Control Mode 2.2.3 [3] PIO Circuit

2.3.4 Connection of Pulse Train Signal

Pulse train is input to PIO connector.

Insert the wires to the indicated pin numbers.

[Refer to 2.2.3 [4] Circuits for Pulse Train Control]

If the output pulse of the host controller is open collector type, use the following pulse converter.

- Pulse converter : AK-04 (to be purchased separately)
It converts the command pulse of the open collector type to the differential type.

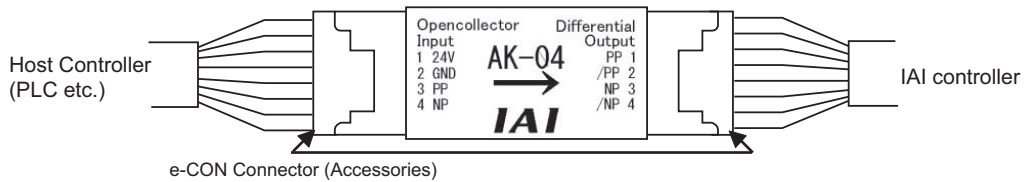

e-CON Connector (Accessories)

Connector Color	Applicable Cable Diameter	Model (manufactured by Sumitomo 3M)
Body Black, Cover Yellow	AWG24 to 26	37104-3122-000FL
Body Gray, Cover Red	AWG26 to 28	37104-4101-G00FL

Caution

- 1) Pay attention not to insert wrongly because it is the same e-CON connector as input and output. Putting the power on with the insertion being wrong will burn AK-04.
- 2) Use the pulse converter in the ambient temperature range between 0°C and 40°C.
- 3) The temperature increase of about 30°C occurs during operation. Accordingly, neither install several pulse converters in close contact nor install them within a duct. Do not install the pulse converter near other heating devices.
- 4) If more than one pulse converters are installed, set a pulse converter apart from another by 10mm or more.
- 5) Make the wiring between the host controller (PLC, etc.) and AK-04 as short as possible. Long wires make it easy to pick up noise. Also make the wiring between AK-04 to this controller as short as possible. Place AK-04 close to the host controller.
- 6) The device is not available for connection to a PNP pulse train type (Model Code: PLP) controller.

A recommended installation sample is shown in the figure below.

- Make the cable length between the host controller and pulse converter as short as possible.
- Keep pulse converters separated for 10mm or more from each other.

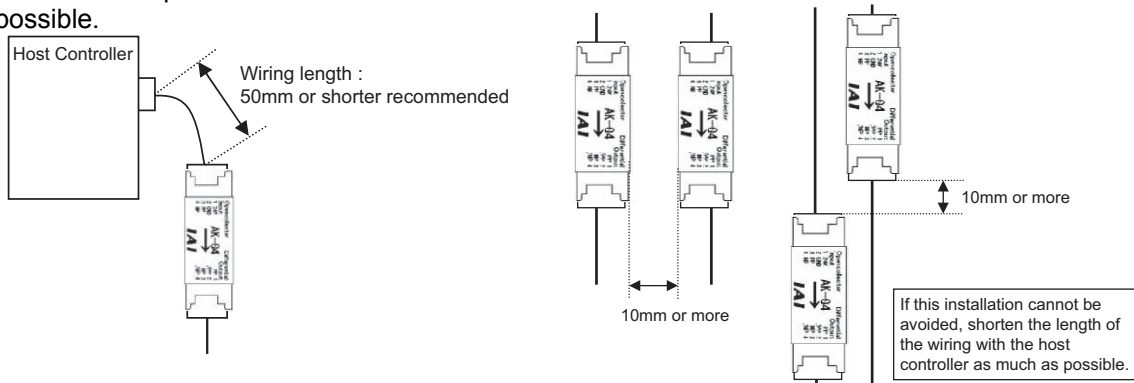

2.3.5 SIO Connector Connection

SIO connectors can be used not only for the connection of teaching tool, but also for the connection of the host controller (PLC, touch panel and PC).

For the operation, refer to the instruction manual of each module.

[Refer to 1.1.3 Instruction manuals related to this product, which are contained in the instruction manual (DVD).]

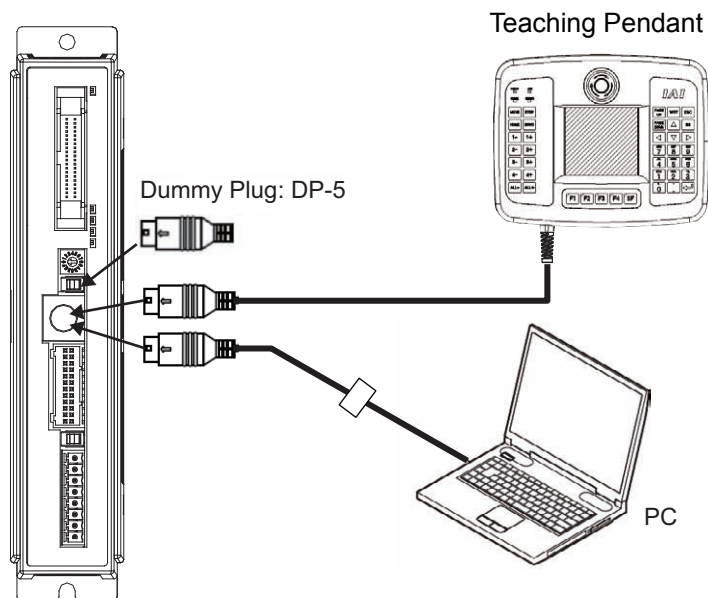

Caution: If the controller is connected with a teaching tool, set the operation mode setting switch to MANU.

If the teaching pendant is removed with the power supply being on, the condition will become the transient emergency stop and the operated actuator will stop.

Do not disconnect the teaching pendant during the operation.

For CGB/CGFB type, in case the teaching pendant is not used, make sure to insert the dummy plug "DP-5" to SIO connectors.

POWER CON **PCON-CB** --- ---

Chapter 3 Operation

3.1 Basic Operation

3.1.1 Basic Operation Methods

There are two types, Positioner Mode and Pulse Train Control Mode, for the operation. Select the suitable one considering the system function.

There are various types of actuators including slider, rod, rotary and gripper types. The same operation control method is applicable unless particular descriptions are contained in this manual.

(1) Positioner Mode

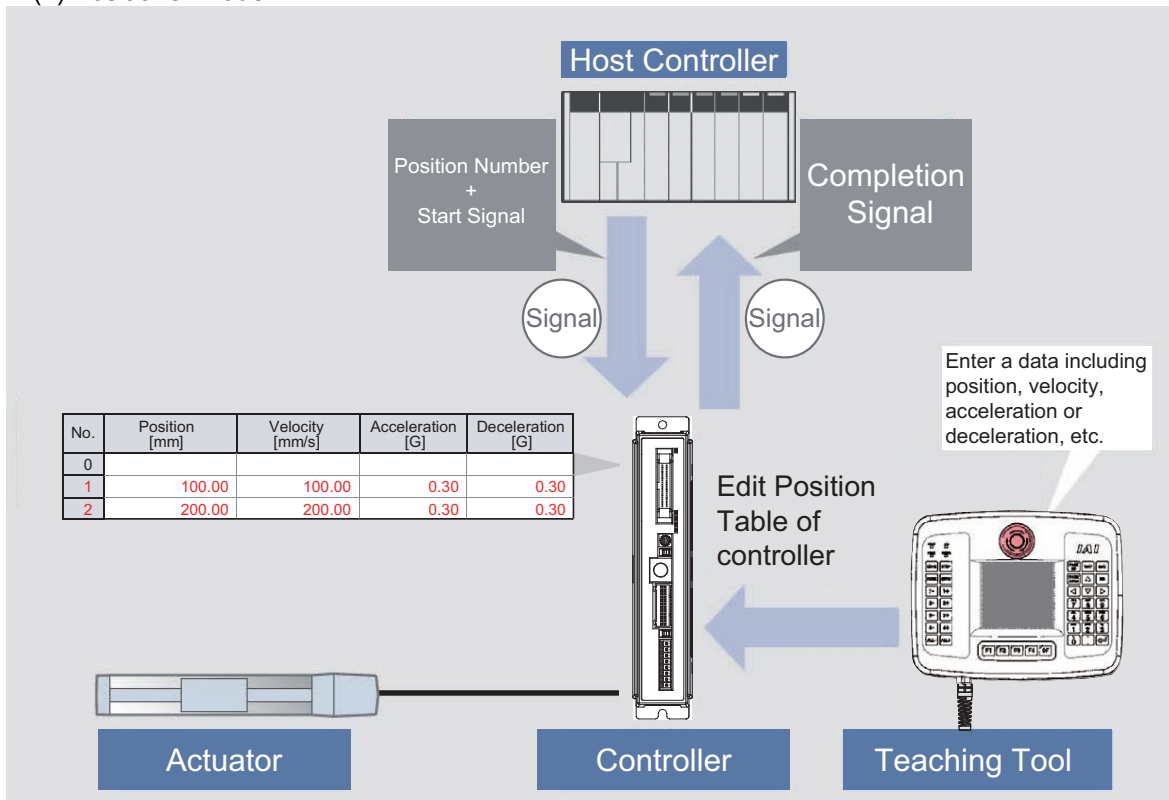

● Operation Ready...Resistration of Position Data (Example of Registration of PC Software)

- Procedure 1 : Turn ON the controller.
- Procedure 2 : Startup a teaching tool such as “PC Software”, and connect to the controller.

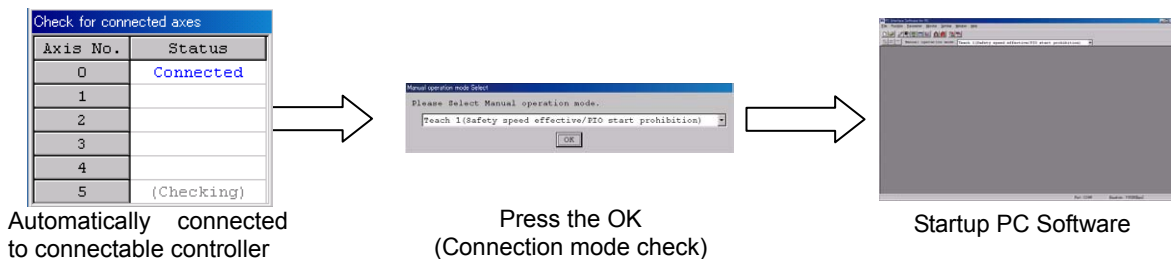

- Procedure 3 : Turn the servo ON, and have a home-return operation.

Select Position -> Edit / Teach in Menu

Open Position Table

- 1) Press the Servo
- 2) Turn on the Servo lamp
- 3) Press the Home
- 4) Turn on the Home lamp (after actuator is stopped)

- Procedure 4 : Define the destination (position) of the slider or rod of the actuator. The destination can be defined by using the following two methods:
 - 1) Read out the coordinate values from such a tool as CAD.
 - 2) Drive the slider or rod with the JOG operation to the destination, and set the position data directly.

- Procedure 5 : Type the destination in the column of Position in Position Table. Once the position is filled, the maximum settable values for Speed and Acceleration/Deceleration are automatically input.

No	Position [mm]	Speed [mm/s]	ACC [G]	DCL [G]
0	10			
1				
2				
3				

No	Position [mm]	Speed [mm/s]	ACC [G]	DCL [G]
0	10.00	150.00	0.20	0.20
1				
2				
3				

☆ Set position directly with JOG operation

- Procedure 6 : Transfer the information such as Position that is written in Position Table to the controller.

Written in red before transferred

Turn to black after transfer complete

Press "Transfer to Controller"

Press the OK

● Operation... Example for Parameters (PIO Patterns 0) at Delivery

- Procedure 1 : Input the position number at which positioning is desired to be performed in the binary data (PC1 to PC32) from a tool such as the host controller, and then turn the start signal (CSTR) ON.
- Procedure 2 : The actuator is placed at the proper coordinate value (destination) according to the positioning information in the specified position number.
- Procedure 3 : If the positioning is completed, the binary data (PM1 to PM32) of the position number is output. The completion signal (PEND) is also output.

The above procedure describes the basic operation method in the positioner mode.

(2) Pulse Train Control Mode

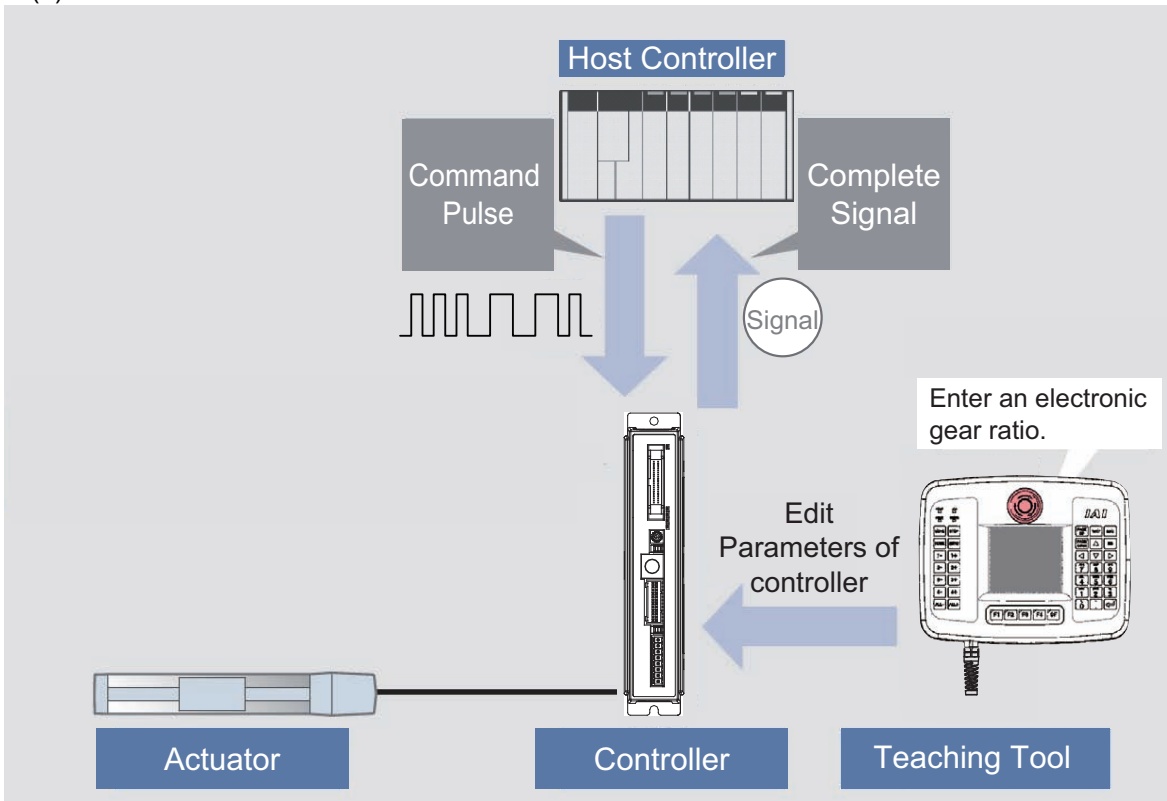

● Operation... Example for When the Parameter Settings at Delivery

- Procedure 1 : Establish the settings for the pulse train form and electronic gear ratio (to determine how many millimeters the actuator moves when 1 pulse is given) to the controller parameters by using a teaching tool such as “PC Software”.

63 Command pulse input mode	1	← Movement direction indication mode by signal
64 Command pulse input mode polarity [0:Plus/1:Minus]	0	
65 Electronic gear numerator	2048	← Positive-Logic Pulse Input
66 Electronic gear denominator	125	

Electronic Gear Ratio = $2048/125 \doteq 16.4$ times
 (Operation made in Unit movement amount per pulse * 16.4)

- Procedure 2 : Send the pulse corresponding to the movement amount of the actuator to the controller from a tool such as the host controller (positioning unit).
- Procedure 3 : The controller calculates the movement amount by multiplying the electronic gear ratio to the number of the pulse input to the controller. Operation made in the movement amount from the current position.
 The speed fluctuates in response to the speed of the pulse (frequency) to be input.
- Procedure 4 : Once the positioning is complete, the completion signal (INP) is output.

The above procedure describes the basic operation method in the “Pulse train control mode”.

3.1.2 Parameter Settings

Parameter data should be set to be suited to the system or application. Parameters are variables to be set to meet the use of the controller in the similar way as settings of the ringtone and silent mode of a cell phone and settings of clocks and calendars.

(Example)

- | | |
|-------------------|---|
| Soft Stroke Limit | : Set a proper operation range for definition of the stroke end, prevention of interferences with peripherals and safety. |
| Zone Output | : Set to require signal outputs in an arbitrary position zone within the operation zone. |

Parameters should be set to meet the use of the controller prior to operation. Once set, they may not set every operation.

Refer to Chapter 7 for the parameter types and the details.

3.2 Operation in Positioner Mode

This controller can switch over the mode between positioner mode and pulse train control mode with the parameters. In the positioner mode, the following 6 types of PIO pattern can be selected with a proper parameter.

This Operational PIO Pattern cannot be switched over after the system is finished to be established or during the actuator operation. Choose the optimum pattern beforehand considering the system operation specifications and prepare the cables and sequence design.

[1] PIO Pattern Selection and Main Functions ○ : Valid function

PIO Pattern (Parameter No.25)		0	1	2	3	4	5	6, 7
Mode		Positioning mode	Teaching mode	256-point mode	512-point mode	Solenoid valve mode 1	Solenoid valve mode 2	Pulse train control mode
Major functions	Number of positioning points	64	64	256	512	7	3	Refer to 3.3
	Operation with the Position No. Input	○	○	○	○	×	×	
	Position No. direct command operation	×	×	×	×	○	○	
	Positioning	○	○	○	○	○	○	
	Velocity change during the movement	○	○	○	○	×	×	
	Pressing (tension)	○	○	○	○	○	×	
	Pitch Feeding (relative moving feed)	○	○	○	○	○	×	
	Home return signal input	○	○	○	○	○	×	
	Pause	○	○	○	○	○	△*1	
	Jog moving signal	×	○	×	×	×	×	
	Teaching signal input (Current Position Writing)	×	○	×	×	×	×	
	Brake release signal input	○	×	○	○	○	○	
	Moving Signal Output	○	○	×	×	×	×	
	Zone signal output	○	×	×	×	○	○	
	Position zone signal output	○	○	○	×	○	○	

*1 The pause signal is not provided. [Refer to 3.2.6 [5].]

(Reference)

Zone signal output signal : The zone range is set to the Parameters No.1 and 2 or No.23 and 24, and becomes always effective after the home return is complete.

Position zone signal : This feature is associated with the specified position number. The zone range is set in the position table. The zone range is enabled only when the position is specified but disabled if another position is specified.

[2] Overview of Major Functions

Major functions	Description
Number of positioning points	Number of positioning points which can be set in the position table.
Operation with the Position No. Input	Normal operation started by turning the start signal ON after position No. is entered with binary data.
Position No. direct command operation	Operation enabled by turning the signal directly corresponding to a position No. ON
Positioning	Positioning enabled at an arbitrary position by the data set in the position table
Velocity change during the movement	Velocity change enabled by activating another position No. during movement
Pressing (tension)	Operation by an arbitrary pressing (tensile) force set in the position table enabled
Pitch Feeding (relative moving feed)	Pitch feed by an arbitrary moving distance set in the position table enabled
Home return signal input	Input signal exclusively used for home return. Set to ON to start home return
Pause	The operation can be interrupted or continued by setting this signal to ON or OFF, respectively.
Jog moving signal	The actuator can only be moved while the input is set to ON.
Teaching signal input (Current Position Writing)	Setting the input signal to ON allows the coordinate value in the stop state to be written to the position table.
Brake release signal input	The brake (option) can only be released while the input is set to ON.
Moving signal output	The output signal is set to ON while the actuator is moved.
Zone signal output	The output signal is set to ON while the actuator is entered within the zone defined by the coordinate values set as parameters.
Position zone signal output	The output signal is set to ON while the actuator is entered within the zone defined by the coordinate values set in the position table.

[3] Operation Modes of Rotary Actuator in Multiple Rotation Mode and Command Limitations

An actuator of multi-rotation specification includes two operation modes, the normal mode enabling only a limited number of rotations and the index mode ^(Note 1) enabling a number of rotations. A specific operation mode can be selected by parameter No.79 "Rotational axis mode selection". Parameter No.80 "Rotational axis shortcut selection" allows the shortcut to be made valid or invalid.

Note 1 There are limitations in operation in Index Mode for Rotary Actuator. [Refer to Precautions in Operation 10]

The table below lists the settings of parameters and the operation specification in each mode.

Rotary axis mode Parameter No.79	Rotational axis shortcut selection Parameter No.80	Current position indication	Absolute position command zone	Relative position command zone	Soft Limit Enabling/ Disabling
0 (Normal Mode)	0 (Disabled)	-9999.99 to 9999.99 (Note 2)	-0.15 to 9999.15 (Note 2)	-9999.30 to 9999.30 (Note 2)	Enabled
1 (Index Mode)	0 (Disabled)	0 to 359.99	0 to 359.99	-360.00 to 360.00	Disabled
	1 (Enabled)				

Note 2 : It is limited within the range of the software limit.

3.2.1 Set of Position Table (This section is not required in selection of pulse train control mode.)

The values in the position table can be set as shown below. For only positioning, only the position data may be written if specifying the speed, acceleration, and deceleration is not required. The speed, acceleration, and deceleration are automatically set to the data defined by the relevant parameters. Therefore, setting the speed, acceleration, and deceleration data often used to the relevant parameters makes input easy.

1)	2)	3)	4)	5)	6)	7)	8)	9)	10)	11)	12)	13)	14)	15)	
No.	Position [mm]	Velocity [mm/s]	Acceleration [G]	Deceleration [G]	Pressing [%]	Threshold [%]	Positioning width [mm]	Zone+ [mm]	Zone- [mm]	Acceleration/Deceleration mode	Incremental	Transported load	Stop mode	Vibration suppress No.	Comment
0	0.00	100.00	0.30	0.30	0.00	0.00	0.10	0.00	0.00	0	0	0	0	0	
1	100.00	100.00	0.30	0.30	0.00	0.00	0.10	0.00	0.00	0	0	0	0	0	
2	150.00	200.00	0.30	0.30	50.00	0.00	30.00	0.00	0.00	0	0	0	0	0	
3	200.00	400.00	1.00	1.00	0.00	0.00	0.10	0.00	0.00	0	0	0	0	0	1
4	200.00	200.00	0.30	0.30	0.00	0.00	0.10	250.00	230.00	0	0	0	0	0	2
5	500.00	50.00	0.10	0.10	0.00	0.00	0.10	0.00	0.00	0	0	0	0	0	
6															
7															

 **Caution:** The input value is treated as the angle for the rotary actuator and lever type gripper. Therefore;
 [mm] → [deg]..... 1.2=1.2deg
 [mm/s] → [deg/s]..... 100=100deg/s
 Note that the notation is [mm] on the screen of the teaching tool such as PC software.

1) Position No. The number is specified by PLC at start.

 **Caution:** Do not use position No.0 if available positions remains enough. At the first servo ON after power ON, the completed position No. output is 0 even if the actuator is not located at position No.0. The actuator enters into the same state as that at positioning to position No.0. The completed position No. output is 0 during movement of the actuator. To use position No.0, get the command history by using the sequence program to check completed position No.0 based on the history.

2) Position [mm] Positioning coordinate value. Enter it as the distance from the home position.
 For pitch feed (relative movement = incremental feed), enter the pitch width.
 A value with – indicates that the actuator moves toward the home position. A value without – indicates that the actuator moves to be away from the home position.

 **Caution:** (1) In the case of a Gripper Type
 Set the coordinate value on the single finger basis. Set the moving distance of a single finger from the home. In the specification, the stroke indicates the total moving distance of both fingers. Thus the actual stroke is a half of the value in the specification.
 (2) In the case of a Rotary Type
 Set the coordinate value by an angle from the home.

- 3) Velocity [mm/s] Set the velocity in the operation.
Do not attempt to input a value more than the maximum velocity [refer to the caution note below] or minimum velocity ^(Note 1).
Note 1 The minimum velocity differs depending on the type of the actuator. Refer to the values stated in the appendix in Chapter 9 or the following for the calculation.
Min. Speed [mm/s] = Lead Length [mm] / No. of Encoder Pluses / 0.001[s]
- 4) Acceleration [G] Set the acceleration at start.
- 5) Deceleration [G] Set the deceleration at stop.

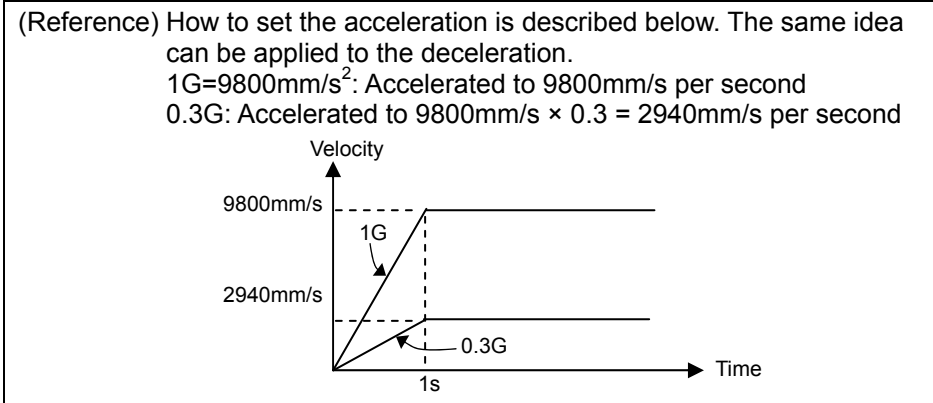

⚠ Caution: (1) Set the velocity, acceleration and deceleration so that they do not exceed the rating values described in the brochure or the instruction manual of the actuator. Failure to follow this may cause the life of the actuator to be shortened extremely.
(2) If shocks and/or vibrations appear on the actuator and/or the work, lower the acceleration and/or the deceleration. In such cases, do not continue the use of the actuator, otherwise the product life may be shortened extremely fast.
(3) If the payload is extremely lighter than the rated payload, increase accel..., acceleration/deceleration to larger than their rated values to shorten the tact time. Please contact IAI for the settings in such situation. Inform us of the weight, shape and mounting method of the work and the installation conditions of the actuator.
(4) For the actuator of gripper type, set the velocity, acceleration and deceleration on the single finger basis. Note that the relative velocity, acceleration and deceleration between both the fingers are as twice as the setting values.

- 6) Pressing [%] Setting proper data here allows pressing to be done. Set a pressing torque (limit current value) in %. If the value is set to 0, the normal positioning operation is performed.
The speed for the pressing operation is set in Parameter No.34.
If the setting of 3) is lower than the pressing velocity, the pressing process will be conducted with the velocity of 3).

⚠ Caution: If the pressing velocity is changed, the pressing force may differ from that specified in 9.6 List of Specifications of Connectable Actuators. When the pressing velocity is changed, make sure to measure the actual pressing force before start using.

- 7) Threshold [%] Set the threshold value of the pressing torque in %.
If the torque (load current) becomes larger than this setting value during pressing, the detection signal is output. This feature is used to monitor the load current and judge whether the operation is good or not in such an operation as press fitting in pressing.

- 8) Positioning width [mm] For positioning in PIO patterns^(Note 1) 0 to 4, the positioning complete signal is output if the remaining moving distance is entered within the zone set here.
 For the pressing operation, the actuator should move in the same velocity and acceleration/deceleration as those set for the normal positioning till it reaches the point set in 2), and then starts pressing drive for the amount of data set in this section.

For PIO pattern 5, this item is not the complete signal output range against positioning command. Just as it does in detection with a sensor, the applicable output signal (LS*) should turn ON once the actuator gets in the range of the setting values regardless of the indicated position number. PIO pattern 5 does not correspond to the pressing operation.

Make sure to set a value of the minimum positioning width or higher for the positioning width.

(For 800 pulse encoder)

$$\text{Min. Positioning Width} = \text{Lead Length} / 800 (\text{Number of Encoder Pulse}) \times 3$$

(For 8192 pulse encoder)

$$\text{Min. Positioning Width} = \text{Lead Length} / 8192 (\text{Number of Encoder Pulse})$$

Note 1 PIO pattern: This is the operation pattern of Positioner mode.
 [Refer to 3.2 Operation in Positioner Mode]

[Output Range of LS Signal (Example of PIO pattern 5)]

The figure below shows the position table and the position at which each of the LS signals is turned ON. If the actuator passes any of the positioning bands in the operation by another position number or manual operation in the servo-off state, the relevant LS signal is always turned ON.

No.	Position [mm]	Velocity [mm/s]	Acceleration [G]	Deceleration [G]	Pressing [%]	Threshold [%]	Positioning width [mm]	Zone+ [mm]	Zone- [mm]	Acceleration/Deceleration mode	Incremental	Transported load	Stop mode
0	0.00	250.00	0.20	0.20	0	0	5.00	0.00	0.00	0	0	0	0
1	70.00	250.00	0.20	0.20	0	0	10.00	0.00	0.00	0	0	0	0
2	150.00	250.00	0.20	0.20	0	0	5.00	0.00	0.00	0	0	0	0

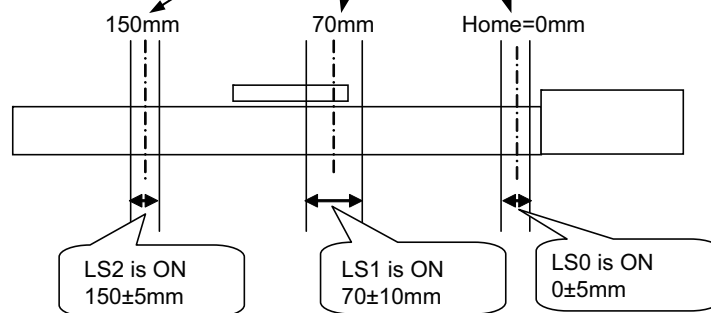

- 9) Zone + [mm] Set the coordinate value on the positive side at which position zone output signal PZONE is turned ON. PZONE is set to ON in the zone between this value and the coordinate value on the negative side set in 10). The feature follows the specified position number. It is valid only when the position is specified but invalid in another position operation.
- 10) Zone - [mm] Set the coordinate value on the negative side at which position zone output signal PZONE is turned ON.

- 11) Acceleration / deceleration modeSelect a proper acceleration/deceleration pattern depending on the load.

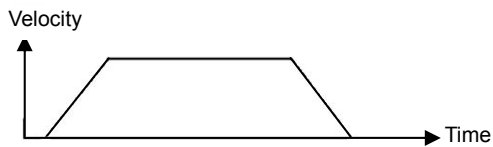
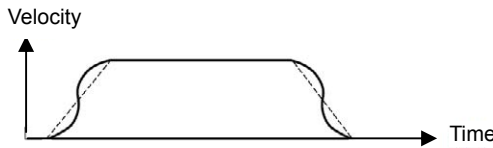
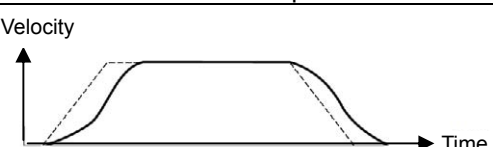
Set Value	Acceleration/ Deceleration Pattern	Operation
0	Trapezoid	
1	S-motion (Refer to Caution at S-shaped Motion)	 <p>Set the S-motion rate with parameter No.56.</p>
2	First-Order Lag Filter	 <p>Set the delay time constant with parameter No.55.</p>

⚠ Caution at S-shaped Motion:

- 1) Since it requires a speed change during the operation, even if having the position command or direct command that S-shaped motion is set while the actuator is moving, S-shaped motion control cannot be performed and will be the trapezoid control. Make sure to make a command while the actuator is stopped.
- 2) S-shaped motion control is invalid in the index mode of the rotary actuator. It will be the trapezoid control even if S-shaped acceleration/deceleration control is indicated.
- 3) Do not use S-shaped acceleration/deceleration control if the setting of the acceleration time or the deceleration time exceeds 2 seconds. It will not provide the right operation.
- 4) Do not pause on the move during acceleration or deceleration. It will change the speed (acceleration) and may cause a danger.

⚠ Caution on First-Order Lag Filter :

Even if the position command or direct value command is conducted with first-order lag filter being set while the actuator is operated in order to have a speed change during an operation, it will not make first-order lag filter control, but will make trapezoid control. Make sure to issue the command while the actuator is stopped.

- 12) Incremental Set to 1 for pitch feed (relative movement = incremental feed).
 The value set for the position in 1) indicates the pitch feed distance.
 With the value set to 0, positioning is defined to the position in 1) based on the absolute coordinate system.

⚠ Caution: In the pitch feed, do not perform a command with a pitch smaller than the minimum encoder resolution (lead/encoder pulse number) or that less than positioning accuracy repeatability.
 There would be no deviation to occur even with the command because it is an operation command to the same position as the positioning complete condition, but the positioning control cannot be performed properly.
 When solenoid valve mode 2 is selected, set this to 0. Setting this to 1 causes the position data error to occur.

- 13) Transported load Register 4 types of load weights with using the teaching tool, and choose the number from the registered numbers (0 to 3) that is to be used.
 From the numbers (load weights) registered in this section, the smart tuning function calculates the optimum speed and acceleration/deceleration.

[Refer to the instruction manual of each teaching tool for how to register the load weights and smart tuning function.]

Setting	Name
0	Transported Load No.0
1	Transported Load No.1
2	Transported Load No.2
3	Transported Load No.3

- 14) Stop mode Automatic servo OFF is enabled after a certain period from the completion of positioning for power saving.
 A proper period can be selected from three parameters.

Setting	Operation after completion of operation	parameter No.
0	Servo ON not changed	—
1	Automatic servo OFF after certain period	36
2	Automatic servo OFF after certain period	37
3	Automatic servo OFF after certain period	38
4	Full servo control	—
5	Full-servo control for a certain time and then automatically turning servo OFF	36
6	Full-servo control for a certain time and then automatically turning servo OFF	37
7	Full-servo control for a certain time and then automatically turning servo OFF	38

 **Caution:**

- No retaining torque is provided in automatic servo OFF. Pay sufficient attention to the setting because the actuator may be moved by external force applied to it.
- Do not use the automatic servo OFF if the next moving command is relative distance specification (pitch feed). Failure to follow it may cause position shift to occur.
- Do not use the automatic servo OFF in pressing. If used, the pressing force is lost.
- Automatic Servo OFF would not function in the operation with teaching mode of PC software.
- The stop mode set in the position table would not be activated if conducting only servo-ON and not conducted positioning even for once to the position. [Refer to the 5.2 Power-Saving Function for the details]
- For the pulse motors other than high-resolution encoder, positioning should complete once the encoder value reaches ± 4 counts of the target position. If higher accuracy is required for positioning, activate the full servo function. [Refer to the 5.2.1 Automatic Servo-off and Full Servo Functions for the details]

- 15) Vibration suppress No. Do not set up.
 When RCP6 is connected, the control becomes the same as the full servo control. Do not select the full servo control.

3.2.2 Control of Input Signal

The input signal of this controller has the input time constant of 6ms considering the prevention of wrong operation by chattering and noise.

Therefore, input each input signal for 6ms or more ^(Note 1) continuously. The signal cannot be identified if it is less than 6ms.

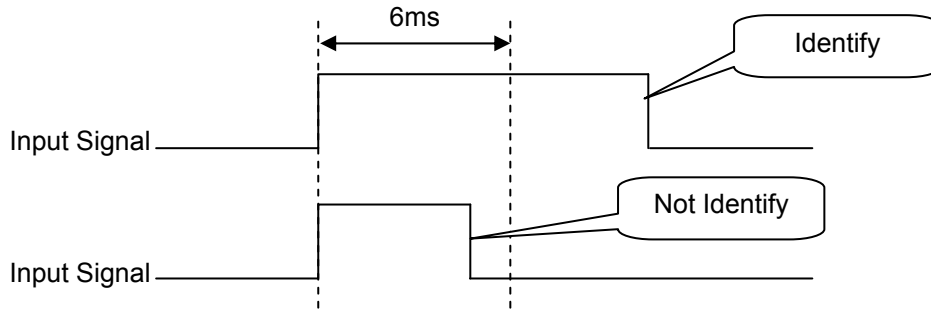

Note 1 It is necessary to input 26ms or more for PWRT Signal of PIO Pattern 1.
 [Refer to 3.2.4 Operation with the Position No. Input = Operations of PIO Patterns 0 to 3]

3.2.3 Operation Ready and Auxiliary Signals = Common to Patterns 0 to 5

[1] Emergency Stop Status (EMGS)

PIO signal	Output
	*EMGS
Common to Patterns 0 to 5	○

○ : Available, ×: Unavailable

- 1) The emergency stop status EMGS is turned ON when in normal condition and turned OFF when EMG terminal on “2.1.3 [1] Power Supply Connector” is 0V (emergency stop condition or disconnected).
- 2) It turns back ON once the emergency stop condition is released and EMG terminal goes up to 24V DC.
 Have an appropriate safety treatment such as interlock with this signal for the host controller (PLC, etc.).

[Caution] EMGS is different from the emergency stop output caused by a controller alarm.

Caution: It is not an emergency stop output due to an alarm generation of the controller.

[2] Operation Mode (RMOD, RMDS)

PIO signal	Input	Output
	RMOD	RMDS
Common to Patterns 0 to 5	○	○

○ : Available, ×: Unavailable

Two operation modes are provided so that the operation by PIO signals does not overlap with the operation by a teaching tool such as PC software through SIO communication. The mode change is normally done by the operation mode setting switch ON the front panel of the controller.

- AUTO Operation by PIO signals is valid.
- MANU Operation through SIO communication is valid.

However, when having the controller in link connection ^(Note 1) and the teaching tool such as PC software being connected using SIO converter, there is a case the controller and the teaching tool are placed far from each other. In such a case, the controller can be entered into the MANU mode by setting PIO signal RMOD to ON. Because the RMDS signal is set to ON with the MANU mode selected by using the signal, make the operation sequence interlocked.

The table below lists the switches ON the front panel, the modes selected by the RMOD signal and the corresponding output states of the RMDS signal.

Note 1 For the details of the link connection, refer to “9.1 Way to Set Multiple Controllers with 1 Teaching Tool”.

○: Selected or set to ON ×: Unselected or set to OFF

Condition		Status							
Teaching tool such as PC software	PIO Operation Invalid ^(Note 2)	○	○	○	○	×	×	×	×
	PIO Operation Allowed ^(Note 2)	×	×	×	×	○	○	○	○
Switches ON front panel	AUTO	○	○	×	×	○	○	×	×
	MANU	×	×	○	○	×	×	○	○
PIO Input	RMOD	×	○	×	○	×	○	×	○
PIO Output	RMDS	×	○	○	○	×	○	○	○
PIO valid: ◎, PIO invalid: ●		◎	●	●	●	◎	◎	◎	◎

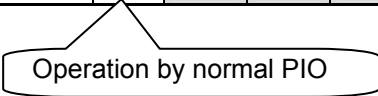

(Note 2) “PIO Operation Allowed” or “PIO Operation Invalid” is the function to select a restriction while the teaching tool such as PC software is connected.

⚠ Caution: (1) Note that selecting “PIO Operation Allowed” by using the teaching tool such as PC software makes all PIO signals valid to enable operation however the states of the switches and RMOD signal input may be. In this status, the actuator may be started depending on the signals from PLC.

(2) If the teaching tool such as PC software is disconnected from the controller, “PIO Operation Allowed” or “PIO Operation Invalid” holds the state selected before. After teaching operation or debugging is terminated, select “PIO Operation Allowed” and disconnect the teaching tool such as PC software from the controller.

[3] Servo ON (SON, SV, PEND)

PIO signal	Input	Output	
	SON	SV	SON
Other than pattern 5	○	○	○
Pattern 5	○	○	×

○ : Available, ×: Unavailable

- 1) Servo ON signal SON is the input signal making the servo motor of the actuator operable.
- 2) If the servo-on is performed to enable operation, the SV output signal is turned ON. Concurrently positioning completion signal PEND is turned ON.
- 3) With the power being supplied, then controller cannot be operated while the SV signal remains OFF. If the SON signal is turned OFF under operation of the actuator, the actuator is decelerated and stopped with the maximum torque. After the stop, the servo OFF occurs to enter the motor into the free running state. The brake (option) is of release-in-excitation type. Therefore, making the excitation on will release the brake while making it off will lock the brake.

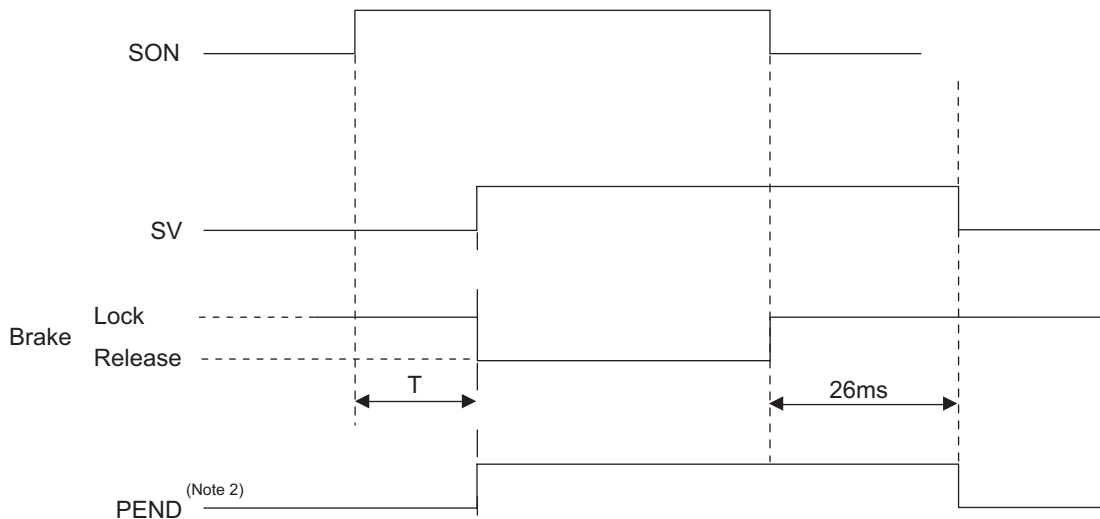

$$T \text{ (before detecting excitation)}^{(Note1)} = \text{SON signal identification (6ms)} + \text{Excitation detection time (T1 + T2)} \times \text{Number of retry (10 times Max.)} + \text{Servo ON delay time (T3)}$$

$$T \text{ (after detecting excitation)}^{(Note1)} = \text{SON signal identification (6ms)} + \text{Servo ON delay time (T3)}$$

- T1 : Parameter No.30 It differs depending on the setting of excitation detection type.
Set Value = 0 → 160ms
Set Value = 1, 2 → 220ms
- T2 : Parameter No.29 Setting of excitation phase signal detection time
It is set to 10ms in the initial setting.
- T3 : Fixed to 20ms

Note 1 Excitation check operation is performed at the first servo-on process after the power is turned on for the incremental type and absolute battery type, and when the home return is completed for the simple absolute type to identify the magnetic poles of the motor.

Note 2 PEND would not turn ON in the pause condition.

[4] Home Return (HOME, HEND, PEND, MOVE)

PIO signal	Input	Output		
	HOME	HEND	PEND	MOVE
Patterns 0 and 1	○	○	○	○
Patterns 2 to 4	○	○	○	×
Pattern 5	×	○	×	×

○ : Available, ×: Unavailable

Note 1: For pattern 5, the home return by the HOME signal is not allowed. Refer to 3.2.6 [1] Home return (ST0, HEND) for how to perform a home-return operation.

The HOME signal is intended for home return. The HOME signal is caught at the rising edge (ON edge) to start the home return. At completion of the home return, home return completion signal HEND is turned ON. Turn OFF HOME Signal after HEND turns ON. Once the home return completion signal HEND turns ON, it keeps ON even the actuator gets off the home position. (HEND turns OFF when the home position gets lost and uncertain.) Even HEND is ON, home-return operation should be performed again by turning HOME Signal ON. HEND turns OFF while the home-return operation is performed, and turns back ON when the home-return operation is completed.

Also, during the home-return operation, positioning completion signal PEND and moving signal MOVE are set to OFF and ON, respectively.

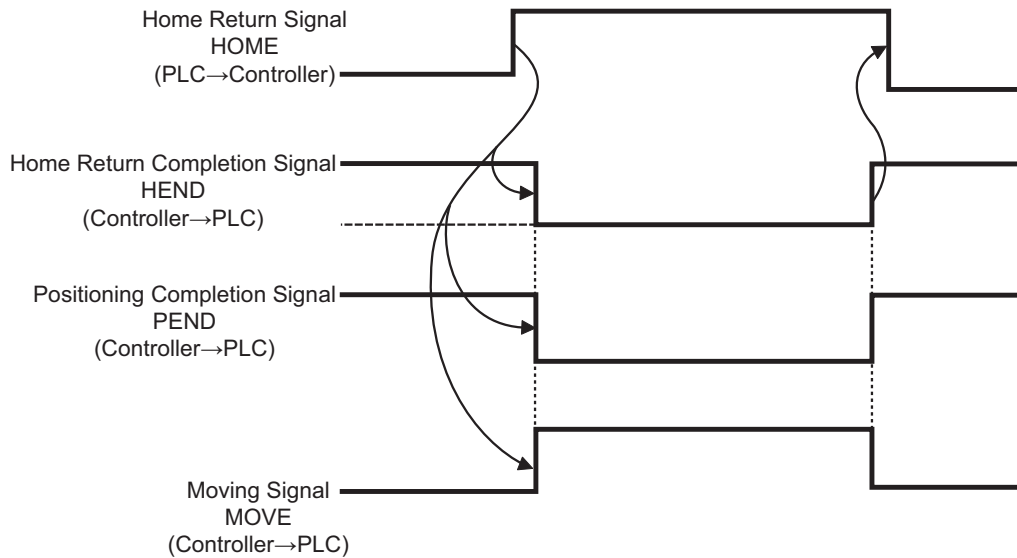

[Home Return Operation of Slider Type/Rod Type Actuator]

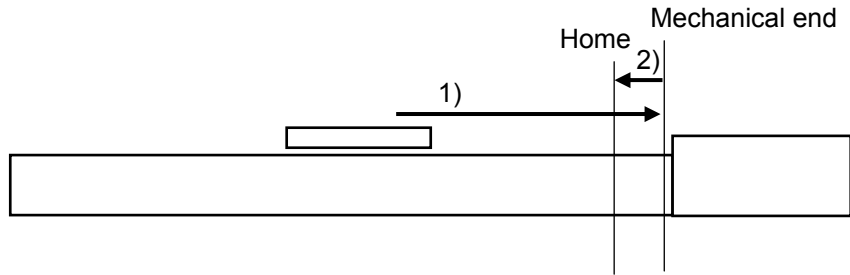

- 1) With the HOME signal being ON, the actuator moves toward the mechanical end at the home return speed.
The moving speed is 20mm/s for most actuators but less than 20mm/s for some actuators.
- 2) The actuator is turned at the mechanical end and stopped at the home position. The moving distance is the value set by Parameter No.22 "Home return offset level".

⚠ Caution: In the home reverse specification, the actuator moves in the reverse direction. Make sure to refer to Section 7.2 [16] when a change to Parameter No.22 "Home return offset level" is required.

[Home Return Operation of Rotary Actuator]

(1) 330° Rotation Specification

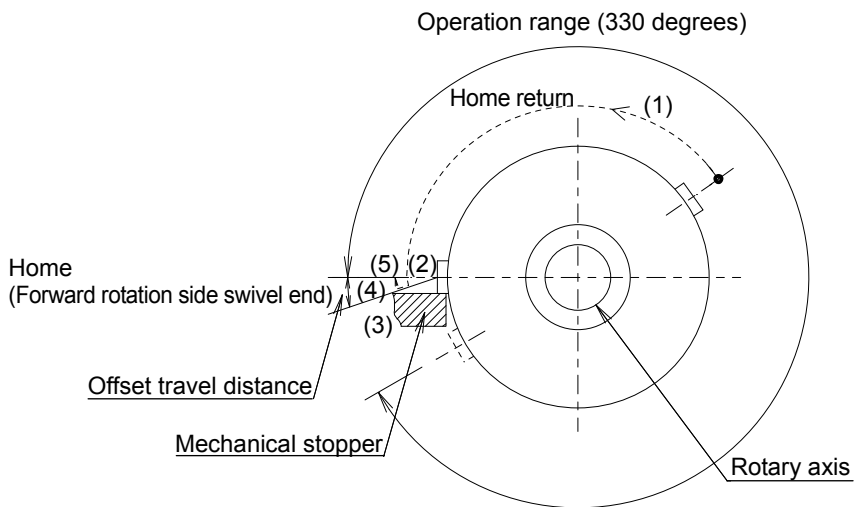

- 1) When home return is commanded, the rotary part rotates in the CCW (counterclockwise) direction as seen from the load side.
The speed is 20 deg/s.
- 2) Detects mechanical stopper.
- 3) It travels in reverse.
- 4) Moves from the position of (3) for the amount set in Parameter No. 22 "Homing Offset" and stops.
- 5) The position stopped in (4) should be the home position.

⚠ Caution: Make sure to refer to Section 7.2 [16] when a change to Parameter No.22 "Home return offset level" is required.

(2) Multi-Rotation Specification

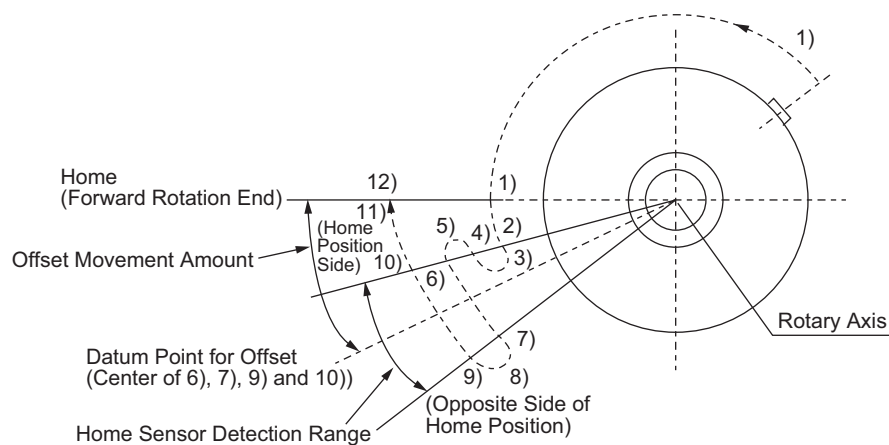

- 1) Once the home-return command is issued, the actuator rotates in CCW (counterclockwise) direction from the view point of the load side. The velocity is 20deg/s.
- 2) Home sensor turns ON.
- 3) Starts reversed rotation.
- 4) Goes back to a point exceeded the home sensor detection range, and confirms the home sensor is turned OFF.
- 5) Starts reversed rotation.
- 6) Confirms the home sensor gets turned ON again.
- 7) Goes to a point exceeded the home sensor detection range on the opposite side of the home position, and confirms the home sensor is turned OFF.
- 8) Starts reversed rotation.
- 9) Confirms the home sensor turns ON.
- 10) Goes to a point exceeded the home sensor detection range on the home position side, and confirms the home sensor is turned OFF.
- 11) Based on the result gained from 6), 7), 9) and 10), the center of the home sensor detection range is calculated.
- 12) Moves for the amount set in Parameter No.22 "Home return offset level" from the position of 11), and stops at the home position.

⚠ Caution: The operation of the reversed rotation type should be in the reversed way. Make sure to refer to Section 7.2 [16] when a change to Parameter No.22 "Home return offset level" is required.

[Home Return Operation of Actuator of Gripper Type]

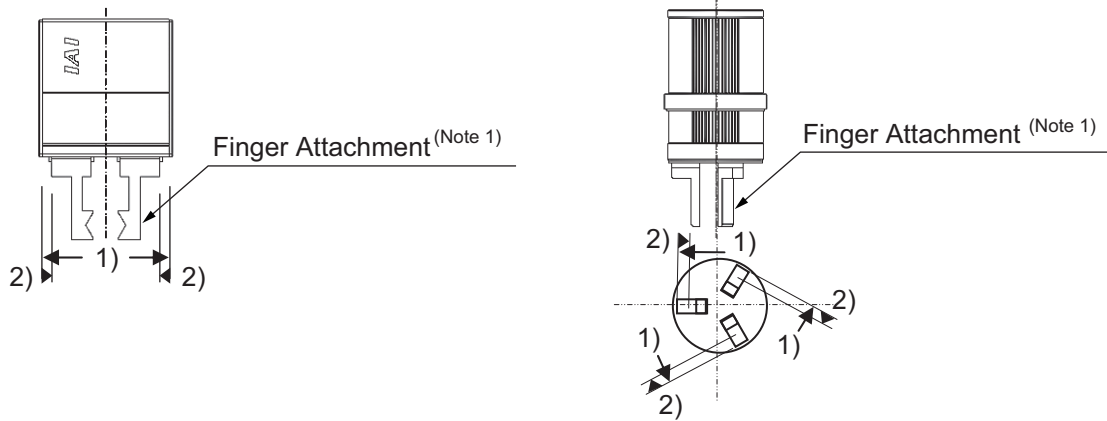

- 1) If the HOME signal is turned ON, the actuator moves toward the mechanical end (to end side) at the home return speed (20mm/s).
- 2) The actuator is turned at the mechanical end and stopped at the home position. The moving distance is the value set by Parameter No.22 "Home return offset level".

 Caution: Make sure to refer to Section 7.2 [16] when a change to Parameter No.22 "Home return offset level" is required.

Note 1 Finger attachment is not included in the actuator package. Please prepare separately.

[5] Zone Signal and Position Zone Signal (ZONE1, ZONE2, PZONE)

PIO signal	Output		
	ZONE1	ZONE2 ^(Note 2)	PZONE ^(Note 2)
Pattern 0	○	○	○
Pattern 1	○ ^(Note 2)	×	○
Pattern 2	○ ^(Note 2)	×	○
Pattern 3 ^(Note 1)	×	×	×
Pattern 4	○	○	○
Pattern 5	○	○	○

○ : Available, ×: Unavailable

Note 1 Pattern 3 does not have the zone signal output feature.

Note 2 In Parameter No.149 Zone Output Switchover, ZONE can be selected instead of PZONE.

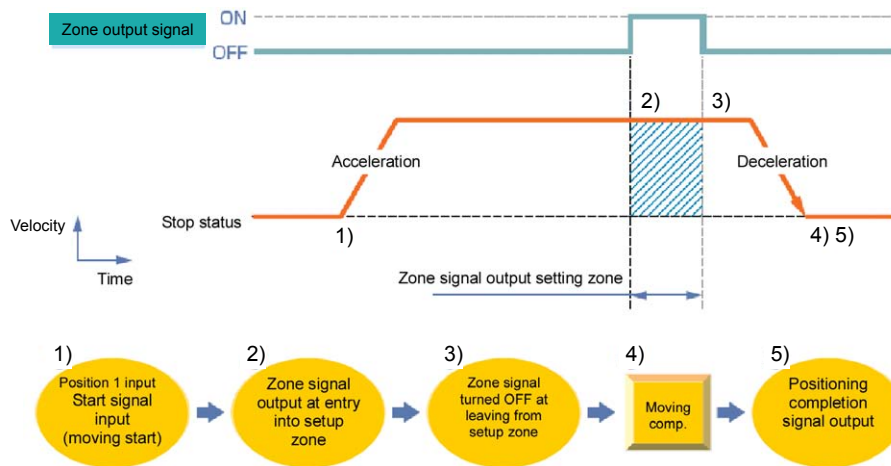

The relevant signal can be turned ON while the actuator passes or stops in the zone range in either of the following 2 types:

- 1) Zone signal (ZONE1, ZONE2) ... The output signal is turned ON at the position set by the proper parameter.
- 2) Position zone signal (PZONE) ... The output signal is turned ON at the position set in the position table.

The feature can play a role as the sensor for judging whether the completion position is good or not in pressing operation, setting the continuous operation zone in pitch feed or interlocking operations of other units in the setting zone.

(1) Zone signal (ZONE1, ZONE2)

Set the zone range to the relevant parameter.

- 1) Parameter No.1 : Zone boundary 1+
- 2) Parameter No.2 : Zone boundary 1-
- 3) Parameter No.23: Zone boundary 2+
- 4) Parameter No.24: Zone boundary 2-

The zone signal ZONE is kept effective also during the emergency stop unless the memory of the origin is lost due to alarm.

(2) Position zone signal (PZONE)

No.	Position [mm]	Velocity [mm/s]	Acceleration [G]	Deceleration [G]	Pressing [%]	Threshold [%]	Positioning width [mm]	Zone+ [mm]	Zone- [mm]	Acceleration/Deceleration mode	Incremental	Transported load	Stop mode
0													
1	0.00	250.00	0.20	0.20	0	0	0.10	50.00	30.00	0	0	0	0
2	100.00	250.00	0.20	0.20	0	0	0.10	70.00	60.00	0	0	0	0
3	50.00	250.00	0.20	0.20	50	0	20.00	60.00	65.00	0	0	0	0

Setting of zone range

Zone ranges should be set in the position table.

While the operation corresponding to a position number is executed, the zone range set for the position number is valid. It is kept effective also during the emergency stop unless the actuator is operated or the memory of the origin is lost due to alarm.

(3) Setting values and signal output range

The zone output range varies depending on the difference between the value set for the positive side of the zone and that for the negative side.

- 1) Value set for positive side > value set for negative side: The output signal is set to ON in the range and OFF out of the range.
- 2) Value set for positive side < value set for negative side: The output signal is set to OFF in the range and ON out of the range.

[Example of Line Axis]

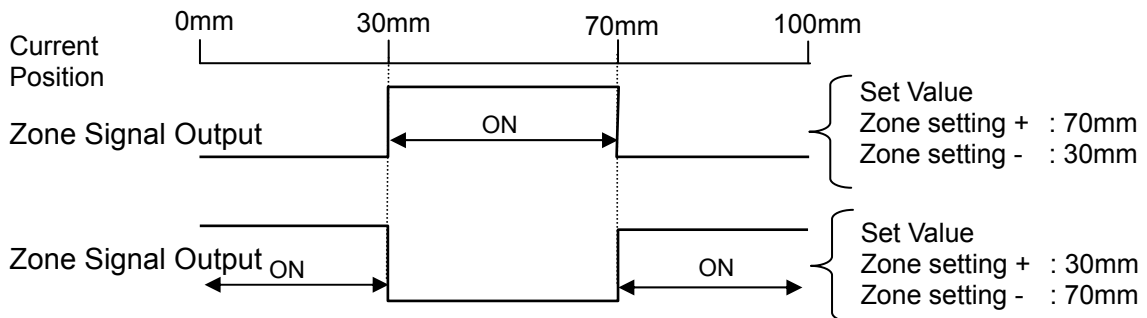

[Example of rotary actuator of multi-rotation specification in index mode]

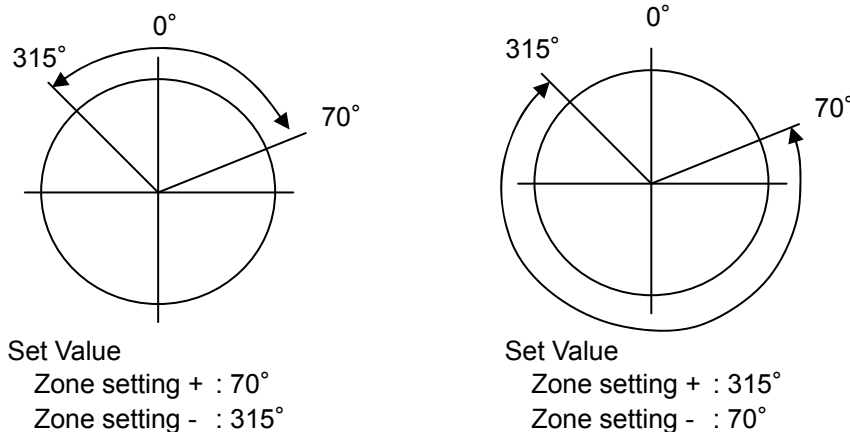

⚠ Caution:

- (1) Since this signal becomes effective after the coordinate system is established after the home return is completed, it would not be output just with the power turned ON.
- (2) The zone detection range would not turn ON unless the value exceeds that of the minimum resolution (actuator lead length/number of encoder pulse).
- (3) The number of encoder pulse differs for each actuator series.
 RCP2, RCP3, RCP4, RCP5 : 800 pulses
 RCP6 : 8192 pulses

[6] Alarm, Alarm Reset (*ALM, RES)

PIO signal	Input	Output
	RES	*ALM
Common to Patterns 0 to 5	○	○

○ : Available, ×: Unavailable

- 1) Alarm signal *ALM is set to ON in the normal status but turned OFF at the occurrence of an alarm at a level equal to or higher than the operation release level.
- 2) Turning reset signal RES ON under occurrence of an alarm at the operation release level allows the alarm^(Note 1) to be released. The action is taken at the rising edge (ON edge).
- 3) The alarm reset should be done after the cause of the alarm is confirmed and removed. If alarm reset and restart are repeated many times without removal of the cause, a severe failure such as motor burnout may occur.

Note 1 Check the 8.4 Alarm List for details of alarms.

 **Caution:** Reset signal RES has two features, or alarm reset under occurrence of an alarm and operation interruption (cancellation of remaining moving distance) under temporary stop. For the operation interruption under temporary stop, refer to the description of the operation in each pattern.

[7] Binary Output of Alarm Data Output (*ALM, PM1 to 8)

PIO signal	Output	
	*ALM	PM1 to 8
Common to Patterns 0 to 3	○	○
Pattern 4 ^(Note 1)	○	×
Pattern 5 ^(Note 1)	○	×

○ : Available, ×: Unavailable

Note 1 Patterns 4 and 5 do not have this function.

- 1) If an alarm at a level equal to or higher than the operation release level occurs, completed position number output signals PM1 to PM8 output the alarm information in the binary code format.
- 2) The PLC can read the binary code of alarm signal *ALM as the strobe signal to refer to alarm information.

○: ON ●: OFF

*ALM	ALM8 (PM8)	ALM4 (PM4)	ALM2 (PM2)	ALM1 (PM1)	Binary Code	Description: Alarm code is shown in ().
○	●	●	●	●	–	Normal
●	●	●	○	●	2	Software reset during servo ON (090) Position number error during teaching (091) PWRT signal detected during movement (092) PWRT signal detected before completion of home return (093) Servo ON command after encoder FRAM read/write (09C)
●	●	●	○	○	3	Move command during servo OFF (080) Position Command in Incomplete Home Return (082) Absolute position move command when home return is not yet completed (083) Movement Command during Home Return Operation (084) Position No. error during movement (085) Move command while pulse train input is effective (086) Command deceleration error (0A7)
●	●	○	●	●	4	FAN error detection (0D6) Field bus module not detected (0F3) Mismatched PCB (0F4)
●	●	○	●	○	5	Field bus link error (0F1) Field bus module error (0F2)
●	●	○	○	●	6	Parameter data error (0A1) Position data error (0A2) Position command data error (0A3) Unsupported motor/encoder type (0A8)
●	●	○	○	○	7	Excitement detection error (0B8) Home sensor non-detection (0BA) Home return timeout (0BE)

(Note) *ALM Signal is an active low signal. It is ON when the power is applied to the controller, and turns OFF when the signal is output.

○: ON ●: OFF

*ALM	ALM8 (PM8)	ALM4 (PM4)	ALM2 (PM2)	ALM1 (PM1)	Binary Code	Description: Alarm code is shown in ().
●	○	●	●	●	8	Actual speed excessive (0C0)
●	○	●	●	○	9	Regenerative electric discharge circuit error (0C7) Overcurrent (0C8) Overvoltage (0C9) Overheat (0CA) Control power source voltage error (0CC) Drop in control supply voltage (0CE) Drive source error (0D4) External output power error (0DE)
●	○	●	○	○	11	Command counter overflow (0A4) Command counter overflow in Incomplete home return (0D5) Deviation Overflow (0D8) Software stroke limit exceeded (0D9) Pressing motion range over error (0DC)
●	○	○	●	●	12	Servo error (0C1) Motor power source voltage excessive (0D2)
●	○	○	●	○	13	Encoder receipt error (0E5) Encoder count error (0E6) A- and B-phase Wire Breaking (0E8) External output power error (0DE) Absolute encoder error detection 1 (0ED) Absolute encoder error detection 2 (0EE) Absolute encoder error detection 3 (0EF)
●	○	○	○	●	14	CPU error (0FA) Logic error (0FC)
●	○	○	○	○	15	Nonvolatile memory write verify error (0F5) Nonvolatile memory write timeout (0F6) Nonvolatile memory data destroyed (0F8)

(Note) *ALM Signal is an active low signal. It is ON when the power is applied to the controller, and turns OFF when the signal is output.

[8] Brake Release (BKRL)

PIO signal	Input
	BKRL
Pattern 0	○
Pattern 1 ^(Note 1)	×
Pattern 2 to 5	○

○ : Available, ×: Unavailable

Note 1 Pattern 1 does not have this feature

The brake can be released while BKRL signal is set to ON. If a brake is installed in the actuator, the brake is automatically controlled by servo ON/OFF. Releasing the brake may be required to move the slider and/or the rod by hand in case of installation of the actuator in the machine or direct teach^{*1}.

This operation can be done by break release signal BKRL as well as the brake release switch ON the front panel of the controller.

*1 Direct teaching : This operation is intended to get coordinate values to the position by moving the slider and/or the rod by hand.

 **Warning:** (1) Take sufficient care to release the brake. Inappropriate brake release may cause people to be injured and/or the actuator, the work and/or the machine to be damaged.

(2) After the brake is released, always make the brake applied again. Any operation with the brake remaining released is extremely dangerous. The slider or rod may drop to cause people to be injured and/or the actuator, the work and/or the machine to be damaged.

(3) Make certain that this signal is turned OFF (brake is activated) when the power is supplied to the controller.

(4) It is prohibited to switch over between AUTO and MANU while this signal is ON (brake is released).

3.2.4 Operation with the Position No. Input = Operations of PIO Patterns 0 to 3

This section describes the methods of operations of PIO patterns 0 to 3. These patterns provide normal controller operation methods in which the controller is operated by turning the start signal ON after a position No. is entered.

The control methods of positioning, pitch feed, and pressing are the same as those described before.

[1] Positioning [Basic] (PC1 to PC**, CSTR, PM1 to PM**, PEND, MOVE, LOAD, TRQS)

PIO signal	Input		Output				
	PC1 to PC**	CSTR	PM1 to PM**	PEND	MOVE	LOAD	TRQS
PIO pattern 0	PC1 to 32	○	PM1 to 32	○	○	×	×
PIO pattern 1	PC1 to 32	○	PM1 to 32	○	○	×	×
PIO pattern 2	PC1 to 128	○	PM1 to 128	○	×	×	×
PIO pattern 3	PC1 to 256	○	PM1 to 256	○	×	×	×

○ : Available, ×: Unavailable

(Note) For incremental type, operation without home return leads the operation based on the data of the specified position No. after automatic home return. If one or more problems are found, interlock by home return complete signal HEND is required.

In the battery-less absolute or simple absolute type, if it gets into a condition that the home-return operation is incomplete due to such a reason as a parameter change, operation to the indicated position number would not be performed, but only the home-return operation should be performed.

■ Sample use

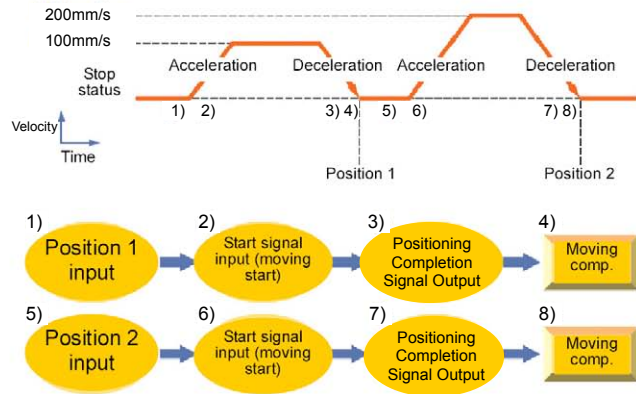
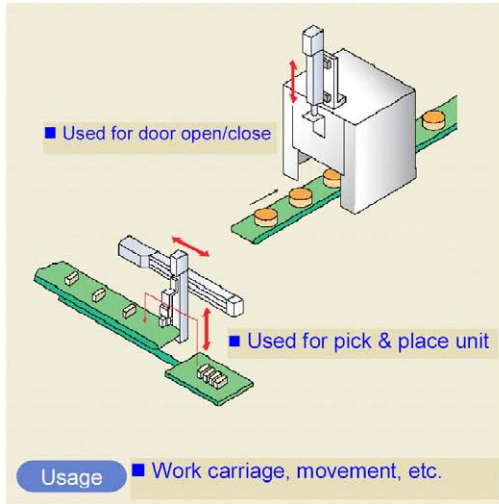

No.	Position [mm]	Velocity [mm/s]	Acceleration [G]	Deceleration [G]	Pressing [%]	Threshold [%]	Positioning width [mm]	Zone+ [mm]	Zone- [mm]	Acceleration/Deceleration mode	Incremental	Transported load	Stop mode
0													
1	70.00	100.00	0.20	0.20	0	0	0.10	0.00	0.00	0	0	0	0
2	150.00	200.00	0.20	0.20	0	0	0.10	0.00	0.00	0	0	0	0

■ Control method

- 1) First enter command position No. PC1 to PC** with binary data. Next turn start signal CSTR ON. Then the actuator starts acceleration depending on the data in the specified position table for positioning to the target position.
- 2) At operation start, positioning complete signal PEND is turned OFF. Always turn the CSTR signal OFF. Without it, the completed position number is not output and the positioning complete signal is not turned ON at the completion of positioning.
- 3) When the positioning is completed, the positioning complete position numbers are output from complete position No.PM1 to PM** with binary data and also positioning complete signal PEND is turned ON.
- 4) Moving signal MOVE is turned ON as soon as the operation is started and turned OFF at the completion of positioning.
- 5) Positioning complete signal PEND is turned ON if the remaining moving distance enters into the positioning width. PEND Signal will be kept ON once it is turned ON unless the start signal CSTR is turned back ON, servo is turned OFF ^(Note 1) or the actuator is out of the positioning band width range ^(Note 1).

Note 1 It can be switched over with Parameter No.39.

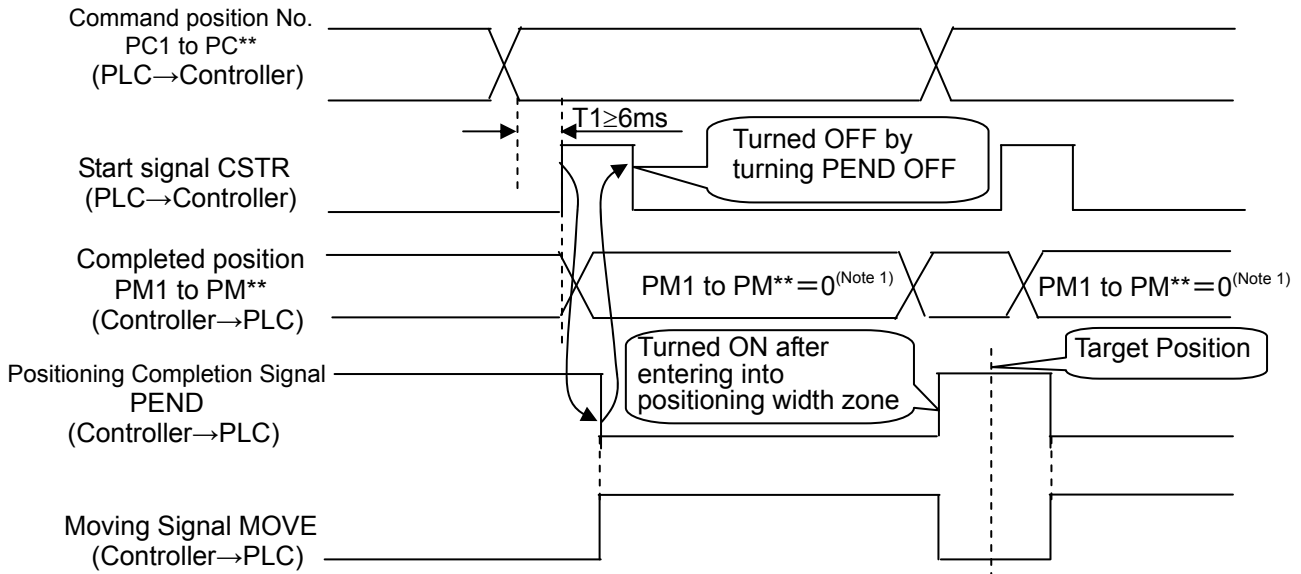

(Note 1) The completion position No. output is set to 0 during movement of the actuator.

⚠ Caution:

- (1) Set the period taken from entering position No. to turning CSTR ON to 6ms or larger. In spite of 6ms timer process in the PLC, commands may be input to the controller concurrently to cause positioning to another position. Take the scanning time in the PLC into account to set a period as 2 to 4 times as the scanning time. Set the value similarly if the PLC reads the complete position.
- (2) At the completion of positioning, positioning complete signal PENDING is not turned ON if start signal SCTR remains ON. If this occurs, turn CSTR OFF then PENDING is turned ON immediately. Therefore, create the sequence program so that turning PENDING ON makes CSTR turned OFF and the PLC waits for the state in which PENDING is turned ON.
- (3) At the positioning to the position same as that specified in the stop (complete) position number, PENDING is turned OFF once but moving signal MOVE is not turned ON. Therefore, use PENDING to turn CSTR OFF.
- (4) MOVE turns on at the same time as PENDING turns OFF, and turns OFF when a movement command is finished or PENDING is turned ON. Therefore, when the positioning band setting is wide, the signal may turn OFF even in the actuator operation, and may turn off prior to PENDING if the positioning band setting is narrow.

■ Binary data

○ : ON ● : OFF

Command position No.	PC256	PC128	PC64	PC32	PC16	PC8	PC4	PC2	PC1
Completed position No.	PM256	PM128	PM64	PM32	PM16	PM8	PM4	PM2	PM1
0	●	●	●	●	●	●	●	●	●
1	●	●	●	●	●	●	●	●	○
2	●	●	●	●	●	●	●	○	●
3	●	●	●	●	●	●	●	○	○
4	●	●	●	●	●	●	○	●	●
5	●	●	●	●	●	●	○	●	○
6	●	●	●	●	●	●	○	○	●
7	●	●	●	●	●	●	○	○	○
8	●	●	●	●	●	○	●	●	●
9	●	●	●	●	●	○	●	●	○
⋮	⋮	⋮	⋮	⋮	⋮	⋮	⋮	⋮	⋮
509	○	○	○	○	○	○	○	●	○
510	○	○	○	○	○	○	○	○	●
511	○	○	○	○	○	○	○	○	○

[Shortcut control of rotary actuator of multi-rotation specification]

(1) Set of shortcut selection

The shortcut selection can be made valid/invalid by Parameter No.80 "shortcut selection during rotation". If the shortcut selection is made valid, the actuator can be moved only in a single direction.

[Operation Examples]

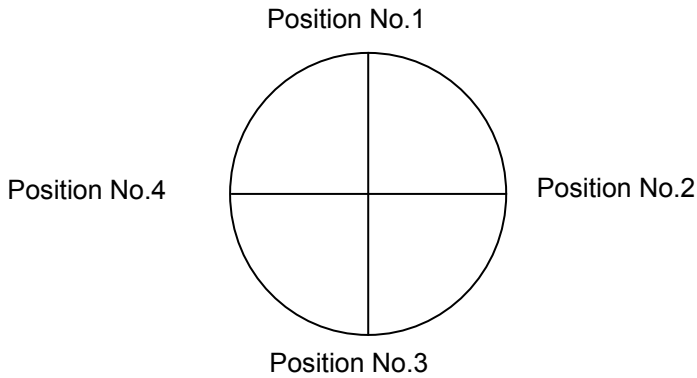

Position No.	Position
1	0
2	90
3	180
4	270

Enter position data assuming 1° = 1mm.
(Example) 1.2 is assumed as 1.2°.

For operation in the order of positions 1→2→3→4→1, the actuator is moved differently whether the shortcut selection is valid or invalid.

- When shortcut selection is invalid:

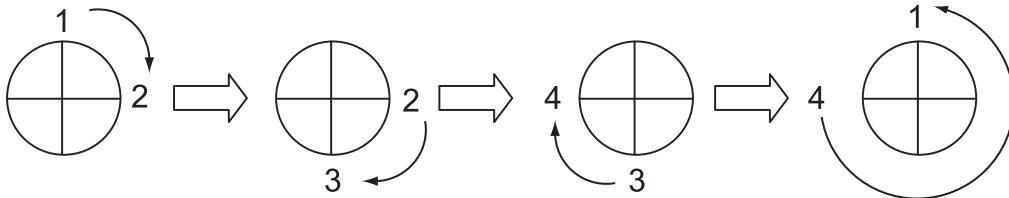

- When shortcut selection is valid:

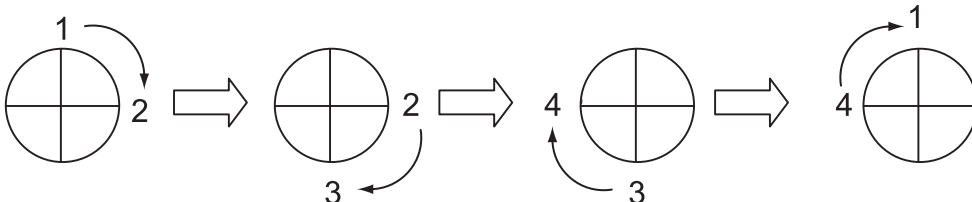

(2) Infinite Rotation Control

Making the shortcut selection valid and moving the actuator in a specific direction continuously allows the actuator to be rotated continuously as a motor. The continuous operation can be done as described below.

[Operation Examples]

This example rotates the actuator by 2 turns and finally stops it at position No.4.

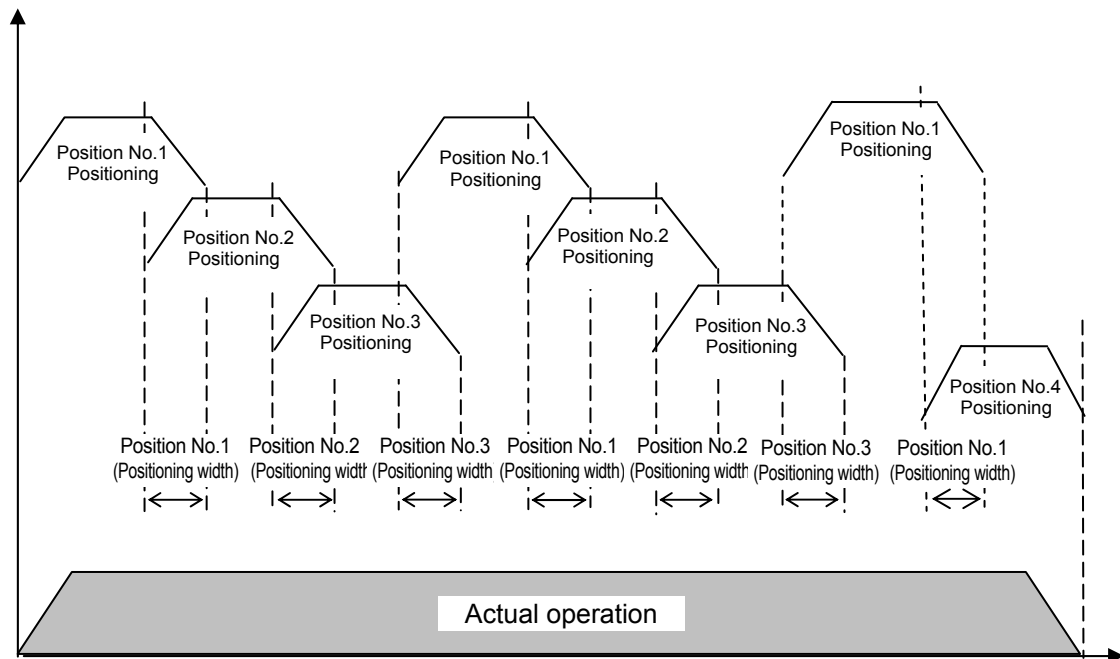
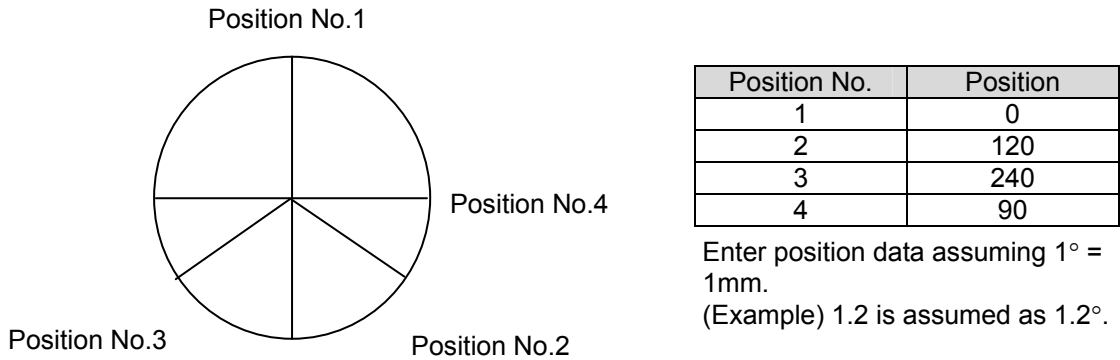

- 1) Widen the positioning widths of position No.1 to 3 so that they are located before the position at which deceleration is started.
- 2) Positioning of position No.1 makes positioning complete signal PENDING turned ON before deceleration is started. If PENDING is turned ON, positioning of position No.2 is executed. Similarly, positioning is repeated in the order of position No.3 → 1 → 2 → 3 → 4. Because the normal positioning always gives position data specified last the highest priority, the actuator can be rotated continuously.
- 3) If the speeds in position No.1 to 4 are set to be the same, the actuator can be rotated at the same speed. Then the actuator is stopped at the positioning set in position No.4. The number of rotations is defined by the number of repeats of position No.1 to 3.

[2] Speed Change During the Movement
 ■ Sample use

■ Liquid injection unit

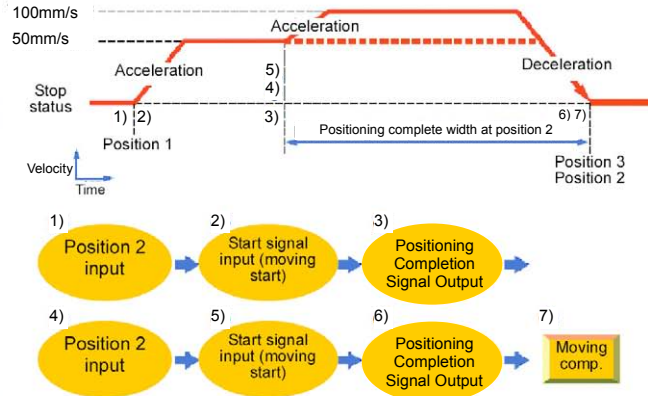
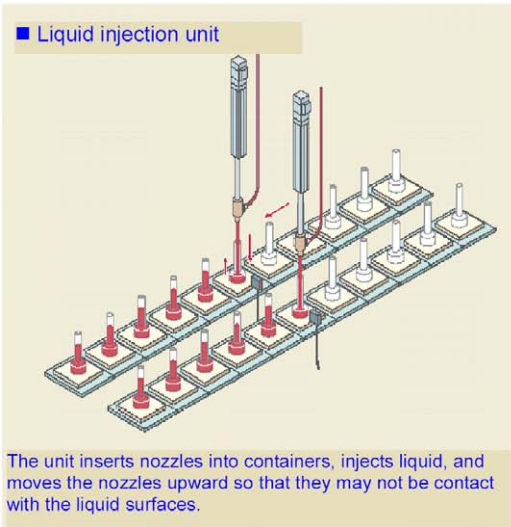

No.	Position [mm]	Velocity [mm/s]	Acceleration [G]	Deceleration [G]	Pressing [%]	Threshold [%]	Positioning width [mm]	Zone+ [mm]	Zone- [mm]	Acceleration/Deceleration mode	Incremental	Transported load	Stop mode
0													
1	150.00	250.00	0.20	0.20	0	0	0.10	0.00	0.00	0	0	0	0
2	0.00	50.00	0.20	0.20	0	0	100.00	0.00	0.00	0	0	0	0
3	0.00	100.00	0.20	0.20	0	0	0.10	0.00	5.00	0	0	0	0

■ Control method

The speed of the actuator can be changed while it moves. Positions are used by the number of speeds. The method of controlling the operation to each position is the same as that described in [1] Positioning.

The example below describes the case of 2 speeds:

- 1) In this example, the speed is changed while the actuator moves from the position of 150mm to the position of 0mm. At first, set the positioning to the target position at the first speed in position No.2. In the positioning width, set the distance from the speed change position to the target position. The value is set to 100mm in the example. Thus, for position No.2, positioning complete signal PEND is turned ON at the position before the target position by 100mm.
- 2) Set the positioning to the target position at the second speed in position No.3.
- 3) Start position No.2. Then start position No.3 successively when PEND in position No.2 is turned ON. In normal positioning, position data specified later has always a priority over position data specified earlier. Thus, the operation in position No.3 is started on the way of the operation in position No.2.

In this example, the target positions No.2 and 3 are equal with each other. They may not be the same. However, setting the target positions to be equal with each other allows the distance from the speed change position to the target position to be known easily.

To increase in the number of speed change steps, add a position number and operation sequence, set the speed change position in the positioning width and operate the actuator continuously.

[3] Pitch Feeding (Relative Movement = Incremental Feed)
 ■ Sample use

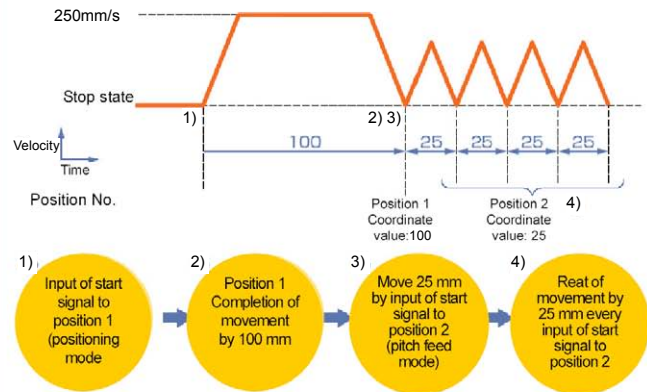
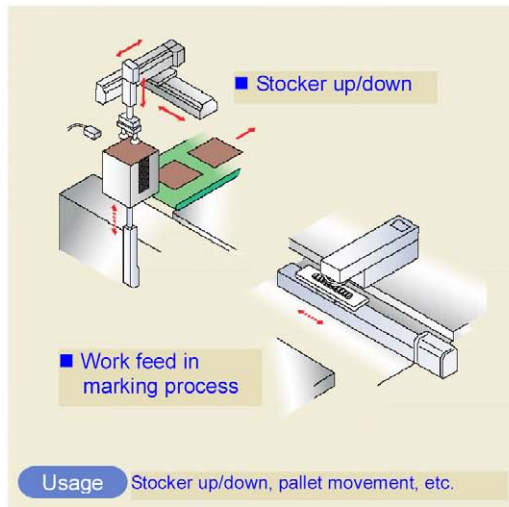

No.	Position [mm]	Velocity [mm/s]	Acceleration [G]	Deceleration [G]	Pressing [%]	Threshold [%]	Positioning width [mm]	Zone+ [mm]	Zone- [mm]	Acceleration/Deceleration mode	Incremental	Transported load	Stop mode
0													
1	100.00	250.00	0.20	0.20	0	0	0.10	0.00	0.00		0	0	0
2	25.00	250.00	0.20	0.20	0	0	0.10	0.00	0.00		1	0	0

(Position No.2 sets pitch feed.)

■ Control method

- 1) The method of controlling pitch feed is the same as that described in [1] Positioning except the setting of the position table. Repeat the positioning of a specific position No. .
- 2) For pitch feed, the position set in the position table indicates the pitch. Set the pitch (relative moving distance = incremental moving distance) in column "Position".
- 3) If the operation command is issued, the actuator moves from the current stop position by "Position" in the position table. To perform continuous movement, repeat the operation. Any accumulation error does not occur because the home position (coordinate value 0) is specified as the base point.

⚠ Caution: In the pitch feed, do not perform a command with a pitch smaller than the minimum encoder resolution (lead/encoder pulse number) or that less than positioning accuracy repeatability. There would be no deviation to occur even with the command because it is an operation command to the same position as the positioning complete condition, but the positioning control cannot be performed properly.

- ⚠ Caution: (1) If the actuator reaches the software limit corresponding to the stroke end in the pitch feed operation, the actuator stops at the position and positioning complete signal PEND is turned ON.
- (2) When it is required to have pitch feed operation straight after pressing operation (condition kept in pressing), it is necessary to be cautious as the actuator moves directly to the coordinates that the pitch feed distance is added to the base point of pitch.

Base point of pitch: the coordinate value entered in "Position" of the pressing position data

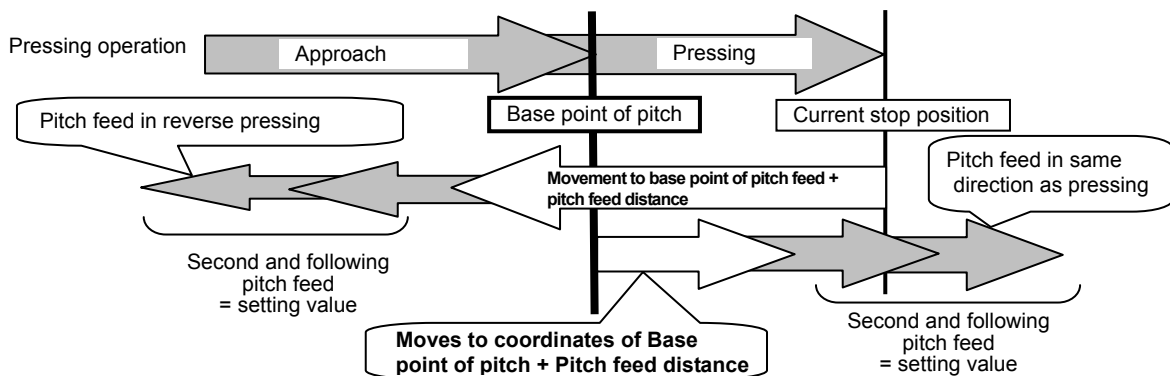

- (3) If the position number for pitch feed is started (CSTR ON) during normal positioning, the actuator moves to the position of the coordinate resulting from adding the pitch feed distance to the target coordinate of the positioning. Repeating the start of pitch feed several times allows the pitch feed distance to be added to the target position by the number of repeats. Do not use the pitch feed function in such a way, because the PLC cannot confirm the complete position.
- (4) Note that, if pitch feed is started (CSTR ON) repeatedly during pause, the actuator moves continuously by the distance based on the number of starts. In such a case, cancel the remaining moving distance by turning reset signal RES to ON in the pause state or take interlock so that the start signal is not turned ON during pause.
- (5) At software limit (stroke end) in pitch feed, the actuator is decelerated to be stopped and positioning complete output PEND is output.
- (6) MOVE is turned ON as soon as PEND is turned OFF and turned ON as soon as PEND is turned ON. Accordingly, with a large positioning width being set, MOVE may be turned OFF while the actuator is moved.
- (7) Pressing is enabled by using the pitch feed function. However, do not make control of changing to pitch feed on the way of normal positioning (before PEND turning ON). Pressing is interrupted by using the pitch feed function as soon as start signal CSTR is turned ON. The PLC cannot manage the position of the actuator any more.

[4] Pressing Operation
 ■ Sample use

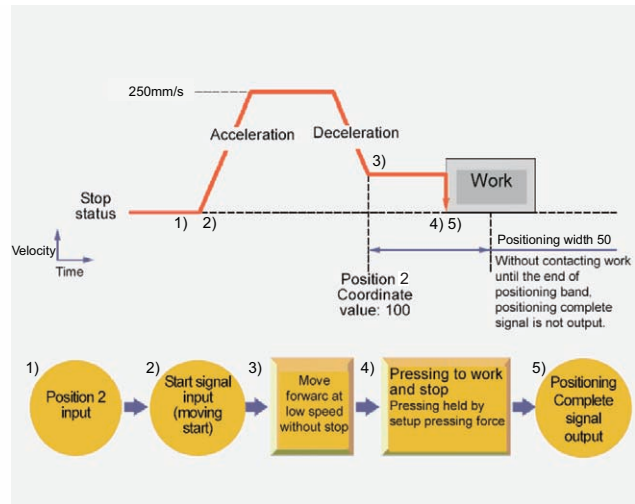
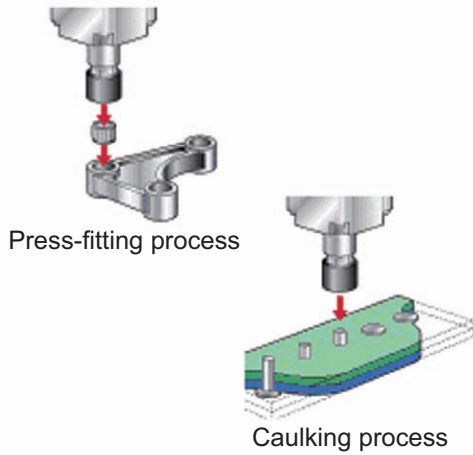

No.	Position [mm]	Velocity [mm/s]	Acceleration [G]	Deceleration [G]	Pressing [%]	Threshold [%]	Positioning width [mm]	Zone+ [mm]	Zone- [mm]	Acceleration/Deceleration mode	Incremental	Transported load	Stop mode
0													
1	0.00	250.00	0.20	0.20	0	0	0.10	0.00	0.00	0	0	0	0
2	100.00	250.00	0.20	0.20	50	0	50.00	0.00	0.00	0	0	0	0

(Position No.2 sets pressing operation.)

■ Control method

- 1) The method of controlling the pressing operation is the same as that described in [1] Positioning except the setting of the position table. Any setting of “Pressing” in the position table allows the pressing operation to be done. “Positioning width” is assumed as pressing operation distance.
- 2) The actuator moves at the setting speed and rating torque to the position of the coordinate set in “Position” in the similar way as normal positioning. Then the operation changes to pressing. The moving distance in pressing is the value set in “Positioning width”. The pressing is performed with the torque (current limit value) set in percent in “Pressing” of PIO patterns 0 to 3 being the upper limit.
- 3) The control method is the same as that in [1] Positioning. However, the processing of positioning complete signal PEND is different from that in [1] Positioning. PEND is output when the shaft is stopped by pressing (pressing complete). If the work is not subject to pressing (miss-pressing), the actuator moves by the value set in “Positioning width” to stop but PEND is not turned ON.

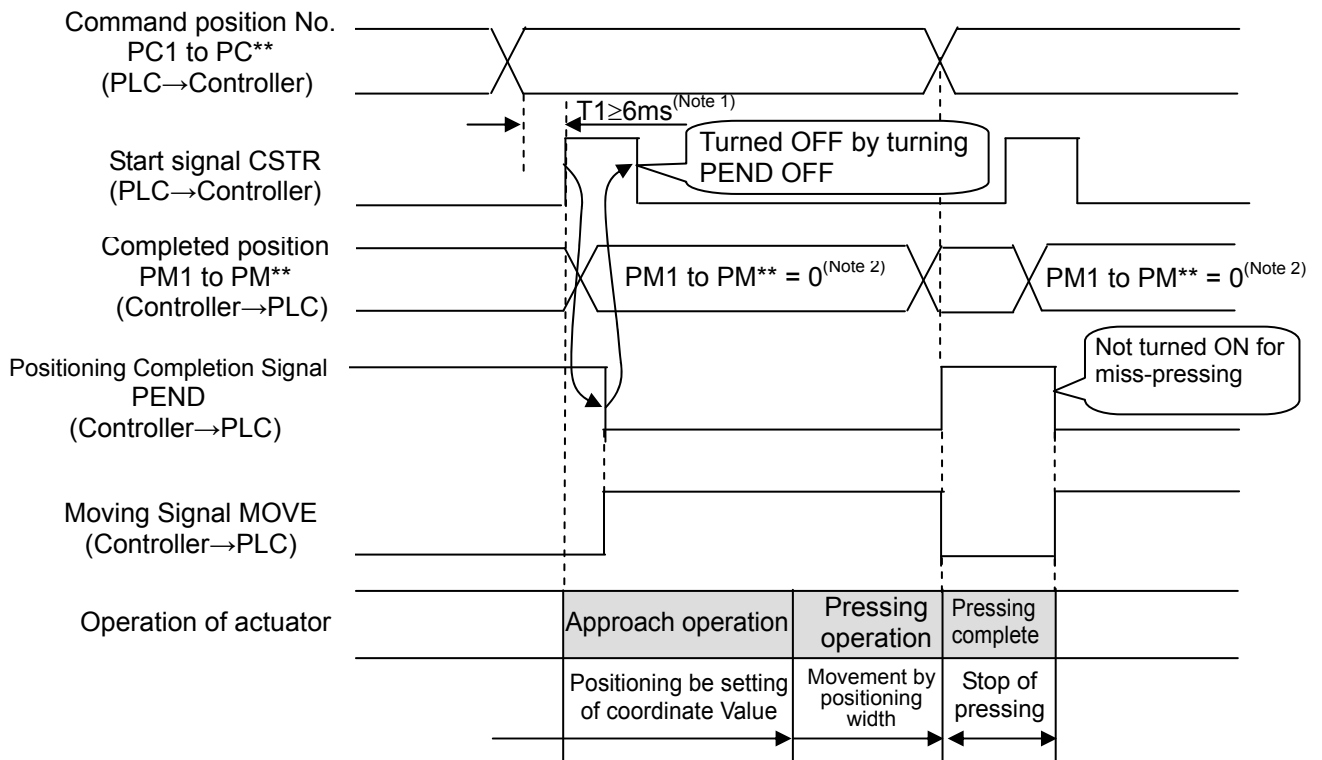

- Note 1 Set the period taken from entering the position number to turning CSTR ON to 6ms or longer. Because 6ms timer process on the PLC is also entered to the controller, positioning at another position may occur. Take the PLC scan time into account.
- Note 2 The completion position No. output is set to 0 during movement of the actuator.

⚠ Caution: (1) The speed during pressing operation is set in Parameter No.34. Check the 9.6 List of Specifications of Connectable Actuators for the pressing operation speed.

Do not set any value larger than the value in the list. If the speed set in the position table is equal to or less than the pressing speed, the pressing is performed at the setup speed.

- (2) The approach start position of pressing should be located at or before the pressing start position (coordinate 100mm or less in the above example) If not, the moving direction varies depending on the start position to be dangerous.

For example, pressing at coordinate larger than the pressing end position (larger than 150mm) is performed in the direction from the current position to the pressing end position. Note that pressing after positioning to the position of coordinate 100mm does not take place.

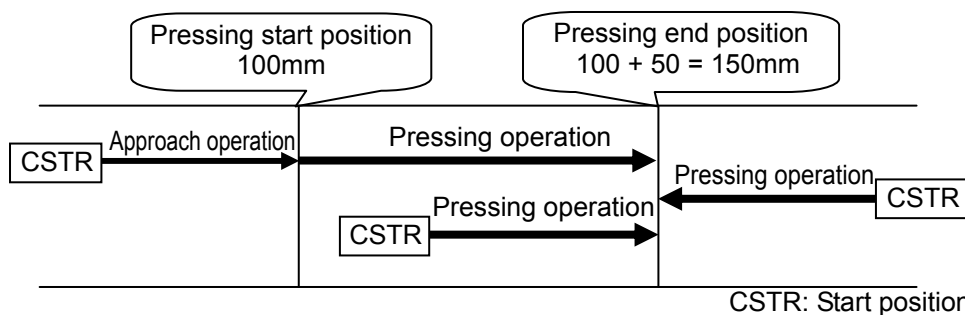

- (3) The work is pressed after the pressing is completed. The work may moves backward or forward. If the actuator is moved backward before the approach position, alarm code 0DC "Pressing motion range over error" occurs to stop the actuator. In movement of the work in the pressing direction, PEND is turned OFF if the load current becomes lower than the current limit (pressing (%)). Miss-pressing occurs when the actuator moves by the pressing moving distance set in "Positioning width".
- (4) Do not make control of changing to pressing on the way of normal positioning (before PEND turning ON). Depending on the position at which start signal CSTR is turned ON, the pressing is performed improperly. Then the PLC cannot manage the position of the actuator.
- (5) Pressing control cannot be performed with the rotary actuator. If the index mode is selected for the rotary actuator of multi-rotation specification, pressing operation cannot be set. The positioning complete signal PEND is turned ON when the actuator reaches the positioning width.
- (6) If the actuator gets pressed to the work during the approach operation, error would be issued.

Judging completion of pressing operation

The operation monitors the torque (current limit value) in percent in "Pressing" of the position table and turns pressing complete signal PEND ON when the load current satisfies the condition shown below during pressing. PEND is turned ON at satisfaction of the condition if the work is not stopped.

$$\begin{aligned}
 & \text{(Accumulated time in which current reaches pressing value [\%])} \\
 & - \text{(accumulated time in which current is less than pressing value [\%])} \\
 & \geq 255 \text{ ms (Parameter No.6)}
 \end{aligned}$$

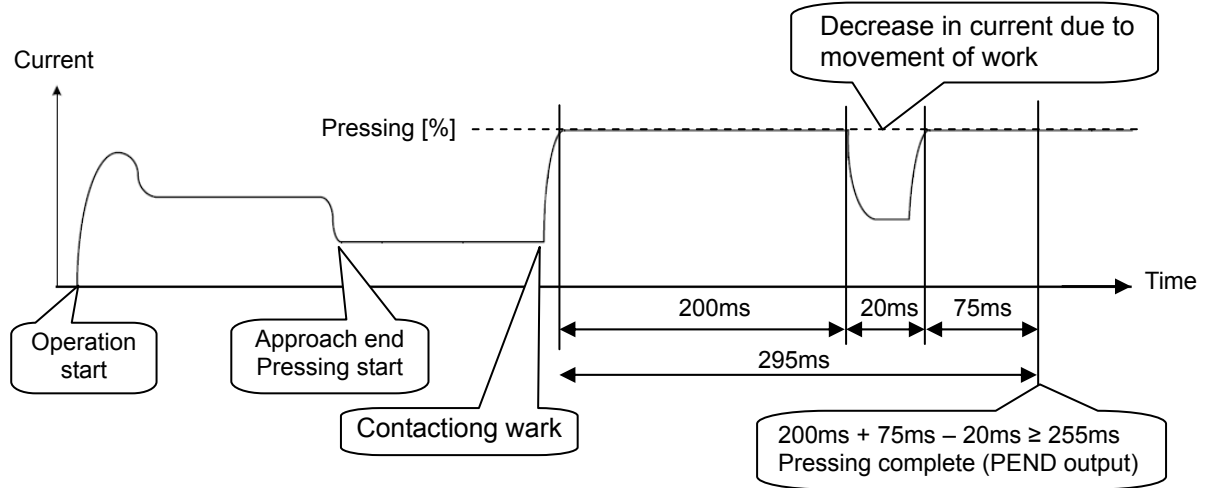

Command Torque Level Detection at Pressing

It is the signal dedicated for High-Thrust Actuator (CFB type). Use this as a reference output for other actuators.

This is a function to detect whether the specified load is applied to the actuator by checking the torque while in press-fitting operation when having a press-fitting process with the pressing operation. If there is no resistance in press-fitting, the specified load would not be applied, thus it is defined as the normal pressing is not conducted and an alarm can be issued from PLC.

Load Output Judgment Status (LOAD) Signal ^(Note 1) turns ON when the pressing current exceeds the value [%] set as the "threshold" of the position data in the pressing operation range (except for approach operation range) and in the range set as the "position zone" in the position data for the duration of judgment time ^(Note 2) or longer. It will not turn OFF even if the load has been removed and the current has dropped. It turns OFF at next movement command or alarm reset.

Torque Level Status (TRQS) Signal ^(Note 1) turns ON when the pressing current exceeds the value [%] set as the "threshold" of the position data in the pressing operation range (except for approach operation range) for the duration of judgment time ^(Note 2) or longer. It turns OFF once it has been confirmed that the load has been removed and the current has dropped.

Note 1 It should be switched to LOAD Signal with "0" set in Parameter No. 51 "Torque inspected range" and TRQS Signal with "1" set in the parameter.

Note 2 Establish the setting in Parameter No.50 "Load Output Judgment Time." (Initial setting: 255ms)

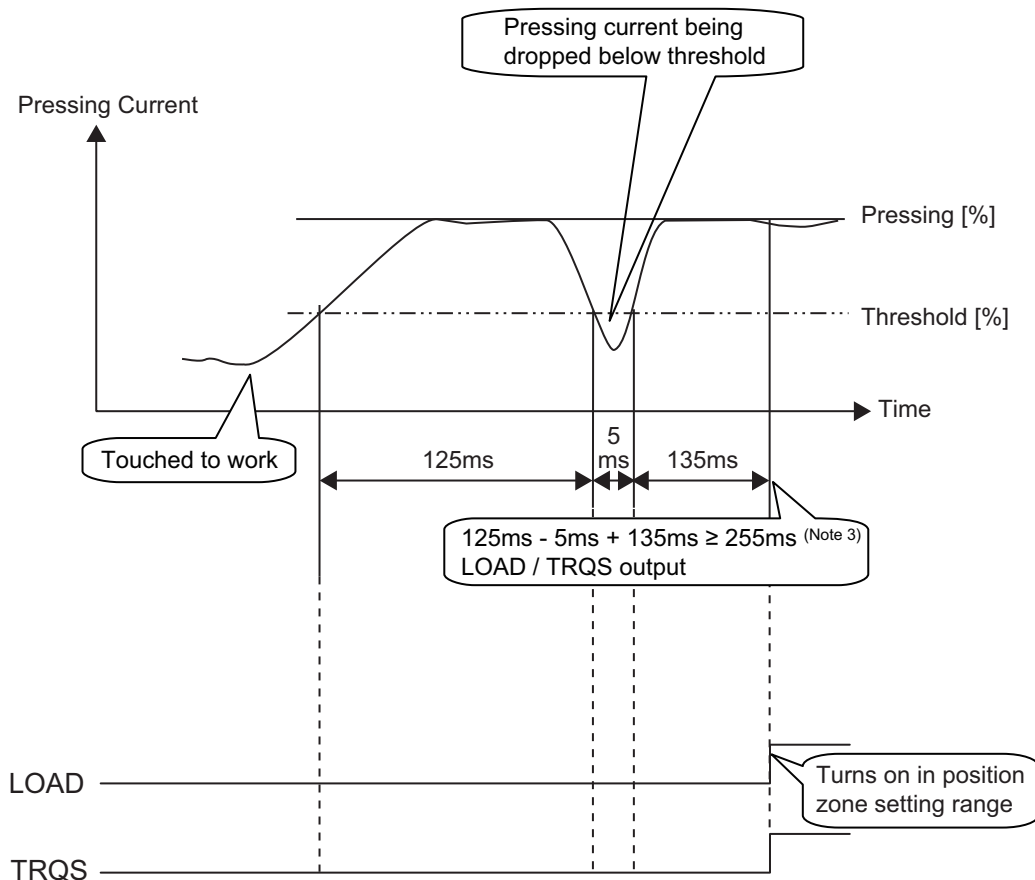

Note 3 (Total time of pressing current to reach above threshold) – (Total time of pressing current to get below threshold) ≥ 255ms (Parameter No. 50)

[5] Tension Operation

■ Image diagram

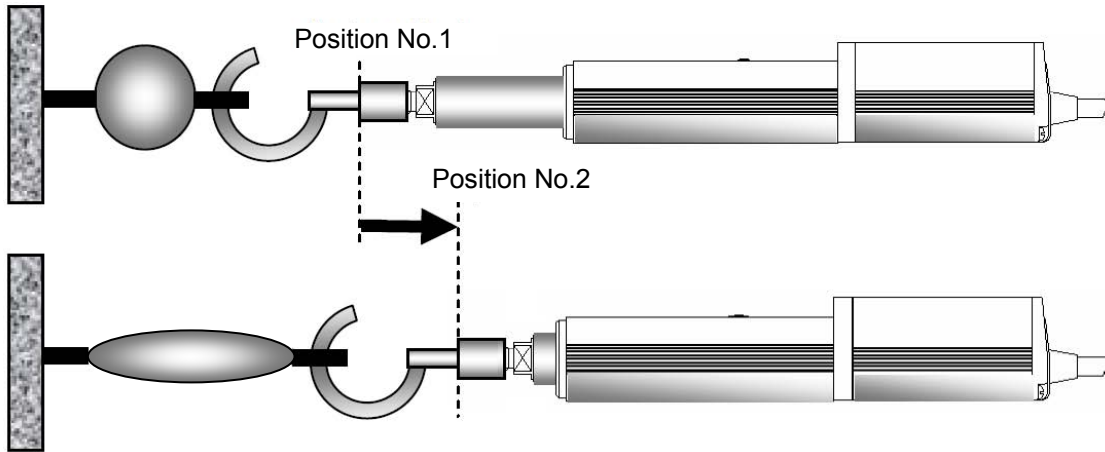

No.	Position [mm]	Velocity [mm/s]	Acceleration [G]	Deceleration [G]	Pressing [%]	Threshold [%]	Positioning width [mm]	Zone+ [mm]	Zone- [mm]	Acceleration/Deceleration mode	Incremental	Transported load	Stop mode
0													
1	100.00	250.00	0.20	0.20	0	0	0.10	0.00	0.00	0	0	0	0
2	80.00	250.00	0.20	0.20	50	0	-50.00	0.00	0.00	0	0	0	0
3													

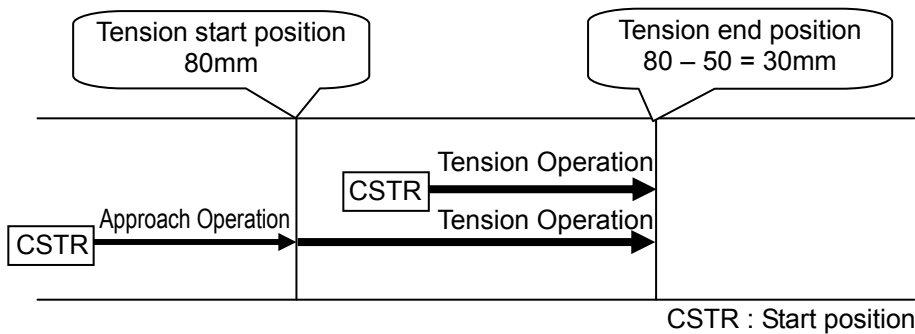

■ Control method

The method of controlling the tension operation is the same as that described in [4] Pressing operation. The control method is explained below by using the sample position table shown above.

- 1) Position No.2 indicates the settings of tension operation. The settings of "Position" and "Positioning width" show the tension start position and the tension quantity, respectively. Attach - (minus sign) to the tension quantity. Specify the upper limit of the torque required for tension in percent (limited current value) in "Pressing". The speed, acceleration, and deceleration are the conditions of positioning to the coordinate value (80mm) set in "Position".
- 2) Position No.1 indicates the tension start preparation position. Specify a value larger than the coordinate value at which the tension provided by position No.2 ends (80 - 50 = 30mm) in "Position".

- 3) First define the positioning in position No.1. Next, the operation in position No.2 moves the actuator to the position of 80mm at the setting speed and rating torque and change to the tension operation. The actuator moves by 50mm in the negative direction in the tension operation. The upper limit of the tensile force is the torque set in percent.
- 4) In the similar way as pressing, the positioning complete signal is output when the shaft is stopped by tension (pressing complete). If the actuator cannot be stopped during movement within the setting positioning width (miss-pressing), it moves by the setting distance to stop but PEND is not turned ON.

⚠ Caution: (1) The speed during tension operation is set in Parameter No.34. Check the 9.6 List of Specifications of Connectable Actuators for the pressing speed. The speed for pulling operation is same as that for pressing operation. Do not set any value larger than the value in the list. If the speed set in the position table is equal to or less than the tension speed, the tension operation is performed at the setup speed.

(2) The tension ready position should be the tension start position or forward. If not, the moving direction varies depending on the start position to be dangerous.
The tension operation from a coordinate (less than 30mm = 80 – 50) located before the end position (30mm) changes to the pressing operation from the current position to the tension end position. Note that the tension operation after positioning to the position of 80mm does not take place.

CSTR: Start position

(3) The work is pulled also after completion of the tension. The work is drawn back or pulled further if the work is moved. When the work is drawn back before the approach position, alarm code 0DC “pressing operation range error” occurs to stop the work. When the work is moved in the tension direction and the load current becomes less than the current limit value (pressing in percent), PEND is turned OFF. Naturally, the work reaches the tension moving distance set in “Positioning width” to cause miss-pressing.

(4) Do not make control of changing to tension operation on the way of normal positioning (before PEND turning ON). Depending on the position at which start signal is turned ON, the tension operation is performed improperly. Then the PLC cannot manage the position of the actuator.

(5) Pulling operation cannot be performed with the rotary actuator.

Command Torque Level Detection at Pulling

It is available to use in the same manner as for pressing. [Refer to Pressing Operation in 3.2.4 [4] Position Number Input Operation = PIO Pattern 0 to 3.]

[6] Multi-step Pressing
 ■ Image diagram

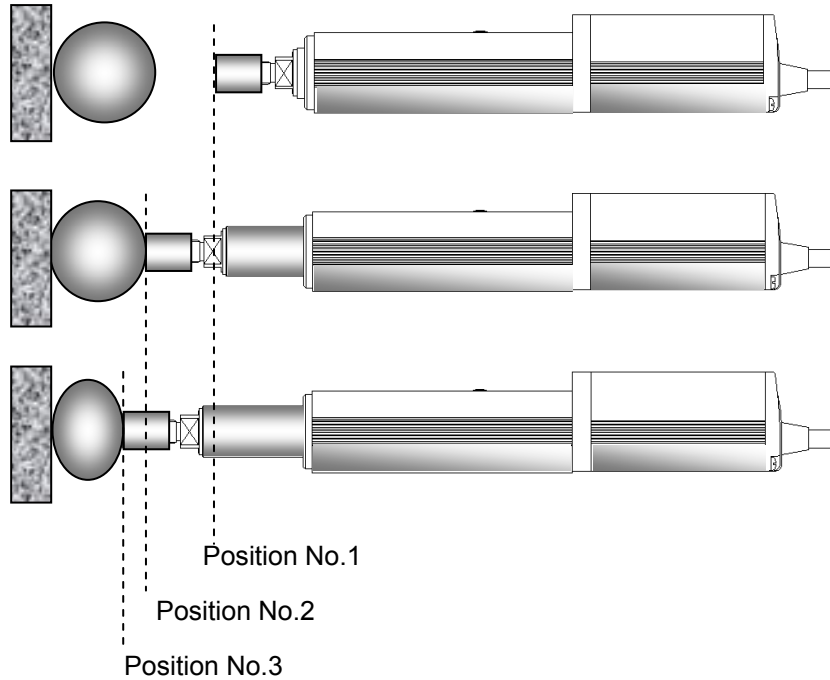

No.	Position [mm]	Velocity [mm/s]	Acceleration [G]	Deceleration [G]	Pressing [%]	Threshold [%]	Positioning width [mm]	Zone+ [mm]	Zone- [mm]	Acceleration/Deceleration mode	Incremental	Transported load	Stop mode
0													
1	0.00	250.00	0.20	0.20	0	0	0.10	0.00	0.00	0	0	0	0
2	50.00	250.00	0.20	0.20	30	0	20.00	0.00	0.00	0	0	0	0
3	50.00	250.00	0.20	0.20	50	0	20.00	0.00	0.00	0	0	0	0
4													

■ Control method

After pressing, the pressing pressure can only be changed in the pressing state. The method of controlling multi-step pressing is the same as that described in [4] Pressing operation.

- 1) Set the weak pressing (30%) in position No.2 and perform the pressing operation.
- 2) If pressing complete signal PEND is turned ON, start the pressing operation with pressing pressure (50%) greater than the first pressure set in position No.3. The position data in position No.3 should be the same as that in position No.2 except the setting in "Pressing".
- 3) To add a pressing step with another pressing pressure, add a sequence consisting of a position number and a pressing operation.

[7] Teaching by PIO (MODE, MODES, PWRT, WEND, JISL, JOG+, JOG-)

PIO signal	Input					Output	
	MODE	JISL	JOG+	JOG-	PWRT	MODES	WEND
Other than pattern 1	×	×	×	×	×	×	×
Pattern 1	○	○	○	○	○	○	○

○: Existence of signal, ×: No signal

(Note) The feature is available only in pattern 1.

Teaching by PIO is enabled.

It is possible to select the teaching mode, move the actuator to the target position with jog or inching operation, and write the coordinate value into any position number.

(1) Teaching Mode Selecting

- 1) To select the teaching mode, set teaching mode signal MODE to ON. If the teaching mode is selected, mode status signal MODES is turned ON.
 - While the actuator is operating, MODE signal input is invalid. Therefore, after the operation is completed, the MODES signal is turned ON.
 - With the MODES signal being ON, the CSTR signal is changed to teaching signal PWRT. Therefore, it is not possible to operate the actuator by specifying a position No.
- 2) To cancel the teaching mode to return to the normal operation mode, set the MODE signal to OFF. If the MODE signal is turned OFF, the MODES signal is turned OFF to return to the normal operation mode.

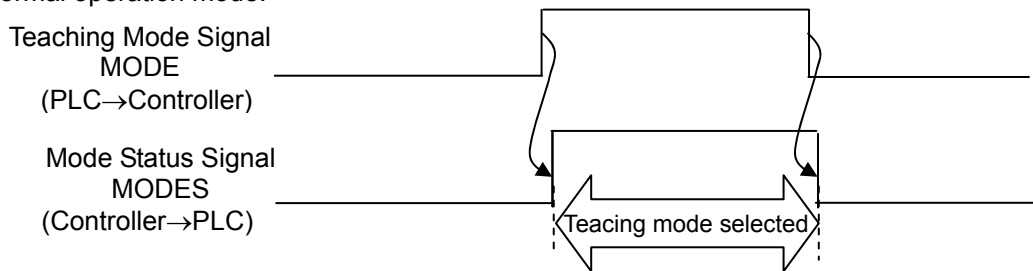

(2) Jog/inching switch and jog input

- 1) Jog/inching switching signal JISL indicates whether the jog operation^{*1} or inching operation^{*2} is performed by the jog input signal.
 - JISL signal OFF: Jog operation
 - JISL signal ON: Inching operation
- 2) There are two jog input signals, or JOG+ for operation in the positive direction and JOG- for operation in the negative direction.

*1 Jog operation: The actuator is moved while the jog input signal is set to ON.

- JOG+ While JOG+ is set to ON, the actuator is moved in the positive direction. If JOG+ is turned OFF, the actuator is decelerated and then stopped.
- JOG- While JOG- is set to ON, the actuator is moved in the negative direction. If JOG- is turned OFF, the actuator is decelerated and then stopped.
- Velocity Value set in Parameter No.26 "PIO jog velocity".
- Acceleration/Deceleration Rating acceleration/deceleration of actuator
- Pause Signal *STP Enabled

*2 Inching operation: Once the jog input signal is turned ON, the actuator is moved by a certain distance.

- JOG+ Once JOG+ is turned ON, the actuator is moved by a certain distance in the positive direction.
- JOG- Once JOG- is turned ON, the actuator is moved by a certain distance in the negative direction.
- Moving distance Value set in Parameter No.48 "PIO inching distance".
- Velocity Value set in Parameter No.26 "PIO jog velocity".
- Acceleration/Deceleration Rating acceleration/deceleration of actuator
- Pause Signal *STP Enabled

Warning: (1) In home return incomplete state, software limit cannot stop the actuator. Take interlock and prohibit the operation or perform the operation carefully.
 (2) If the JISL signal is changed during inching operation, the inching being operated is continued. If JISL is changed during job operation, the jog is stopped.

(3) Writing current data to position table

- 1) The feature is valid only when the teaching mode is selected (with the MODES signal being ON).
- 2) Specify the position number to which the current data is written in the binary data format in command position No.PC1 to PC32. Turn current value writing signal PWRT ON.
- 3) The coordinate value of the current position is written into the position table for the controller.
 If position data is written previously, only the coordinate value in "Position" is only rewritten. If nothing is written, the values set in the parameters below are written as the speed, acceleration/deceleration, positioning width, acceleration/deceleration mode and stop mode. Other data is set to "0".
 - Velocity Parameter No.8 "Default speed"
 - Acceleration Parameter No.9 "Default acceleration/deceleration"
 - Deceleration Parameter No.9 "Default acceleration/deceleration"
 - Positioning width Parameter No.10 "Default positioning width (in-position)"
 - Acceleration/deceleration mode .. Parameter No.52 "Default acceleration/deceleration mode"
 - Stop mode Parameter No.53 "Default stop mode"
- 4) At the completion of writing, controller write complete signal WEND is output. Then turn the PWRT signal OFF.
- 5) When the PWRT signal is turned "OFF" the WEND signal is also turned "OFF".
 Turn OFF PWRT after confirming WEND is turned ON.
 Turning it OFF before turning ON disturbs the proper data writing.

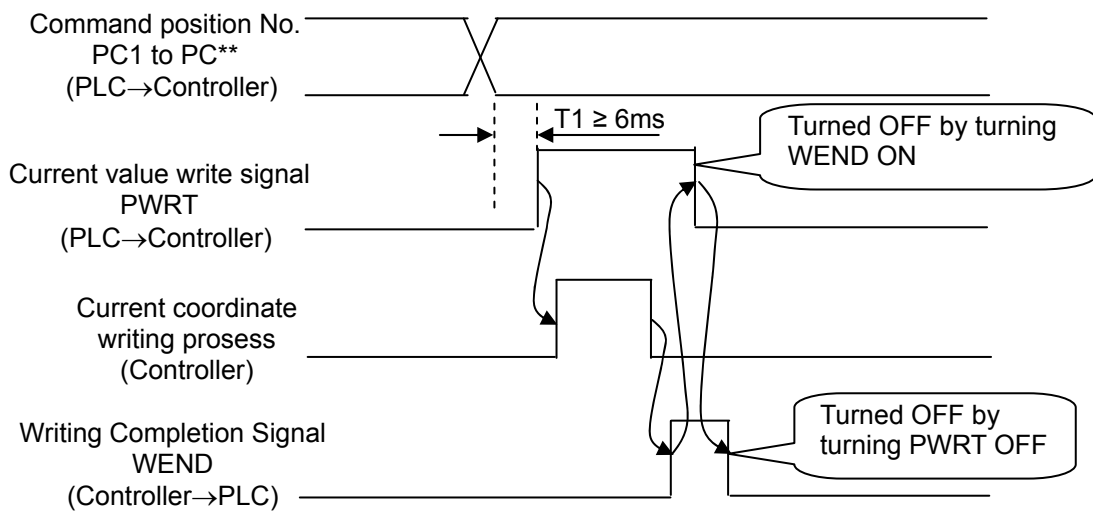

⚠ Caution:

- (1) Set the period taken from entering position No. to turning the PWRT ON to 6ms or longer. In spite of 6ms timer process in the PLC, commands may be input to the controller concurrently to cause writing to another position. Take the scanning time in the PLC into account, set a period as 2 to 4 times as the scanning time.
- (2) Turning the PWRT signal ON in the state in which home return is not completed (the HEND signal is set to ON) causes alarm 093 "PWRT signal detected before completion of home return" to occur.
- (3) Turning PWRT signal OFF before turning WEND signal ON disturbs the proper data writing.
- (4) Writing processing with position table screen remaining open on a teaching tool such as PC software cannot lead the data on the screen to be updated. To update and confirm writing data, take the following actions:
 - 1) PC software Left-click the  button.
 - 2) Teaching Pendant Change to user adjustment screen, input "4" in adjustment N O and return to the position table screen after software reset.

Check the relevant Instruction Manual for details of operation.

[8] Pause and Operation Interruption (*STP, RES, PEND, MOVE)

PIO signal	Input		Output	
	*STP	RES	PEND	MOVE
Pattern 0 to 1	○	○	○	○
Pattern 2 to 3	○	○	○	×

○: Existence of signal, ×: No signal

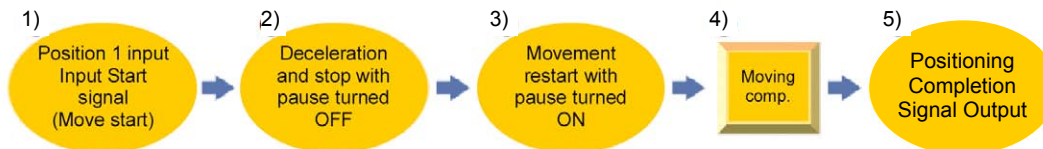
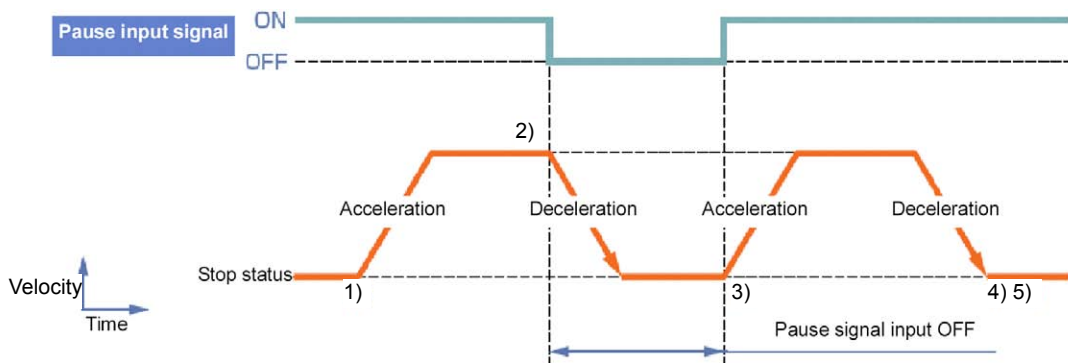

■ Control method

Pause is possible during movement. In addition, the remaining moving distance can be cancelled to interrupt the operation.

The pause signal is an input signal always set to ON. So, it is normally used to remain ON. Use this function for interlock in case where an object is invaded into the moving direction of the actuator being moved.

- 1) If pause signal *STP is turned off during operation of the actuator, the actuator is decelerated to a stop. The deceleration is defined by the value set in the position table.
- 2) During pause, moving signal MOVE is set to OFF but positioning complete signal PEND is not turned ON.
- 3) If pause signal *STP is returned to ON, the actuator continues the remaining movement. The acceleration is the value set in the position table.
- 4) Turning reset signal RES ON during pause (*STP being OFF) allows the remaining movement to be cancelled to interrupt the operation.

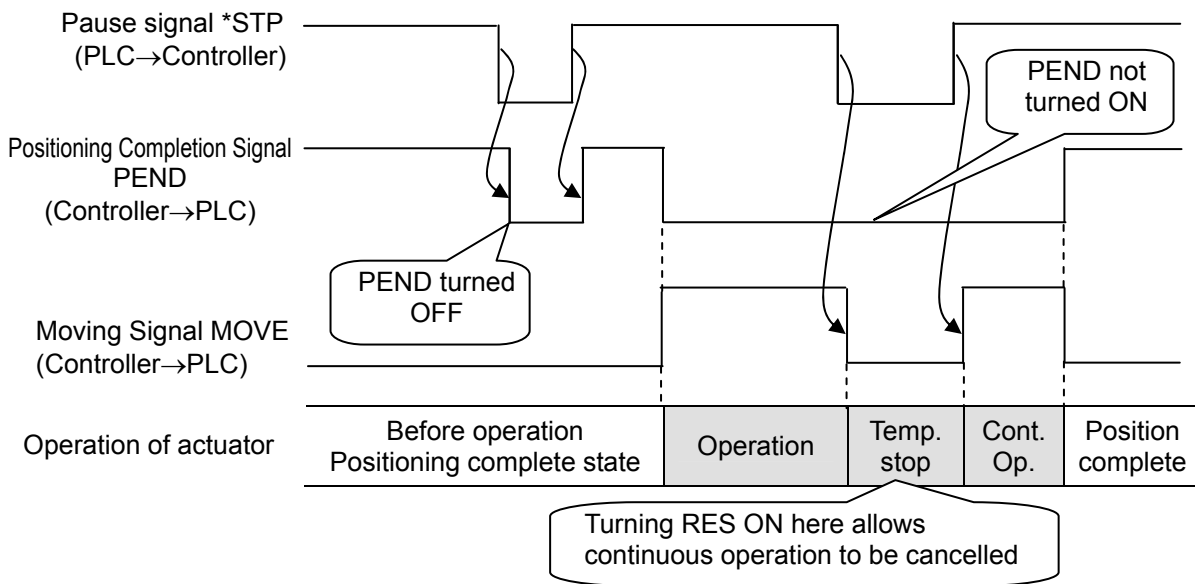

⚠ Caution: (1) At occurrence of an alarm in the release level^(Note 1), RES can reset the alarm. Cancel the remaining moving distance after confirmation that alarm signal *ALM (being ON in normal state and OFF at occurrence of an alarm) is set to ON.
 Note 1: Check the 8.4 Alarm List for details of alarms.

(2) Turning *STP OFF with the actuator being in the positioning complete state causes PEND to be turned OFF. Note that this situation may not occur when a sequence program is created.

3.2.5 Direct Position Specification (Solenoid Valve Mode 1) = Operation of PIO Pattern 4

The start signal is provided for every position number. Only turning ON the relevant input signal according to the table shown below allows the operation based on the data in the target position number to be performed. The operation mode is called the solenoid valve mode because solenoid valves can directly drive air cylinders.

At the completion of positioning, every completed position number is output as well as the positioning complete signal.

Positioning, pressing, and pitch feed are possible. Their control methods are the same as those of other patterns.

[1] Positioning [Basic] (ST0 to ST6, PE0 to PE6, PEND)

Position No.	Input	Output	
0	ST0	PE0	PEND
1	ST1	PE1	PEND
2	ST2	PE2	PEND
3	ST3	PE3	PEND
4	ST4	PE4	PEND
5	ST5	PE5	PEND
6	ST6	PE6	PEND

- (Note)
- Speed change is not allowed during movement.
 - For incremental type, if start signal ST* is issued without home return, the home return operation is automatically done before the operation based on the data of the specified position number. When this specification is not desired, interlock by home return complete signal HEND is required.
 - In the battery-less absolute or simple absolute type, if it gets into a condition that the home-return operation is incomplete due to such a reason as a parameter change, operation to the indicated position number would not be performed, but only the home-return operation should be performed.

■ Sample use

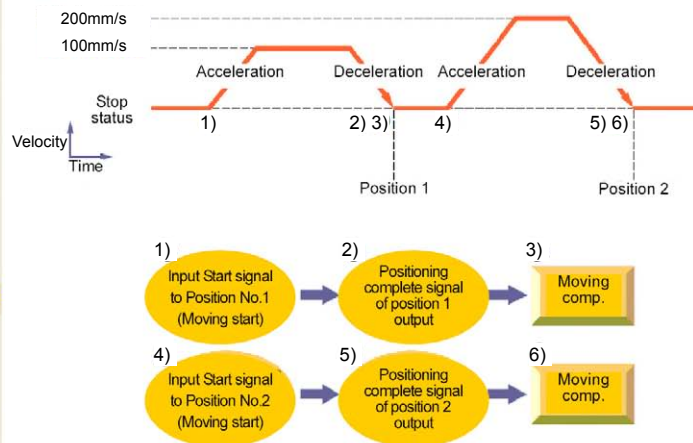
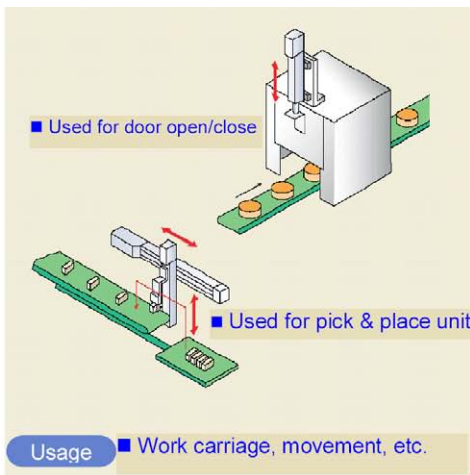

No.	Position [mm]	Velocity [mm/s]	Acceleration [G]	Deceleration [G]	Pressing [%]	Threshold [%]	Positioning width [mm]	Zone+ [mm]	Zone- [mm]	Acceleration/Deceleration mode	Incremental	Transported load	Stop mode
0	0.00	100.00	0.20	0.20	0	0	0.10	0.00	0.00	0	0	0	0
1	70.00	100.00	0.20	0.20	0	0	0.10	0.00	0.00	0	0	0	0
2	150.00	200.00	0.20	0.20	0	0	0.10	0.00	0.00	0	0	0	0

■ Control method

- 1) When start signal ST* is turned ON, the actuator starts acceleration based on the data in the specified position table for positioning to the target position.
- 2) At the completion of positioning, positioning complete signal PEND is turned ON as well as current position No. PE* of the specified position.
- 3) After PEND is turned ON, turn the ST* signal OFF.
- 4) Current position No. PE* and positioning completion signal PEND are turned ON if the remaining moving distance is entered into the positioning width zone. The current position number PE* and PEND Signal will be kept ON once it is turned ON unless the start signal ST* is turned back ON, servo is turned OFF or the actuator is out of the positioning band width range. When the pause signal *STP is turned OFF in this condition, the current position number PE* and PEND Signal will also be turned OFF.

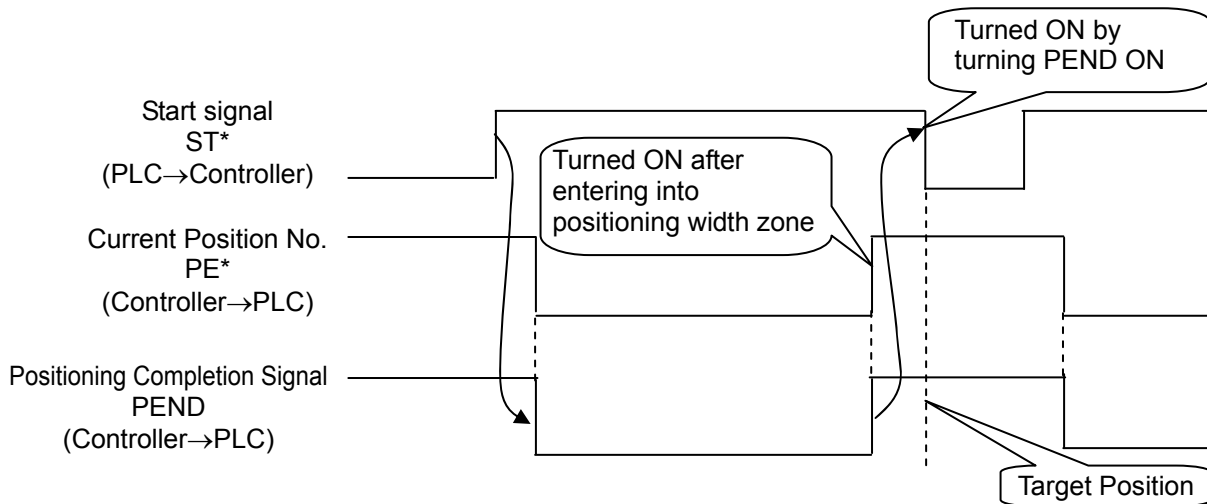

⚠ Caution:

- (1) If the ST* signal is turned ON for the position after completion of positioning, both the PE* and PEND signals remain ON (except the pitch feed operation).
- (2) Both the PE* and PEND signals are set to ON in the positioning width zone. Accordingly, they may be turned ON under operation of the actuator if a large positioning width is set.
- (3) Interlock should be taken so that two or more ST* signals are set to ON simultaneously.
 - 1) Entering the ST* signal of another position during positioning is invalid. If the ST* signal of another position is turned ON during positioning, the operation is terminated after the completion of the positioning being operated.
 - 2) Entering the ST* signal of another position with the ST* signal of the current position remaining ON after the completion of positioning allows the positioning to the other position to be executed.
- (4) If Parameter No.27 "Move command type" is set to "0" (factory setting), turning ST* OFF during positioning caused the operation to be interrupted.

[2] Pitch Feeding (Relative Movement = Incremental Feed)
 ■ Sample use

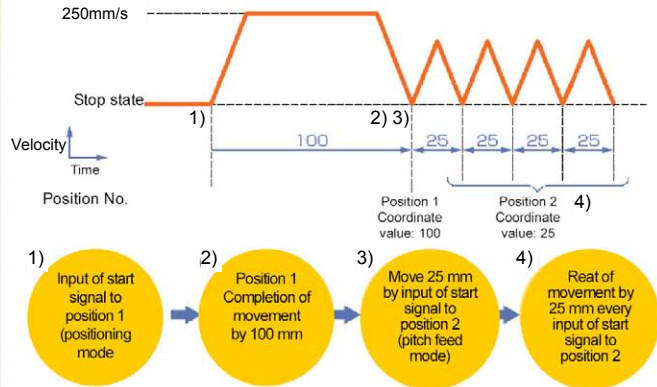
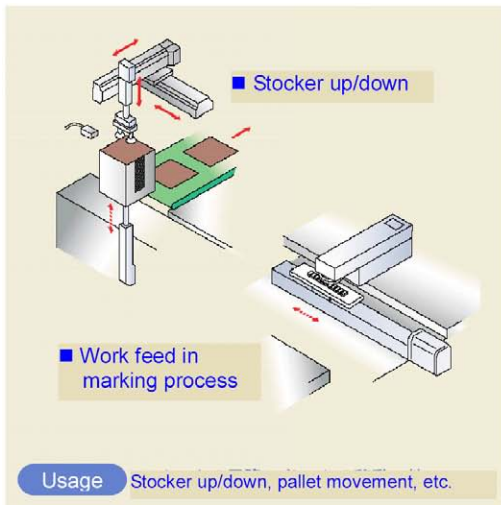

No.	Position [mm]	Velocity [mm/s]	Acceleration [G]	Deceleration [G]	Pressing [%]	Threshold [%]	Positioning width [mm]	Zone+ [mm]	Zone- [mm]	Acceleration/Deceleration mode	Incremental	Transported load	Stop mode
0													
1	100.00	250.00	0.20	0.20	0	0	0.10	0.00	0.00	0	0	0	0
2	25.00	250.00	0.20	0.20	0	0	0.10	0.00	0.00	0	1	0	0

(Position No.2 sets pitch feed.)

■ Control method

- 1) The method of controlling pitch feed is the same as that described in [1] Positioning except the setting of the position table. Repeat the positioning of a specific position No.
- 2) For pitch feed, the position set in the position table indicates the pitch. Set the pitch (relative moving distance = incremental moving distance) in column "Position".
- 3) If the operation command is issued, the actuator moves from the current stop position by "Position" in the position table. To perform continuous movement, repeat the operation. Any accumulation error does not occur because the home position (coordinate value 0) is specified as the base point.

**Caution:**

- (1) Because pitch feed is repeated, turning ON the ST* signal of the same position after completion of positioning causes both the PE* and PEND signals to be turned OFF at operation start and turned ON again at completion of positioning in the same way as [1] Positioning.
- (2) If the actuator reaches the software limit (stroke end) in pitch feed, the actuator is decelerated to be stopped and current position No. PE* and positioning complete signal PEND are turned ON at the stop position.
- (3) Both the PE* and PEND signals are set to ON in the positioning width zone. Accordingly, they may be turned ON under operation of the actuator if a large positioning width is set.
- (4) Interlock should be taken so that two or more ST* signals are set to ON simultaneously.
 - 1) Entering the ST* signal of another position during positioning is invalid. If the ST* signal of another position is turned ON during positioning, the operation is terminated after the completion of the positioning being operated.
 - 2) Entering the ST* signal of another position with the ST* signal of the current position remaining ON after the completion of positioning allows the positioning to the other position to be executed.
- (5) If Parameter No.27 "Move command type" is set to "0" (factory setting), turning ST* OFF during positioning caused the operation to be interrupted.
- (6) Note that, when Parameter No.27 "Move command type" is set to "1", starting (ST* ON) pitch feed repeatedly during pause causes the actuator to be moved successively by the number of starts. If this situation is supposed, cancel the remaining moving distance by turning reset signal RES ON in the pause state or take interlock so that start signals are not turned on during pause.
- (7) The pressing operation is enabled by using the pitch feed function.
- (8) In the pitch feed, do not perform a command with a pitch smaller than the minimum encoder resolution (lead/encoder pulse number) or that less than positioning accuracy repeatability.

There would be no deviation to occur even with the command because it is an operation command to the same position as the positioning complete condition, but the positioning control cannot be performed properly.

[3] Pressing Operation

■ Sample use

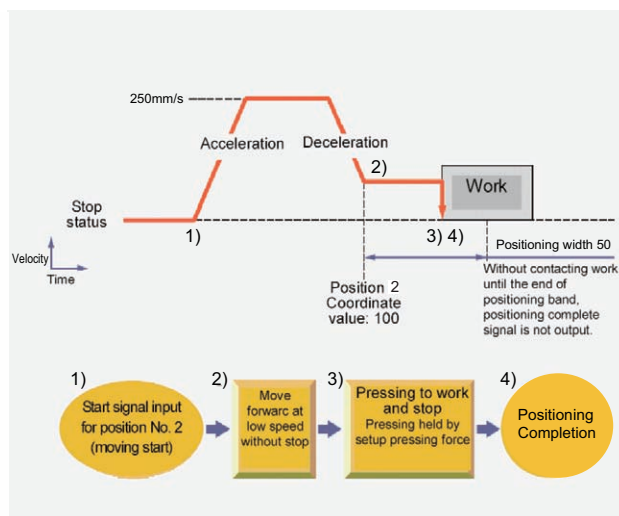

No.	Position [mm]	Velocity [mm/s]	Acceleration [G]	Deceleration [G]	Pressing [%]	Threshold [%]	Positioning width [mm]	Zone+ [mm]	Zone- [mm]	Acceleration/Deceleration mode	Incremental	Transported load	Stop mode
0													
1	0.00	250.00	0.20	0.20	0	0	0.10	0.00	0.00		0	0	0
2	100.00	250.00	0.20	0.20	50	0	50.00	0.00	0.00		0	0	0

(Position No.2 sets pressing operation.)

■ Control method

- 1) The method of controlling the pressing operation is the same as that described in [1] Positioning except the setting of the position table. Any setting of "Pressing" in the position table allows the pressing operation to be done. "Positioning width" is assumed as pressing operation distance.
- 2) The actuator moves at the setting speed and rating torque to the position of the coordinate set in "Position" in the similar way as normal positioning. The operation is executed with the value set in "Positioning Band" for the amount of movement in the pressing operation, and the torque (current limit) set in % in "Pressing" for the pressing operation as the upper limit.
- 3) The control method is the same as that in [1] Positioning. However, the processing of positioning complete signal PEND is different from that in [1] Positioning. PEND is output when the shaft is stopped by pressing (pressing complete). If the work is not subject to pressing (miss-pressing), the actuator moves by the value set in "Positioning width" to stop but PEND is not turned ON. The current position No. PE* is turned ON at the completion of pressing and even in miss-pressing.

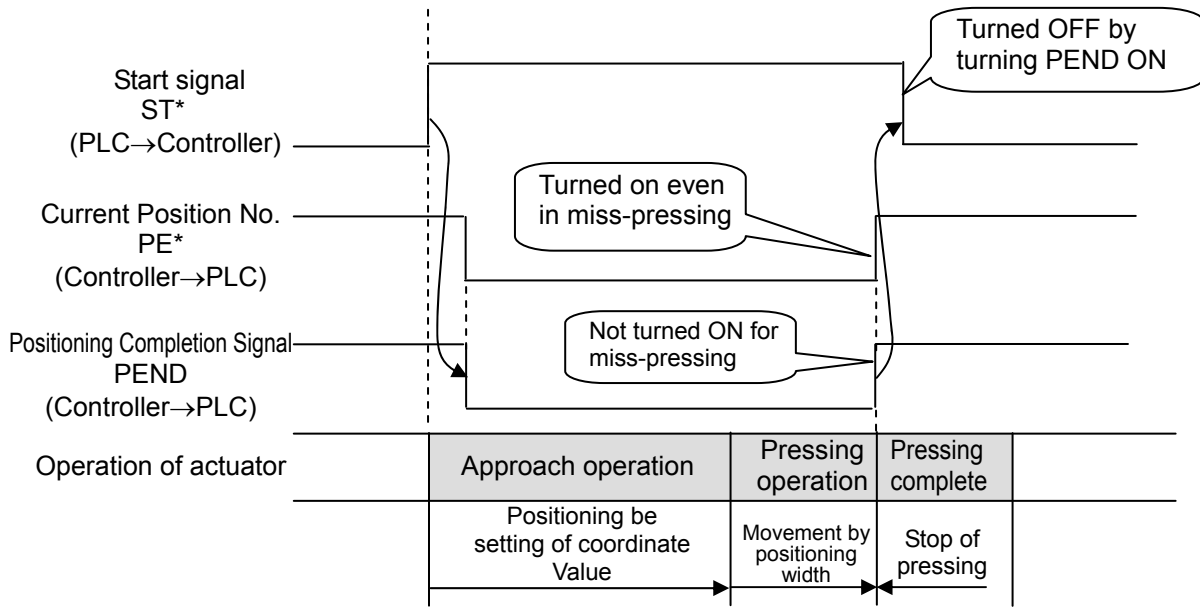

Caution: (1) The speed during pressing operation is set in Parameter No.34. Check the 9.6 List of Specifications of Connectable Actuators for the pressing operation speed. Do not set any value larger than the value in the list. If the speed set in the position table is equal to or less than the pressing speed, the pressing is performed at the setup speed.

(2) The approach start position of pressing should be located at or before the pressing start position (coordinate 100mm or less in the above example) If not, the moving direction varies depending on the start position to be dangerous. For example, pressing at coordinate larger than the pressing end position (larger than 150mm) is performed in the direction from the current position to the pressing end position. It would not proceed to the pressing operation at 150mm point after positioning at 100mm point.

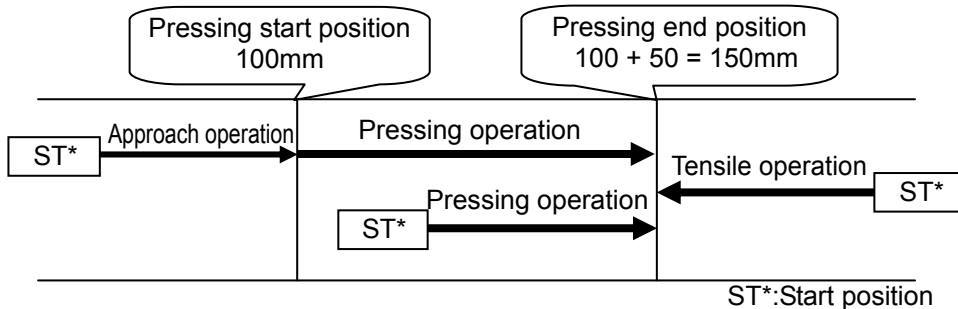

- (3) The work is pressed after the pressing is completed. The work may moves backward or forward. If the actuator is moved backward before the approach position, alarm code 0DC "Pressing motion range over error" occurs to stop the actuator. In movement of the work in the pressing direction, PENDING is turned OFF if the load current becomes lower than the current limit (pressing (%)). Miss-pressing occurs when the actuator moves by the pressing moving distance set in "Positioning width".
- (4) Pressing control cannot be performed with the rotary actuator.
- (5) If the actuator gets pressed to the work during the approach operation, error would be issued.

Judging completion of pressing operation

The operation monitors the torque (current limit value) in percent in "Pressing" of the position table and turns pressing complete signal PEND ON when the load current satisfies the condition shown below during pressing. PEND is turned ON at satisfaction of the condition if the work is not stopped.

(Accumulated time in which current reaches pressing value [%])

– (accumulated time in which current is less than pressing value [%])
 $\geq 255 \text{ ms}$ (Parameter No.6)

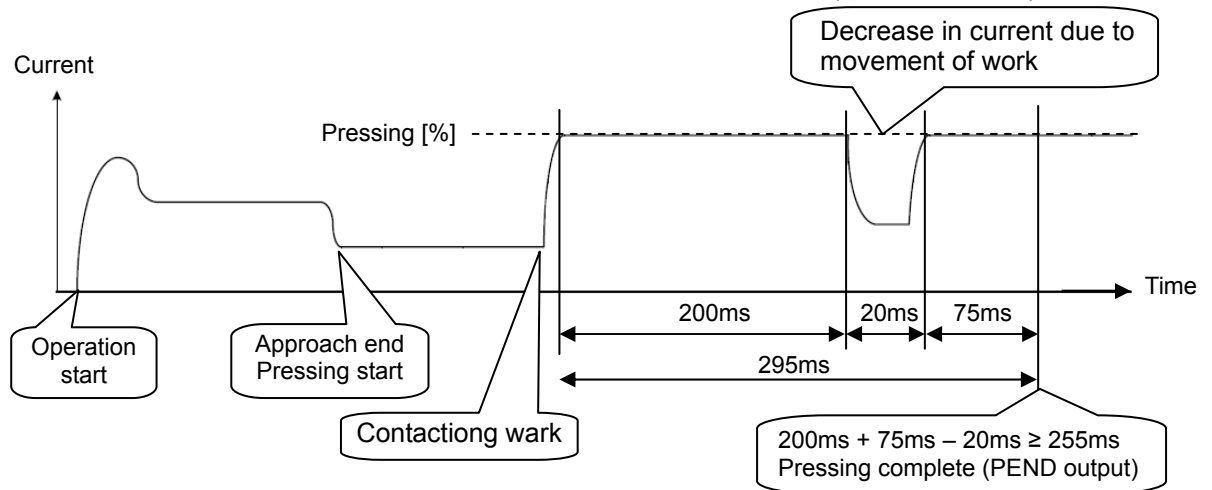

Command Torque Level Detection at Pressing

It is the signal dedicated for High-Thrust Actuator (CFB type). Use this as a reference output for other actuators.

This is a function to detect whether the specified load is applied to the actuator by checking the torque while in press-fitting operation when having a press-fitting process with the pressing operation. If there is no resistance in press-fitting, the specified load would not be applied, thus it is defined as the normal pressing is not conducted and an alarm can be issued from PLC.

Load Output Judgment Status (LOAD) Signal ^(Note 1) turns ON when the pressing current exceeds the value [%] set as the "threshold" of the position data in the pressing operation range (except for approach operation range) and in the range set as the "position zone" in the position data for the duration of judgment time ^(Note 2) or longer. It will not turn OFF even if the load has been removed and the current has dropped. It turns OFF at next movement command or alarm reset.

Torque Level Status (TRQS) Signal ^(Note 1) turns ON when the pressing current exceeds the value [%] set as the "threshold" of the position data in the pressing operation range (except for approach operation range) for the duration of judgment time ^(Note 2) or longer. It turns OFF once it has been confirmed that the load has been removed and the current has dropped.

Note 1 It should be switched to LOAD Signal with "0" set in Parameter No. 51 "Torque inspected range" and TRQS Signal with "1" set in the parameter.

Note 2 Establish the setting in Parameter No.50 "Load Output Judgment Time." (Initial setting: 255ms)

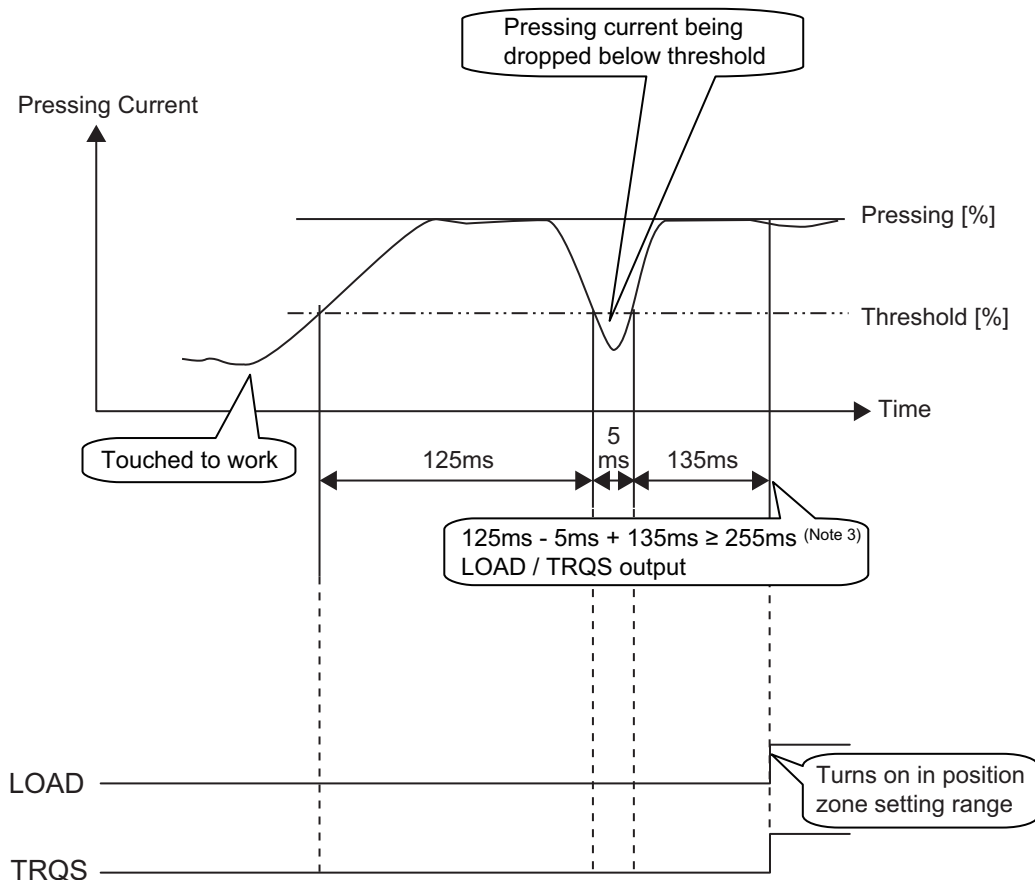

Note 3 (Total time of pressing current to reach above threshold) – (Total time of pressing current to get below threshold) ≥ 255ms (Parameter No. 50)

[4] Tension Operation

■ Image diagram

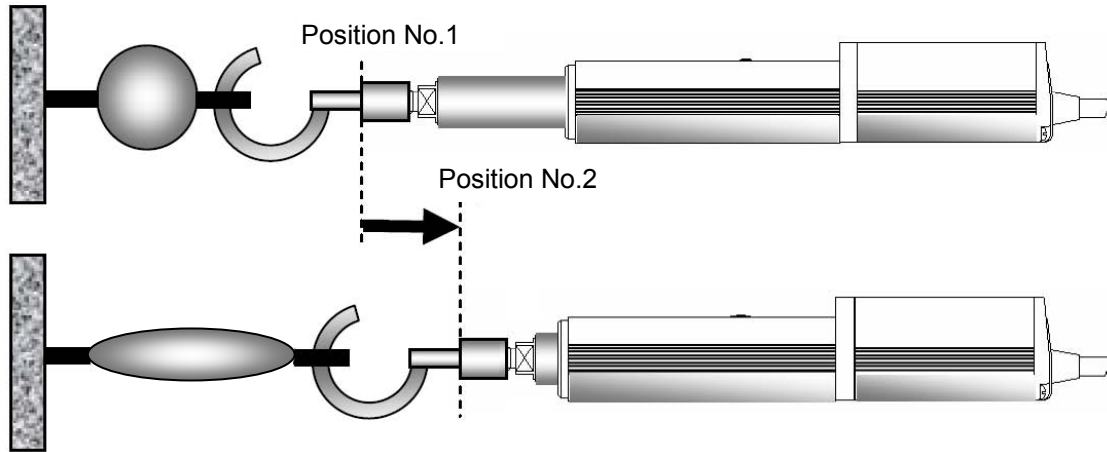

No.	Position [mm]	Velocity [mm/s]	Acceleration [G]	Deceleration [G]	Pressing [%]	Threshold [%]	Positioning width [mm]	Zone+ [mm]	Zone- [mm]	Acceleration/Deceleration mode	Incremental	Transported load	Stop mode
0													
1	100.00	250.00	0.20	0.20	0	0	0.10	0.00	0.00	0	0	0	0
2	80.00	250.00	0.20	0.20	50	0	-50.00	0.00	0.00	0	0	0	0
3													

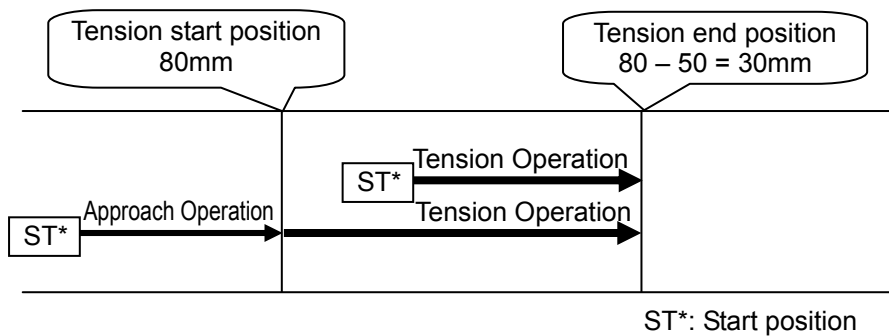

■ Control method

The method of controlling the tension operation is the same as that described in [3] Pressing operation. The control method is explained below by using the sample position table shown above.

- 1) Position No.2 indicates the settings of tension operation. The settings of "Position" and "Positioning width" show the tension start position and the tension quantity, respectively. Attach - (negative sign) to the tension quantity. Specify the upper limit of the torque required for tension in percent (limited current value) in "Pressing". The speed, acceleration, and deceleration are the conditions of positioning to the coordinate value (80mm) set in "Position".
- 2) Position No.1 indicates the tension start preparation position. Specify a value larger than the coordinate value at which the tension provided by position No.2 ends (80 - 50 = 30mm) in "Position".

- 3) First define the positioning in position No.1. Next, the operation in position No.2 moves the actuator to the position of 80mm at the setting speed and rating torque and change to the tension operation. The actuator moves by 50mm in the negative direction in the tension operation. The upper limit of the tensile force is the torque set in percent.
- 4) In the similar way as pressing, the positioning complete signal is output when the shaft is stopped by tension (pressing complete). If the actuator cannot be stopped during movement within the setting positioning width (miss-pressing), it moves by the setting distance to stop but PEND is not turned ON. The current position No. PE* is turned on at the completion of pressing and even in miss-pressing.

Caution: (1) The speed during tension operation is set in Parameter No.34. [Refer to 9.6 List of Specifications of Connectable Actuators for the pressing speed.] Do not set any value larger than the value in the list. If the speed set in the position table is equal to or less than the tension speed, the tension operation is performed at the setup speed.

(2) The tension ready position should be the tension start position or forward. If not, the moving direction varies depending on the start position to be dangerous.
The tension operation from a coordinate (less than 30mm = 80 – 50) located before the end position (30mm) changes to the pressing operation from the current position to the tension end position. Note that the tension operation after positioning to the position of 80mm does not take place.

ST*: Start position

(3) The work is pulled also after completion of the tension. The work is drawn back or pulled further if the work is moved. When the work is drawn back before the approach position, alarm code 0DC “pressing operation range error” occurs to stop the work. When the work is moved in the tension direction and the load current becomes less than the current limit value (pressing in percent), PEND is turned OFF. Naturally, the work reaches the tension moving distance set in “Positioning width” to cause miss-pressing.

(4) Pulling operation cannot be performed with the rotary actuator.

Command Torque Level Detection at Pulling

It is available to use in the same manner as for pressing. [Refer to Pressing Operation in 3.2.5 [3] Position Number Input Operation = PIO Pattern 4.]

[5] Multi-step Pressing
 ■ Image diagram

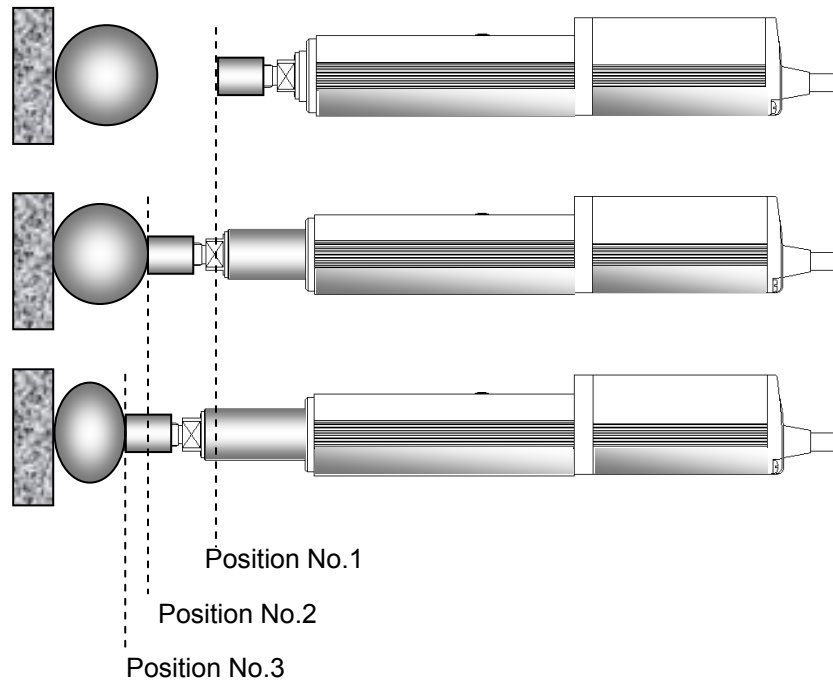

No.	Position [mm]	Velocity [mm/s]	Acceleration [G]	Deceleration [G]	Pressing [%]	Threshold [%]	Positioning width [mm]	Zone+ [mm]	Zone- [mm]	Acceleration/Deceleration mode	Incremental	Transported load	Stop mode
0													
1	0.00	250.00	0.20	0.20	0	0	0.10	0.00	0.00	0	0	0	0
2	50.00	250.00	0.20	0.20	30	0	20.00	0.00	0.00	0	0	0	0
3	50.00	250.00	0.20	0.20	50	0	20.00	0.00	0.00	0	0	0	0
4													

■ Control method

After pressing, the pressing pressure can only be changed in the pressing state. The method of controlling multi-step pressing is the same as that described in [3] Pressing operation.

- 1) Set the weak pressing (30%) in position No.2 and perform the pressing operation.
- 2) If pressing complete signal PEND is turned ON, start the pressing operation with pressing pressure (50%) greater than the first pressure set in position No.3.
 In this particular operation, turn ON ST3 after completion of ST2, and turn OFF ST2 when PEND is turned OFF. In usual case, do not turn ON two or more ST* signals simultaneously. The position data in position No.3 should be the same as that in position No.2 except the setting in "Pressing".
- 3) To add a pressing step with another pressing pressure, add a sequence consisting of a position number and a pressing operation.

[6] Pause and Operation Interruption (ST*, *STP, RES, PE*, PEND)

Pause is possible during movement. In this mode, the following two methods are possible for pause.

- 1) Use of pause signal *STP
Turning reset signal RES ON during the pause allows the remaining moving distance to be cancelled to interrupt the operation.
- 2) Use of start signal ST*
This method is valid when Parameter No.27 "Move command type" is set to "0" (factory setting). The actuator can only be moved while the ST* signal is set to ON and stopped if ST* is turned OFF. Since setting the ST* signal to OFF is assumed as interrupt of operation, the remaining moving distance may not be cancelled.

(1) Use of pause signal *STP

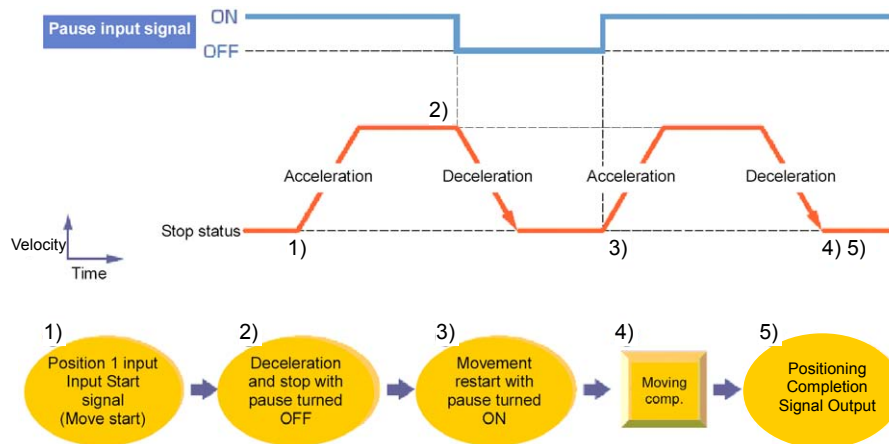

■ Control method

The pause signal is an input signal always set to ON. So, it is normally used to remain ON. Use this function for interlock in case where an object is invaded into the moving direction of the actuator being moved.

- 1) If pause signal *STP is turned off during operation of the actuator, the actuator is decelerated to a stop. The deceleration is defined by the value set in the position table.
- 2) During pause, current position No. PE* and positioning complete signal PEND are not turned ON.
- 3) If pause signal *STP is returned to ON, the actuator continues the remaining movement. The acceleration is the value set in the position table.
- 4) Turning reset signal RES ON during pause (*STP during OFF) allows the remaining movement to be cancelled to interrupt the operation.

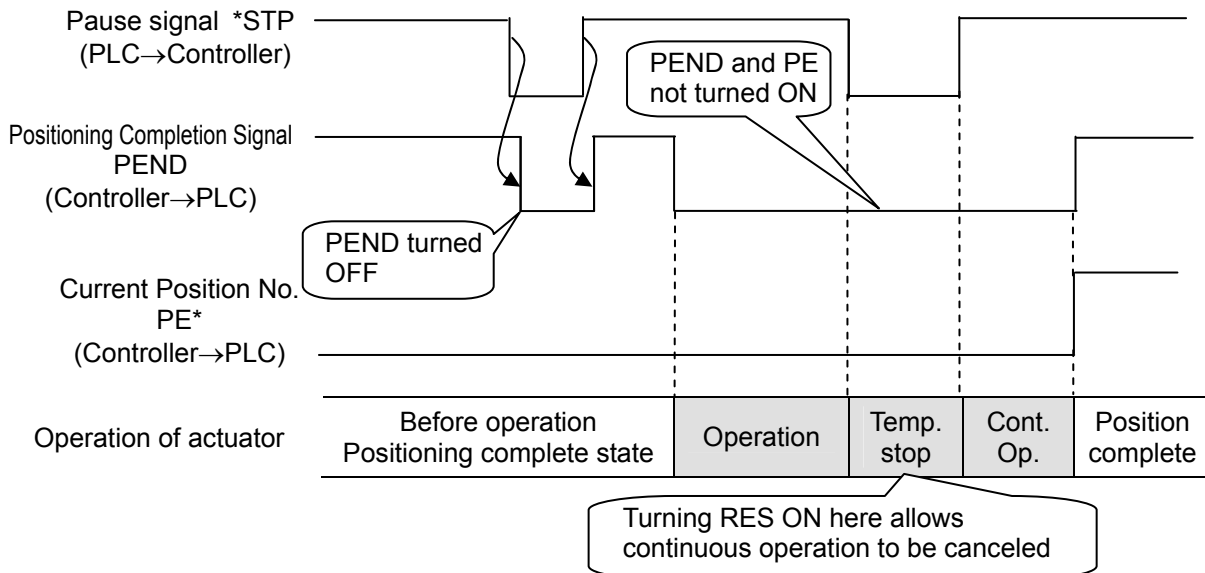

⚠ Caution: (1) At occurrence of an alarm in the release level^{Note 1}, RES can reset the alarm. Cancel the remaining moving distance after confirmation that alarm signal *ALM (being ON in normal state and OFF at occurrence of an alarm) is set to ON.
 Note 1: [Refer to 8.4 Alarm List for details of alarms.]
 (2) Turning *STP OFF with the actuator being in the positioning complete state causes PEND to be turned OFF. Note that this situation may not occur when a sequence program is created.

(2) Use of start signal ST*

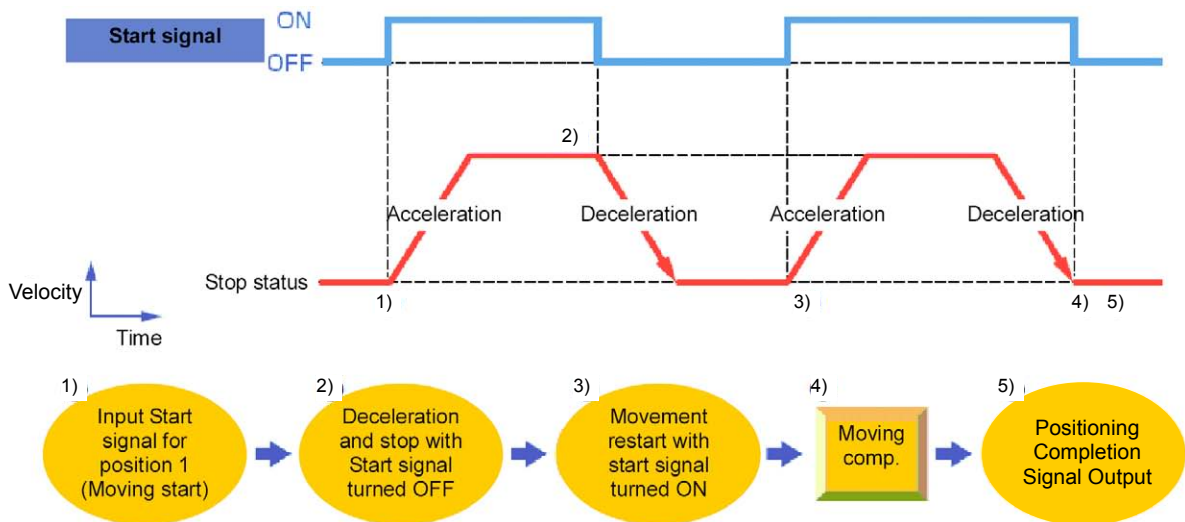

■ Control method

If start signal ST* is turned OFF during movement, the actuator can be paused. Use the control method for interlock in case where an object is invaded into the moving direction of the actuator being moved.

- 1) If the ST* signal is turned OFF during movement, the actuator is paused. The deceleration is the value set in the position table.
- 2) Turning the ST* signal OFF causes the positioning to be interrupted and deemed complete signal PEND to be turned ON.
- 3) If the ST* signal is turned ON again, the remaining movement is continued. The acceleration is the value set in the position table.

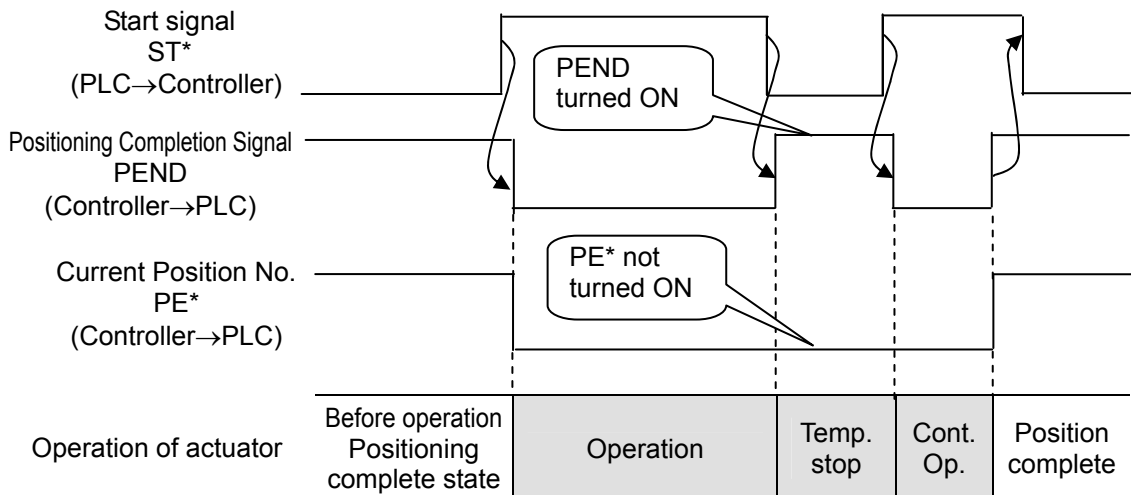

3.2.6 Direct Position Specification (Solenoid Valve Mode 2) = Operation of PIO Pattern 5

The start signal is provided for every position number. Only turning ON the relevant input signal according to the table shown below allows the operation based on the data in the target position number to be performed. The operation mode is called the solenoid valve mode because solenoid valves can directly drive air cylinders.

Also, in the positioning width set in each position, LS* Signal should turn ON once the actuator gets in the range of the setting values just like it does in detection with a sensor in operation to any position number or even when the servo gets turned off and the actuator is moved manually by hand.

Positioning and speed change during operation are possible. Their control methods are the same as those of other patterns.

⚠ Caution: This pattern does not allow pressing and pitch feed.

[1] Home Return (ST0, HEND)

The I/O of PIO varies as shown in the table below depending on the position number before home return.

Position No.	Input	Output
0	ST0 ^(Note 1)	LS0
1	ST1 ⇒ JOG+	LS1 ⇒ TRQS
2	ST2 ⇒ Invalid	LS2 ⇒ Invalid

For incremental type and for absolute type with the home-return operation incomplete, the actuator should conduct the home-return operation when ST0 gets turned ON while the home-return operation is incomplete (HEND = OFF). Once the home-return operation completes, the home-return complete signal HEND should turn ON. Turn OFF ST0 Signal once HEND Signal turns ON. The home-return complete signal HEND is kept ON once it turns ON even if the actuator gets off the home position unless the home position is lost. ^(Note 2)

Before home return, start signal ST1 works as JOG+. By using this function, move the actuator to a position at which home return can be done safely. The speed of JOG+ is the home return speed. (TRQS should be output when the actuator hits an obstacle or the stroke end and become unable to move and the current of the motor exceeds the home-return current limit value.)

For incremental type, after the home-return operation is complete, the actuator conducts positioning to Position No. 0 when ST0 = ON. [Refer to 3.2.6 [3] Positioning.]

If a certain home positioning is required, Set "Position" of position No.0 to 0 mm and the ST0 signal is not changed by the HEND signal to remain ON.

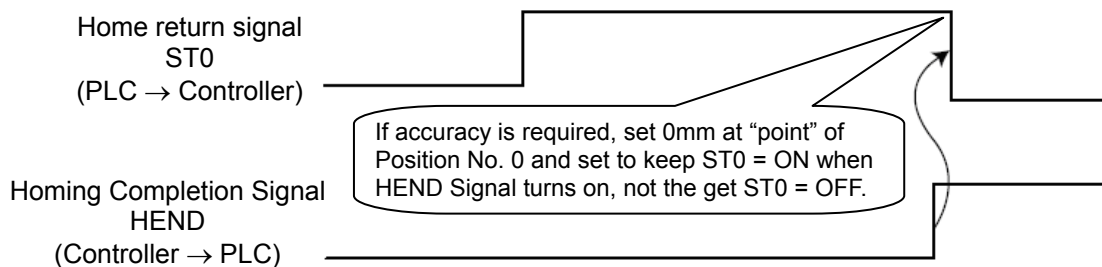

Note 1 Regarding Start Signal ST0 before Home-Return Operation

- When Parameter No. 27 "Move command type" Set to "0 (factory setting)"
The actuator moves to the home direction while ST0 Signal is ON and stops when ST0 Signal turns OFF. Once it reaches the mechanical end with ST0 Signal ON, the home-return operation will be performed.
- When Parameter No. 27 "Move command type" Set to "1"
The home-return operation starts at the same time as ST0 Signal turns ON. Operation will not stop even if ST0 Signal turns OFF.

Note 2 For RCP5 absolute setting, HEND = OFF should be kept till servo gets on after the power is turned ON.

⚠ Caution: Note that the actuator may go for positioning without stopping after home-return complete in some settings.

[Home Return Operation of Slider Type/Rod Type Actuator]

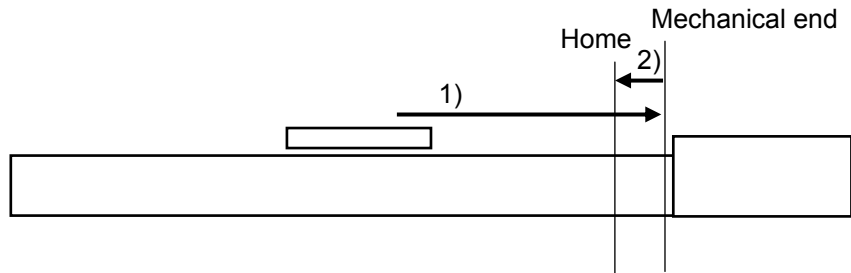

- 1) With the ST0 signal being ON, the actuator moves toward the mechanical end at the home return speed. The moving speed is 20mm/s for most actuators but less than 20mm/s for some actuators.
- 2) The actuator is turned at the mechanical end and stopped at the home position. The moving distance is the value set by Parameter No.22 "Home return offset level".

 Caution: In the home reverse specification, the actuator moves in the reverse direction. Make sure to refer to Section 7.2 [16] when a change to Parameter No.22 "Home return offset level" is required.

[Home Return Operation of Rotary Actuator]

(1) 330° Rotation Specification

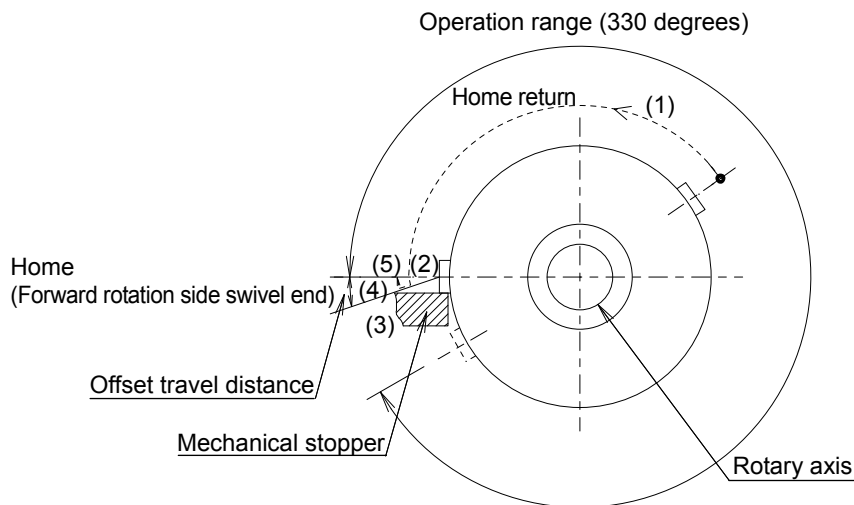

- 1) When home return is commanded, the rotary part rotates in the CCW (counterclockwise) direction as seen from the load side. The speed is 20 deg/s.
- 2) Detects mechanical stopper.
- 3) It travels in reverse.
- 4) Moves from the position of (3) for the amount set in Parameter No. 22 "Homing Offset" and stops.
- 5) The position stopped in (4) should be the home position.

 Caution: Make sure to refer to Section 7.2 [16] when a change to Parameter No.22 "Home return offset level" is required.

(2) Multi-Rotation Specification

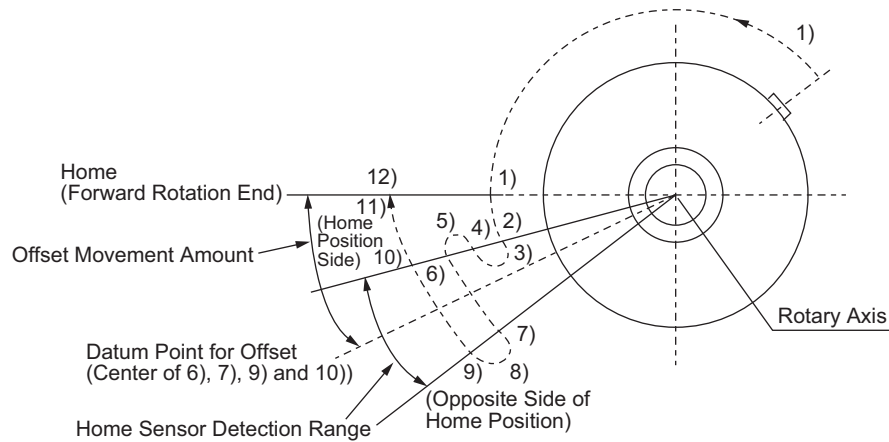

- 1) Once the home-return command is issued by turning ST0 Signal ON, the actuator rotates in CCW (counterclockwise) direction from the view point of the load side. The velocity is 20deg/s.
- 2) Home sensor turns ON.
- 3) Starts reversed rotation.
- 4) Goes back to a point exceeded the home sensor detection range, and confirms the home sensor is turned OFF.
- 5) Starts reversed rotation.
- 6) Confirms the home sensor gets turned ON again.
- 7) Goes to a point exceeded the home sensor detection range on the opposite side of the home position, and confirms the home sensor is turned OFF.
- 8) Starts reversed rotation.
- 9) Confirms the home sensor turns ON.
- 10) Goes to a point exceeded the home sensor detection range on the home position side, and confirms the home sensor is turned OFF.
- 11) Based on the result gained from 6), 7), 9) and 10), the center of the home sensor detection range is calculated.
- 12) Moves for the amount set in Parameter No.22 "Home return offset level" from the position of 11), and stops at the home position.

⚠ Caution: The operation of the reversed rotation type should be in the reversed way. Make sure to refer to Section 7.2 [16] when a change to Parameter No.22 "Home return offset level" is required.

[Home Return Operation of Actuator of Gripper Type]

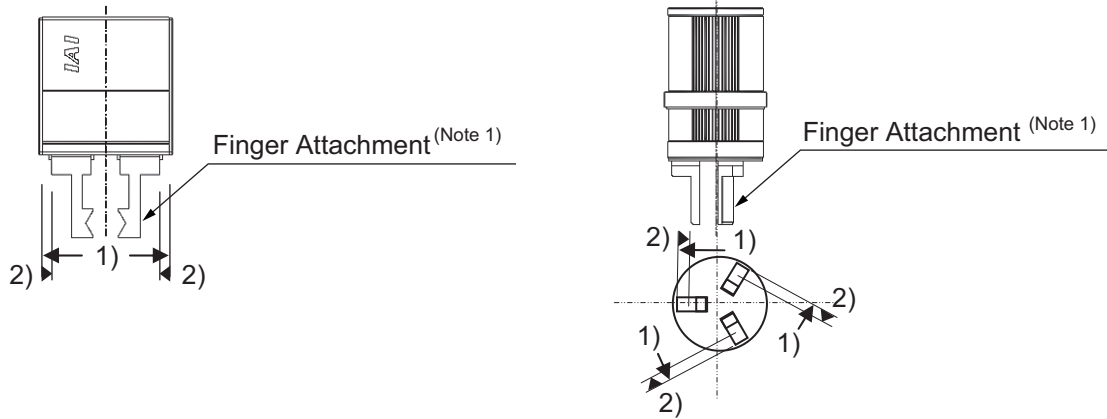

- 1) If the ST0 signal is turned ON, the actuator moves toward the mechanical end (to end side) at the home return speed (20mm/s).
- 2) The actuator is turned at the mechanical end and stopped at the home position. The moving distance is the value set by Parameter No.22 "Home return offset level".

 Caution: Make sure to refer to Section 7.2 [16] when a change to Parameter No.22 "Home return offset level" is required.

Note 1 Finger attachment is not included in the actuator package. Please prepare separately.

[2] Features of LS Signals (LS0 to 2)

The LS* signals are not complete signals for positioning commands such as those for other PIO patterns. Just as it does in detection with a sensor, the applicable LS* Signal should turn ON once the actuator gets in the range of the setting values regardless of the indicated position number.

(Example) The figure below shows the position table and the position at which each of the LS signals is turned ON. It turns ON if the actuator is in the set range even when in operation to another position number or with the actuator in a manual operation by hand while the servo is OFF.

No.	Position [mm]	Velocity [mm/s]	Acceleration [G]	Deceleration [G]	Pressing [%]	Threshold [%]	Positioning width [mm]	Zone+ [mm]	Zone- [mm]	Acceleration/Deceleration mode	Incremental	Transported load	Stop mode
0	0.00	250.00	0.20	0.20	0	0	5.00	0.00	0.00	0	0	0	0
1	70.00	250.00	0.20	0.20	0	0	10.00	0.00	0.00	0	0	0	0
2	150.00	250.00	0.20	0.20	0	0	5.00	0.00	0.00	0	0	0	0

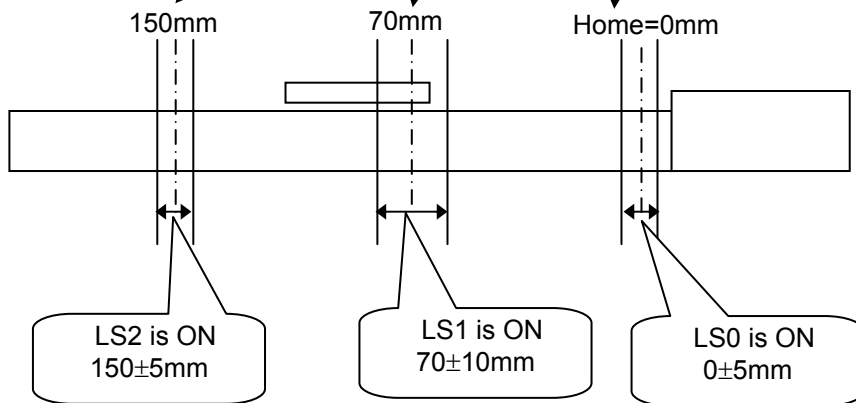

Caution: LS* signal would not be output if the positioning width is set less than the minimum resolution.

[3] Positioning [Basic] (ST0 to ST2, LS0 to LS2)

Position No.	Input	Output
0	ST0	LS0
1	ST1	LS1
2	ST2	LS2

(Note) Pressing and pitch feed are unavailable.

■ Sample use

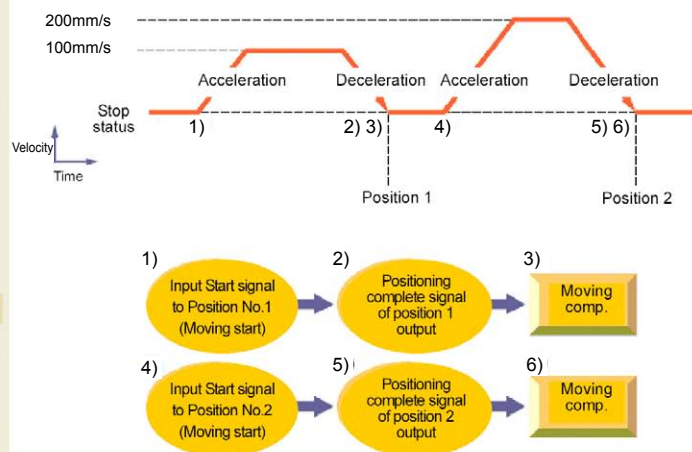
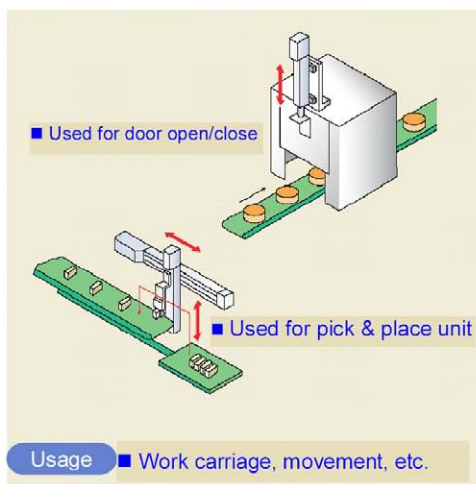

No.	Position [mm]	Velocity [mm/s]	Acceleration [G]	Deceleration [G]	Pressing [%]	Threshold [%]	Positioning width [mm]	Zone+ [mm]	Zone- [mm]	Acceleration/Deceleration mode	Incremental	Transported load	Stop mode
0	0.00	100.00	0.20	0.20	0	0	0.10	0.00	0.00	0	0	0	0
1	70.00	100.00	0.20	0.20	0	0	0.10	0.00	0.00	0	0	0	0
2	150.00	200.00	0.20	0.20	0	0	0.10	0.00	0.00	0	0	0	0

■ Control method

- 1) When start signal ST* is turned ON, the actuator starts acceleration based on the data in the specified position table for positioning to the target position. Turning the ST* signal OFF on the way causes the actuator to be decelerated and stopped. So, make the ST* signal remain ON until the actuator reaches the target position.
- 2) At the completion of positioning, position detection output LS* of the specified position is turned ON.
- 3) Position detection output LS* is turned ON if the remaining moving distance enters into the positioning width. LS* is set to ON if the current position is located within the positioning width zone or OFF if the current position is located out of the positioning width zone (the same situation occurs in the servo OFF status).
- 4) Leave the ST* signal to be ON until the actuator is moved to another position and turn off it at the next ST* signal. If the ST* signal is turned OFF at the LS* signal, the actuator is decelerated to a stop in the positioning width and thus the actuator may not reach the target position. In continuous operation, turn on the next ST* signal by setting the positioning width within the required precision range or setting the period taken from detection of the LS* signal to reaching the target position.

(Example) Repetition of ST1 → ST2 → ST1 → ...
 Insert timer Δt if necessary.

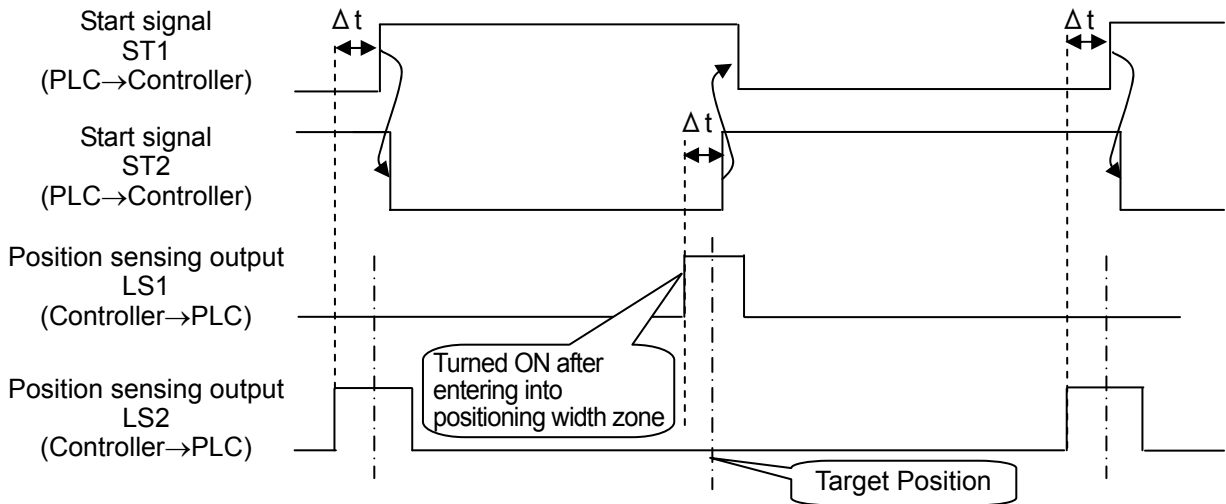

Δt : Time required to certainly reach the target position after the position sensing output LS1 or 2 is turned on.

[Example of stop position when the ST* signal is turned OFF by the LS* signal]

If the positioning width is set at a position before the original deceleration start position, the actuator cannot reach the target position.

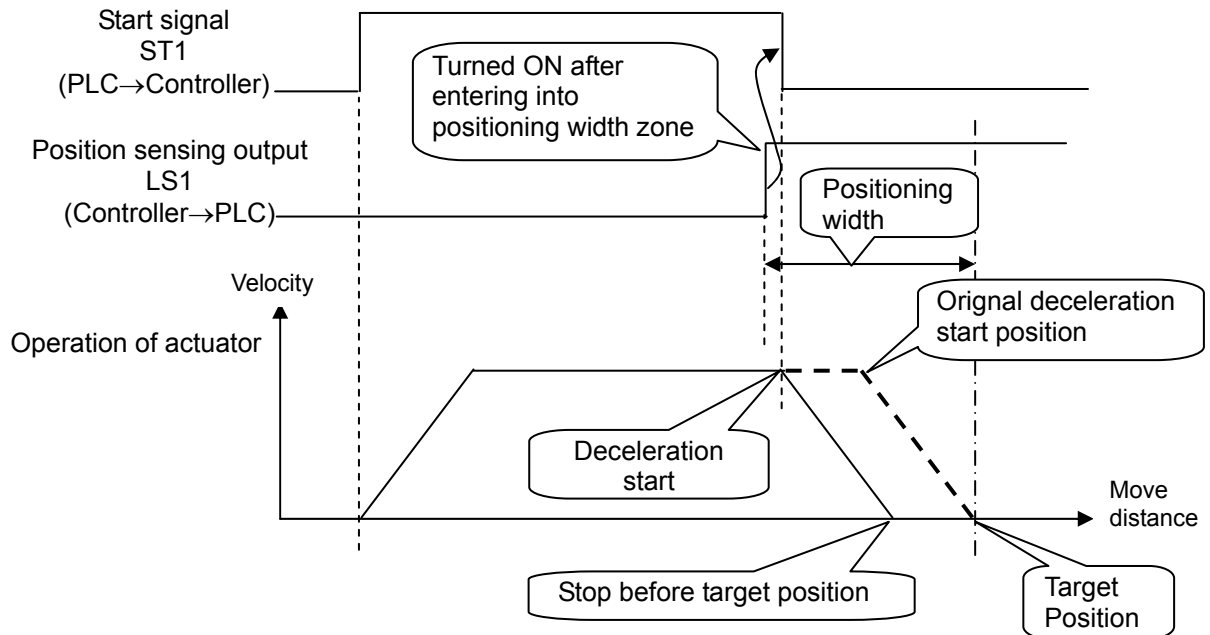

⚠ Caution:

- (1) If the ST* signal for the position is turned ON after the completion of positioning, the LS* signal remains ON.
- (2) Both the LS* and PEND signals are set to ON in the positioning width zone. Accordingly, they may be turned ON under operation of the actuator if a large positioning width is set.
- (3) Interlock should be taken so that two or more ST* signals are set to ON simultaneously. If two or more ST* signals are input simultaneously, they will be executed according to the following priorities: ST0→ST1→ST2
- (4) LS* signal would not be output if the positioning width is set less than the minimum resolution.

[4] Speed Change During the Movement

■ Sample use

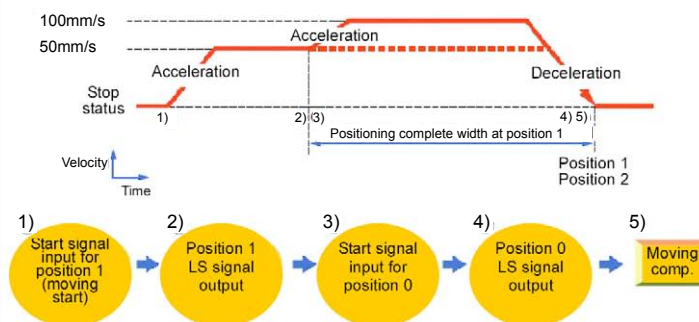
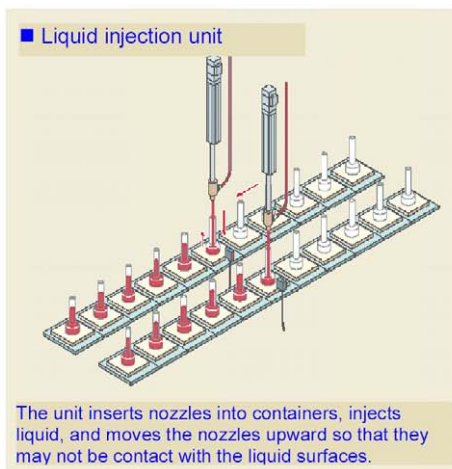

No.	Position [mm]	Velocity [mm/s]	Acceleration [G]	Deceleration [G]	Pressing [%]	Threshold [%]	Positioning width [mm]	Zone+ [mm]	Zone- [mm]	Acceleration/Deceleration mode	Incremental	Transported load	Stop mode
0	0.00	100.00	0.20	0.20	0	0	0.10	0.00	0.00	0	0	0	0
1	0.00	50.00	0.20	0.20	0	0	100.00	0.00	0.00	0	0	0	0
2	150.00	200.00	0.20	0.20	0	0	0.10	0.00	0.00	0	0	0	0

■ Control method

The speed of the actuator can be changed while it moves. The operation control method is the same as that in [3] Positioning. This pattern prioritizes the startup signal commanded first. Therefore, when another position number is started during an operation and the first startup signal is turned OFF, and then the new position number condition starts to operation at this moment (velocity change).

- 1) In this example, the speed is changed while the actuator moves from the position of 150mm to the position of 0mm. At first, set the positioning to the target position at the first speed in position No.1. In the positioning width, set the distance from the speed change position to the target position. The value is set to 100mm in the example. Thus, for position No.1, position sensing signal LS1 is turned ON at the position before the target position by 100mm.
- 2) Set the positioning to the target position at the second speed in position No.0.
- 3) And then, after starting up Position No. 0 (ST0 Signal) with the position detection output signal LS1 in Position No. 1 by starting up Position No. 1 (ST1 Signal), turn OFF ST1 Signal. The operation switches over to Position No. 0 as soon as ST1 Signal is turned OFF.

In this example, the target positions No.0 and 1 are equal with each other. They may not be the same. However, setting the target positions to be equal with each other allows the distance from the speed change position to the target position to be known easily. Depending on the timing when the actuator accepts the input signal, the speed change may be delayed a little. Changing the positioning width can adjust the timing.

The timing chart shown below indicates that the actuator changes its speed while it moves to position No.1 after the completion of positioning at position No.2 and moves to position No.0.

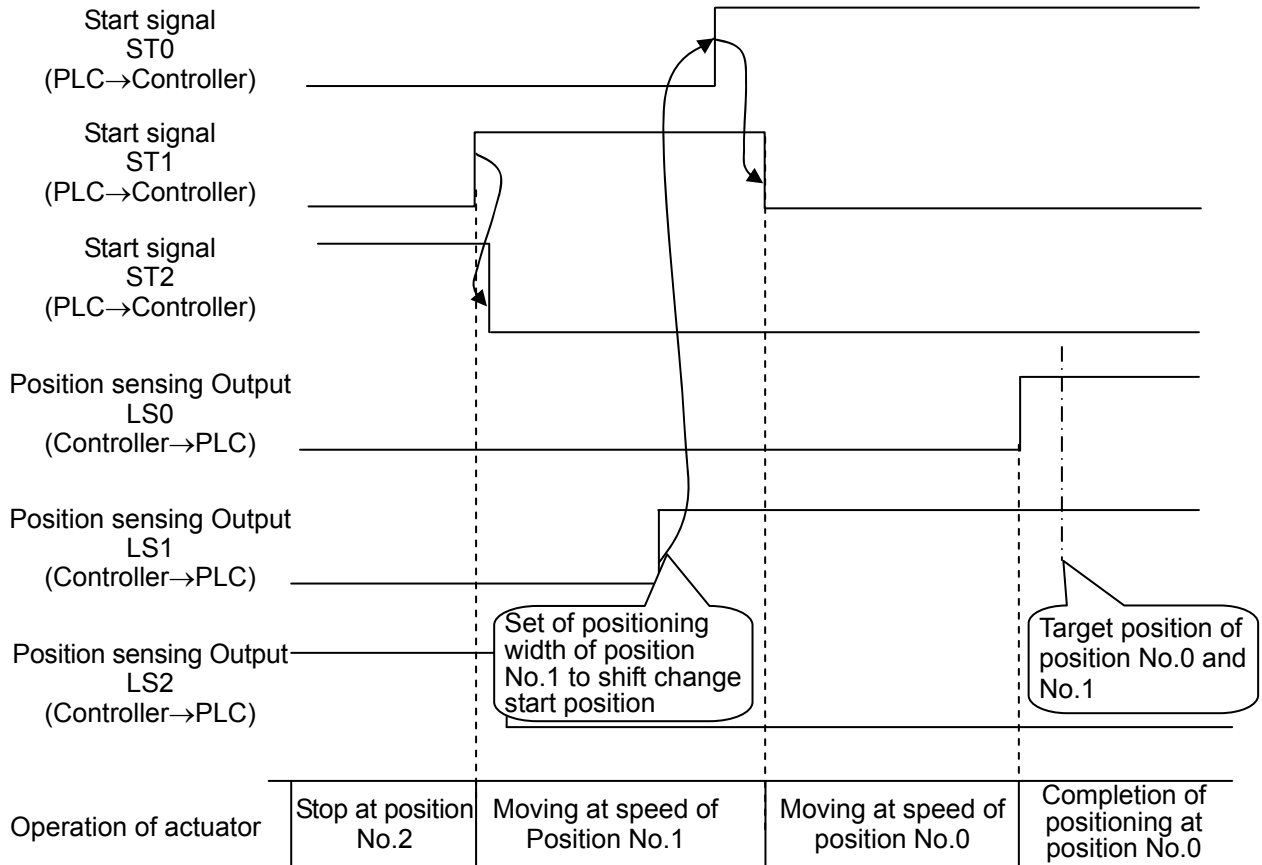

[5] Pause and Operation Interruption (ST*, *STP, RES, LS*, PEND)

Turning start signal ST* OFF allows the actuator to be paused while it is moved. To restart it, turn the same ST* signal ON.

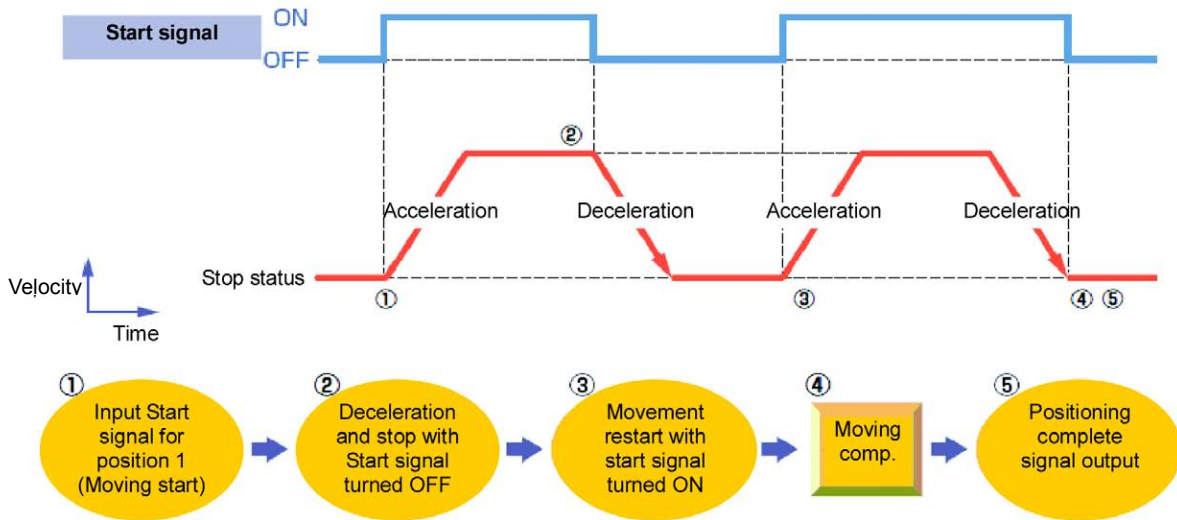

■ Control method

If start signal ST* is turned OFF during movement, the actuator can be paused.

Use the control method for interlock in case where an object is invaded into the moving direction of the actuator being moved.

- 1) If the ST* signal is turned OFF during movement, the actuator is decelerated to a stop. The deceleration is the value set in the position table.
- 2) If the ST* signal is turned ON again, the remaining movement is continued. The acceleration is the value set in the position table.

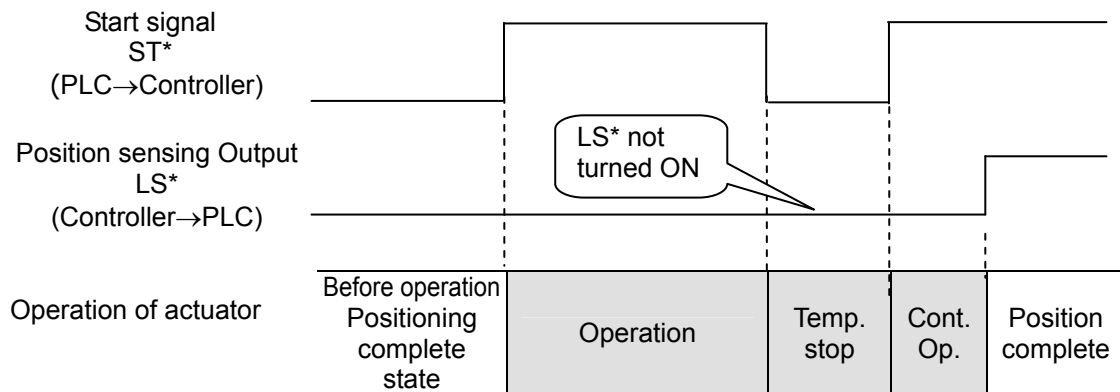

3.3 Pulse Train Control Mode (for Pulse Train Type)

This controller can switch over the mode between positioner mode and pulse train control mode with the parameters. In Pulse Train Mode, there are 2 types, incremental type for actuator (PIO Pattern 6) and (Battery-less) absolute type for actuator (PIO Pattern 7), the actuator can be operated by the pulse train output of the host controller (PLC) positioning control function. This operation mode is not to be changed after the system is complete to be established or during an operation.

⚠ Caution: • In Pulse Train Control Mode, the operation is performed corresponding to the input pulse.

Input Pulse Value	⇒ Moving distance
Input pulse frequency	⇒ Velocity
Change in Input Pulse Frequency	⇒ Velocity change and acceleration/deceleration

Do not use the actuator above the specifications for the commands of the movement amount, acceleration and deceleration from the host controller (PLC). Doing so may cause an abnormal noise or malfunction.

The pressing operation velocity should be set to the rated pressing velocity described in “9.6 List of Specifications of Connectable Actuators” when it is to conduct the pressing operation. Pressing with velocity not at the rated pressing velocity could end up with pressing force different from that shown in “Push Force / Gripping Force and Current Limit Value” in Appendix in Chapter 9. Also, operation in velocity higher than the rated pressing velocity could cause an error or malfunction.

■ Main Functions

	Function Name	Name
1	Dedicated home return signal	When this function (signal) is used, home return can be performed without using a complex sequence or an external sensor, etc.
2	Brake control function	Since the controller controls the brake, there is no need to program a separate sequence. The electromagnetic brake power is supplied to the controller from a power supply different from the main power. Accordingly, the electromagnetic brake can be released freely after the main power has been cut off.
3	Torque limiting function	The torque can be limited (a desired limit can be set by a parameter) using an external signal. When the torque reaches the specified level, a signal will be output. This function (signal) permits pressing and press fitting operations.
4	Position-command primary filter function	Soft start and stop can be achieved even when the actuator is operated in the command-pulse input mode where acceleration and deceleration are not considered.
5	Resistration of datum position PIO Pattern 7 : Dedicated for absolute type	Operation is available with the datum position set up at any position in the movable range of the actuator.

3.3.1 I/O Signal Controls

The input signals of this controller incorporate an input time constant to prevent malfunction due to chattering, noise, etc. Make sure to input the signals continuously for 6ms or more.
 (Note) Command pulse train inputs (PP, /PP, NP, /NP) do not have input time constants. Also, it is necessary to input 16ms or more for CSTP Signal.

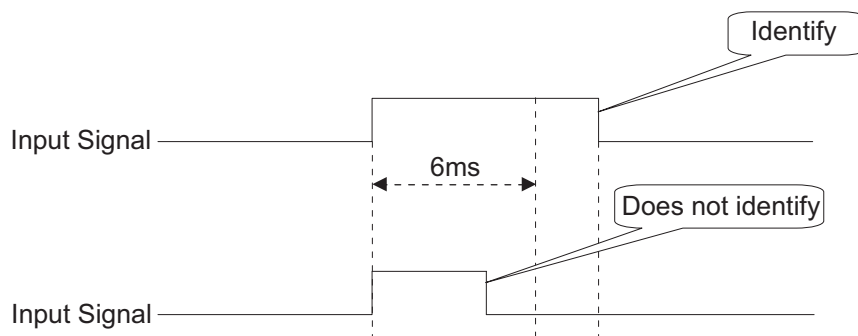

⚠ Caution: To use I/O signals, be sure to tilt the operation mode setting switch on the front panel of the controller to the "AUTO" position.

3.3.2 Operation Ready and Auxiliary Signals

[1] System Ready (PWR)

PIO signal	Output
	PWR

The signal is turned ON if the controller can be controlled after main power-on. It is turned ON once the initialization terminates normally after main power-on and PCON can be controlled regardless of alarm and servo status. Even in the alarm condition, when the PCON can control the system, it is turned "ON".

[2] Emergency Stop Status (*EMGS)

PIO signal	Output
	*EMGS

- 1) The emergency stop status EMGS is turned ON when in normal condition and turned OFF when EMG terminal on "2.1.3 [1] Power Supply Connector" is 0V (emergency stop condition or disconnected).
- 2) It turns back ON once the emergency stop condition is released and EMG terminal goes up to 24V DC. Have an appropriate safety treatment such as interlock with this signal for the host controller (PLC, etc.).

⚠ Caution: It is not an emergency stop output due to an alarm generation of the controller.

[3] Operation Mode (RMOD, RMDS)

PIO signal	Input	Output
	RMOD	RMDS

Two operation modes are provided so that the operation by PIO signals does not overlap with the operation by a teaching tool such as PC software through SIO communication. The mode change is done by the operation mode setting switch on the front panel of the controller.

- AUTO Operation by PIO signals is valid.
- MANU Operation through SIO communication is valid.

However, the controller is subject to link connection ^(Note 1) to connect with a teaching tool such as PC software by using a SIO converter, the controller may be far apart from the teaching tool. In such a case, the controller can be entered into the MANU mode by setting PIO signal RMOD to ON.

Because the RMDS signal is set to ON with the MANU mode selected by using the signal, make the operation sequence interlocked.

The table below lists the switches on the front panel, the modes selected by the RMOD signal and the corresponding output states of the RMDS signal.

Note 1 For the details of the link connection, refer to “9.1 Way to Set Multiple Controllers with 1 Teaching Tool”.

○: Selected or set to ON ×: Unselected or set to OFF

Condition		Status							
Teaching tool such as PC software	PIO Operation Invalid ^(Note 2)	○	○	○	○	×	×	×	×
	PIO Operation Allowed ^(Note 2)	×	×	×	×	○	○	○	○
Switches on front panel	AUTO	○	○	×	×	○	○	×	×
	MANU	×	×	○	○	×	×	○	○
PIO Input	RMOD	×	○	×	○	×	○	×	○
PIO Output	RMDS	×	○	○	○	×	○	○	○
PIO valid: ◎, PIO invalid: ●		◎	◎	●	●	●	◎	◎	◎

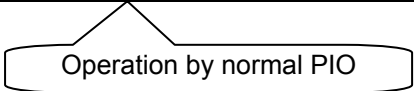

Note 2 “PIO valid” or “PIO invalid” is the function to select a restriction while the teaching tool such as PC software is connected.

⚠ Caution: (1) Note that selecting “PIO start enable” by using the teaching tool such as PC software makes all PIO signals valid to enable operation however the states of the switches and RMOD signal input may be. In this status, the actuator may be started depending on the signals from PLC.

(2) If the teaching tool such as PC software is disconnected from the controller, “PIO start enable” or “PIO start disable” holds the state selected before. After teaching operation or debugging is terminated, select “PIO start enable” and disconnect the teaching tool such as PC software from the controller.

[4] Compulsory Stop (CSTP)

PIO signal	Input
	CSTP

This signal is used to forcibly stop the actuator.

Input the CSTP signal continuously for 16ms or longer. Once the CSTP signal is received, the actuator decelerates and stops with the maximum torque, and then turns the servo OFF. At this time, the deviation counter is cleared.

[5] Servo ON (SON, SV)

PIO signal	Input	Output
	SON	SV

- 1) Servo ON signal SON is the input signal making the servo motor of the actuator operable.
- 2) If the servo-on is performed to enable operation, the SV output signal is turned ON. Concurrently positioning completion signal INP is turned ON.
- 3) With the power being supplied, then controller cannot be operated while the SV signal remains OFF. If the SON signal is turned OFF under operation of the actuator, the actuator is decelerated and stopped with the maximum torque. After the stop, the servo OFF occurs to enter the motor into the free running state. The brake (option) is of release-in-excitation type. Therefore, making the excitation on will release the brake while making it off will lock the brake.

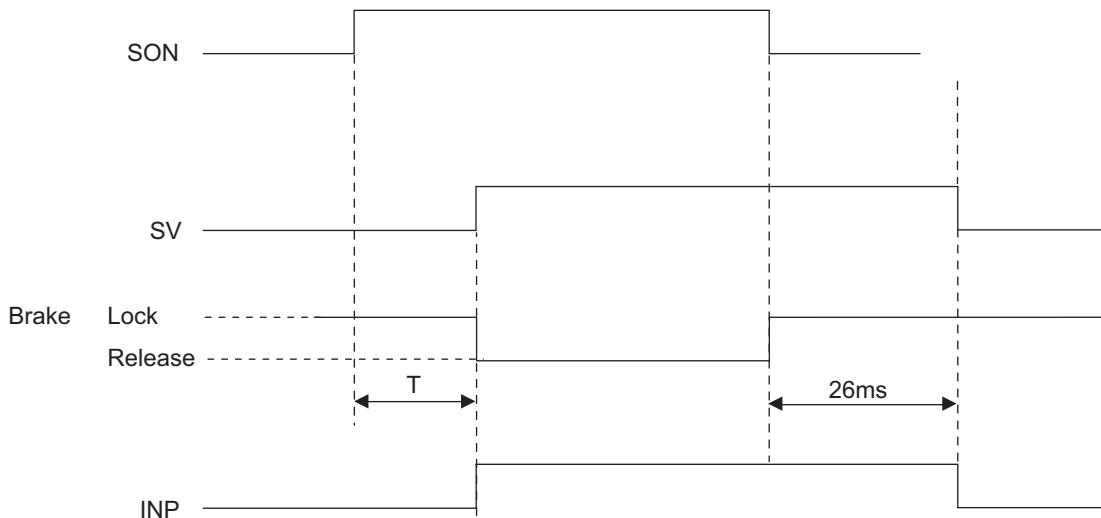

$$T \text{ (before detecting excitation)}^{(Note 1)} = \text{SON signal identification (6ms)} + \text{Excitation detection time (T1 + T2) } \times \text{Number of retry (10 times Max.)} + \text{Servo ON delay time (T3)}$$

$$T \text{ (after detecting excitation)}^{(Note 1)} = \text{SON signal identification (6ms)} + \text{Servo ON delay time (T3)}$$

- T1 : Parameter No.30 It differs depending on the setting of excitation detection type.
 Set Value = 0 → 160ms
 Set Value = 1, 2 → 220ms
- T2 : Parameter No.29 Setting of excitation phase signal detection time
 It is set to 10ms in the initial setting.
- T3 : Fixed to 20ms

Note 1 Excitation check operation is performed at the first servo-on process after the power is turned on for the incremental type and absolute battery type, and when the home return is completed for the simple absolute type to identify the magnetic poles of the motor.

● Servo OFF status

1. Once the actuator stops, no retaining torque will be supplied.
2. The pulse train input, HOME (home return signal), TL (torque-limiting selection signal) and CSTP (external forced stop signal) are all ignored.
3. Output signals SV (ready signal), HEND (home return complete signal) and TLR (torque limiting signal) are all cleared (turned OFF).
4. INP (Positioning Completion Signal)
The INP (Positioning Completion Signal) is OFF when the servo is OFF.

[6] Home Return (HOME, HEND)

PIO signal	Input	Output
	HOME	HEND

The HOME signal is intended for home return.

When the HOME signal is turned ON, the command will be processed at the leading edge (ON edge) of the signal and the actuator will perform home return operation.

Once the home return is completed, the HEND (home return completion) signal will turn ON.

Set the home (enter "0") in the current value register of the host controller (PLC) using the current value preset function, etc., when the HOME signal turns ON.

 Caution:

- (1) The HOME signal is given priority over any pulse train command. Even when the actuator is moving with a pulse train command, it will start home return once the HOME signal is turned ON.
- (2) The HOME signal is processed only at the leading edge (ON edge) of the signal.
- (3) If the SON signal is turned OFF or an alarm is detected during home return, the home return operation will stop. If the servo is turned OFF, the home return command will be cancelled even when the HOME signal remains ON. To perform home return again, therefore, turn the HOME signal OFF and then turn it ON again.
- (4) The actuator can be operated without using this function. If this function is not used, however, management of position data will solely be dependent on the host controller (monitoring soft stroke limit is effective in the home return complete status). Therefore, take the necessary measures to prevent an over-stroke, such as not sending pulse commands with travel distances exceeding the effective stroke or providing external limit switches for stroke end detection, etc., to forcibly stop the actuator.
- (5) For PIO pattern 6, servo-off, switching operation mode setting switch from MANU to AUTO or deviation counter clearing causes HEND to be turned OFF. Perform home return again.

[Home Return Operation of Slider Type/Rod Type Actuator]

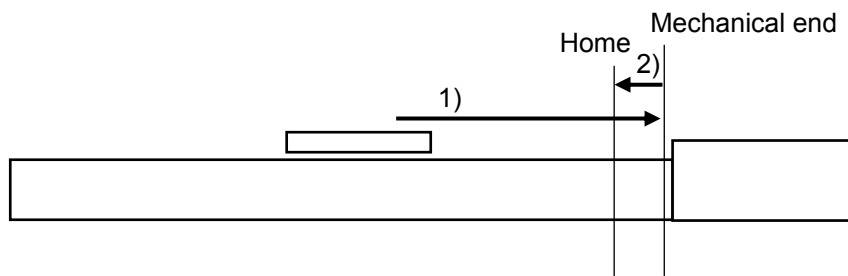

- 1) With the HOME signal being ON, the actuator moves toward the mechanical end at the home return speed.
The moving speed is 20mm/s for most actuators but less than 20mm/s for some actuators.
- 2) The actuator is turned at the mechanical end and stopped at the home position. The moving distance is the value set by Parameter No.22 "Home return offset level".

⚠ Caution: In the home reverse specification, the actuator moves in the reverse direction. Make sure to refer to Section 7.2 [16] when a change to Parameter No.22 "Home return offset level" is required.

[Home Return Operation of Rotary Actuator]

(1) 330° Rotation Specification

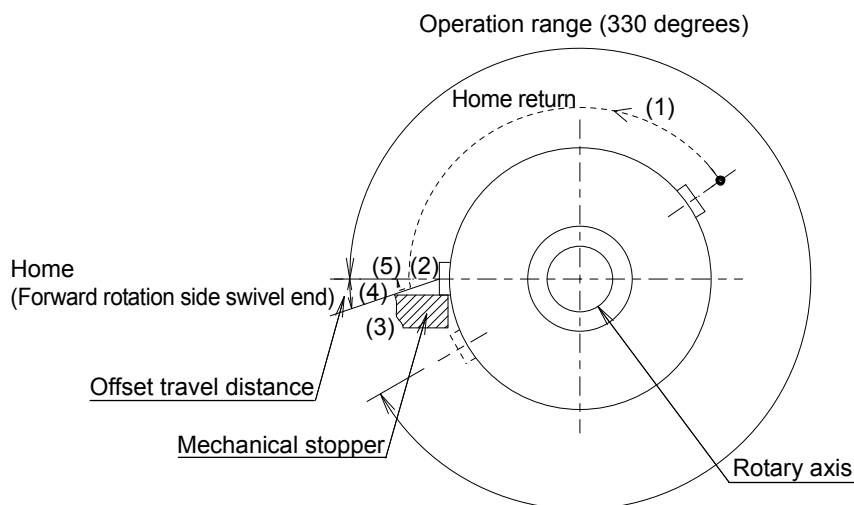

- 1) When home return is commanded, the rotary part rotates in the CCW (counterclockwise) direction as seen from the load side.
The speed is 20 deg/s.
- 2) Detects mechanical stopper.
- 3) It travels in reverse.
- 4) Moves from the position of (3) for the amount set in Parameter No. 22 "Homing Offset" and stops.
- 5) The position stopped in (4) should be the home position.

⚠ Caution: Make sure to refer to Section 7.2 [16] when a change to Parameter No.22 "Home return offset level" is required.

(2) Multi-Rotation Specification

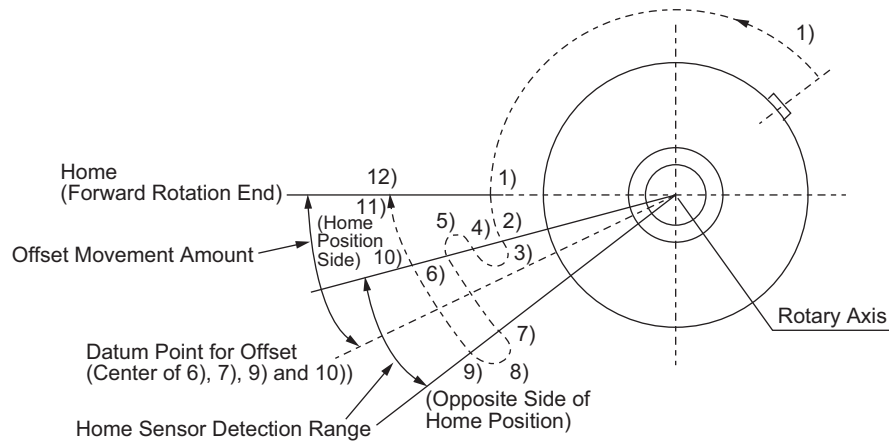

- 1) Once the home-return command is issued, the actuator rotates in CCW (counterclockwise) direction from the view point of the load side. The velocity is 20deg/s.
- 2) Home sensor turns ON.
- 3) Starts reversed rotation.
- 4) Goes back to a point exceeded the home sensor detection range, and confirms the home sensor is turned OFF.
- 5) Starts reversed rotation.
- 6) Confirms the home sensor gets turned ON again.
- 7) Goes to a point exceeded the home sensor detection range on the opposite side of the home position, and confirms the home sensor is turned OFF.
- 8) Starts reversed rotation.
- 9) Confirms the home sensor turns ON.
- 10) Goes to a point exceeded the home sensor detection range on the home position side, and confirms the home sensor is turned OFF.
- 11) Based on the result gained from 6), 7), 9) and 10), the center of the home sensor detection range is calculated.
- 12) Moves for the amount set in Parameter No.22 "Home return offset level" from the position of 11), and stops at the home position.

⚠ Caution: The operation of the reversed rotation type should be in the reversed way. Make sure to refer to Section 7.2 [16] when a change to Parameter No.22 "Home return offset level" is required.

[Home Return Operation of Actuator of Gripper Type]

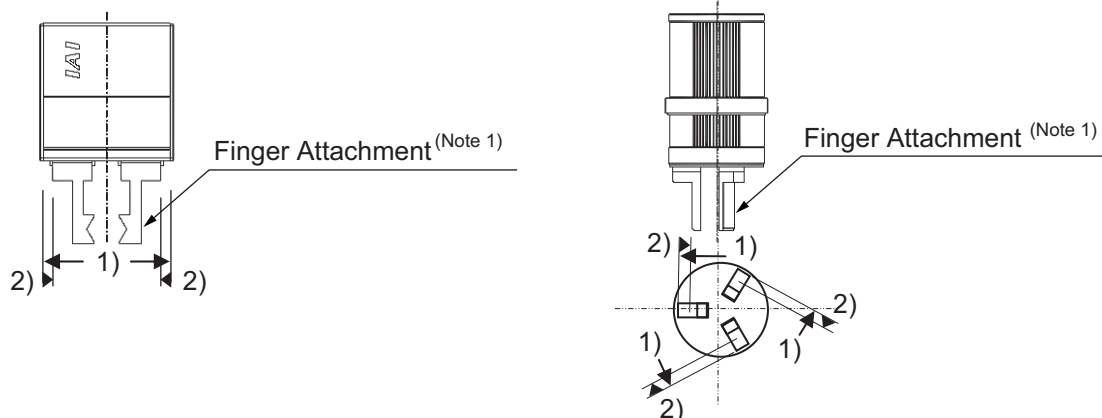

- 1) If the HOME signal is turned ON, the actuator moves toward the mechanical end (to end side) at the home return speed (20mm/s).
- 2) The actuator is turned at the mechanical end and stopped at the home position. The moving distance is the value set by Parameter No.22 "Home return offset level".

Caution: Make sure to refer to Section 7.2 [16] when a change to Parameter No.22 "Home return offset level" is required.

Note 1 Finger attachment is not included in the actuator package. Please prepare separately.

[7] Datum Position Move (RSTR, REND)

PIO signal	Input	Output
	RSTR	REND

RSTR Signal is a command signal to move (Note 1) to the datum position * set at any point. This command is processed at the startup (ON-edge) and operation to the datum position is conducted.

Once the movement to the datum position is complete, output REND (datum position movement complete) signal turns ON (Note2).

For the absolute type actuators with no home-return operation conducted, have the position management of the host controller conducted at this point.

* Set it in Parameter No. 167 only for the absolute type actuators.

Note 1 Movement to the datum position is made under the following conditions.

Position	Pulse train datum position (Parameter No.167 setting position)
Velocity	PIO jog velocity (Parameter No.26 setting position)

Note 2 REND Signal turns off under the following conditions.

- 1) RSTR signal is ON
- 2) When servo is OFF
- 3) ON-edge is detected due to one of the signals of compulsory stop (CSTP), home return (HOME) or deviation counter clearing (DCLR).
- 4) Mode changed from AUTO to MANU

Caution:

- 1) Servo alarm will be generated when RSTR signal is turned ON while HEND is OFF.
- 2) An alarm for DCLR Signal detection in the datum position movement command will be generated if turning RSTR Signal gets turned on while DCLR Signal is on.

[8] Zone (ZONE1, ZONE2)

PIO signal	Output	
	ZONE1	ZONE2

Each of the signals turns ON when the current actuator position is inside the range specified by the relevant parameter.

Two zones, ZONE1 and ZONE2, can be set.

When the current position of the actuator is in ZONE1, it is turned ON if it is in the range of Parameter No.1 "Zone Boundary 1 Positive Side" and Parameter No.2 "Zone Boundary 1 Negative Side", while is OFF when out of the range. These signals are always enabled in the home return complete state and not affected by the servo status or alarm status. (The ZONE2 signal turns ON/OFF according to Parameter No.23 "Zone Boundary 2+" and Parameter No.24 "Zone Boundary 2-".

● Setting values and signal output range

The zone output range varies depending on the difference between the value set for the plus side of the zone and that for the minus side.

- 1) Value set for plus side > value set for minus side: The output signal is set to ON in the range and OFF out of the range.
- 2) Value set for plus side < value set for minus side: The output signal is set to OFF in the range and ON out of the range.

[For Straight Slide Actuators]

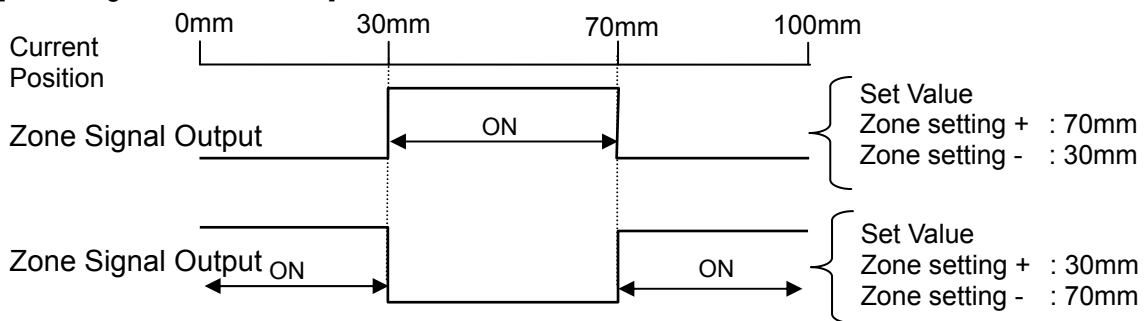

[Operation of rotary actuator of multi-rotation specification in index mode]

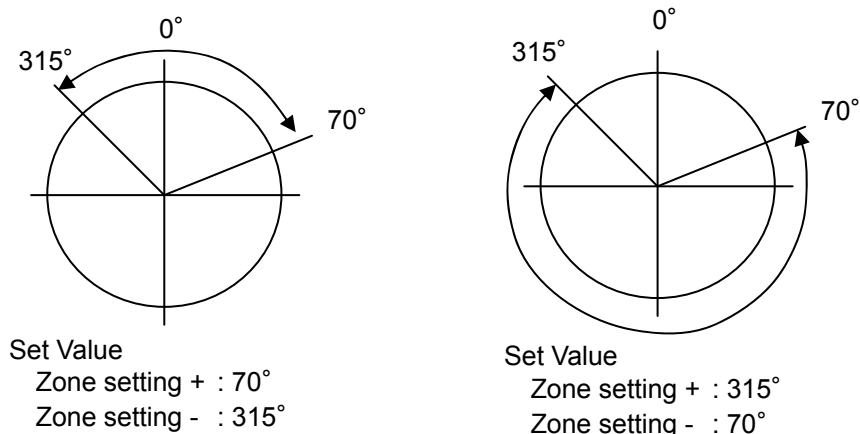

Caution:

- (1) These signals become effective after the coordinate system is established following home return. Turning on the power is not enough to output these signals.
- (2) These signals are not available if the home return function of the controller is not used.
- (3) The zone detection range would not turn ON unless the value exceeds that of the minimum resolution (actuator lead length/800).

[9] Alarm, Alarm Reset (*ALM, RES)

PIO signal	Input	Output
	RES	*ALM

- 1) Alarm signal *ALM is set to ON in the normal status but turned OFF at the occurrence of an alarm at a level equal to or higher than the operation release level.
- 2) Turning reset signal RES ON under occurrence of an alarm at the operation release level allows the alarm ^(Note 1) to be released. The action is taken at the rising edge (ON edge).
- 3) The alarm reset should be done after the cause of the alarm is confirmed and removed. If alarm reset and restart are repeated many times without removal of the cause, a severe failure such as motor burnout may occur.

Note 1 Check the 8.4 Alarm List for details of alarms.

Caution: An alarm of the cold start level cannot be cancelled by RES. Confirm the cause, remove it, and then reboot the unit.

[10] Binary Output of Alarm Data Output (*ALM, ALM1 to 8)

PIO signal	Output	
	*ALM	ALM1 to ALM8

- 1) If an alarm at a level equal to or higher than the operation release level occurs, alarm output signals ALM 1 to 8 output the alarm information in the binary code format.
- 2) The PLC can read the binary code of alarm signal *ALM as the strobe signal to check the alarm information.

○: ON ●: OFF

*ALM	ALM8	ALM4	ALM2	ALM1	Binary Code	Description: Alarm code is shown in ().
○	●	●	●	●	–	Normal
●	●	●	●	○	1	Collision detection (0DF)
●	●	●	○	●	2	Software reset during servo ON (090) Position No. error in teaching (091) PWRT signal detection during movement (092) PWRT signal detection in incomplete home return (093) DCLR signal detection with datum position movement command (095) Servo ON command after encoder FRAM read/write (09C)
●	●	●	○	○	3	Move command during servo OFF (080) Position command in incomplete home return (082) Absolute position move command when home return is not yet completed (083) Movement Command during Home Return Operation (084) Position No. error during movement (085) Move command while pulse train input is effective (086) Position command information data error (0A3) Command deceleration error (0A7)
●	●	○	●	●	4	FAN error detection (0D6) Field bus module not detected (0F3) Mismatched PCB (0F4)
●	●	○	●	○	5	Field bus link error (0F1) Field bus module error (0F2)
●	●	○	○	●	6	Parameter data error (0A1) Position data error (0A2) Unsupported motor/encoder type (0A8)
●	●	○	○	○	7	Excitement detection error (0B8) Home sensor non-detection (0BA) Home return timeout (0BE)

(Note) *ALM Signal is an active low signal. It is ON when the power is applied to the controller, and turns OFF when the signal is output.

○: ON ●: OFF

*ALM	ALM8	ALM4	ALM2	ALM1	Binary Code	Description: Alarm code is shown in ().
●	○	●	●	●	8	Actual Velocity Excessive (0C0)
●	○	●	●	○	9	Overcurrent (0C8) Overvoltage (0C9) Overheat (0CA) Current sensor offset adjustment error (0CB) Control power source voltage error (0CC) Drop in control supply voltage (0CE) Drive source error (0D4)
●	○	●	○	○	11	Command counter overflow (0A4) Command counter overflow in Incomplete home return (0D5) Deviation Overflow (0D8) Software stroke limit exceeded (0D9) Pressing motion range over error (0DC)
●	○	○	●	●	12	Servo error (0C1) Overload (0E0)
●	○	○	●	○	13	Encoder receipt error (0E5) Encoder count error (0E6) A- and B-phase Wire Breaking (0E8) BLA encoder detection (0DE) Absolute encoder error detection 1 (0ED) Absolute encoder error detection 2 (0EE) Absolute encoder error detection 3 (0EF)
●	○	○	○	●	14	CPU error (0FA) Logic error (0FC)
●	○	○	○	○	15	Nonvolatile memory write verify error (0F5) Nonvolatile memory write timeout (0F6) Nonvolatile memory data destroyed (0F8)

(Note) *ALM Signal is an active low signal. It is ON when the power is applied to the controller, and turns OFF when the signal is output.

[11] Brake Forcible Release (BKRL)

PIO signal	Output
	BKRL

The brake can be released while BKRL signal is turned ON.
For the actuator equipped with a brake, the brake can be controlled by turning the servo ON/OFF, however, a release of the brake may be necessary in the case of installing the unit to a system so the slider or rod can be moved by hand.
This operation can be performed not only by the brake release switch on the front panel of the controller, but also by the brake release signal BKRL.

 Warning: (1) Take sufficient care to release the brake. Inappropriate brake release may cause people to be injured and/or the actuator, the work and/or the machine to be damaged.

(2) After the brake is released, always make the brake applied again. Any operation with the brake remaining released is extremely dangerous. The slider or rod may drop to cause people to be injured and/or the actuator, the work and/or the machine to be damaged.

(3) Make certain that this signal is turned OFF (brake is activated) when the power is supplied to the controller.

(4) It is prohibited to switch over between AUTO and MANU while this signal is ON (brake is released).

3.3.3 Pulse Train Input Operation

[1] Command Pulse Input (PP•/PP, NP•/NP)

In the differential type, it is able to have 200kpps of pulse train input at maximum. When the host controller possesses only the pulse output function of the open collector, it is able to input 200kpps pulse at maximum by connecting AK-04 (option).

6 types of command pulse train can be selected. Set the pulse train format in Parameter No.63 and active high/low in Parameter No.64. [Refer to 3.3.4 Settings of Basic Parameters Required for Operation]

⚠ Caution:

- (1) The directions in which the actuator moves upon receiving forward and reverse pulses conform to the pulse count direction set in Parameter No.62.
- (2) As for the forward/reverse directions, pay attention to the host controller setting or PP•/PP and NP•/NP connections.
- (3) Set the actuator acceleration/deceleration on the host controller side.
- (4) The actuator acceleration/deceleration should not exceed the rated acceleration/deceleration of the applicable actuator. [Refer to the actuator's catalog or the appendix in this Instruction Manual for the rated acceleration/deceleration of each actuator.]

* The rotating direction of the motor is defined so that the counterclockwise direction as viewed from the end of the load shaft represents the forward direction.

Command Pulse Train Mode	Input Terminal	In Normal Rotation	In Reverse Rotation	
Negative Logic	Normal Rotation Pulse Train	PP•/PP		
	Reverse Rotation Pulse Train	NP•/NP		
	The normal rotation pulse train shows the motor rotation amount in normal direction, and reverse rotation pulse train shows the motor rotation amount in reverse direction.			
	Pulse Train	PP•/PP		
	Symbol	NP•/NP	Low	High
	The command pulse shows the motor rotation amount and the command symbol shows the rotation direction.			
	A/B Phase Pulse Train	PP•/PP		
The A/B Phase 4-fold Pulse with the phase difference of 90° shows the commands for the rotation amount and direction.				
Positive Logic	Normal Rotation Pulse Train	PP•/PP		
	Reverse Rotation Pulse Train	NP•/NP		
	Pulse Train	PP•/PP		
	Symbol	NP•/NP	High	Low
	A/B Phase Pulse Train	PP•/PP		
A/B Phase Pulse Train	NP•/NP			

⚠ Caution: Consider the electric gear ratio of the host side and that of the controller side via the following calculation.

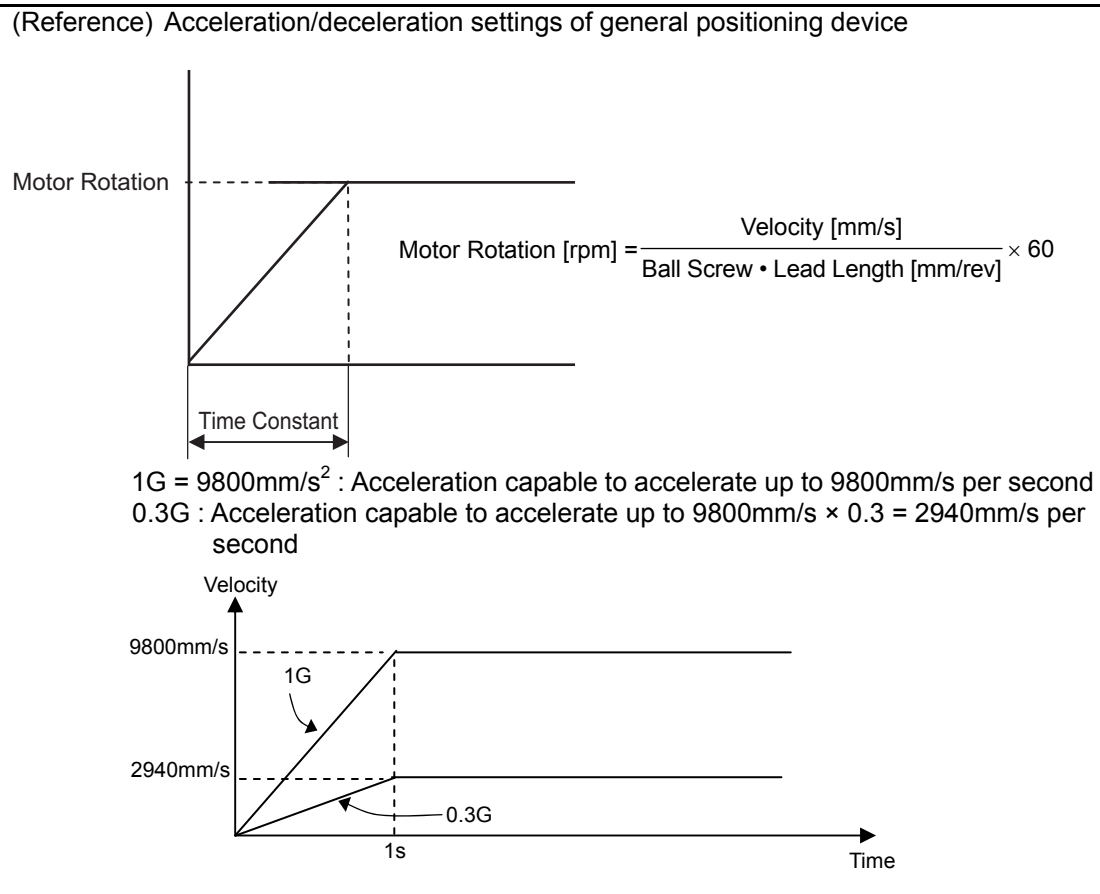

⚠ Caution: Set the acceleration/deceleration speed not to exceed the maximum acceleration/deceleration speed of the actuator. An operation with exceeding condition may cause a malfunction.

[2] Position Complete (INP)

PIO signal	Output
	INP

This signal will turn ON when the remaining travel pulses (accumulated pulses) on the deviation counter enters the positioning width.
 When the servo is ON, this signal turns ON when the accumulated pulses on the deviation counter are within the number of pulses set in Parameter No.10 "Default positioning width".
 This signal is OFF while the servo is OFF.

⚠ Caution:

- (1) This signal will turn ON when the servo turns ON (because positioning is executed at the current position where the servo is ON).
- (2) This signal turns on in response to the deviation (servo lag pulses) and the variance to the command pulse in 1ms.
 Even if the deviation is within the positioning width, the signal would not turn on if there is a variance to the command pulse in 1ms.

[3] Torque Limit Select (TL, TLR)

PIO signal	Input	Output
	TL	TLR

This signal is used to limit the torque of the motor.

While the TL signal is ON, the actuator thrust (motor torque) can be limited to the torque set in Parameter No.57 "Torque limit".

With the TL signal being ON, the TLR signal (torque limiting) will turn ON when the actuator thrust reaches the torque limit.

The TL signal is disabled during home return or forced stop.

<p> Caution:</p> <ul style="list-style-type: none"> • Do not turn the TL signal OFF while the TLR signal is ON. • An excessive deviation (accumulated pulses) may generate while torque is being limited (TL signal is ON) (for example, the actuator may receive a load just like it receive a pressing force in pressing operation and therefore become no longer operable). If the TL signal is turned OFF in this condition, actuator control will start at the maximum torque the moment the signal changes, thus causing the actuator to move suddenly or run uncontrollably. After turning TLR signal ON, perform an operation in the reversed way to confirm TLR signal turns OFF. If the condition is difficult for the reversed movement, turn the servo OFF or clear the deviation counter (by turning DCLR ON).

[4] Deviation Counter Clear (DCLR)

PIO signal	Input
	DCLR

This is the signal to clear the deviation counter that stores the specified pulse until its process is completely finished (positioning is completed) once a command pulse is input.

It is used when the deviation is desired to be cleared after the pressing by TL signal is complete (TLR signal ON). Once the deviation is cleared, TLR signal turns OFF and the condition can be made as it is positioned at the point where the pressing is complete.

<p> Caution: DCLR signal is a signal that is processed at the startup (ON edge). Therefore, input the pulse train while DCLR signal is on and the actuator will operate. Turn this signal ON only when the deviation counter is to be cleared.</p>
--

3.3.4 Settings of Basic Parameters Required for Operation

It is a mandatory parameter to perform an operation.
 (The parameters listed in the table below may only be set if the actuator performs only positioning operation.)

Parameter No.	Parameter Name	Details
65	Electronic Gear Numerator	This parameter determines the unit travel distance of the actuator per command pulse train input 1 pulse.
66	Electronic Gear Denominator	
63	Command Pulse Mode	Specifies the command pulse train input mode.
64	Command Pulse Mode Input Polarity	Sets the type of active high/low of the specified pulse train

[1] Electronic Gear Setting

This parameter determines the unit travel distance of the actuator per command pulse train input 1 pulse.

User Parameter No.65/No.66 Electronic Gear Numerator/Denominator

Name	Unit	Input Range	Initial Value (For reference)
Electronic Gear Numerator	–	1 to 4096	200
Electronic Gear Denominator	–	1 to 4096	15

Determine the movement amount and calculate value for the electronic gear setting by following the formula below:

Linear Axis Unit Travel Distance: Min. Travel Distance Unit (1, 0.1, 0.01mm etc.)/pulse
 Rotary Axis Unit Travel Distance: Min. Travel Distance Unit (1, 0.1, 0.01deg. etc.)/pulse

■ Electronic Gear Formula:

In the case of Linear Axis

$$\frac{\text{Electronic Gear Numerator}}{\text{Electronic Gear Denominator}} = \frac{\text{No. of Encoder Pulses}^{(\text{Note 1})} [\text{pulse/rev}]}{\text{Actuator Lead Length} [\text{mm/rev}]} \times \text{Unit Travel Distance} [\text{mm/pulse}]$$

In the case of Rotary Axis

$$\frac{\text{Electronic Gear Numerator}}{\text{Electronic Gear Denominator}} = \frac{\text{No. of Encoder Pules} [\text{pulse/rev}]}{360 [\text{deg/rev}] \times \text{Rotary Axis Reduction Ratio}} \times \text{Unit Travel Distance} [\text{deg/pulse}]$$

Note 1 : Refer to 9.6 List of Specifications of Connectable Actuators for the encoder pulse of each actuator.

■ Formula for velocity:

The velocity of the actuator can be figured out with the following formula.
 Velocity = Unit Travel Distance × Input Pulse Frequency [Hz]

■ Examples of electronic gear calculations:

To set the unit travel distance to 0.01 (1/100) mm for an actuator a ball screw lead of 3mm, equipped with an encoder of 800pulses/rev.

$$\frac{\text{Electronic Gear Numerator}}{\text{Electronic Gear Denominator}} = \frac{\text{No. of Encoder Pluses [pulse/rev]}}{\text{Ball Screw Lead Length [mm/rev]}} \times \text{Unit Travel Distance [mm/pulse]}$$

$$= \frac{800}{3} \times \frac{1}{100} = \frac{8}{3}$$

The electronic gear numerator is calculated as 8, while the electronic gear denominator is calculated as 3. Based on these settings, the travel distance per command pulse train input pulse becomes 0.01mm.

⚠ Caution:

- The fraction has to be completely reduced so both the electric gear numerator and electric gear denominator can be 4096 or less and make them to be integral numbers. (Do not stop reducing the fraction on the way.)
- Electronic gear numerator and electronic gear denominator on the line axis have to satisfy the following relative formulas.

$$2^{31} \geq \frac{\text{Stroke Length [mm]}}{\text{Ball Screw Lead Length [mm/rev]}} \times \text{No. of Encoder Pluses [pulse]} \times \text{Electronic Gear Numerator}$$

$$2^{31} \geq \frac{\text{Stroke Length [mm]}}{\text{Ball Screw Lead Length [mm/rev]}} \times \text{No. of Encoder Pluses [pulse]} \times \text{Electronic Gear Denominator}$$
- Use rotary actuators of multi-rotation specification within the range where the following formula is satisfied. Moreover, the maximum rotation angle is ±9999 deg (maximum software stroke limit).

$$\pm 2^{31} \geq \frac{\text{Maximum rotation angle [deg]}}{\text{Unit Travel Distance [deg/pulse]}}$$

Maximum rotation angle : Set the usage conditions (MAX. -9999 to 9999deg)
 Unit Travel Distance : Travel distance per command pulse
- Do not set the minimum movement unit out of the encoder resolution ability. If this setting is conducted, the actuator would not start moving until enough command pulse is stored in the encoder resolution error.

$$\text{Encoder resolution for linear axis [mm/pulse]} = \frac{\text{Ball Screw Lead Length [mm/rev]}}{\text{No. of Encoder Pluses [pulse/rev]}}$$

$$\text{Encoder resolution for rotational axis [deg/pulse]} = \frac{360[\text{deg/rev}] \times \text{Rotary Axis Reduction Ratio}}{\text{No. of Encoder Pluses [pulse/rev]}}$$
- Pay attention not to exceed the specification limit when setting the velocity, acceleration and deceleration.
- The pressing operation velocity should be set to the rated pressing velocity described in “9.6 List of Specifications of Connectable Actuators” when it is to conduct the pressing operation.

[2] Format Settings of Command Pulse Train

Set the format of command pulse train in Parameter No.63 and active high/low in No.64.

(1) Command Pulse Mode

No.	Name	Unit	Input Range	Initial Value
63	Command Pulse Input Mode	-	0 to 2	1

Command Pulse Train Mode	Input Terminal	In Normal Rotation	In Reverse Rotation	Setting Value of Parameter No. 63
Negative Logic	Normal Rotation Pulse Train	PP*/PP		2
	Reverse Rotation Pulse Train	NP*/NP		
	The normal rotation pulse train shows the motor rotation amount in normal direction, and reverse rotation pulse train shows the motor rotation amount in reverse direction.			
	Pulse Train	PP*/PP		1
	Symbol	NP*/NP	Low High	
	The command pulse shows the motor rotation amount and the command symbol shows the rotation direction.			
Positive Logic	A/B Phase Pulse Train	PP*/PP		0
		NP*/NP		
	The A/B Phase 4-fold Pulse with the phase difference of 90° shows the commands for the rotation amount and direction.			
	Normal Rotation Pulse Train	PP*/PP		2
	Reverse Rotation Pulse Train	NP*/NP		
Pulse Train	PP*/PP		1	
Symbol	NP*/NP	High Low		
A/B Phase Pulse Train	PP*/PP		0	
	NP*/NP			

(2) Command Pulse Mode Input Polarity

No.	Name	Unit	Input Range	Initial Value
64	Command Pulse Input Mode Polarity	-	0 to 1	1

Setting 0 : Positive logic

Setting 1 : Negative logic

[3] Pulse Train Datum Position (Parameter No. 167)

No.	Name	Unit	Input Range	Initial Value
167	Pulse Train Datum Position	mm	-9999.99 to 9999.99	0

In the condition of the Pulse Train Control Mode (PIO pattern 7 selected), an operation is made with the position at the this parameter set as the datum position. It is used to Pulse Train Control for the absolute type actuator.

3.3.5 Parameter Settings Required for Advanced Operations

Depending on systems and/or loads, set the following parameters if necessary.

[1] Position Command Primary Filter Time Constant

No.	Name	Unit	Input Range	Initial Value
55	Position command primary filter time constant	ms	0.0 to 100.0	0.0

The acceleration/deceleration of the actuator can be set in S-shaped curve with this parameter setting. (It is not the S-shaped acceleration/deceleration function.)

If command pulse train is input at a certain frequency, the actuator is accelerated/decelerated slowly depending on the time constant.

The actuator moves by the number of command pulses.

Even if the host controller (PLC etc.) has no acceleration/deceleration function or the frequency of command pulses varies rapidly, the actuator can be accelerated/decelerated smoothly.

The delay in positioning stabilizing time requires approximately 3 times longer than the set value after the command pulse input stop. If the set value is 100ms, the stabilizing time would be approximately 300ms.

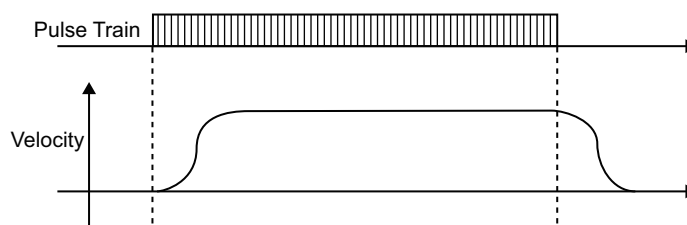

[2] Torque Limit

No.	Name	Unit	Input Range	Initial Value
57	Torque Limit	%	0 to 70	70

Set a desired torque limit used in the torque limit input signal (TL), which is an external input signal.

Set a desired torque as a percentage of the rated thrust representing 100% (the rated thrust is specified in the catalog).

When the external torque-limit input signal (TL) turns ON, the torque will be limited according to the setting.

Once the torque current reaches a level corresponding to the specified torque limit, the torque limiting signal (TLR) will be output as an external output signal.

[3] Clearing Deviation During Servo OFF or Alarm Stop

No.	Name	Unit	Input Range	Initial Value
58	Clearing deviation during servo OFF or alarm stop	-	0 to 1	1

You can select whether to enable or disable the function to clear the deviation when the servo is OFF or the actuator is stopped due to an alarm.

Setting 0: Disable

Setting 1: Enable

[4] Deviation Error Monitor During Torque Limiting

No.	Name	Unit	Input Range	Initial Value
59	Deviation error monitor during torque limiting	–	0 to 1	0

You can select whether to enable or disable the function to monitor deviation while torque is being limited (the TL signal is ON).

By enabling this function, you can have the controller output an error while torque is being limited, if a deviation equal to or exceeding the specified value.

Setting 0: Disable

Setting 1: Enable

[5] Deviation Counter Clear Input

No.	Name	Unit	Input Range	Initial Value
60	Deviation Counter Clear Input	–	0 to 1	0

You can select whether to enable or disable the function to clear the deviation.

Disable this function in conditions where torque must be limited (pressing is not performed).

Setting 0: Disable

Setting 1: Enable

[6] Torque Limit Command Input

No.	Name	Unit	Input Range	Initial Value
61	Torque limit command input	–	0 to 1	0

Torque control of the motor with the value set in Parameter No. 57 Torque Control Value can be performed with PIO (TL Signal ON) from the host system. In this parameter, a choice can be made from using (make activated) TL Signal (Torque Limiting Signal) and not using (make inactivated) the signal.

Setting 0: Disable

Setting 1: Enable

[7] Pulse Count Direction

No.	Name	Unit	Input Range	Initial Value
62	Pulse count direction	–	0 to 1	Set individually

You can set the direction in which the motor turns according to command pulses.

Setting 0: Forward rotation

Setting 1: Reverse rotation

[8] Compulsory Stop Input

No.	Name	Unit	Input Range	Initial Value
67	Compulsory Stop Input	–	0 to 1	0

Compulsory stop of the actuator can be performed with PIO (CSTP Signal ON) from the host system. In this parameter, a choice can be made from using (make activated) CSTP Signal (Compulsory Stop Input Signal) and not using (make inactivated) the signal.

Setting 0: Disable

Setting 1: Enable

[9] Command Output Complete Judgement Time in Non-Positioner Mode

No.	Name	Unit	Input Range	Initial Value
187	Command Output Complete Judgement Time in Non-Positioner Mode	ms	0 to 255	0

It is to be set when low velocity operation ^(Note 1) is conducted in Pulse Train Control Mode.

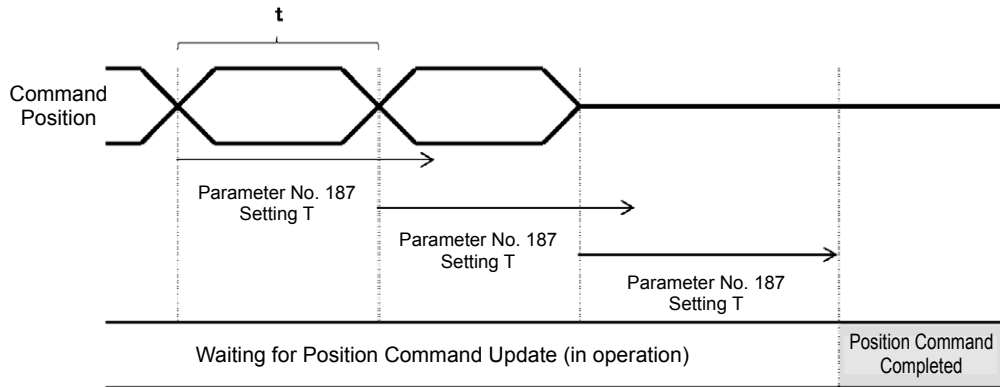

An actuator waits for the next position command for the duration of the time set in this parameter (T in figure above) after the position command input from the host controller (PLC). It should be judged positioning completed when there is no command from the host controller found after the time T has passed and also the deviation is within the range of the positioning band, and the complete signal (INP) should be output.

Therefore, if the time T is shorter than the time pitch that the position command is to be sent (t in figure above), it should be judged as the positioning completed even during operation, and the complete signal (INP) gets output. (Figure (1) below) At this moment, the actuator would perform the torque remaining operation for positioning stop [Refer to 7.2 [9]], thus the movement could not get smooth.

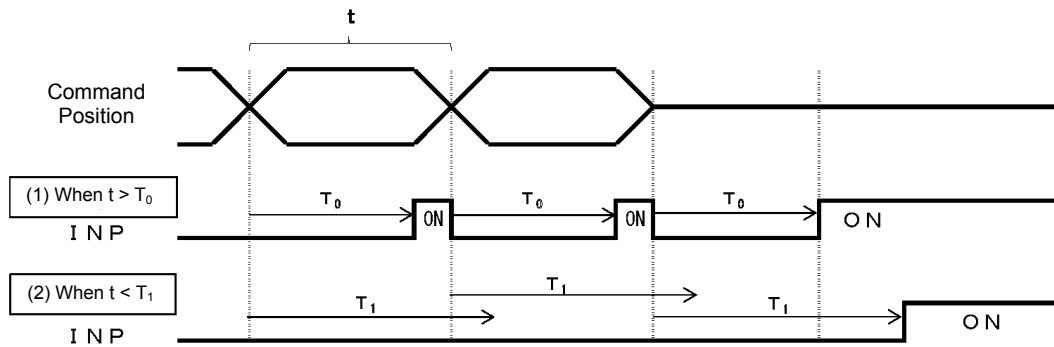

In case of (1), it is necessary to set the parameter setting T₀ longer than t. Figure out the setting value by following the formula below.

[How to Calculate Setting Value]

Refer to “9.6.1 Specifications for Actuators” for the encoder pulse of each actuator.

In the case of Linear Axis

$$T = \frac{\text{Lead Length} \times \text{Electronic Gear Numerator (Parameter No. 65)} \times 2000}{\text{No. of Encoder Pules} \times \text{Electronic Gear Denominator (Parameter No.66)} \times \text{Min. Use Velocity}} \text{ (Note 2)}$$

In the case of Rotary Axis

$$T = \frac{360 \times \text{Rotary Axis Reduction Ratio} \times \text{Electronic Gear Numerator (Parameter No. 65)} \times 2000}{\text{No. of Encoder Pules} \times \text{Electronic Gear Denominator (Parameter No. 66)} \times \text{Min. Use Velocity}} \text{ (Note 2)}$$

If the calculation result is larger than 1, set a rounded up value.
It is not necessary to change the setting from the initial if the calculation result is 1 or less.

Note 1 It is necessary to make a change when low velocity operation with the movement amount below 2 pulses in 1ms.

Note 2 Min. Use Velocity···The slowest speed to perform operation

Chapter 4 Field Network

Applicable for the field network shown in the list below.

Except for RS485 (Modbus), it is the option which can be selected when purchasing. It cannot be changed after the product is delivered.

Also, for the field network other than RS485, PIO cannot be equipped. And Pulse Train Mode cannot be operated.

[1] PCON-CB/CFB Type

Field Network Name	Description	Details
CC-Link	Control of the actuator is available with I/O communication using the control signals same as those for PIO or the numerical data communication.	Refer to the other ME0254 ^(Note1)
CC-Link IE Field		Refer to the other ME0389 ^(Note1)
CompoNet		Refer to the other ME0220 ^(Note1)
DeviceNet		Refer to the other ME0256 ^(Note1)
EtherCAT		Refer to the other ME0273 ^(Note1)
EtherNet/IP		Refer to the other ME0278 ^(Note1)
MECHATROLINK- I / II		Refer to the other ME0221 ^(Note1)
PROFIBUS-DP		Refer to the other ME0258 ^(Note1)
PROFINET IO		Refer to the other ME0333 ^(Note1)
MECHATROLINK-III	Synchronized control of several actuators in highly constant periodicity is available.	Refer to the other ME0317 ^(Note1)
RS485	Actuator is controlled with using a general protocol "Modbus" communication.	Refer to the other ME0162 ^(Note1)

Note 1 PCON-CB/CFB are the slave units (slave stations). Check the instruction manual of the master unit of each supplier and PLC to be mounted for the details of each network. For the instruction of the field network for PCON-CB/CFB, the instruction manual is provided separately. Use the manual together with this manual.

[Reference] Wiring Layout of Field Network (for Field Network type)

Follow the instruction manual of the master unit and PLC consists of each field network for the details of how to perform connections.

1) CC-Link Connection Type

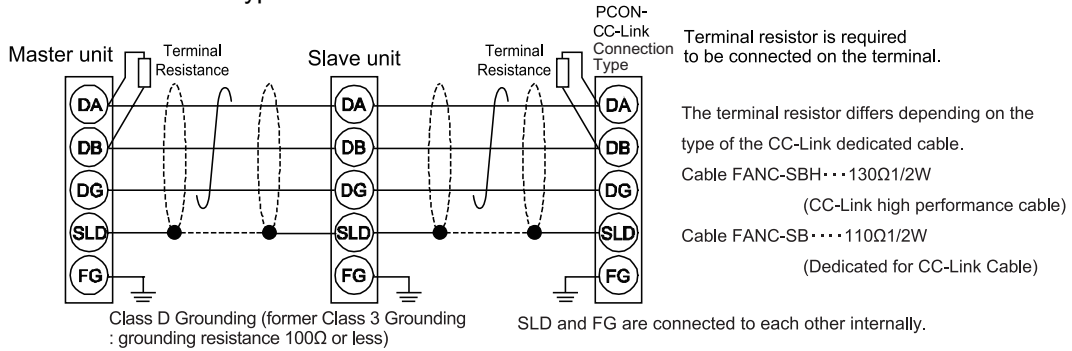

2) CC-Link IE Field Connection Type

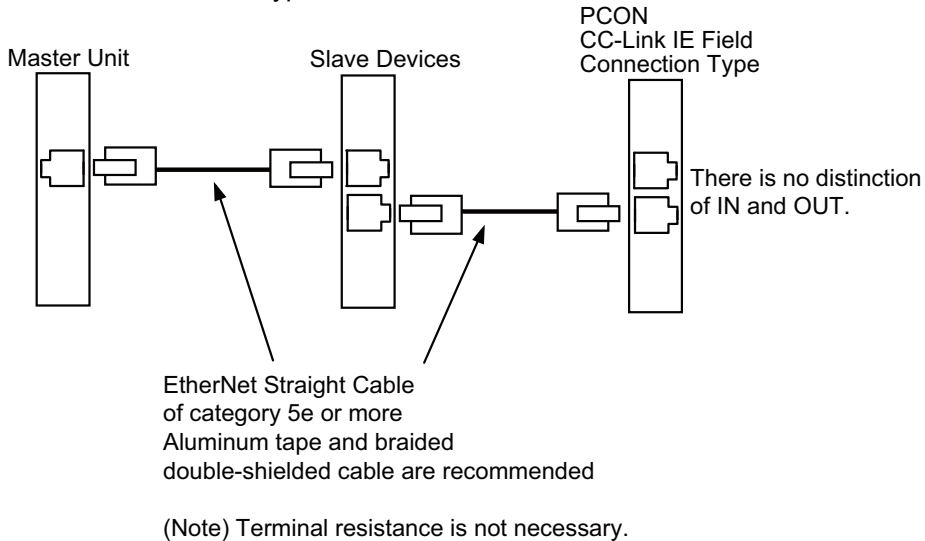

3) CompoNet Connection Type

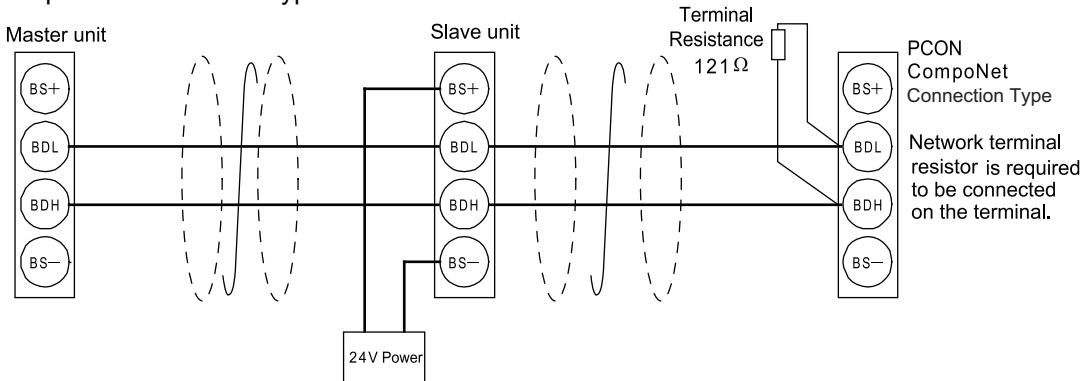

Power needs to be supplied separately for the slave devices that require communication power supply.
Even though communication power is not necessary to be supplied, there should be no problem if communication power is supplied.

4) DeviceNet Connection Type

Terminal resistor is required to be connected on the terminal.

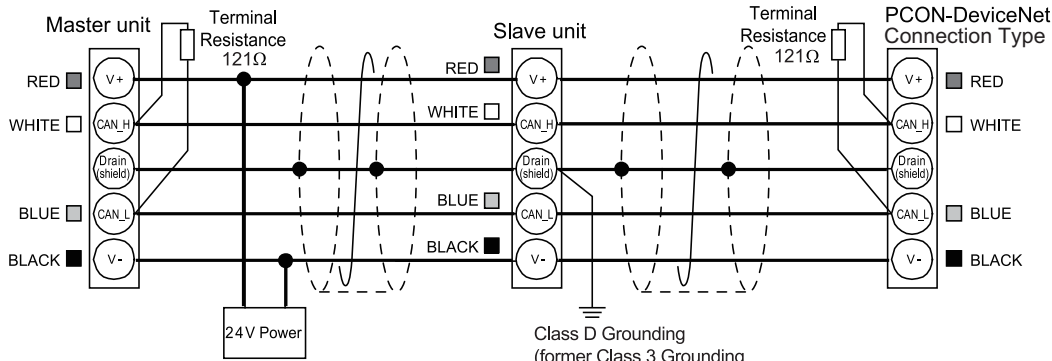

Communication power needs to be supplied externally.

5) EtherCAT Connection Type

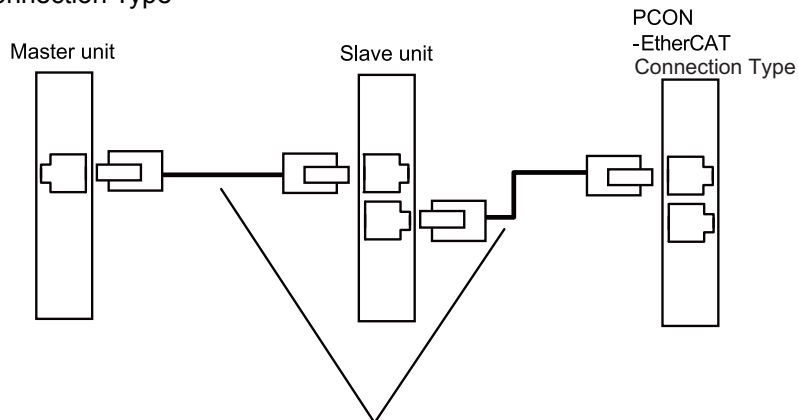

EtherNet straight cable of category 5 or above
Aluminum tape and braided double-shielded cable are recommended

(Note) Terminal resistor is not necessary.

6) EtherNet/IP Connection Type

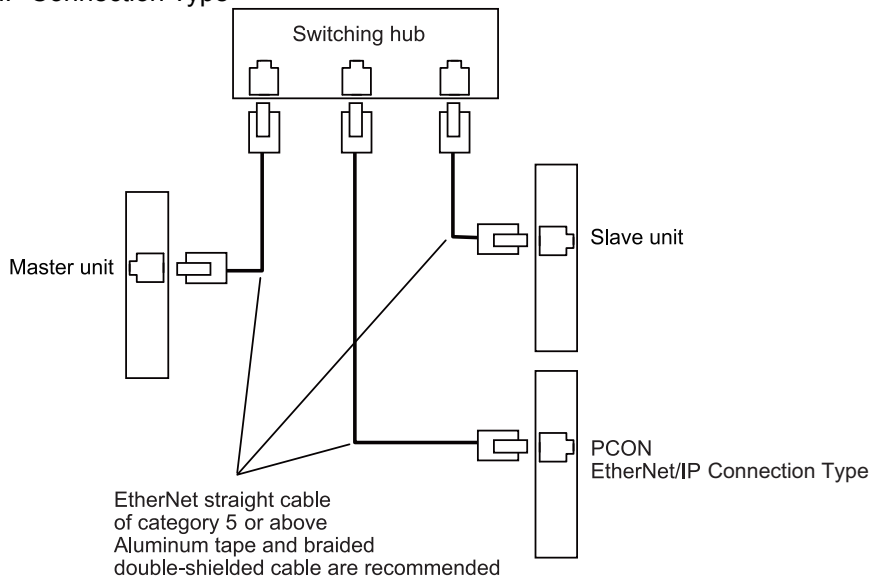

7) MECHATROLINK- I / II Connection Type

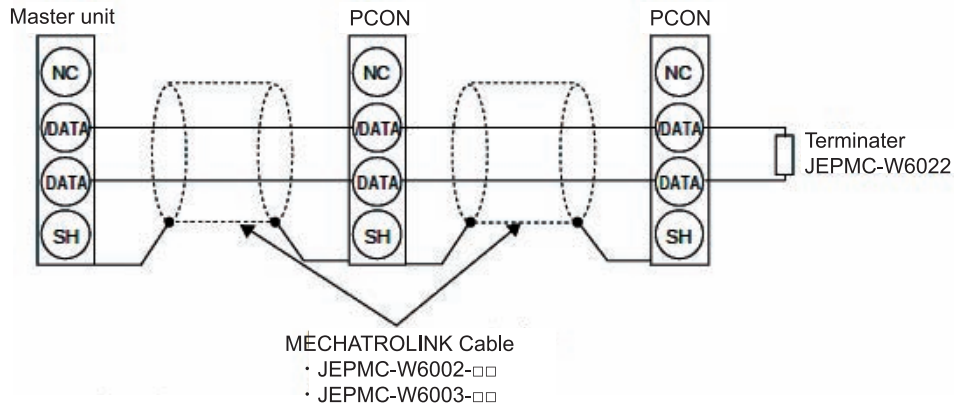

8) PROFIBUS-DP Connection Type

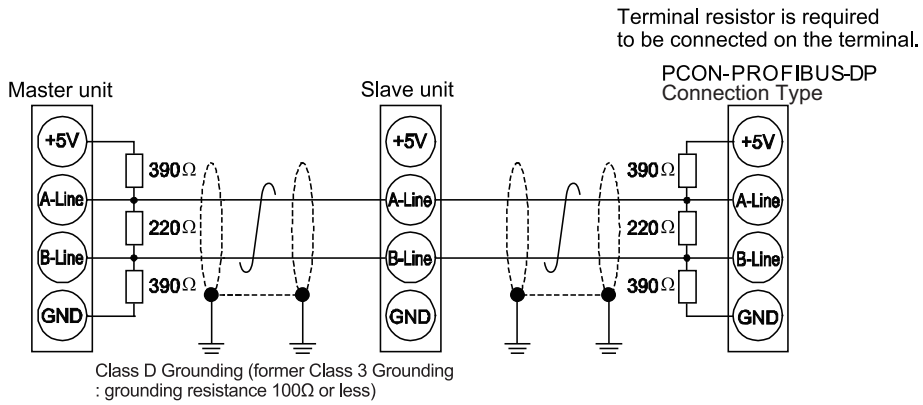

9) PROFINET IO Connection Type

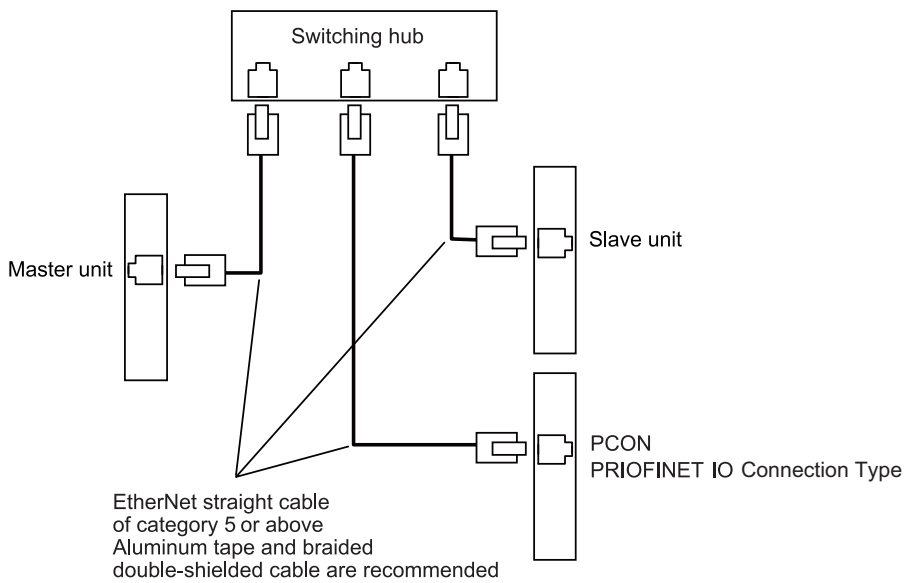

10) MECHATROLINK-III Connection Type

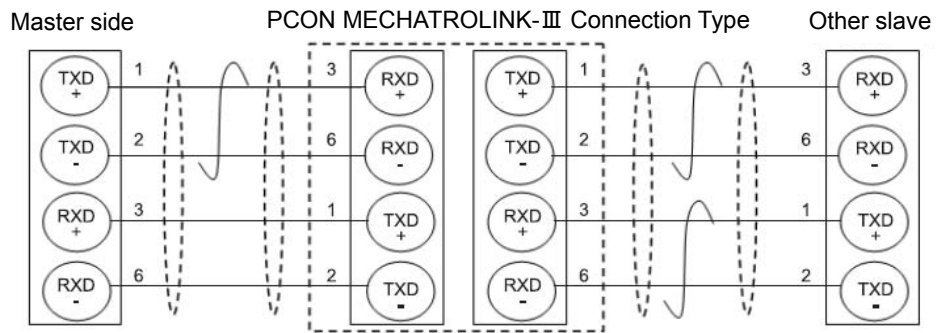

POWER CON **PCON-CB** --- ---

Chapter 5 Other Features

5.1 Collision Detection Feature

This controller is equipped with a feature to stop immediately when the actuator is hit on an object during operation.

Understand this chapter well to avoid any trouble in operation and safety.

Collision detection feature is a feature that stops the operation by generating an alarm and turning OFF the servo when the command current exceeds the set value. The range for detection also can be set.

Warning: This feature is a supportive feature to reduce the damage to a work piece in case of an emergency. It does not mean to compensate in any unexpected damage. The setup of this feature is necessary to be adjusted to an expected collision, and the optimum value differs depending on the system. Well confirm the status before use.

5.1.1 Collision Detection Judgement

Judgment is made as a collision when the current position is in the range of the position zone, for longer than the time set in the parameter *1 and the current has exceeded the threshold *2, and it turns ON PIO Load output judgment (LOAD) signal *3 and turns the servo OFF after generating the collision detection alarm.

*1 Parameter No.50 Load output judgment time

*2 "Threshold" in the positioner table or the load current threshold indication in Full Direct Mode in the field network type.

◎Example of judgement (when judgment time is 255ms)

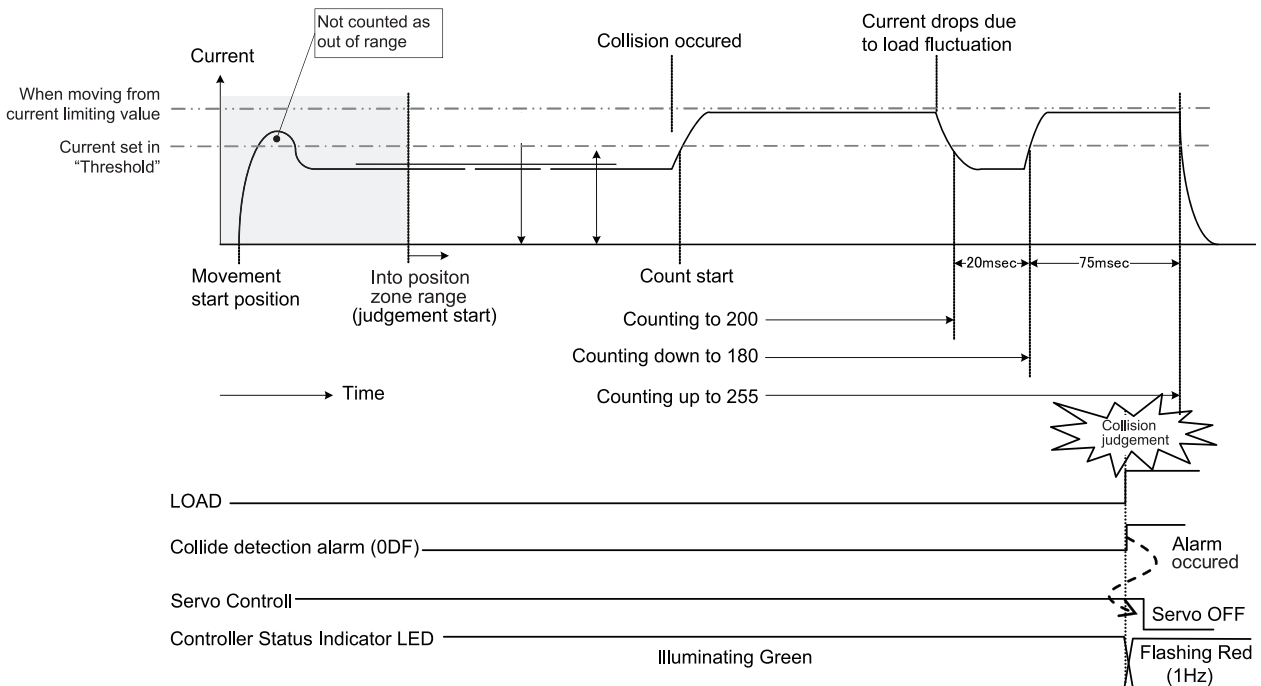

5.1.2 Settings

Have the following settings established when using following function.

1) Select to use feature

Setting can be established in the parameters. Setting of parameter " No.168 Collision Detection Feature"

Setting value	Operation status	Alarm level
0	Detection not to be conducted	-
1	Detection is conducted in position zone setting range.	Operation release level
3 (Note 1)	Detection is conducted in position zone setting range, but is not conducted in the following conditions. In this setting, it can avoid a mistake to detect the current during acceleration. <ul style="list-style-type: none"> • The first movement after releasing from a pause • Movement from a stop in the position zone range 	
5	Detection is conducted in position zone setting range.	Message level
7 (Note 1)	Detection is conducted in position zone setting range, but is not conducted in the following conditions. <ul style="list-style-type: none"> • The first movement after releasing from a pause • Movement from a stop in the position zone range 	

Note 1 In this setting, it can avoid a mistake to detect the current during acceleration.

2) Setting of Detection Current

Setting is made by inputting 0 (0%) to 100 (100%) in "Threshold" cell in the position table. Detection is not conducted if set to 0.

3) Setting of Adjustment time

Setting can be established in the parameters. Setting of parameter " No.50 Load Output Judgment Time"
 Position zone : 0 to 9999 [ms] (Initial Value 255ms)

4) Setting of Adjustment Range (position zone)

Set the range in "Zone +" and "Zone -" in the position table. Set a small value in "Zone +" and "Zone -".
 Position zone : 0.00 to Actuator Stroke Length [mm]

5.1.3 Adjustment

Refer to the following when performing an adjustment.

1) Adjustment range : Avoid the acceleration range, which requires high current", and set the range with possibility that collision can occur.

2) Detection Current : Considering the movement velocity and weight of a work piece, set a low value in the range that detection mistake would not occur. (Set it slightly higher than the current necessary for constant velocity movement, and tune little by little.)

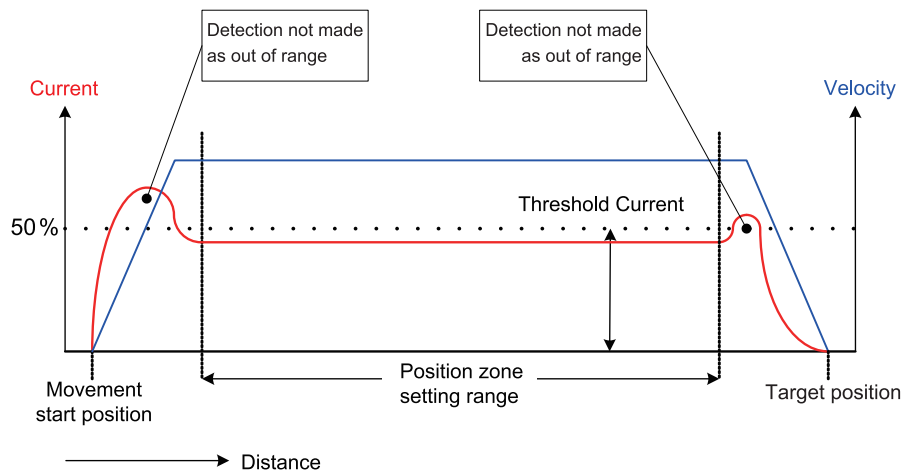

5.2 Power-saving Function

5.2.1 Automatic Servo-off and Full Servo Functions

This controller possesses Automatic Servo-off and Full Servo functions to reduce the power consumption while the actuator is stopped. Read the description in this chapter carefully to save power so that the controller can be operated safely.

Automatic Servo-off function automatically turns the servo OFF in certain time after positioning process is finished. The next positioning command is issued to turn the servo ON automatically and achieve the positioning. No holding current flows in the stop state to allow the power consumption to be saved.

3 types of patterns can be set for the time since positioning complete until servo turned OFF, and either one can be selected.

In the Full Servo Function, it is able to reduce the power consumption by controlling the pulse motor which consumes comparatively high current during a stop ^(Note 1). (RCP6 is can not be used full servo function)

For the power saving function, which of Parameter No.53 or "Stop Mode" in the position table is to be used is determined by the actuator condition. The details are shown below.

Note1 Certain amount of stop current is applied to restrain small vibration during a stop to stop completely. Also, positioning should complete once the encoder value reaches ± 4 counts of the target position for pulse motor.

(Return operation will be performed even for misalignment of 1 count when the full servo feature is activated.)

High-resolution encoder type pulse motor will make recovery operation even for one count of misalignment.

Setting	PIO Pattern 0 to 4	PIO Pattern 5
Standby after home return is complete (Positioning to the target point is not done)	Power saving function executed with the values set in Parameter No.53 (Stop Mode of the position number is invalid)	
Standby with the servo turned ON after the power is supplied (Positioning to the target point is not done)		Power saving function executed with the values set in Parameter No.53 (Stop Mode of the position number is invalid)
Standby after the positioning is complete to the target position set in the position table	Power saving function executed with the values set in "Stop Mode" in each position number (Setting of Parameter No.53 is invalid)	

 **Warning:** Do not use this function if the automatic servo-off is followed by pitch feed (relative movement). Servo ON/OFF may cause slight position shift to occur. If position shift occurs due to external force during servo-off, positioning to the correct position is disabled. It is because pitch feed is operated based on the position at start used as the base point.

 **Caution:** Automatic servo-off function is not effective while in pressing operation. Do not use. It becomes effective at completion of positioning. In pressing, the function becomes effective only when miss-pressing occurs (the status at the completion of operation without pressing is the same as that at the completion of positioning). No retaining torque is provided in automatic servo-off. The actuator can move with an external force. Pay attention to the interference to the peripherals and the safety in the installation.

 **Caution:** When an operation is made with jog or inching while in operation with the full servo function, the full servo function will be inactivated. If a movement is made again on the position number that the full servo function is set valid, the full servo function will be activated.

- (1) Setting of periods taken until automatic servo-off
 Three periods from completion of positioning to automatic servo-off can be set in the following parameters in seconds [sec].

Parameter No.	Description
36	Auto Servo Motor OFF Delay Time 1 (Unit: sec)
37	Auto Servo Motor OFF Delay Time 2 (Unit: sec)
38	Auto Servo Motor OFF Delay Time 3 (Unit: sec)

- (2) Set of power-saving mode
 Select a proper power-saving mode from the conditions below. Set the corresponding value in the stop mode or parameter No.53 of the position table. (RCP6 is can not be used full servo function)

Set Value	Operation after completion of positioning
0	Servo ON not changed
1	Automatic servo-off in a certain time (set in Parameter No.36)
2	Automatic servo-off in a certain time (set in Parameter No.37)
3	Automatic servo-off in a certain time (set in Parameter No.38)
4	Full Servo Control
5	Full-servo control for a certain time (value set in Parameter No.36) and then automatically turning servo-off
6	Full-servo control for a certain time (value set in Parameter No.37) and then automatically turning servo-off
7	Full-servo control for a certain time (value set in Parameter No.38) and then automatically turning servo-off

- (3) Status of positioning complete signal in selection of automatic servo OFF
 Automatic servo-off causes the actuator to be in other than the positioning complete state due to the servo-off. Positioning complete signal (PEND) is turned OFF. Changing the PEND signal to the in-position signal judging whether the actuator is stopped within the positioning width zone instead of the positioning complete signal allows PEND not to be turned OFF during servo-off.
 This setting is reflected on complete position numbers PM1 to PM** in PIO patterns 0 to 3 confirming the positioning complete position No. or current position numbers PE* in PIO patterns 4.
 Define the setting in Parameter No.39.

Value set in Parameter No.39	Content of PEND signal	Signal outputs during automatic servo OFF		
		PEND	PM1 to PM**	PE**
0	Positioning Completion Signal	OFF	OFF	OFF
1	In-position Signal	ON	ON	ON

(Note) The SV on the front panel blinks green during the automatic servo-off.

[For Parameter No.39 = 0]

Operation of actuator	Positioning operation	Automatic servo OFF standby	Servo OFF	Positioning operation
Servo Condition	ON	ON	OFF	ON
Completed Position No. Output (Current position number output)	PM1 to ** = 0 (PE** = OFF)	PM1 to ** = Output (PE** = ON)	PM1 to ** = 0 (PE** = OFF)	PM1 to ** = 0 (PE** = OFF)
Positioning Completion Signal PEND	OFF	ON	OFF	OFF

[For Parameter No.39 = 1]

Operation of actuator	Positioning operation	Automatic servo OFF standby	Servo OFF	Positioning operation
Servo Condition	ON	ON	OFF	ON
Completed Position No. Output (Current position number output)	PM1 to ** = 0 (PE** = OFF)	PM1 to ** = Output (PE** = ON)	PM1 to ** = 0 Output (PE** = ON)	PM1 to ** = 0 (PE** = OFF)
Positioning Completion Signal PEND	OFF	ON	ON	OFF

5.2.2 Automatic Current Reduction Feature

This feature reduces the current at stop gradually when the actuator is able to keep staying at the same stop position (condition with no deviation) after stopping for positioning. In case the actuator has moved, the current at stop increases gradually until the stop condition gets retained.

In case the actuator is able to keep staying at the same stop position, the current at stop is reduced thus it leads to power saving.

Feature Flow

- 1) Stop completely after moving to target position (This feature will not start working until there is no position deviation.)
- 2) Current at stop gets fluctuated depending on if there is position deviation or not.
Position Deviation = 0: Current at stop decreases by certain amount
Position Deviation \neq 0: Current at stop increases by certain amount

Fluctuation of current at stop is implemented in the following range.

(Lower Limit) Setting value ^{*1} for each actuator \leftrightarrow (Upper Limit) Parameter value ^{*2}

*1 It is approximately 15% of the rated current as a reference.

*2 Current limit value at positioning stop

This feature can be set valid/invalid in Parameter No. 182 "Automatic Current Reduction Feature".

Enable=1, Disable=0

 **Caution:** This feature is available to use regardless of the encoder resolution, however, for the high-resolution battery-less absolute encoder, the current at stop may remain at the maximum because of detection of slight position deviation and may not be able to obtain the effect.

5.3 Actuator Information Management Function

IAI actuators have the following 3 types of information management function. This information is saved in the actuator and can be confirmed through the controller.

[Individual identification information]

The actuator's serial number and model information have been written to the actuator at the factory shipment.

[Maintenance Information]

The actuator's maintenance information is saved in the actuator.

When the actuator is returned to our company for repair, this allows us to acquire more information, which can be useful for repair and failure analysis.

[User memo]

It has a memo function that allows the customer to freely enter information such as "For process ■■ of device ●●" or "Motor was exchanged on January 1st 20▲▲". The entered information will be saved in the actuator.

It can be used for maintenance and repair.

5.3.1 Actuators with information management function supported

Actuators that satisfy the following 2 conditions support the information management function.

- High resolution battery-less absolute encoder compatible model
- Models whose function version supports the information management function

[High resolution battery-less absolute encoder compatible model]

The following series types are mainly applicable.

RCP6-SA/WAS/TA/RA/RAA/WRA, RCP6CR-SA/WAS, RCP6W-RA/RAA/WRA

For details, see the “Chapter 9 Appendix 9.7 List of Actuators That Support Information Management Function”.

[Models whose function version supports information management function]

Models whose function version is “R1” or later

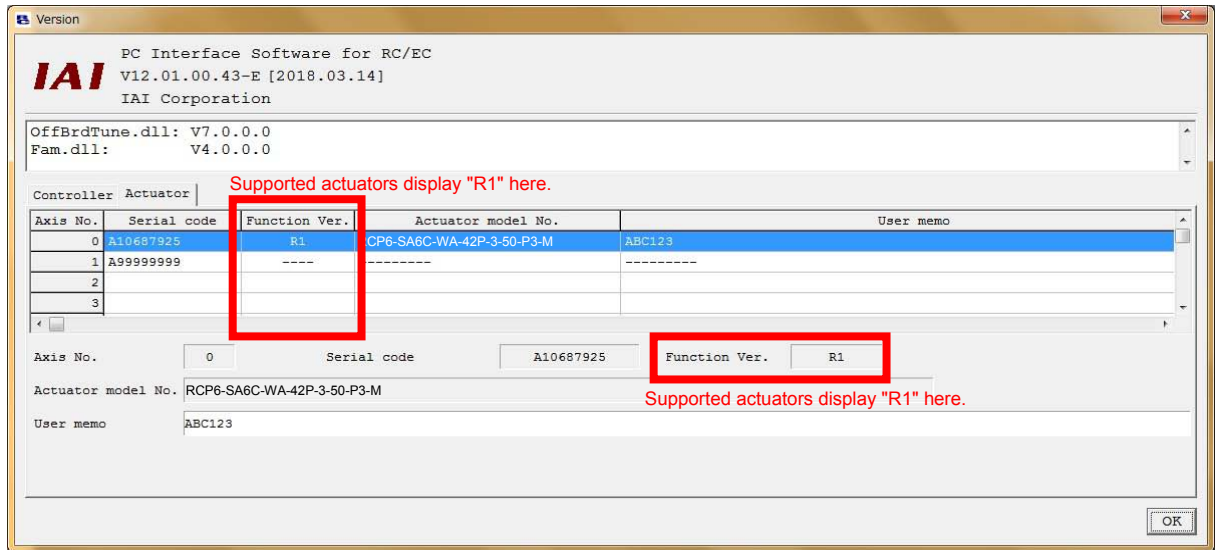

5.3.2 Actuator information management function

Details of the 3 function types are as follows.

[Individual identification information]

Using the teaching pendant or PC software for RC/EC, you can check the information written on the actuator connected to the controller.

Serial No., function version, and model number are written at factory shipment.

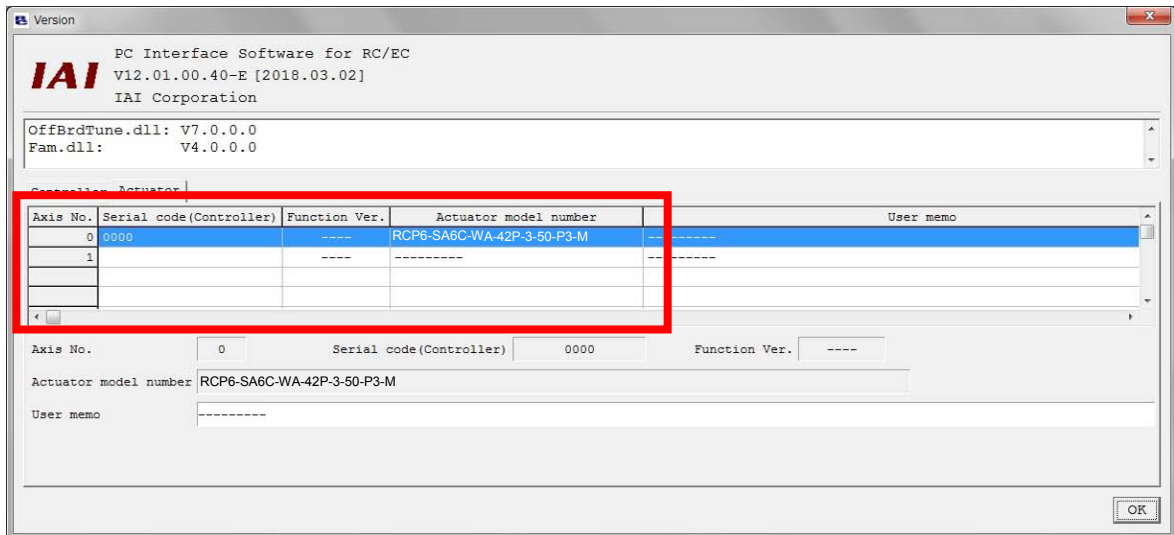

For teaching tool operation, refer to the following instruction manuals.

Reference

PC software operating method
Teaching pendant operating method



PC software manual (ME0155)
Touch panel teaching pendant manual
TB-02/02D (ME0355)
TB-03 (ME0376)

[Maintenance Information]

In addition to the information saved in the controller (total travel count, total travel distance), the actuator maintenance information (travel distance, lubrication time, replacement time, etc.) can be managed. The actuator maintenance information is saved in the actuator.

Maintenance Information[Axis No.0]

Units of total moving distance
 [km] [m]

Current state

Total moving count	81	<<<	<input type="text"/>	Send	
Total moving distance[km]	0	<<<	<input type="text"/>	Send	
Travel distance after lubrication[km]	43	<<<	<input type="text"/>	Send	
Last time lubricated	18/02/01 13:48:17	<<<	18/03/06	19:15:24	Send
Actuator replacement time	18/02/01 11:26:02	<<<	18/03/06	19:15:24	Send
Total driving time of fan[day]	0				

Signal output timing setting

Total moving count threshold	0	<<<	<input type="text"/>	Send
Total moving distance threshold[km] (Measure of grease supply)	0	<<<	<input type="text"/>	Send
Overload warning level	100	<<<	<input type="text"/>	Send

! Notice

- To update the actuator's maintenance information, update the information with the teaching tool. Otherwise, restart the controller or perform a software reset.
- If the unit is operated continuously without turning the controller off, information updates to the actuator will not be performed. Take note.

[User memo]

Any 124-byte character string (124 1-byte characters, 62 2-byte characters) can be saved.
 You can confirm, enter and edit using the teaching tool.

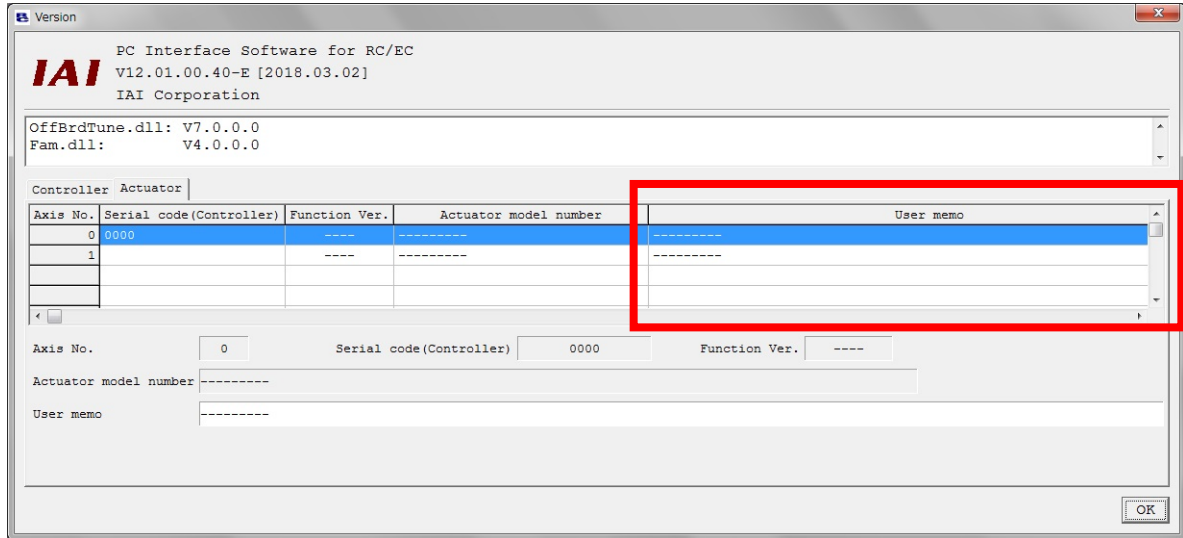

5.3.3 Parameters for actuator information management function setting

Parameters related to this function are as follows.

[Actuator recognition function (parameter No. 192)]

No.	Name	Unit	Input Range	Default factory setting
192	Actuator recognition function	-	0: Disabled 1: Enabled	0

Invalid/valid of Actuator Information Manager Feature should be set up.

When the actuator is not applied for Actuator Information Manager Feature or this feature is not to be used, do not change the setting from 0 (Initial setting).

Alarm Code 0A1 "Parameter data error" should occur when this parameter is set to 1 and an actuator not applicable for Actuator Information Manager Feature is connected.

Chapter 6 Absolute Reset and Absolute Battery

6.1 Absolute Reset

In Simple Absolute Type and Battery-less Absolute Type, the encoder position information is retained even when the power is OFF. For those types, it is unnecessary to perform home-return operation every time the power is turned ON.

For Simple Absolute Type registers the home position in the cases of 1) to 3) (absolute reset) to retain.

- 1) At initial startup
- 2) When the absolute battery was replaced with the power to the controller is shut, and
- 3) Disconnection of encoder cable from controller

Battery-less Absolute Type registers the home position in the cases of 1) and 2) stated below.

- 1) At motor replacement
- 2) When absolute error generated

The absolute reset is performed by using a teaching tool such as PC software or PIO. Each of the absolute reset procedures is described below.

[1] Absolute Reset Procedure from Teaching Tool

- 1) Connect the controller with the actuator. [Refer to Chapters 1 and 2.]
- 2) For simple absolute type, connect the absolute battery (Enclosed battery if starting up for the first time, new battery if replacing) to the absolute battery connecting connector on the front panel of the controller. [Refer to Section 6.2.]
- 3) Connect the teaching tool and turn ON the power of the controller.
- 4) The absolute encoder error appears on the teaching tool. Perform alarm reset.
- 5) Perform home-return operation. Once the home return is complete, the point of origin is memorized at the same time the origin point is established.

In below explains the procedure using each teaching tool:

(1) For PC software

- 1** Select position data on the main screen and click the **Alarm** button.

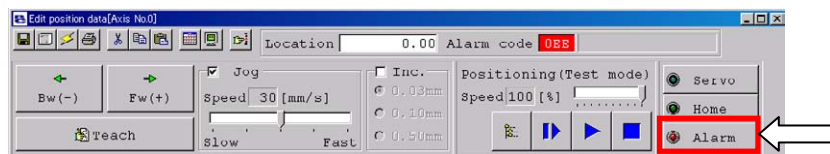

- 2** Turn the servo ON with **Servo** button, and press **Home** button.

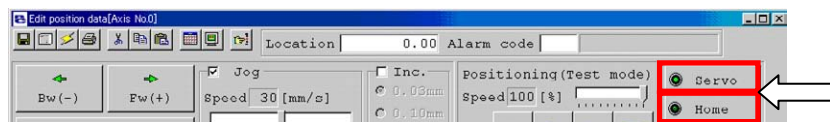

(2) For Teaching Pendant (TB-02/TB-03)

1 Press **Alarm reset**.

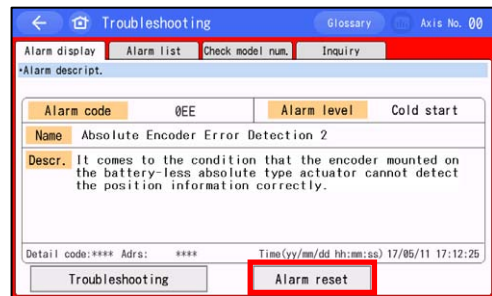

2 Press **Trial Operation** on the Menu 1 screen.

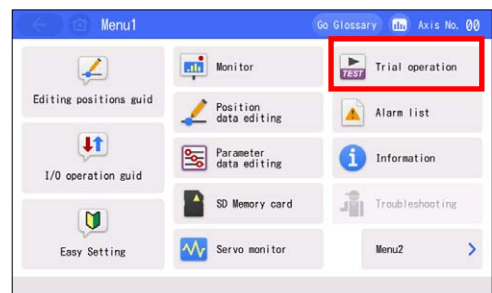

3 Press **Jog inching** on Test run screen.

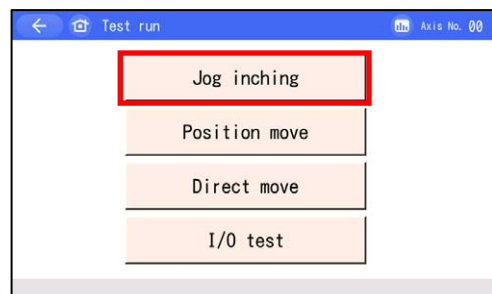

4 Touch **Servo** to turn the servo ON and touch **Homing** in Jog inching screen.



(3) For Teaching Pendant (TB-01)

1 Press **Reset Alm.**

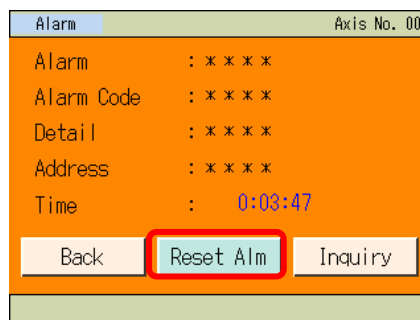

2 Press **Trial Operation** on the Menu 1 screen.

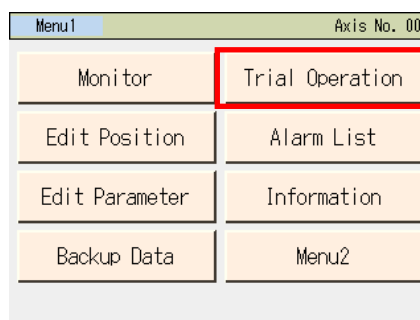

3 Press **Jog_Inching** on Trial Operation screen.

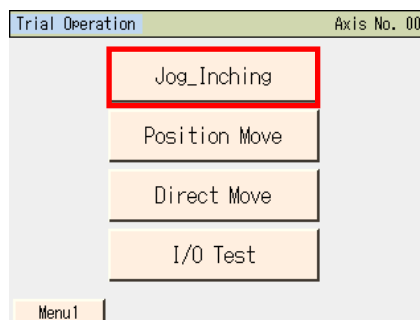

4 Touch **SV OFF** to turn the servo ON and touch **HOME** in Jog screen.

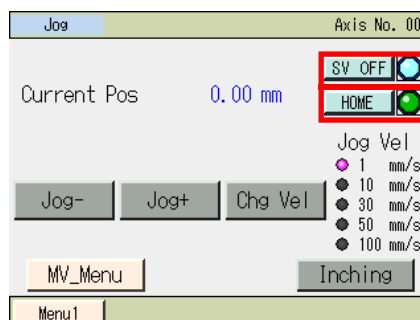

[2] Absolute Reset Using PIO

- 1) Turn the reset signal RES from OFF to ON. (Processed with ON edge.)
- 2) Check that the alarm signal *ALM is ON (controller's alarm^(Note 1) is cancelled).
(Note 1) If the cause of the alarm is not removed, an alarm will be present again (*ALM signal OFF). Check the condition including other alarm causes.
- 3) Turn ON the pause signal *STP.
- 4) Turn the servo-on signal SON ON.
- 5) Wait until the servo-on status SV turns ON.
- 6) Turn the home return signal HOME (ST0 signal in case of PIO pattern 5) ON (with ON edge). The home return operation is started.
- 7) When the homing completion signal HEND is turned ON (completion of home return), absolute reset is completed.

[Absolute Reset Process]

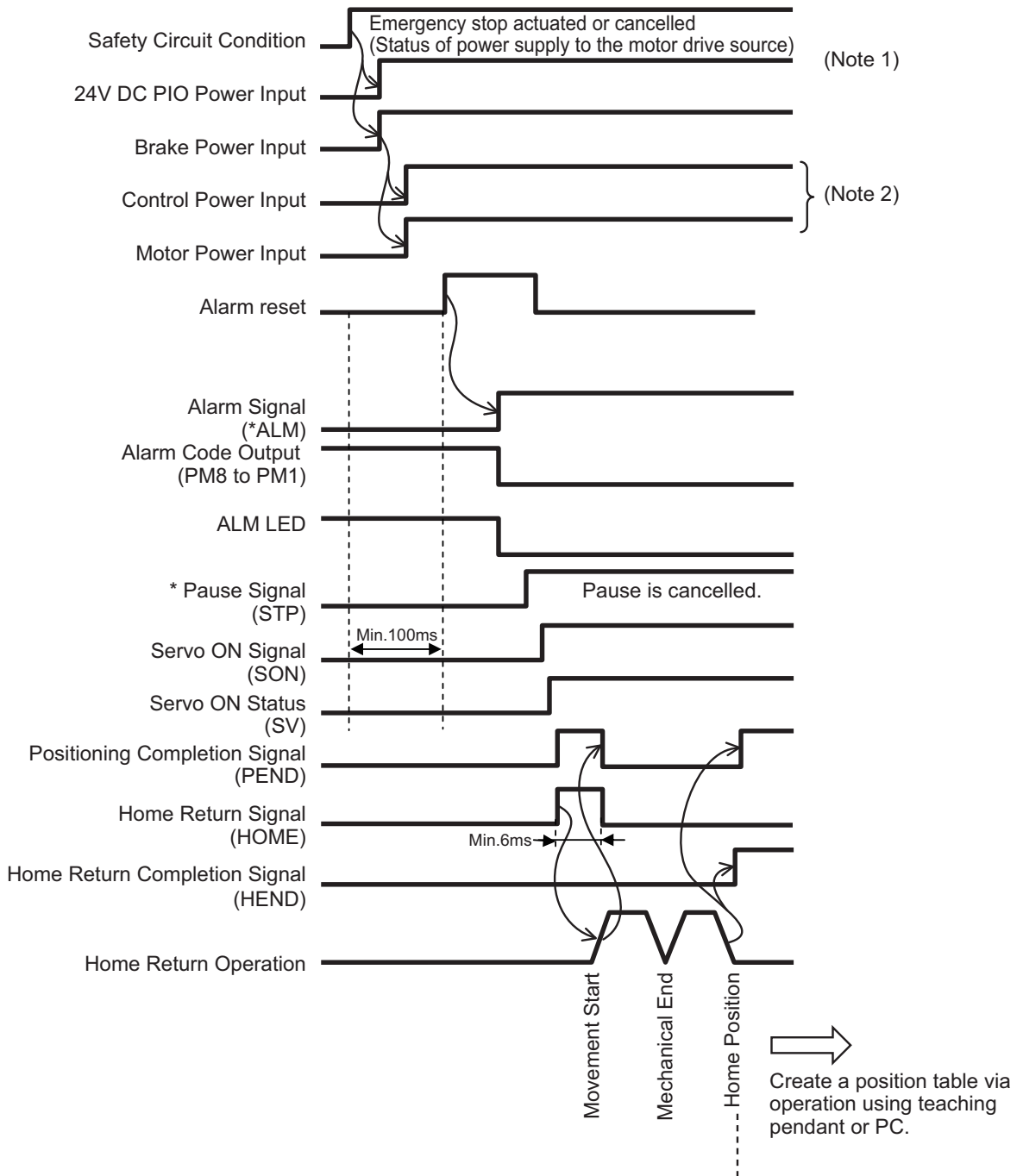

Note 1 Turn ON 24V power supply for PIO (and 24V power supply for brake if the actuator is equipped with a brake) prior to turn ON the control power supply or motor power supply.

Note 2 Have the control power supply and motor power supply in common, and have them turned ON that the same time.

6.2 Absolute Battery (for Simple Absolute Type)

[1] For the Type to Attach Battery to Controller Side

Absolute battery and fabric hook-and-loop faster are enclosed in the simple absolute type controllers.

The absolute battery is used to back up the absolute data.

Separate the faster and attach one on the side surface of the controller and the other on the absolute battery. Join the 2 pieces of the faster, one on the controller and the other on the battery, to affix the battery. Connect the battery to the absolute battery connector on the front panel of the controller.

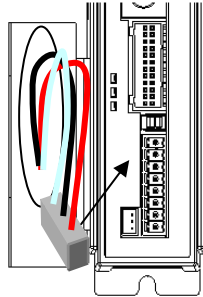

[2] When Using Absolute Battery Unit

Establish a connection between the absolute battery connector on the controller and the connector for absolute battery unit connection with the dedicated cable (CB-APSEP-AB005).

6.2.1 Absolute Encoder Backup Specifications

Item	Specifications
Battery model	AB-7
Battery voltage	3.6V
Current capacity	3300mAH
Reference for battery replacing timing ^(Note 1)	Approx. 3 years (It varies significantly by the effects of the usage condition)

(Note 1) Replace the battery regularly.

6.2.2 Absolute Battery Charge

Please have the battery charged for more than 72 hours before using for the first time or after replacing with a new one. The battery gets charged while the controller is supplied with 24V power.

It is possible to retain the encoder data for the duration shown below for each hour of battery charge.

Data holding time

Value for User Parameter No.155	0	1	2	3
Upper limit of encoder revolution at power-OFF [RPM]	100	200	400	800
Data holding time per hour of battery charge time ^(Note 1) (reference)	6.6H	5.0H	3.3H	1.6H
Holding time when fully charged ^(Note 1) (reference)	20 days	15 days	10 days	5 days

(Note 1) Followings are the reference values of time assuming the battery is new.

Leaving the controller power OFF for more than the data holding time will lead to a loss of the data. Have the battery charged as early as possible.

There is life to the battery and the duration for data holding will decrease. Replace the battery with a new one if the retaining time is remarkably dropped even with enough charging time.

(Example) From Monday to Friday ; charge for 8 hours per day, discharge for 16 hours, Saturday and Sunday ; use with discharge

1) If the upper limit setting for the number of encoder revolution is 800 [PRM];

Full charge amount : 24 [h] *5 [day] = 120 [h]

Total charge amount : 8 [h] *1.6 [h] *5 [day] = 64 [h]

Total discharge amount : 16 [h] *5 [day] + 48 [h] = 128 [h]

→ Assuming a start with full charge on Monday, it is necessary to fully charge the battery every 10 days.

2) If the upper limit setting for the number of encoder revolution is 400 [PRM];

Total charge amount : 8 [h] *3.3 [h] *5 [day] = 132 [h]

Total discharge amount : 16 [h] *5 [day] + 48 [h] = 128 [h]

→ It is not necessary to have a continuous full charge if starting on Monday.

4-hour charge is stored every week. The upper limit is the reference value for the retaining duration after fully charged.

6.2.3 Replacement of Absolute Battery

When replacing the battery, leave the power to the controller ON, remove the battery connector and replace with a new battery.

[1] For the Type to Attach Battery to Controller Side

[Removal]

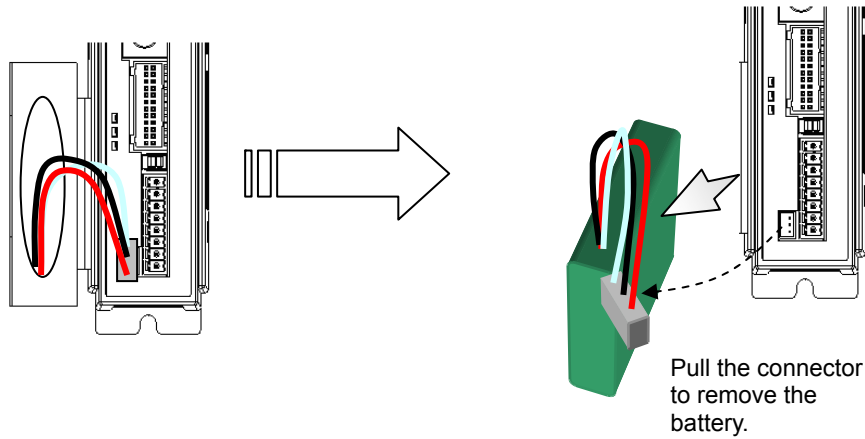

[Attachment]

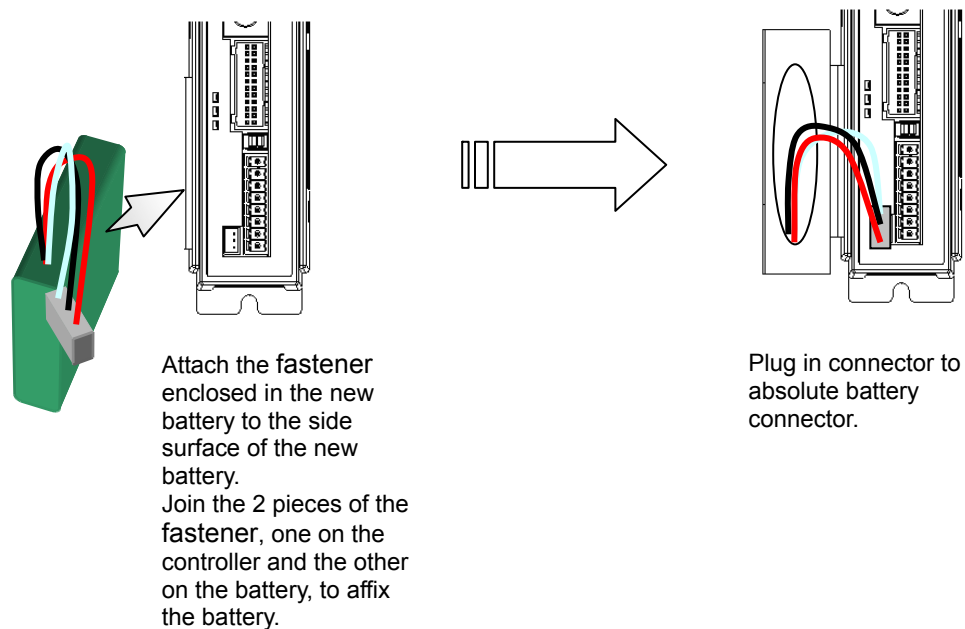

[2] When Using Absolute Battery Unit

- 1) Detach the absolute battery connector first, and then remove the absolute battery unit cover retaining screws (2 places) to detach the cover. At this time, pull out the battery cables from the opening on the cover.
- 2) Take out the battery.

Follow the reversed steps to put the battery back ON.

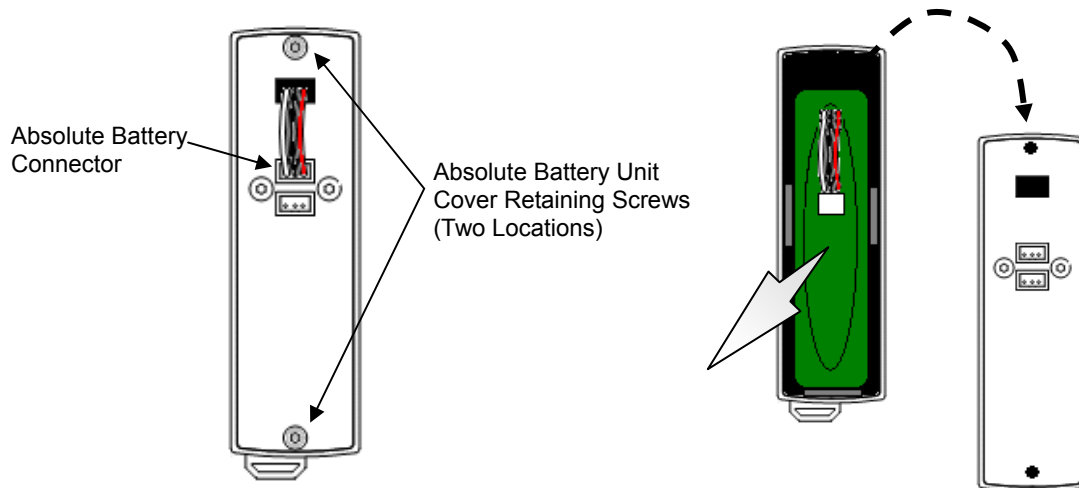

As the dust-proof type battery unit is not capable to take off the cover, it is necessary to replace the whole unit.

POWER CON **PCON-CB** ---

Chapter 7 Parameter

Parameters are the data to set up considering the system and application.

When a change is required to the parameters, make sure to back up the data before the change so the settings can be returned anytime.

With using PC software, it is able to store the backup to the PC. Teaching pendant is able to store the back up to the memory card.

Also, for the purpose of rapid recovery after the investigation of failure unit or replacing the controller, keep data backup or memo also after the parameter change.

The change to the parameters will be activated after they are edited, written to the flash FeRAM, then either software reset or reboot of the power. It will not be active only with writing on the teaching tool.



Warning: Parameter setting has great influences on operations of the controller. Incorrect parameter setting may not only cause malfunction or failure of the controller to occur but also people and assets to be exposed to risk. The controller is configured to be applicable to normal operation at shipment. Before providing certain change or setting for the controller to be fit to your system, understand the control methods of the controller sufficiently. Please contact us if you have anything unclear. Do not turn OFF the power to the controller during the parameter writing.

7.1 Parameter List

The categories in the table below indicate whether parameters should be set or not. There are five categories as follows:

A : Check the settings before use.

B : Use parameters of this category depending on their uses.

C : Use parameters of this category with the settings at shipments leaving unchanged as a rule. Normally they may not be set.

D : Parameters of the category are set at shipment in accordance with the specification of the actuator. Normally they may not be set.

E : Parameters of the category are exclusively used by us for convenience of production.

Changing their settings may not only cause the actuator to operate improperly but also to be damaged. So, never change the setting of the parameters.

Category do not appear on the teaching tool.

Also, the unused parameter numbers are not mentioned in the list.

No.	Category	Name	Unit ^(Note1)	Input Range	Default factory setting	for Positioner Mode	for Pulse Train Mode	Relevant sections
1	B	Zone Boundary 1+	mm (deg)	-9999.99 to 9999.99	Actual stroke on + side ^(Note2)	○	○	7.2 [1] 7.2 [82]
2	B	Zone Boundary 1-	mm (deg)	-9999.99 to 9999.99	Actual stroke on - side ^(Note2)	○	○	7.2 [1] 7.2 [82]
3	A	Soft limit+	mm (deg)	-9999.99 to 9999.99	Actual stroke on + side ^(Note2)	○	○	7.2 [2]
4	A	Soft limit-	mm (deg)	-9999.99 to 9999.99	Actual stroke on - side ^(Note2)	○	○	7.2 [2]
5	D	Home return direction	—	0: Reverse 1: Normal	In accordance with actuator ^(Note2)	○	○	7.2 [3]
6	C	Press & hold stop judgment period	ms	0 to 9999	In accordance with actuator ^(Note2)	○		7.2 [4]
7	C	Servo gain number	—	0 to 31	In accordance with actuator ^(Note2)	○	○	7.2 [5] 7.3
8	B	Default velocity	mm/s (deg/s)	1 to Actuator's max. speed	Rated actuator speed ^(Note2)	○		7.2 [6]
9	B	Default acceleration/deceleration	G	0.01 to actuator's max. acceleration/ deceleration	Rated actuator's acceleration/ deceleration ^(Note2)	○		7.2 [7]
10	B	Default positioning width	mm (deg)	0.01 to 999.99	In accordance with actuator ^(Note2)	○	○	7.2 [8]
12	B	Current-limiting value at standstill during positioning	%	1 to 70	35	○	○	7.2 [9]
13	C	Current-limiting value during home return	%	1 to 100	In accordance with actuator ^(Note2)	○	○	7.2 [10]
15	B	Pause input disable	—	0: Enabling 1: Disabling	0	○		7.2 [11]
16	B	SIO communication speed	bps	9600 to 230400	38400	○		7.2 [12]
17	B	Minimum delay time for slave transmitter activation	ms	0 to 255	5	○		7.2 [13]
18	E	Home position check sensor input polarity	—	0 to 2	In accordance with actuator ^(Note2)	○	○	7.2 [14]
21	B	Servo ON input disable	—	0: Enabling 1: Disabling	0	○	○	7.2 [15]
22	C	Home return offset level	mm (deg)	0.00 to 9999.99	In accordance with actuator ^(Note2)	○	○	7.2 [16]
23	B	Zone Boundary 2+	mm (deg)	-9999.99 to 9999.99	Actual stroke on + side ^(Note2)	○	○	7.2 [1] 7.2 [82]
24	B	Zone Boundary 2-	mm (deg)	-9999.99 to 9999.99	Actual stroke on - side ^(Note2)	○	○	7.2 [1] 7.2 [82]
25	A	PIO pattern selection	—	0 to 7	0 (Standard Type)	○	○	7.2 [18]
26	B	PIO jog velocity	mm/s (deg/s)	1 to Actuator's max. speed	100	○	○	7.2 [19]

Note 1 The unit (deg) is for rotary actuator and lever type gripper. It is displayed in mm in the teaching tools.

Note 2 The setting values vary in accordance with the specification of the actuator. At shipment, the parameters are set in accordance with the specification.

I/O Parameter List (Continued)

No.	Category	Name	Unit ^(Note1)	Input Range	Default factory setting	for Positioner Mode	for Pulse Train Mode	Relevant sections
27	B	Movement command type	–	0: Level 1: Edge	0	○		7.2 [20]
28	B	Default movement direction for excitation-phase signal detection	–	0: Reverse 1: Normal	In accordance with actuator ^(Note2)	○	○	7.2 [21]
29	B	Excitation-phase signal detection time	ms	1 to 999	In accordance with actuator ^(Note2)	○	○	7.2 [22]
30	B	Excitation Detection Type	–	0: Conventional method 1: New method 1 2: New method 2	In accordance with actuator ^(Note2)	○	○	7.2 [23]
31	C	Velocity loop proportional gain	–	1 to 99999999	In accordance with actuator ^(Note2)	○	○	7.2 [24] 7.3
32	C	Velocity loop integral gain	–	1 to 99999999	In accordance with actuator ^(Note2)	○	○	7.2 [25] 7.3
33	C	Torque filter time constant	–	0 to 2500	In accordance with actuator ^(Note2)	○	○	7.2 [26] 7.3
34	C	Press velocity	mm/s (deg/s)	1 to actuator's max. pressing speed	In accordance with actuator ^(Note2)	○		7.2 [27]
35	C	Safety velocity	mm/s (deg/s)	1 to 250 (The maximum velocity should be the upper limit for the actuators with the maximum velocity less than 250.)	100	○	○	7.2 [28]
36	B	Auto servo-motor OFF delay time 1	sec	0 to 9999	0	○		7.2 [29]
37	B	Auto servo-motor OFF delay time 2	sec	0 to 9999	0	○		7.2 [29]
38	B	Auto servo-motor OFF delay time 3	sec	0 to 9999	0	○		7.2 [29]
39	B	Position complete signal output method ^(Note3)	–	0: PEND 1: INP	0	○		7.2 [30]
40	C	Home-return input disable	–	0: Enabling 1: Disabling	0	○	○	7.2 [31]
41	C	Operating-mode input disable	–	0: Enabling 1: Disabling	0	○	○	7.2 [32]
42	C	Enable function	–	0: Enabling 1: Disabling	1	○	○	7.2 [33]
43	B	Home position check sensor input polarity	–	0 to 2	In accordance with actuator ^(Note2)	○	○	7.2 [34]
45	B	Silent interval magnification	times	0 to 10	0	○		7.2 [35]
46	B	Velocity override	%	0 to 100	100	○		7.2 [36]
47	B	PIO jog velocity 2	mm/s (deg/s)	1 to Actuator's max. speed	100	○		7.2 [37]
48	B	PIO inch distance	mm (deg)	0.01 to 1.00	1.0	○		7.2 [38]
49	B	PIO inch distance 2	mm (deg)	0.01 to 1.00	0.1	○		7.2 [38]
50	C	Load output judgment time period	ms	0 to 9999	255	○		7.2 [39]
51	B	Torque inspected range	–	0: Enabling 1: Disabling	0	○		7.2 [40]
52	B	Default acceleration/deceleration mode	–	0 to 2	0 (Trapezoid)	○	○	7.2 [41]
53	B	Default stop mode	–	0 to 7	0 (Not Applicable)	○		7.2 [42]
55	B	Position-command primary filter time constant	ms	0.0 to 100.0	0	○	○	3.3.5 [1] 7.2 [43]
56	B	S-motion rate	%	0 to 100	0	○		7.2 [44]
57	B	Torque limit	%	0 to 70	70		○	3.3.5 [2]
58	E	Clearing deviation during servo OFF or alarm stop	–	0: Disabling 1: Enabling	1		○	3.3.5 [3]
59	C	Error monitor during torque limiting	–	0: Disabling 1: Enabling	0		○	3.3.5 [4]

Note 1 The unit (deg) is for rotary actuator and lever type gripper. It is displayed in mm in the teaching tools.

Note 2 The setting values vary in accordance with the specification of the actuator. At shipment, the parameters are set in accordance with the specification.

Note 3 In the pulse-train mode, INP is automatically selected. (Cannot be selected)

I/O Parameter List (Continued)

No.	Category	Name	Unit ^(Note1)	Input Range	Default factory setting	for Positioner Mode	for Pulse Train Mode	Relevant sections
60	B	Deviation counter clear input	–	0: Enabling 1: Disabling	0		○	3.3.5 [5]
61	B	Torque limit command input	–	0: Enabling 1: Disabling	0		○	3.3.5 [6]
62	B	Pulse count direction	–	0: Forward motor rotation 1: Reverse motor rotation	In accordance with actuator ^(Note2)		○	3.3.5 [7]
63	B	Command pulse input mode (Pulse train mode)	–	0 to 2	1 (pulse-train and moving direction angle)		○	3.3.4 [2]
64	B	Command pulse input mode polarity	–	0: Positive Logic 1: Negative Logic	0		○	3.3.4 [2]
65	B	Electronic gear numerator	–	1 to 4096	200		○	3.3.4 [1]
66	B	Electronic gear denominator	–	1 to 4096	15		○	3.3.4 [1]
67	B	Compulsory stop input	–	0: Enabling 1: Disabling	0		○	3.3.5 [8]
71	B	Feed forward gain	–	0 to 100	0	○	○	7.2 [56]
77	D	Ball screw lead length	mm (deg)	0.01 to 999.99	In accordance with actuator ^(Note2)	○	○	7.2 [57]
78	D	Axis operation type	–	0: Linear Axis 1: Rotary Axis	In accordance with actuator ^(Note2)	○		7.2 [58]
79	B	Rotary axis mode selection	–	0: Normal Mode 1: Index Mode	In accordance with actuator ^(Note2)	○		7.2 [59]
80	B	Rotational axis shortcut selection	–	0: Disabling 1: Enabling	In accordance with actuator ^(Note2)	○		7.2 [60]
83	B	Absolute unit	–	0: Incremental 1: Absolute Type (Simple/Battery-less)	In accordance with specification at order accepted	○		7.2 [61]
84	A	Fieldbus operation mode ^(Note4)	–	0 to 4	Separate volume	○		7.2 [62] Separate volume
85	A	Fieldbus node address ^(Note4)	–	0 to 65535	Separate volume	○		7.2 [63] Separate volume
86	A	Fieldbus baud rate ^(Note4)	–	0 to 4	Separate volume	○		7.2 [64] Separate volume
87	E	Network type ^(Note4)	–	0 to 9	Separate volume	○		7.2 [65] Separate volume
88	D	Software limit margin	mm	0 to 9999.99	In accordance with actuator ^(Note2)	○	○	7.2 [66]
90	C	Fieldbus I/O format ^(Note4)	–	0 to 3	Separate volume	○		7.2 [67] Separate volume
91	C	Current limit value at stopping due to miss-pressing	–	0: Current limit value during movement 1: Current limit value during pressing	0	○		7.2 [68]
110	B	Stop method at servo OFF	–	0: Rapid stop 1: Deceleration to stop	0	○		7.2 [69]
111	B	Calendar function	–	0: Does not use the calendar timer 1: Use the calendar timer	1	○	○	7.2 [70]
112	B	Monitoring mode	–	0: Does not use 1: Monitor function 1 2: Monitor function 2 3: Monitor function 3	1	○	○	7.2 [71]
113	B	Monitoring period	ms	1 to 60000	1	○	○	7.2 [72]

Note 1 The unit (deg) is for rotary actuator and lever type gripper. It is displayed in mm in the teaching tools.

Note 2 The setting values vary in accordance with the specification of the actuator. At shipment, the parameters are set in accordance with the specification.

Note 4 These parameters are exclusively used for the field network type.

I/O Parameter List (Continued)

No.	Category	Name	Unit	Input Range	Default factory setting	for Positioner Mode	for Pulse Train Mode	Relevant sections
140	B	IP address	-	0.0.0.0 to 255.255.255.255	Separate volume	○	○	7.2 [73] Separate volume
141	B	Subnet mask	-	0.0.0.0 to 255.255.255.255	Separate volume	○	○	7.2 [74] Separate volume
142	B	Default gateway	-	0.0.0.0 to 255.255.255.255	Separate volume	○	○	7.2 [75] Separate volume
143	B	Overload level ratio	%	50 to 100	100	○		7.2 [76]
144	B	Gain scheduling upper limit multiplying ratio	%	0 to 1023	0	○		7.2 [77]
145	C	GS velocity loop proportional gain	-	1 to 99999999	In accordance with actuator (Note2)	○		7.2 [78]
146	C	GS velocity loop integral gain	-	1 to 99999999	In accordance with actuator (Note2)	○		7.2 [79]
147	B	Total movement count threshold	Times	0 to 999999999	0 (Disabling)	○		7.2 [80]
148	B	Total operated distance threshold	m	0 to 999999999	0 (Disabling)	○	○	7.2 [81]
149	B	Zone output changeover	-	0: Not to change 1: To change	0	○		7.2 [82]
151	B	Light malfunction alarm output select	-	0: Overload warning output 1: Message label alarm output	1	○	○	7.2 [83]
152	B	High output setting	-	0: Disabling 1: Enabling	In accordance with actuator (Note2)	○	○	7.2 [84]
153	B	BU velocity loop proportional gain	-	1 to 99999999	In accordance with actuator (Note2)	○		7.2 [85]
154	B	BU velocity loop integral gain	-	1 to 99999999	In accordance with actuator (Note2)	○		7.2 [86]
155	A	Absolute battery retention time	-	0: 20 days 1: 15 days 2: 10 days 3: 5 days	0	○		7.2 [87]
156	B	Torque check/Light malfunction output select	-	0: Torque check effective 1: Light malfunction effective	0	○	○	7.2 [88]
159	B	FB half direct mode speed unit (Note 4)	-	0: Units of 1mm/s 1: Units of 0.1mm/s	Separate volume	○		7.2 [90] Separate volume
165	B	Delay time after shutdown release	ms	0 to 100	0	○	○	7.2 [91]
166	B	Startup current limit extension feature	-	0: Disabling 1: Enabling	0 (Disabling)	○	○	7.2 [92]
167	B	Pulse train datum position	mm	-9999.99 to 9999.99	0	○	○	7.2 [93]
168	B	Collision detection feature	-	0 to 7	0	○	○	7.2 [94]
182	B	Automatic current reduction feature select	-	0: Disabling 1: Enabling	0	○		7.2 [95]
187	C	Command Output Complete Judgement Time in Non-Positioner Mode	ms	0 to 255	0		○	3.3.5 [9]
188	A	Network Number (Note4)	-	1 to 239	Separate volume	○	○	7.2 [97] Separate volume
192	C	Actuator recognition function	-	0: Disabling 1: Enabling	0	○	○	5.3.3 7.2 [98]

Note 2 The setting values vary in accordance with the specification of the actuator. At shipment, the parameters are set in accordance with the specification.

Note 4 These parameters are exclusively used for the field network type.

 **Caution:** Make sure to set to "Positioner Mode" (No. 25 PIO Pattern = 0 to 5) when performing an operation with using the serial communication. If it happens to be in the "pulse train mode" by mistake, the controller may operate erratically because it is operated according to the "pulse train mode" parameters.

7.2 Detail Explanation of Parameters

⚠ Caution: • If parameters are changed, provide software reset or reconnect the power to reflect the setting values.
 • The unit (deg) is for rotary actuator and lever type gripper. Pay attention that it is displayed in mm in the teaching tools.

[1] Zone Boundary 1+, Zone Boundary 1- (Parameter No.1, No.2)
 Zone Boundary 2+, Zone Boundary 2- (Parameter No.23, No.24)

No.	Name	Unit	Input Range	Default factory setting
1	Zone Boundary 1+	mm (deg)	-9999.99 to 9999.99	Actual stroke on + side
2	Zone Boundary 1-	mm (deg)	-9999.99 to 9999.99	Actual stroke on - side
23	Zone Boundary 2+	mm (deg)	-9999.99 to 9999.99	Actual stroke on + side
24	Zone Boundary 2-	mm (deg)	-9999.99 to 9999.99	Actual stroke on - side

These parameters are used set the zone in which zone signal (ZONE1 or ZONE2) turns ON in a mode other than PIO patterns 1 to 3.

The minimum setting unit is 0.01mm (deg).

If a specific value is set to both zone boundary + and zone boundary -, the zone signal is not output.

A setting sample is shown below.

[Example of when line axis]

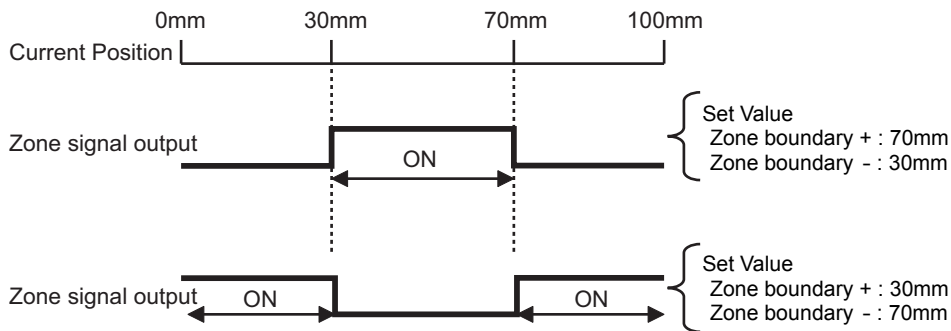

[Example of Rotary Actuator Index Mode]

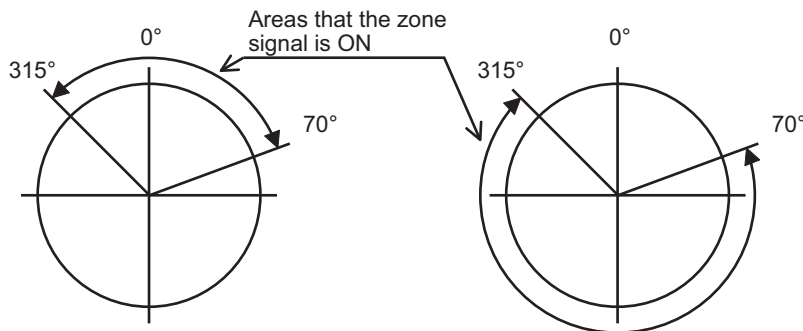

⚠ Caution: The signal cannot be output unless of the zone detection is set to a value greater than that of the minimum resolution (actuator lead length/encoder pulse value).

[2] Soft limit+, Soft limit- (Parameter No.3, No.4)

No.	Name	Unit	Input Range	Default factory setting
3	Soft limit +	mm (deg)	-9999.99 to 9999.99	Actual stroke on + side
4	Soft limit -	mm (deg)	-9999.99 to 9999.99	Actual stroke on - side

0.3mm (deg) is added to the outside of the effective actuator stroke for the setting at the delivery (since there would be an error at the end of effective stroke if set to 0). Change the setting if required for the cases such as when there is interference or to prevent a crash, or when using the actuator with slightly exceeding effective stroke in the operational range. An incorrect soft limit setting will cause the actuator to collide into the mechanical end, so exercise sufficient caution.

The minimum setting unit is 0.01mm.

(Note) To change a soft limit, set a value corresponding to 0.3mm outside of the effective stroke.

Example) Set the effective stroke to between 0mm and 80mm

Parameter No.3 (positive side) 80.3

Parameter No.4 (negative side) -0.3

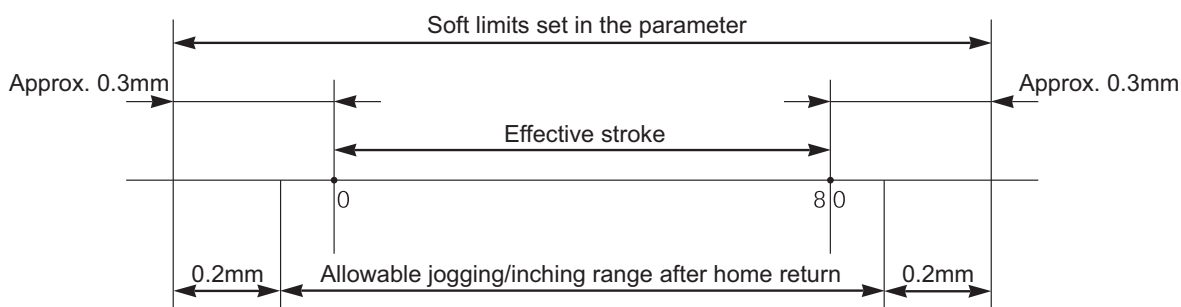

The operational range for jog and inching after the home return is 0.2mm less than the set value.

Alarm Code 0D9 "Soft Limit Over Error" will be generated when the set value exceeded the value (0 when shipped out) set in Parameter No.88 "Software Limit Margin". If the setting is not done in Parameter No.88, the value set in this parameter become the detection value for Alarm Code 0D9 "Soft Limit Over Error".

[3] Home return direction (Parameter No.5)

No.	Name	Unit	Input Range	Default factory setting
5	Home return direction	-	0: Reverse 1: Forward	In accordance with actuator

Unless there is a request of Home Reversed Type (option), the home-return direction is on the motor side for the line axis, counterclockwise side for the rotary axis and outer (open) side for the gripper. [Refer to the coordinate system of the actuator.]

If it becomes necessary to reverse the home direction after the actuator is installed on the machine, change the setting.

Caution: There are some models that the home-return direction cannot be changed or the home-return operation cannot be completed and generates an error if this setting is changed for structural reasons.

[4] Press & hold stop judgment period (Parameter No.6)

No.	Name	Unit	Input Range	Default factory setting
6	Press & hold stop judgment period	ms	0 to 9999	In accordance with actuator

Judging completion of pressing operation

(1) For Standard type (PIO pattern 0 to 3)

The operation monitors the torque (current limit value) in percent in "Pressing" of the position table and turns pressing complete signal PEND ON when the load current satisfies the condition shown below during pressing. PEND is turned ON at satisfaction of the condition if the work is not stopped.

(Accumulated time in which current reaches pressing value [%])

– (accumulated time in which current is less than pressing value [%])
 ≥ 255 ms (Parameter No.6)

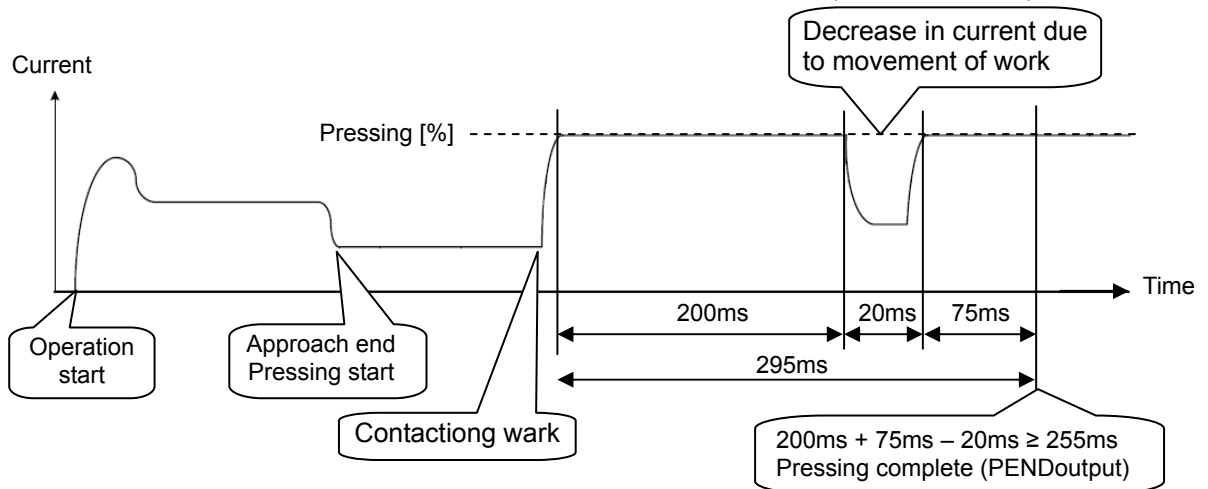

[5] Servo gain number (Parameter No.7)

No.	Name	Unit	Input Range	Default factory setting
7	Servo gain number	-	0 to 31	In accordance with actuator

The servo gain is also called position loop gain or position control system proportional gain. The parameter defines the response when a position control loop is used. Increasing the set value improves the tracking performance with respect to the position command. However, increasing the parameter value excessively increases the chances of overshooting. When the set value is too low, the follow-up ability to the position command is degraded and it takes longer time to complete the positioning.

For a system of low mechanical rigidity or low natural frequency (every object has its own natural frequency), setting a large servo gain number may generate mechanical resonance, which then cause not only vibrations and/or noises but also overload error to occur.

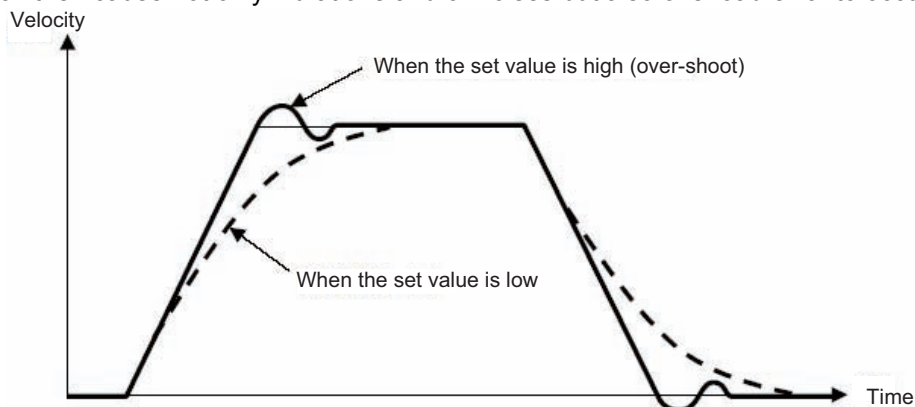

[6] Default velocity (Parameter No.8)

No.	Name	Unit	Input Range	Default factory setting
8	Default velocity	mm/s (deg/s)	1 to Actuator's max. velocity	Rated actuator speed

The factory setting is the rated velocity of the actuator.
When a target position is set in an unregistered position table, the setting in this parameter is automatically written in the applicable position number.
It is convenient to set the velocity often used.

[7] Default acceleration/deceleration (Parameter No.9)

No.	Name	Unit	Input Range	Default factory setting
9	Default acceleration/deceleration	G	0.01 to actuator's max. acceleration/ deceleration	Rated actuator's acceleration/ deceleration

The factory setting is the rated acceleration/deceleration of the actuator.
When a target position is set in an unregistered position table, the setting in this parameter is automatically written in the applicable position number.
It is convenient to set the acceleration/deceleration often used.

[8] Default positioning width (in-position) (Parameter No.10)

No.	Name	Unit	Input Range	Default factory setting
10	Default positioning width	mm (deg)	0.01 ^(Note 1) to 999.99	In accordance with actuator

When a target position is set in an unregistered position table, the setting in this parameter is automatically written in the applicable position number. When the remaining moving distance enters into this width, the positioning complete signal PEND/INP is output.
It is convenient to set the positioning width often used.

 **Caution:** Make sure to set a value of or higher than the minimum positioning band width for the initial positioning band width.

(For 800-Pulse Encoder)

$$\text{Minimum positioning width} = \text{Lead length} \div 800 (\text{Encoder pulse value}) \times 3$$

(For 8192-Pulse Encoder)

$$\text{Minimum positioning width} = \text{Lead length} \div 8192 (\text{Encoder pulse value})$$

Note 1 The minimum setting value should be the minimum positioning band width for RCP4 and RCP5 Series actuators.

[9] Current-limiting value at standstill during positioning (Parameter No.12)

No.	Name	Unit	Input Range	Default factory setting
12	Current-limiting value at standstill during positioning	%	1 to 70	In accordance with actuator

When the value is increased, the stop holding torque is increased.
Even though it is generally unnecessary to change this setting, setting the value larger is necessary in the case a large external force is applied during stop. Please contact IAI.

[10] Current-limiting value during home return (Parameter No.13)

No.	Name	Unit	Input Range	Default factory setting
13	Current-limiting value during home return	%	1 to 100	In accordance with actuator

The factory setting conforms to the standard specification of the actuator.

Increasing this setting will increase the home return torque.

Normally this parameter need not be changed. If the home return should be completed before the correct position depending on the affixing method, load condition or other factors when the actuator is used in a vertical application, the setting value must be increased. Please contact IAI.

[11] Pause input disable (Parameter No.15)

No.	Name	Unit	Input Range	Default factory setting
15	Pause input disable	-	0 : Enabling 1 : Disabling	0

This parameter defines whether the pause input signal is disabled or enabled.

If pause from PIO is not required, setting the parameter to "1" allows the actuator to be operated without wiring of the pause signal input.

Set Value	Description
0	Enable (Use the input signal)
1	Disable (Does not use the input signal)

[12] SIO communication speed (Parameter No.16)

No.	Name	Unit	Input Range	Default factory setting
16	SIO communication speed	bps	9600 to 230400	38400

Set the SIO baud rate for the startup.

Set an appropriate value in accordance with the communication speed of the host.

One of 9600, 14400, 19200, 28800, 38400, 76800, 115200 and 230400 bps can be selected as the communication speed.

 **Caution:** After the PC software is connected, the baud rate setting is changed to that of the PC software. To make effective the value set in the parameter, cycle controller power.

[13] Minimum delay time for slave transmitter activation (Parameter No.17)

No.	Name	Unit	Input Range	Default factory setting
17	Minimum delay time for slave transmitter activation	ms	0 to 255	5

In this setting, set the time from receiving the command (received data) during the SIO communication till the response (sent data) is returned to the host side.

[14] Home position check sensor input polarity (Parameter No.18)

No.	Name	Unit	Input Range	Default factory setting
18	Home position check sensor input polarity	-	0 to 2	In accordance with actuator

The home sensor is an option.

Set Value	Description
0	Standard specification (sensor not used)
1	Input is a contact
2	Input is b contact

[15] Servo ON input disable (Parameter No.21)

No.	Name	Unit	Input Range	Default factory setting
21	Servo ON input disable	-	0 : Enabling 1 : Disabling	0

This parameter defines whether the servo ON input signal is disabled or enabled. When the servo ON input signal is disabled, the servo is turned ON as soon as the controller power is turned ON.

Set this parameter to "1" if servo ON/OFF is not provided by PIO signals.

Set Value	Description
0	Enable (Use the input signal)
1	Disable (Does not use the input signal)

[16] Home return offset level (Parameter No.22)

No.	Name	Unit	Input Range	Default factory setting
22	Home return offset level	mm (deg)	0.00 to 9999.99	In accordance with actuator

In this setting can set the distance from the mechanical end to the home position.

An adjustment is available for the following cases.

- 1) Want to match the actuator home position and the mechanical origin of the system.
- 2) Want to set a new home after reversing the factory-set home direction.
- 3) Want to eliminate a slight deviation from the previous home position generated after replacing the actuator.

[Adjustment Process]

- 1) Homing execution
- 2) Offset check
- 3) Parameter setting change
- 4) After the setting, repeat home return several times to confirm that the actuator always returns to the same home position.

 **Caution :** If the home return offset has been changed, the soft limit parameters must also be adjusted accordingly.
Do not set a smaller value than the initial setting value for Home Return Offset. Normal excitation detection cannot be performed, and there may be a risk of generating the excitation detection error or causing abnormal noise. In case there is a necessity of setting a value less than the initial setting, contact IAI.

[17] Zone Boundary 2+, Zone Boundary 2- (Parameter No.23, No.24)
 [Refer to 7.2 [1].]

[18] PIO pattern selection (Parameter No.25)

No.	Name	Unit	Input Range	Default factory setting
25	PIO pattern selection	-	0 to 7	0 (Standard Type) 6 (Pulse train control type)

Select the PIO operation pattern in Parameter No.25.

For the details of PIO patterns, refer to 3.2 Operation in Positioner Mode and 3.3 Operation in Pulse Train Control Mode.

Pattern type	Value set in Parameter No.25	Mode	Feature of PIO pattern
PIO pattern 0	0 (factory setting)	Positioning mode (Standard type)	<ul style="list-style-type: none"> • Number of positioning points: 64 • Position command: Binary code • Zone signal output: 1 point^(Note) • Position zone signal output: 1 point^(Note)
PIO pattern 1	1	Teaching mode (Teaching type)	<ul style="list-style-type: none"> • Number of positioning points: 64 • Position command: Binary code • Position zone signal output: 1 point^(Note) • Jog operation enabled by PIO signal • Writing current position data to position table enabled by PIO signal
PIO pattern 2	2	256-point mode (256-point type)	<ul style="list-style-type: none"> • Number of positioning points: 256 • Position command: Binary code • Position zone signal output: 1 point^(Note)
PIO pattern 3	3	512-point mode (512-point type)	<ul style="list-style-type: none"> • Number of positioning points: 512 • Position command: Binary code • Zone signal output: None
PIO pattern 4	4	Solenoid valve mode 1 (7-point type)	<ul style="list-style-type: none"> • Number of positioning points: 7 • Position command: Individual No. signal ON • Zone signal output: 1 point^(Note) • Position zone signal output: 1 point^(Note)
PIO pattern 5	5	Solenoid valve mode 2 (3-point type)	<ul style="list-style-type: none"> • Number of positioning points: 3 • Position command: Individual No. signal ON • Signal equivalent to LS (limit switch) enabled • Zone signal output: 1 point^(Note) • Position zone signal output: 1 point^(Note)
PIO pattern 6	6 (at delivery in pulse train control)	Pulse train control mode for incremental	<ul style="list-style-type: none"> • Differential pulse input (MAX.200Kpps) • Home return function • Zone signal output: 2 point • No feedback pulse output
PIO pattern 7	7	Pulse train control mode for absolute	<ul style="list-style-type: none"> • Setting the datum point (1 places) • Differential pulse input (MAX.200Kpps) • Home return function • Zone signal output: 2 point • No feedback pulse output

(Note) Position zone signal can be switched over to zone signal. [Refer to Parameter No.149 zone output changeover.]

[19] PIO jog velocity (Parameter No.26)

No.	Name	Unit	Input Range	Default factory setting
26	PIO jog velocity	mm/s (deg/s)	1 to Actuator's max. speed ^(note1)	100

This is the jog operation velocity setting with PIO signal (jog input command) when PIO pattern = 1 (Teaching Mode) is selected.

Set an appropriate value in Parameter No.26 in accordance with the purpose of use.

Note 1 The maximum speed is limited to 250mm/s.

[20] Movement command type (Parameter No.27)

No.	Name	Unit	Input Range	Default factory setting
27	Movement command type	-	0 : Level 1 : Edge	0

Set the input methods for the start signal (ST0 to ST6, or ST0 to ST2 if PIO Pattern = 5) when PIO Pattern 4 = Solenoid Valve Mode 1 (7-point type) and PIO Pattern 5 = Solenoid Valve Mode 2 (3-point type) .

Set Value	Input method	Description
0	Level	The actuator starts moving when the input signal turns ON. When the signal turns OFF during movement, the actuator will decelerate to a stop and complete its operation.
1	Edge	The actuator starts moving when the rising edge of the input signal is detected. The actuator will not stop when the signal turns OFF during the movement, until the target position is reached.

[Level System]

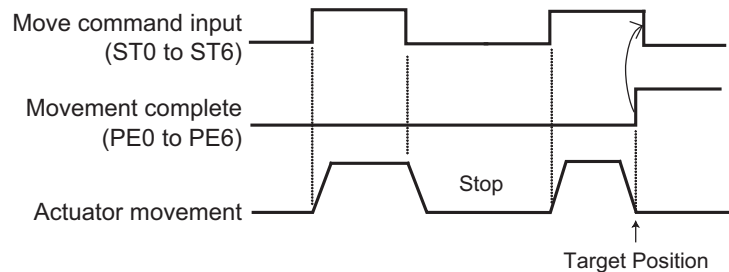

[Edge System]

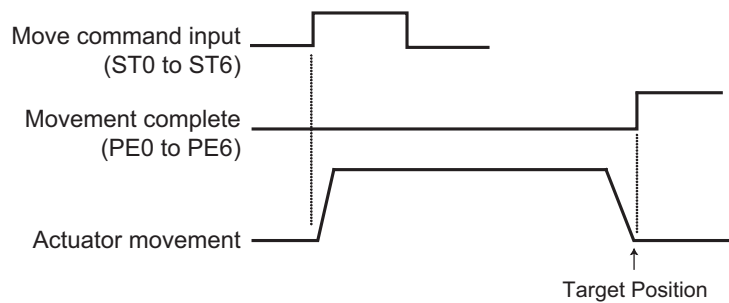

[21] Default movement direction for excitation-phase signal detection (Parameter No.28)

No.	Name	Unit	Input Range	Default factory setting
28	Default movement direction for excitation-phase signal detection	—	0 : Reversed direction 1 : Forward direction	In accordance with actuator

Excitation detection ^(Note) starts when the servo is turned ON for the first time after the power is supplied. Define the detection direction at this time.

Even though it is generally unnecessary to change this setting, set this to the direction which the motor is easy to move when the actuator interferes with the mechanical end or peripheral object at the time the power is supplied.

If the direction not interfering is the same direction as the home return direction, set the same values as set to Parameter No.5 Home Return Direction. If the direction is opposite, set the other values from Parameter No.5. (If No.5 is 0, set 1. If No.5 is 1, set 0.)

(Note) For Simple Absolute Type, the excitation detection is performed at the end of home return operation.

[22] Excitation-phase signal detection time (Parameter No.29)

No.	Name	Unit	Input Range	Default factory setting
29	Excitation-phase signal detection time	ms	1 to 999	In accordance with actuator

Excitation detection ^(Note) starts when the servo is turned ON for the first time after the power is supplied. Define the detection direction at this time.

Even though it is generally unnecessary to change this setting, changing the setting of this parameter may be effective when excitation error is generated or abnormal operation is confirmed.

Please contact us in the case a change is necessary to this parameter.

(Note) For Simple Absolute Type, the excitation detection is performed at the end of home return operation.

[23] Excitation detection type (Parameter No.30)

No.	Name	Unit	Input Range	Default factory setting
30	Excitation detection type	—	0 : Conventional method 1 : New method 1 (For vertical mount installation) 2 : New method 2 (For horizontal mount installation)	In accordance with actuator

Excitation detection ^(Note) starts when the servo is turned ON for the first time after the power is supplied. In the new method, this operation was made smoother, thus quieter than ever (if compared with our existing products).

In the case the new method 2 (horizontal mount installation) is set and the actuator is mounted vertically, the slider or the rod may drop at the excitation operation. Follow the instructed orientation to install. If the slide or rod drops with the mentioned way of installation, set with the current setting.

(Note) For Simple Absolute Type, the excitation detection is performed at the end of home return operation.

[24] Velocity loop proportional gain (Parameter No.31)

No.	Name	Unit	Input Range	Default factory setting
31	Velocity loop proportional gain	-	1 to 99999999	In accordance with actuator

This parameter determines the response of the speed control loop. When the set value is increased, the follow-up ability to the velocity command becomes better (the servo-motor rigidity is enhanced). The higher the load inertia becomes, the larger the value should be set. However, excessively increasing the setting will cause overshooting or oscillation, which may induce vibrations in the mechanical system.

[Reference Item] 7.2 [89] Selecting the Use of velocity loop proportional gain and velocity loop integrated gain.

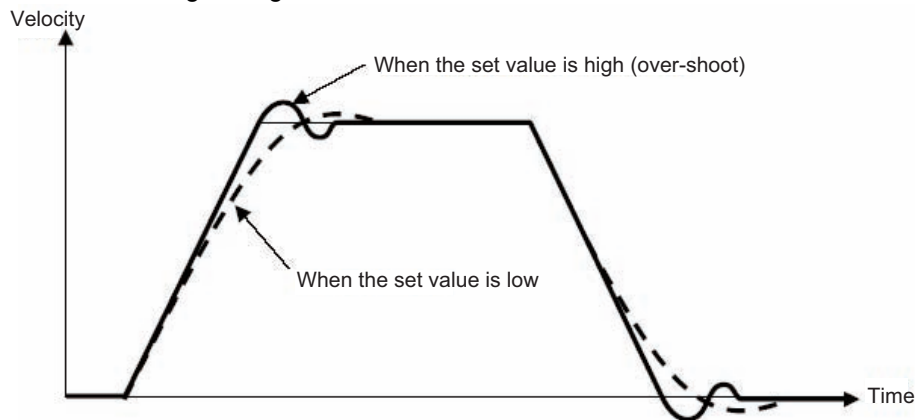

[25] Velocity loop integral gain (Parameter No.32)

No.	Name	Unit	Input Range	Default factory setting
32	Velocity loop integral gain	-	1 to 99999999	In accordance with actuator

Any machine produces friction. This parameter is intended to cope with deviation generated by external causes including friction. Increasing the setting value improves the reactive force against load change. That is, the servo rigidity increases. However, increasing the parameter value excessively may make the gain too high, which then causes the machine system to be vibrated due to overshoot or shaking.

Tune it to obtain the optimum setting by watching the velocity response.

[Reference Item] 7.2 [89] Selecting the Use of velocity loop proportional gain and velocity loop integrated gain.

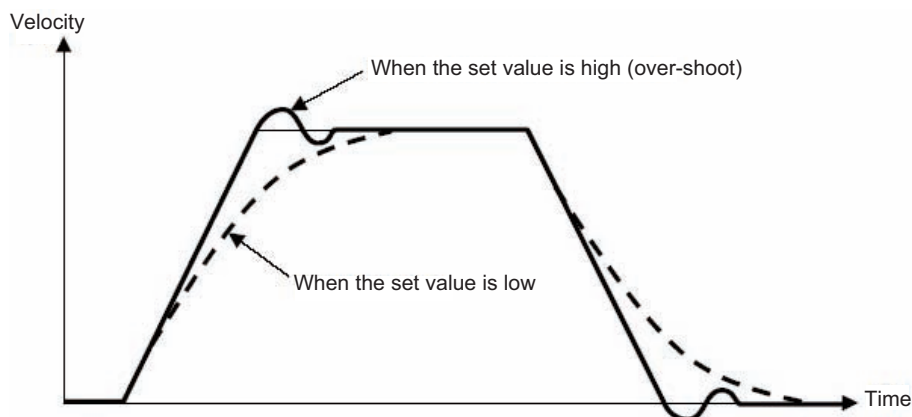

[26] Torque filter time constant (Parameter No.33)

No.	Name	Unit	Input Range	Default factory setting
33	Torque filter time constant	-	0 to 2500	In accordance with actuator

This parameter decides the filter time constant for the torque command. When vibration and/or noises occur due to mechanical resonance during operation, this parameter may be able to suppress the mechanical resonance. This function is effective for torsion resonance of ball screws (several hundreds Hz).

[27] Press velocity (Parameter No.34)

No.	Name	Unit	Input Range	Default factory setting
34	Press velocity	mm/s (deg/s)	1 to actuator's max. pressing speed	In accordance with actuator

This is the parameter to set the velocity in pressing operation. The setting is done considering the actuator type when the product is delivered. [Refer to 9.6 List of Specifications of Connectable Actuators]
 If a change to the setting is required, make sure to have the setting below the maximum pressing velocity of the actuator. Setting it fast may disrupt to obtain the specified pressing force. Also when setting at a low velocity, take 5mm/s as the minimum.

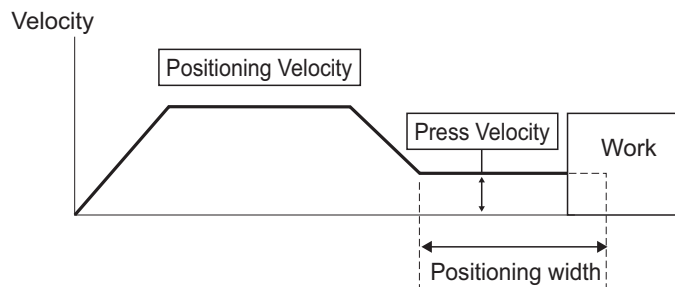

⚠ Caution: If the velocity of the positioning of the position table is set below this parameter, the pressing speed will become the same as the positioning speed.

[28] Safety velocity (Parameter No.35)

No.	Name	Unit	Input Range	Default factory setting
35	Safety velocity	mm/s (deg/s)	1 to 250 (The maximum velocity should be the upper limit for the actuators with the maximum velocity less than 250.)	100

This is the parameter to set the maximum speed of manual operation while the safety velocity selected in the teaching tool. Do not have the setting more than necessary.

[29] Auto servo motor OFF delay time 1, 2, 3 (Parameter No.36, No.37, No.38)

No.	Name	Unit	Input Range	Default factory setting
36	Auto servo motor OFF delay time 1	sec	0 to 9999	0
37	Auto servo motor OFF delay time 2	sec	0 to 9999	0
38	Auto servo motor OFF delay time 3	sec	0 to 9999	0

Set the duration before the servo turns OFF after positioning process is complete when the power saving function is used.

[Refer to 5.2 Power-saving Function.]

[30] Position complete signal output method (Parameter No.39)

No.	Name	Unit	Input Range	Default factory setting
39	Position complete signal output method	-	0: PEND 1: INP	0

This is the parameter to select the type of the positioning complete signals to be used. It is available except for when PIO Pattern = 5 (Solenoid Valve Type 2 [3-point type]) is selected.

There are 2 types of positioning complete signals and the output condition would differ depending on whether the servo is ON after the positioning is complete or the servo is OFF.

Setting	Signal Type	During Servo ON (positioning complete)	During Servo OFF
0	PEND	It will not turn OFF even if the current position is out of the range of the positioning width.	Turns OFF in any case
1	INP	Turns ON when the current position is in the positioning width, and OFF when out of it.	Turns OFF in any case
Pulse train control mode ^(Note1)	INP	AUTO/ MANU	Turns OFF in any case

Complete position No. outputs PM1 to PM** and current position No. outputs PE0 to PE6 are issued in the similar way.

Note 1 In Pulse Train Mode, the signal becomes INP compulsorily when the setting is AUTO, and turns OFF during the servo-off condition.

[31] Home-return input disable (Parameter No.40)

No.	Name	Unit	Input Range	Default factory setting
40	Home-return input disable	-	0 : Enabling 1 : Disabling	0

This parameter defines whether the home return input signal is disabled or enabled. Normally this parameter need not be changed.

Set Value	Description
0	Enable (Use the input signal)
1	Disable (Does not use the input signal)

[32] Operating-mode input disable (Parameter No.41)

No.	Name	Unit	Input Range	Default factory setting
41	Operating-mode input disable	-	0 : Enabling 1 : Disabling	0

This parameter defines whether the operation mode input signal is disabled or enabled. Normally this parameter need not be changed.

Set Value	Description
0	Enable (Use the input signal)
1	Disable (Does not use the input signal)

[33] Enable function (Parameter No.42)

No.	Name	Unit	Input Range	Default factory setting
42	Enable function	-	0 : Enabling 1 : Disabling	1

Set valid/invalid the deadman switch function if the teaching pendant is equipped with a deadman switch.

Set Value	Description
0	Enable (Use the input signal)
1	Disable (Does not use the input signal)

[34] Home position check sensor input polarit (Parameter No.43)

No.	Name	Unit	Input Range	Default factory setting
43	Home position check sensor input polarity	-	0: Sensor not used 1: a contact 2: b contact	0

Set the input signal polarity of the home position check sensor (option).

Since the home position check sensor is installed just below the mechanical end, if the actuator reverses without reaching the mechanical end because of a reason such as interference, an alarm will be generated because it will be identified as off the position and causes home position sensor non-detected error.

It is generally unnecessary to change the setting.

Set Value	Description
0	Home position check sensor not used
1	Sensor polarity: Contact a
2	Sensor polarity: Contact b

[35] Silent interval magnification (Parameter No.45)

No.	Name	Unit	Input Range	Default factory setting
45	Silent interval magnification	times	0 to 10	0

Use this parameter to set the silent interval (no communication) time by the time taken for communication of 3.5 characters or longer before command data transmission when the controller is operated via serial communication (RTU).

This parameter need not be changed when a teaching tool such as PC software is used. If "0" is set, no multiplier is applied.

[36] Velocity override (Parameter No.46)

No.	Name	Unit	Input Range	Default factory setting
46	Velocity override	%	0 to 100	100

When move commands are issued from the PLC, the moving speed set in the “Velocity” field of the position table can be overridden by the value set by this parameter.

Actual movement velocity = [Velocity set in the position table] × [setting value in Parameter No.46]

Example) Value in the “Velocity” field of the position table: 500mm/s
Setting in Parameter No.46 20%

In this case, the actual movement speed becomes 100mm/s.

The minimum setting unit is 1% and the input range is 1 to 100%.

(Note) This parameter is ignored for move commands from a teaching tool such as PC software.

[37] PIO jog velocity 2 (Parameter No.47)

No.	Name	Unit	Input Range	Default factory setting
47	PIO Jog velocity 2	mm/s (deg/s)	1 to Actuator's max. speed ^(Note 1)	100

This is the setting of JOG operation velocity when 1 is set in the JOG velocity / inching distance switchover signal JVEL for field network type.

Set the appropriate value considering how the system is to be used.

Note 1 The maximum speed is limited to 250mm/s.

[38] PIO inch distance, PIO inch distance 2 (Parameter No.48, No.49)

No.	Name	Unit	Input Range	Default factory setting
48	PIO inch distance	mm	0.01 to 1.00 ^(Note 1)	1.0
49	PIO inch distance 2	mm	0.01 to 1.00 ^(Note 1)	0.1

When the selected PIO pattern is “1” (Teaching Mode), Parameter No.48 defines the inching distance to be applied when inching input commands are received from the PLC. Parameter No.49 defines the inching distance when 1 is set in the JOG speed / inching distance switchover signal JVEL for field network type.

Note 1 The maximum allowable value is 1 mm.

[39] Load output judgment time period (Parameter No.50)

No.	Name	Unit	Input Range	Default factory setting
50	Load output judgment time period	ms	0 to 9999	255

It is to set the time period to judge the load output judgment status (LOAD) or torque level status (TRQS).

LOAD/TRQS Signals can be switched over in Parameter No. 51.

[Reference Item] 3.2.4 [4], 3.2.5 [3] Command Torque Level Detection at Pressing
5.1 Collision Detection Feature

[40] Torque inspected range (Parameter No.51)

No.	Name	Unit	Input Range	Default factory setting
51	Torque inspected range	-	0 : Enabling 1 : Disabling	0

Load output judgment status (LOAD) and torque level status (TRQS) should be switched over. It should be LOAD output when the parameter is set to 0 (initial setting) and TRQS output when 1. [Reference Item] 3.2.4 [4], 3.2.5 [3] Command Torque Level Detection at Pressing
5.1 Collision Detection Feature

[41] Default acceleration/deceleration mode (Parameter No.52)

No.	Name	Unit	Input Range	Default factory setting
52	Default acceleration/deceleration mode	-	0 to 2	0 (Trapezoid pattern)

When a target position is written to an unregistered position table, this value is automatically set as the "Acceleration/deceleration mode" of the applicable position number.

Set Value	Description
0	Trapezoid
1	S-motion
2	Primary delay filter

[42] Default stop mode (Parameter No.53)

No.	Name	Unit	Input Range	Default factory setting
53	Default stop mode	-	0 to 7	0 (Does not use)

This parameter defines the power-saving function. [Refer to 5.2 Power-saving Function.]

[43] Position-command primary filter time constant (Parameter No.55)

No.	Name	Unit	Input Range	Default factory setting
55	Position-command primary filter time constant	ms	0.0 to 100.0	0

Use this in the case to set the value in "Acceleration/Deceleration" box in the position table to 2 "1-step delay filter", or in the case that there is no acceleration/deceleration function the host controller in Pulse Train Control Mode.

The primary delay filter is disabled if "0" is set.

The greater the setting value is, the longer the delay is and the slower the acceleration/deceleration is. The impact at the acceleration and deceleration will be eased, but the takt time will become longer.

Refer to 3.3.5 [1] Position command primary filter time constant for the details of Pulse Train Control Mode.

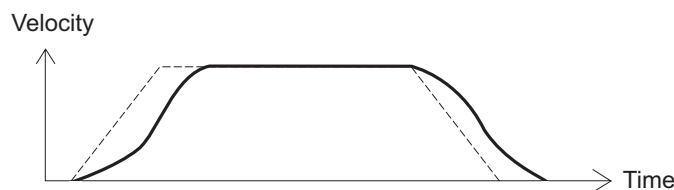

[44] S-motion rate (Parameter No.56)

No.	Name	Unit	Input Range	Default factory setting
56	S-motion rate	%	0 to 100	0

This parameter is used when the value in the “Acceleration/deceleration mode” field of the position table is set to “1 [S-motion]”. This enables to ease the impact at acceleration and deceleration without making the takt time longer.

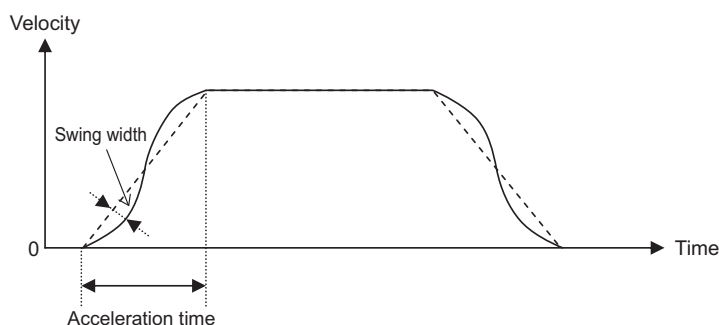

The S-motion is a sine curve that has the acceleration time as 1 cycle. The level of its swing width can be set by this parameter.

Setting of Parameter No.56 [%]	Level of swing width
0 [Set in delivery]	No S-motion (Dotted line shown in the image below)
100	Sine curve swing width $\times 1$ (Double-dot dashed line shown in the image below)
50	Sine curve swing width $\times 0.5$ (Dashed line shown in the image below)
10	Sine curve swing width $\times 0.1$ (Solid line shown in the image below)

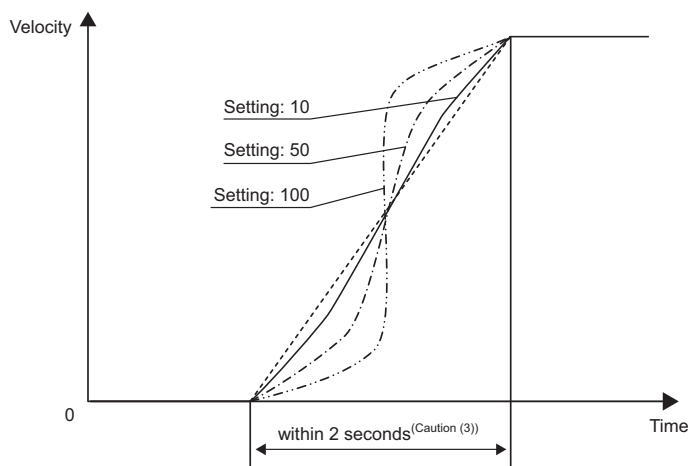

⚠ Caution: (1) If the S-motion is specified in acceleration/deceleration mode, executing position command or direct value command while the actuator is moving causes an actuator to move along the trapezoid pattern. To change a speed during operation, be sure to specify such a position command while the actuator is in pause state.

(2) In the index mode of rotary actuator, the S-motion control is disabled. If S-motion acceleration/deceleration is specified, the trapezoid pattern is used in acceleration/deceleration mode.

(3) If acceleration time or deceleration time exceeds 2 seconds, do not specify S-motion control. The actuator will fail to operate normally.

(4) Do not perform temporary stop during acceleration or deceleration. The speed change (acceleration) may cause the dangerous situation.

- [45] Torque limit (Parameter No.57)
This parameter is exclusively used for the pulse-train control mode.
[Refer to 3.3.5 Parameter Settings Required for Advanced Operations.]
- [46] Deviation clear at servo OFF & alarm stop (Parameter No.58)
This parameter is exclusively used for the pulse-train control mode.
[Refer to 3.3.5 Parameter Settings Required for Advanced Operations.]
- [47] Deviation error monitor during torque limiting (Parameter No.59)
This parameter is exclusively used for the pulse-train control mode.
[Refer to 3.3.5 Parameter Settings Required for Advanced Operations.]
- [48] Deviation counter clear input (Parameter No.60)
This parameter is exclusively used for the pulse-train control mode.
[Refer to 3.3.5 Parameter Settings Required for Advanced Operations.]
- [49] Torque limit command input (Parameter No.61)
This parameter is exclusively used for the pulse-train control mode.
[Refer to 3.3.5 Parameter Settings Required for Advanced Operations.]
- [50] Pulse count direction (Parameter No.62)
This parameter is exclusively used for the pulse-train control mode.
[Refer to 3.3.5 Parameter Settings Required for Advanced Operations.]
- [51] Command pulse input mode (Parameter No.63)
This parameter is exclusively used for the pulse-train control mode.
[Refer to 3.3.4 Settings of Basic Parameters Required for Operation.]
- [52] Command pulse input mode polarity (Parameter No.64)
This parameter is exclusively used for the pulse-train control mode.
[Refer to 3.3.4 Settings of Basic Parameters Required for Operation.]
- [53] Electronic gear numerator (Parameter No.65)
This parameter is exclusively used for the pulse-train control mode.
[Refer to 3.3.4 Settings of Basic Parameters Required for Operation.]
- [54] Electronic gear denominator (Parameter No.66)
This parameter is exclusively used for the pulse-train control mode.
[Refer to 3.3.4 Settings of Basic Parameters Required for Operation.]
- [55] Compulsory stop input (Parameter No.67)
This parameter is exclusively used for the pulse-train control mode.
[Refer to 3.3.5 Parameter Settings Required for Advanced Operations.]

[56] Position feed forward gain (Parameter No.71)

No.	Name	Unit	Input Range	Default factory setting
71	Feed forward gain	-	0 to 100	0

This parameter defines the level of feed forward gain to be applied to position control. Setting this parameter allows the servo gain to be increased and the response of the position control loop to be improved. This is the parameter to improve the takt time and traceability even more after fine-tuning the settings for “Servo Gain Number (Parameter No.7)”, “Velocity Loop Proportional Gain (Parameter No.31)”, etc. This can result in shorter positioning time. The gain adjustment of position, speed and current loop in feedback control can directly change the response of the servo control system. Thus, improper adjustment may cause the control system to be unstable and further vibrations and/or noises to occur. On the other hand, since this parameter only changes the speed command value and does not relate with the servo loop, it neither makes the control system unstable nor generate continuous vibrations and/or noises. However, excessive setting may generate vibrations and/or noises until the machine can follow command values in every operation.

In the trapezoidal pattern, adding the value resulting from multiplying the speed command by the feed forward gain to the speed command can reduce the delay of speed follow-up and the position deviation.

The feedback control providing control in accordance with the result causes control delay to occur. This conducts the supportive control independent from the control delay.

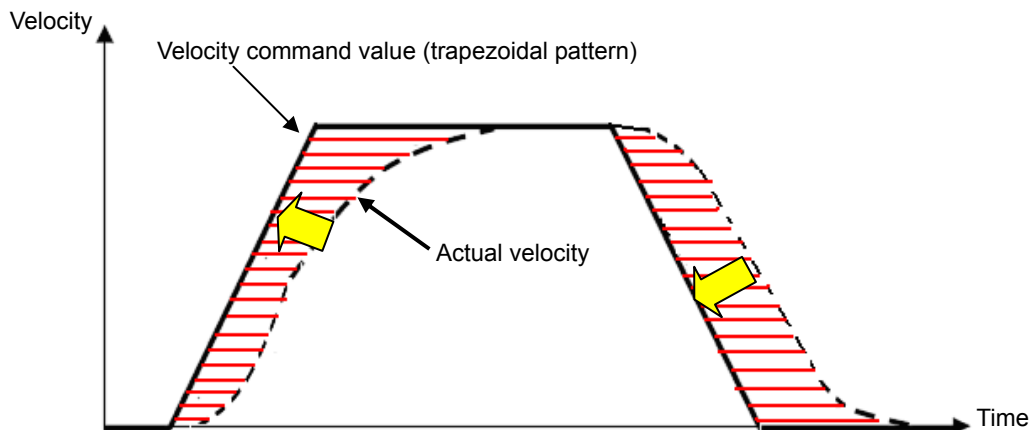

[57] Ball screw lead length (Parameter No.77)

No.	Name	Unit	Input Range	Default factory setting
77	Ball screw lead length	mm	0.01 to 999.99	In accordance with actuator

This parameter set the ball screw lead length.
The factory setting is the value in accordance with the actuator characteristics.

 **Caution:** If the setting is changed, not only the normal operation with indicated speed, acceleration or amount to move is disabled, but also it may cause a generation of alarm, or malfunction of the unit.

[58] Axis operation type (Parameter No.78)

No.	Name	Unit	Input Range	Default factory setting
78	Axis operation type	-	0: Linear Axis 1: Rotary Axis	In accordance with actuator

This parameter defines the type of the actuator used.

Connected Actuator	Set Value	Reference
Linear Axis	0	Actuator other than rotational axis
Rotary Axis	1	Rotary Axis (RCP2-RTB/RTBL/RTC/RTCL)

 **Caution:** Do not change the setting of this parameter. Failure to follow this may cause an alarm or fault to occur.

[59] Rotary axis mode selection (Parameter No.79)

No.	Name	Unit	Input Range	Default factory setting
79	Rotary axis mode selection	-	0: Normal Mode 1: Index Mode	In accordance with actuator

This parameter defines the mode of the rotational axis.
When the axis operation type (Parameter No.78) is set to “Rotary Axis” and the index mode is selected, the current value indication is fixed to “0 to 359.99”. When the index mode is selected, the shortcut control is enabled.

Set Value	Description
0	Normal Mode
1	Index Mode

 **Caution:** When it is set to “Index Mode”, the push & hold operation is not available. Even when data is entered in the “Push & Hold” data box in the Position Data, it becomes invalid and normal operation is performed. The positioning width becomes the parameter’s default value for the positioning width.

[60] Rotational axis shortcut selection (Parameter No.80)

No.	Name	Unit	Input Range	Default factory setting
80	Rotational axis shortcut selection	–	0: Disabling 1: Enabling	In accordance with actuator

Select whether valid/invalid the shortcut when positioning is performed except for when having the relative position movement in the multiple rotation type rotary actuator. The shortcut means that the actuator is rotated to the next position in the rotational direction of the smaller travel distance.

Set Value	Description
0	Disable
1	Enable

Refer to [Shortcut control of rotary actuator of multi-rotation specification] in 3.2.4 Position Number Input Operation.

[61] Absolute unit (Parameter No.83)

No.	Name	Unit	Input Range	Default factory setting
83	Absolute unit	–	0: Incremental 1: Simple Absolute Type or Battery-less Absolute Type	In accordance with specification at order accepted

Set to 1 if simple absolute type or battery-less absolute type and 0 if others.
Reference : Set to 0 when using the battery-less absolute in incremental.

[62] Fieldbus operation mode (Parameter No.84)

This parameter is exclusively used for the controller of field network specification.
[Check the applicable instruction manual number in Chapter 4 Field Network, and refer to each instruction manual.]

[63] Fieldbus node address (Parameter No.85)

This parameter is exclusively used for the controller of field network specification.
[Check the applicable instruction manual number in Chapter 4 Field Network, and refer to each instruction manual.]

[64] Fieldbus baud rate (Parameter No.86)

This parameter is exclusively used for the controller of field network specification.
[Check the applicable instruction manual number in Chapter 4 Field Network, and refer to each instruction manual.]

[65] Network type (Parameter No.87)

This parameter is exclusively used for the controller of field network specification.
[Check the applicable instruction manual number in Chapter 4 Field Network, and refer to each instruction manual.]

[66] Software limit margin (Parameter No.88)

No.	Name	Unit	Input Range	Default factory setting
88	Software limit margin	mm (deg)	0 to 9999.99	In accordance with actuator

This is the parameter to set the position of over error detection against the software limit errors set in Parameters No. 3 and No. 4.
It is not necessary to change the setting in normal use.

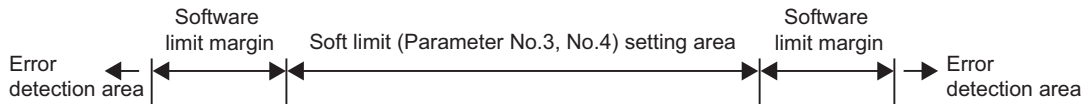

[67] Fieldbus I/O format (Parameter No.90)

This parameter is exclusively used for the controller of field network specification.
[Check the applicable instruction manual number in Chapter 4 Field Network, and refer to each instruction manual.]

[68] Current limit value at stopping due to miss-pressing (Parameter No.91)

No.	Name	Unit	Input Range	Default factory setting
91	Current limit value at stopping due to miss-pressing	-	0: Current limiting value at stop 1: Current limit value during pressing	0

This parameter defines the restricted current value at stopping due to miss-pressing.
This restricted current value locks the servo till the next moving command.

Parameter No.91	Description
0	Current limitation value while in operation stop (setting value in the current limiting value at positioning stop (Parameter No.12))
1	Press-motion current-limiting value

[69] Stop method at servo OFF (Parameter No.110)

No.	Name	Unit	Input Range	Default factory setting
110	Stop method at servo OFF	-	0: Rapid stop 1: Deceleration to stop	0

Select the stop mode for when the servo is turned OFF while in operation.
If it is set 0 (initial setting), the velocity setting is set to 0% and make a sudden stop.
If it is set 1, the actuator decelerates with position data in execution and stops.

[70] Calendar function (Parameter No.111)

No.	Name	Unit	Input Range	Default factory setting
111	Calendar function	–	0: Unused 1: Use	1

This parameter defines whether the calendar function (RTC) is used or not.

Set the current time with using a teaching tool when the calendar function is used.

[Refer to the instruction manual of the teaching tool for the details.]

In use of RTC, the alarm occurrence time in the alarm list is the time at which an alarm has occurred.

If RTC is not in use, the alarm generated time in the alarm list shows the time passed since 0sec that is the time the power is supplied to the controller.

The time data retainable duration with no power supply to the controller is approximately 10 days.

Set Value	Description
0	Unused
1	Use

[71] Monitoring mode (Parameter No.112)

No.	Name	Unit	Input Range	Default factory setting
112	Monitoring mode	–	0: Does not use 1: Monitor function 1 2: Monitor function 2 3: Monitor function 3	1

The controller can be connected with PC software to monitor the servo.

This parameter allows you to select a monitoring mode function (servo monitor).

Check the Instruction Manual of the RC PC software for details.

Set Value	Description
0	Unused
1	Sets the 4CH record mode.
2	Sets the 8CH record mode.
3	Sets the 2CH record mode.

[72] Monitoring period (Parameter No.113)

No.	Name	Unit	Input Range	Default factory setting
113	Monitoring period	ms	1 to 60000	1

This is the parameter to set up the frequency of time to obtain data (Sampling Frequency) when the monitoring mode is selected.

By setting the value in this parameter bigger, the frequency of data obtaining can be made longer.

It is set to 1ms in the initial setting. Up to 60s can be set.

Record mode	1ms frequency setting	100ms frequency setting
2CH	Max. Obtainable Time 8.19sec	Max. Obtainable Time 819sec
4CH	Max. Obtainable Time 4.095sec	Max. Obtainable Time 409.5sec
8CH	Max. Obtainable Time 2.047sec	Max. Obtainable Time 204.7sec

[73] IP address (Parameter No.140)

No.	Name	Unit	Input Range	Default factory setting
140	IP address	mm	0.0.0.0 to 255.255.255.255	192.168.0.1

It is the parameter dedicated for Field Network (EtherNet/IP).
[Refer to Ether Net/IP Instruction Manual (ME0278) provided separately.]

[74] Subnet mask (Parameter No.141)

No.	Name	Unit	Input Range	Default factory setting
141	Subnet mask	-	0.0.0.0 to 255.255.255.255	255.255.255.0

It is the parameter dedicated for Field Network (EtherNet/IP).
[Refer to Ether Net/IP Instruction Manual (ME0278) provided separately.]

[75] Default gateway (Parameter No.142)

No.	Name	Unit	Input Range	Default factory setting
142	Default gateway	-	0.0.0.0 to 255.255.255.255	0.0.0.0

It is the parameter dedicated for Field Network (EtherNet/IP).
[Refer to Ether Net/IP Instruction Manual (ME0278) provided separately.]

[76] Overload level ratio (Parameter No.143)

No.	Name	Unit	Input Range	Default factory setting
143	Overload level ratio	%	50 to 100	100

With the estimated risen temperature to generate overload alarm set as 100%, the overload warning (message level) alarm is output when the motor temperature has exceeded the ratio set in this parameter. Judgment will not be executed if set to 100.

[Applied: prevention function]

By setting this parameter, warning output notifies you before the equipment stops by error in case that the motor temperature rises due to load condition change caused by dry-up of grease or wear-out of components. Warning output (ALML Signal) can be conducted with PIO.

When it is required to use the overload warning, change the setting in Parameter No. 151 "Light Malfunction Alarm Output Select" to "0". [Refer to 7.2 [83]]

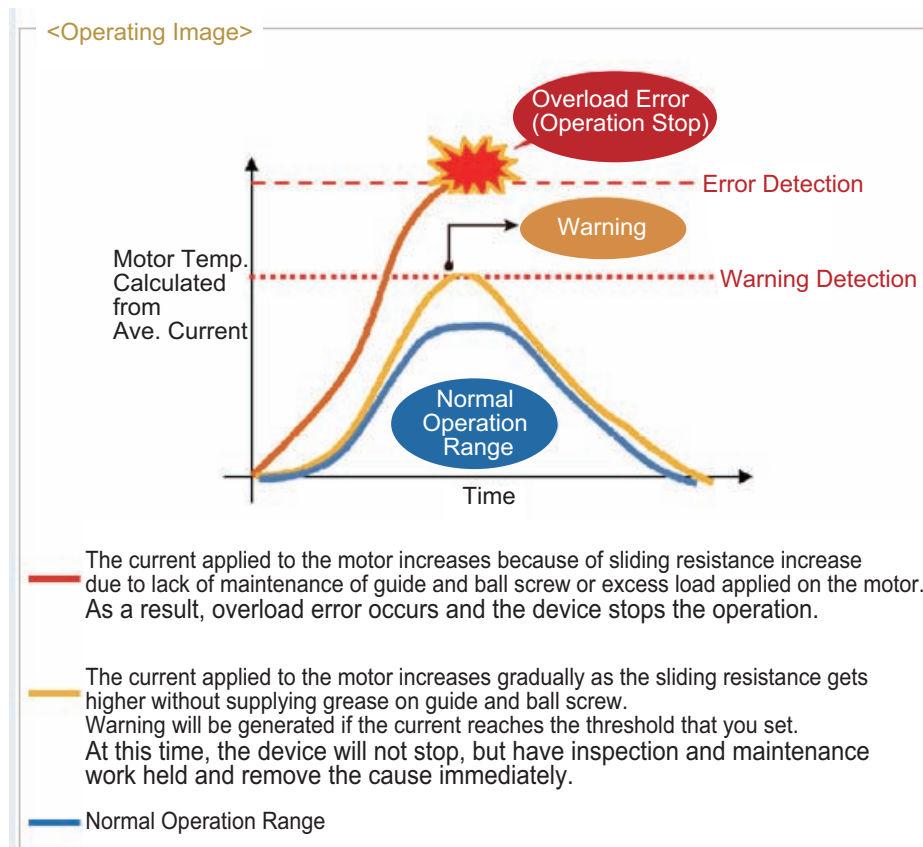

[77] Gain scheduling upper limit multiplying ratio (Parameter No.144)

No.	Name	Unit	Input Range	Default factory setting
144	Gain scheduling upper limit multiplying ratio	%	0 to 1023	0 (Disabling)

Gain scheduling is the function to change the gain in accordance with the operation speed. This parameter shows the multiplying rate of the upper limit of the changeable gain. With the set multiplying rate, the values for GS Velocity Loop Proportional Gain (Parameter No.145) and GS Velocity Loop Integrated Gain (Parameter No.146) are changed.

Set Value	Description
100 or less	Gain scheduling disabled
101 to 1023	Gain scheduling enabled (Recommended value 300)

[78] GS velocity loop proportional gain (Parameter No.145)

No.	Name	Unit	Input Range	Default factory setting
145	GS velocity loop proportional gain	-	1 to 99999999	In accordance with actuator

When the gain scheduling upper multiplying rate (Parameter No.144) is set to 101 or more, this parameter setting becomes effective for Velocity Loop Proportional Gain.

[Refer to the 7.2 [24] Velocity loop proportional gain for the details]

[Reference Item] 7.2 [89] Selecting the Use of velocity loop proportional gain and velocity loop integrated gain.

[79] GS velocity loop integral gain (Parameter No.146)

No.	Name	Unit	Input Range	Default factory setting
146	GS velocity loop integral gain	-	1 to 99999999	In accordance with actuator

When the gain scheduling upper multiplying rate (Parameter No.144) is set to 101 or more, this parameter setting becomes effective for Velocity Loop Integrated Gain.

[Refer to the 7.2 [25] Velocity loop integral gain for the details]

[Reference Item] 7.2 [89] Selecting the Use of velocity loop proportional gain and velocity loop integrated gain.

[80] Total movement count threshold (Parameter No.147)

No.	Name	Unit	Input Range	Default factory setting
147	Total movement count threshold	Times	0 to 999999999	0(Disabling)

A light error alarm is generated when the total movement count exceeds the value set to this parameter.

The judgment would not be made if the value is set to 0.

[81] Total operated distance threshold (Parameter No.148)

No.	Name	Unit	Input Range	Default factory setting
148	Total operated distance threshold	m	0 to 999999999	0(Disabling)

A light error alarm is generated when the total operation distance exceeds the value set to this parameter.

The judgment would not be made if the value is set to 0.

[82] Zone output changeover (Parameter No.149)

No.	Name	Unit	Input Range	Default factory setting
149	Zone output changeover	–	0: Not to change 1: To change	0

When there is PZONE signal to the current PIO pattern or the Field Network Operation Mode and no ZONE1 or ZONE2 signal, it is available to change the PZONE signal to either ZONE1 or ZONE2 signal.

⚠ Caution:

- ZONE1 signal is assigned prior to ZONE2 signal.
- It would not function in the pulse train mode.
- In the case there is no PZONE signal in PIO patterns, or both ZONE1 and ZONE2 signals exist, the setting would be invalid.

[83] Light Malfunction Alarm Output Select (Parameter No.151)

No.	Name	Unit	Input Range	Default factory setting
151	Select of light failure alarm output	–	0: Overload warning output 1: Message level alarm output	1

Select the output condition of *ALML Signal ^(Note 1).

When 0 is selected, *ALML Signal should be output in overload warning.

[Refer to the 7.2 [76] Overload level ratio for the details]

When 1 (initial setting) is selected, *ALML Signal should be output when an alarm in message level is generated.

Note1 In PIO Patterns 0 or from 2 to 4, Parameter No. 156 should be changed to 1, and LOAD/TRQS Signals should be switched to *ALML Signal.

[84] High output setting (Parameter No.152)

No.	Name	Unit	Input Range	Default factory setting
152	High output setting	–	0: Disable 1: Enable	In accordance with actuator

Set whether use the high output function. It is necessary to equip with the actuator applicable for the high output ^(Note1).

(Note 1) High-output applicable actuator: RCP4, RCP5, RCP6 Series

[85] BU velocity loop proportional gain (Parameter No.153)

No.	Name	Unit	Input Range	Default factory setting
153	BU velocity loop proportional gain	–	1 to 99999999	In accordance with actuator

When the high-thrust setting (Parameter No.152) is set effective, this parameter setting becomes effective for Velocity Loop Proportional Gain.

[Refer to the 7.2 [24] Velocity loop proportional gain for the details]

[Reference Item] 7.2 [89] Selecting the Use of velocity loop proportional gain and velocity loop integrated gain.

[86] BU velocity loop integral gain (Parameter No.154)

No.	Name	Unit	Input Range	Default factory setting
154	BU velocity loop integral gain	–	1 to 99999999	In accordance with actuator

When the high-thrust setting (Parameter No.152) is set effective, this parameter setting becomes effective for Velocity Loop Integrated Gain.

[Refer to the 7.2 [25] Velocity loop integral gain for the details]

[Reference Item] 7.2 [89] Selecting the Use of velocity loop proportional gain and velocity loop integrated gain.

[87] Absolute battery retention time (Parameter No.155)

No.	Name	Unit	Input Range	Default factory setting
155	Absolute battery retention time	–	0: 20 days 1: 15 days 2: 10 days 3: 5 days	0

For simple absolute type, set how long the encoder position information is to be retained after the power to the controller is turned OFF. The setting can be selected from 4 phases and as the motor rotation speed gets slower, the time to retain the position information gets longer. In the case that there is a possibility that the slide or the rod of the actuator that transports the work may be moved by an external force, follow the table below and calculate ^(Note 1) the number of rotation from the moved speed and set this parameter to the value faster than this value. If the motor rotation setting value exceeds the set value, the position information will be lost.

Setting	Motor rotation speed (rpm)	Position information retaining time (reference)
0 (Initial setting)	100	20 days
1	200	15 days
2	400	10 days
3	800	5 days

(Note 1) Motor rotation [rpm] = Moved speed [mm/s] / Lead length [mm] × 60

[88] Torque check/Light malfunction output select (Parameter No.156)

No.	Name	Unit	Input Range	Default factory setting
156	Torque check/Light malfunction output select	–	0: Load output judgment status or torque level status output 1: Light malfunction output	0

Select 1, and the load output judgment status (LOAD) or torque level status (TRQS) output can be changed to the light malfunction output (*ALML).

[89] Selecting the Use of velocity loop proportional gain and velocity loop integrated gain. Even though Velocity Loop Proportional Gain can be set to Parameter No.31, 145 and 153, and Velocity Loop Integrated Gain to Parameter No.32, 146 and 154, the values to be effective during an operation is just one of them. The following table shows which parameter number becomes effective in each condition.

		Effective Parameter Number	
		High Output Setting (Parameter No.152)	
		1 (Enable)	0 (Disable)
Gain Scheduling (Parameter No.144)	101 to (Enable)	Parameter No.145, 146	Parameter No.145, 146
	to 100 (Disable)	Parameter No.153, 154	Parameter No.31, 32

[90] FB half direct mode speed unit (Parameter No.159)

No.	Name	Unit	Input Range	Default factory setting
159	FB half direct mode speed unit	-	0: Units of 1mm/s 1: Units of 0.1mm/s	0

These parameters are exclusively used for the field network type.
[Check the applicable instruction manual number in Chapter 4 Field Network, and refer to each instruction manual.]

[91] Delay Time after Shutdown Release (Parameter No.165)

No.	Name	Unit	Input Range	Default factory setting
165	Delay time after shutdown release	ms	0 to 100	0

It is used in purpose to scatter the in-rush current when the power is supplied to multiple controllers from one power source.
It is used to set the delay time from the driving power supply (24V supplied to MPI) to shutdown cancellation.
It is available to scatter the peak load by having the time setting separately on each controller.

Example of use) When drive cutoff is constructed externally

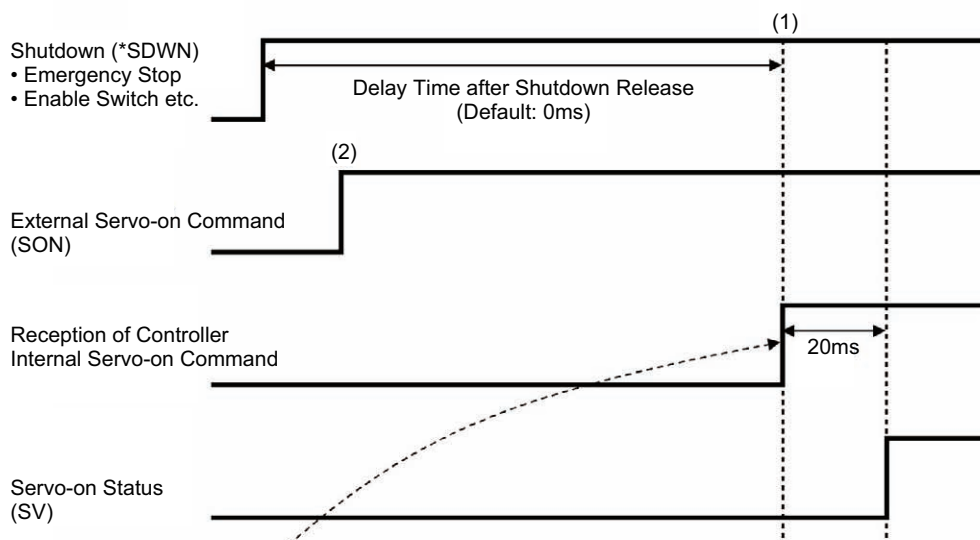

If the on-edge (2) of external servo-on command came after the point of passing "Delay Time after Shutdown Release" (1), the condition becomes reception of controller internal servo-on command at the point of (2).

[92] Startup Current Limit Extension Feature (Parameter No.166)

No.	Name	Unit	Input Range	Default factory setting
166	Startup current limit extension feature	-	0: Disable 1: Enable	0 (Disable)

Change the setting when this feature is necessary in the models stated below.

Applicable Models: RCP2-GRS/GRSS/GRST/GRM/GR3□S/GRLS

When the load is high at the start of movement to the target point, by having high current flowed for a certain period of time, the actuator operates with large force. It is expected to work well on an actuator with high static friction of load such as a condition of getting sticky.

 **Warning** : Do not attempt to set this parameter valid unless necessary. Make sure to confirm the followings when it is to be changed.

- As it generates high force in case also of load other than static friction, it may cause injury, damage on a workpiece or influence to the actuator life.
- As current higher than usual flows, it may require higher current amperage.

Also, note that this feature would not activate at the start of movement for following situations even if this parameter is set valid.

- 1) Home return
- 2) Operation resumed by cancelling pause
- 3) When movement command is issued during operation
- 4) Movement backward or forward by the actuator pushed due to such as deformation of a workpiece in a condition after pressing operation is finished and there is no next movement command

[93] Pulse train datum position (Parameter No.167)

No.	Name	Unit	Input Range	Default factory setting
167	Pulse train datum position	mm	-9999.99 to 9999.99	0

When the pulse train control mode (PIO Pattern 7) is selected, operation is made with the position set in this parameter as the datum position.

It is used when conducting the pulse train control in the absolute type controller.

[94] Collision Detection Feature (Parameter No.168)

No.	Name	Unit	Input Range	Default factory setting
168	Collision detection feature	-	0 to 7	0

It is a feature to generate a collision detection alarm and stop the operation (turn the servo OFF) when the actuator is crashed.

Detection is conducted in the range set that the position zone is set. [Refer to the 5.1 Collision Detection Feature]

Setting value	Operation status	Alarm level
0	Detection not to be conducted	-
1	Detection is conducted in position zone setting range.	Operation release level
3 (Note 1)	Detection is conducted in position zone setting range, but is not conducted in the following conditions. In this setting, it can avoid a mistake to detect the current during acceleration. <ul style="list-style-type: none"> • The first movement after releasing from a pause • Movement from a stop in the position zone range 	
5	Detection is conducted in position zone setting range.	Message level
7 (Note 1)	Detection is conducted in position zone setting range, but is not conducted in the following conditions. <ul style="list-style-type: none"> • The first movement after releasing from a pause • Movement from a stop in the position zone range 	

Note 1 In this setting, it can avoid a mistake to detect the current during acceleration.

[95] Automatic Current Reduction Feature (Parameter No.182)

No.	Name	Unit	Input Range	Default factory setting
182	Automatic Current Reduction Feature	-	0: Disable 1: Enable	0

It is a feature to stop the actuator completely in positioning by conducting electricity considering the influence of external force.

It works to reduce the power consumption in a situation such as when the payload is low. [Refer to 5.2.2 Automatic Current Reduction Feature]

[96] Command Output Complete Judgement Time in Non-Positioner Mode (Parameter No.187)

No.	Name	Unit	Input Range	Default factory setting
187	Command Output Complete Judgement Time in Non-Positioner Mode	ms	0 to 255	0

This parameter is exclusively used for Pulse Train Control Mode.

[Refer to 3.3.5 Parameter Settings Required for Advanced Operations]

[97] Network Number (Parameter No.188)

No.	Name	Unit	Input Range	Default factory setting
188	Network Number	-	0 to 239	Separate volume

This parameter is exclusively used for the Field Network (CC-Link IE Field).

[Refer to separate volume, CC-Link IE Field Instruction Manual (ME0389)]

[98] Actuator recognition function (Parameter No.192)

No.	Name	Unit	Input Range	Default factory setting
192	Actuator recognition function	–	0: Disable 1: Enable	0

Invalid/valid of Actuator Information Manager Feature should be set up.

When the actuator is not applied for Actuator Information Manager Feature or this feature is not to be used, do not change the setting from 0 (Initial setting).

Alarm Code 0A1 "Parameter data error" should occur when this parameter is set to 1 and an actuator not applicable for Actuator Information Manager Feature is connected.

[Refer to 5.3 Actuator Information Management Function]

7.3 Servo Adjustment

The parameters are preset at the factory before shipment so that the actuator operates stably within the rated (maximum) transportable weight. However, the preset setting cannot always be the optimum load condition in the actual use. In such cases, servo adjustment may be required. This section describes the basic servo adjustment method.

 **Caution:** Rapid and excessive settings are dangerous. They may cause devices including the actuator to be damaged and/or people to be injured. Take sufficient note on the setting. Record settings during servo adjustment so that prior settings can always be recovered. When a problem arises and the solution cannot be found, please contact IAI.

No.	Situation that requires adjustment	How to Adjust
1	Takes time to finish positioning Positioning accuracy is not appropriate Shorter takt time is desired	<ul style="list-style-type: none"> Set "parameter No.55 "Position command primary filter time constant"" to "0" if it is set. Increase the value of "parameter No.7 "Servo gain number"". By setting a larger value, the following ability to the position command becomes better. Set the value to any of 3 to 10 roughly or up to 15 at the maximum. If the value is too large, an overshoot is caused easily and may cause noise or vibration. <u>If the value of "parameter No.7 "Servo gain number"" is increased, also adjust the "parameter No.31 "Velocity loop proportional gain"" in increasing direction to ensure the stability in the control system.</u> To increase the value of "parameter No.31 "Velocity loop proportional gain"" <u>by about approximately 20% of the default.</u> Prior to the setting, adjust "parameter No.7 "Servo gain number"".
2	Vibration is generated at acceleration/deceleration	<ul style="list-style-type: none"> The cause of the problem is excessive "acceleration/deceleration setting" or vulnerable structure of the unit on which the actuator is installed. If possible, reinforce the unit itself, first. Decrease the values of "acceleration/deceleration setting". Decrease the number of "parameter No.7 "Servo gain number"". If the "parameter No.7 "Servo gain number"" is too low, it takes long time to finish the positioning.
3	Speed is uneven during the movement Speed accuracy is not appropriate	<ul style="list-style-type: none"> Increase the value of parameter No.31 "Velocity loop proportional gain". By setting a larger value, the follow-up ability to the speed command becomes better. Setting too large value makes the mechanical components easy to vibrate. As a reference for the setting, increase the value little <u>by little by about approximately 20% from the initial setting.</u>

No.	Situation that requires adjustment	How to Adjust
4	<p>Abnormal noise is generated. Especially, when stopped state and operation in low speed (less than 50mm/s), comparatively high noise is generated.</p>	<ul style="list-style-type: none"> Input the "Torque Filter Time Constant". Try to increase by 50 as a reference for the setting. If the setting is too large, it may cause a loss of control system stability and lead the generation of vibration. <p>[Important] Prior to Adjustment: This phenomenon is likely to occur when the stiffness of the mechanical components is not sufficient. The actuator itself may also resonate if its stroke is over 600mm or it is belt-driven type. Before having an adjustment, check if:</p> <ol style="list-style-type: none"> The value for "parameter No.7 "Servo gain number"", "parameter No.31 "Velocity loop proportional gain"", or "parameter No.32 "Velocity loop integral gain"" are excessive. The stiffness of the load is sufficient as much as possible, or the attachments are not loosened. The actuator unit is mounted securely with a proper torque. There is no waviness on the actuator mounting surface.
5	<p>Trace precision is desired to be improved. Equi-speed performance is desired to be improved. Response is desired to be improved.</p>	<ul style="list-style-type: none"> Make the condition optimized with Parameter No.7 "Servo gain number" and Parameter No.31 "Velocity loop proportional gain" adjusted by referring to the way to adjust stated in No. 1 to 3 in the previous page. <p>[Reference] The most important factor is to select the actuator (motor). The servo is extremely sensitive to the inertia of the load. If the inertia moment of the load is too large in comparison with the inertia moment of the servo motor itself, the motor is highly affected by the load. This may cause the actuator to be controlled unstably. Therefore, to improve the precisions of the trace, position, speed and response of the actuator, the load inertia ratio must be made small. For high trace precision, equi-speed performance, and response of the actuator in such a use as application, it is better to use ball screws with small leads in the actuator as much as possible and an actuator of motor capacity higher by at least one level. The best method is to calculate the load inertia to select the proper actuator.</p>
6	<p>Large static friction of load makes actuator start slowly. Large load inertia makes response of actuator low at start and stop. Takt time is desired to be shortened.</p>	<ul style="list-style-type: none"> Set parameter No.71 "Feed forward gain". Select a value in the range from 10 to 50 roughly. The larger the setting value is, the smaller the deviation is. Then the response is improved. Setting a large value may cause vibrations and/or noises to occur. Set the feed forward gain in order to improve the response of the actuator further after adjusting Parameter No.7 "Servo gain number" and Parameter No.31 "Velocity loop proportional gain".

Chapter 8 Troubleshooting

8.1 Action to Be Taken upon Occurrence of Problem

Upon occurrence of a problem, take an appropriate action according to the procedure below in order to ensure quick recovery and prevent recurrence of the problem.

1) Status Display LED on Controller and PIO Check

○ : Illuminating × : OFF ☆ : Flashing

LED		Operation status	Status of PIO Output Signal	
SV (GN)	ALM (RD)		SV output (Servo ON)	*ALM output (Note 1)
×	×	Control power OFF		
		Servo OFF		
×	○	Motor drive power supply OFF	OFF	OFF
		Alarm (Operation cancellation level or more)		
		In the emergency stop	OFF	ON
×	☆	During crash detection	OFF	OFF
○	×	Servo ON	ON	ON
☆	×	Automatic servo is OFF (Note 2)	OFF	ON
○ (OR)		In initializing process at power being on	OFF	OFF

- 2) Check whether an alarm occurs on the host controller (PLC, etc.).
- 3) Check the voltage of the main power supply (24V DC).
- 4) Check the voltage of power supply for the PIO (24V DC).
- 5) Check the voltage (24V DC) of the power supply for brake (For the actuator with the brake).
- 6) Alarm Check^(Note1)
Check the alarm code on the teaching tool such as PC software.
- 7) Check the connectors for disconnection or connection error.
- 8) Check the cables for connection error, disconnection or pinching.
Before performing a continuity check, turn OFF the power (to prevent electric shocks) and disconnect the cables of measuring instruments (to prevent accidental power connection due to sneak current path).
- 9) Check the I/O signals.
Using the host controller (PLC, etc.) or a teaching tool such as PC software, check the presence of inconsistency in I/O signal conditions.
- 10) Check the noise elimination measures (grounding, installation of surge killer, etc.).
- 11) Check the events leading to the occurrence of problem^(Note 1), as well as the operating condition at the time of occurrence.
- 12) Analyze the cause.
- 13) Treatment

Note1: If parameter No.111 (Selection of using calendar function) is set to "1" (use), it is possible to know the date and time at which the alarm occurred.
Set the date and time from the teaching tool such as PC software at the first power-on of the controller.
The date and time data set once is retained for about 10 days if the power supply of the controller is OFF. If the setting is not conducted or the time data is lost, it will be the time passed since 0sec when the power is turned ON. Even if the date and time data is lost, the generated error code is retained.
Alarms subject to this function only include those in 8.4 Alarm List but do not include errors in the teaching tool such as PC software.

! Request:

In troubleshooting, exclude normal portions from suspicious targets to narrow down the causes. Check 1) to 11) described above before contacting us.

8.2 Fault Diagnosis

This section describes faults largely divided into four types as follows:

- (1) Impossible operation of controller
- (2) Positioning and speed of poor precision (incorrect operation)
- (3) Generation of noise and/or vibration
- (4) Impossible Communication.

8.2.1 Impossible Operation of Controller

Situation	Possible cause	Check/Treatment
At power-on, SV on the status indicator LEDs does not go ON.	(1) Proper power is not supplied. (2) Servo-on command (PIO) is not input to IAI controller. 1) 24V DC power for PIO is not supplied. 2) Poor contact of flat cable 3) The operation mode setting switch on the front panel is on "MANU" side. (3) Occurrence of alarm. (4) During emergency-stop. 1) Was the emergency-stop switch. 2) EMG- on the power supply connector is not connected.	(1) Ensure that appropriate voltage is supplied and the wiring is in the right condition. [Refer to 2.3.1 Wiring Layout of Power Supply Connector.] (2) 1) Check the PIO power voltage. When a large load is applied to one power source, there is a risk of power voltage drop or a shutdown of the output. 2) Are the PIO cable connectors inserted to the mating connectors securely? Check the input signals on the I/O monitor of the teaching tool such as PC software. <div style="border: 1px solid black; padding: 5px; margin: 5px 0;"> <p> Caution In I/O cable conduction check, do not widen female pins of the connectors. Failure to follow this may cause poor contact.</p> </div> 3) Can such operation as jogging be performed from the teaching tool such as PC software? Set the operation mode setting switch on the front panel and restart the controller. [Refer to Name for Each Parts and Their Functions.] (3) Check the error code with the teaching tool being connected and remove the cause by referring the alarm list. [Refer to 8.4 Alarm List.] (4) 1) Release the emergency stop switch. 2) Check the connection of the power connector (EMG-). [Refer to 2.3.1 Wiring Layout of Power Supply Connector.]

Situation	Possible cause	Check/Treatment
<p>ALM in the status display LEDs turns on when the power is supplied.</p>	<p>(1) Occurrence of alarm (2) During emergency-stop. 1) Was the emergency-stop switch. 2) EMG- on the power supply connector is not connected.</p>	<p>(1) Check the error code with the teaching tool being connected and remove the cause by referring the alarm list. [Refer to 8.4 Alarm List.] (2) 1) Release the emergency stop switch. 2) Check the connection of the power connector (EMG-). [Refer to 2.3.1 Wiring Layout of Power Supply Connector.]</p>
<p>The host controller (PLC) cannot control PIO (24V DC I/O).</p>	<p>PIO signal communication is disabled. 1) 24V DC power for PIO is not supplied. 2) Poor contact of flat cable 3) The operation mode setting switch on the front panel is on "MANU" side. 4) The +/- pins of 24V DC power for PIO are connected inversely.</p>	<p>1) Check the PIO power voltage. If a single power supply is connected with large load, the power supply voltage may drop or the output may be shut down depending on power units. 2) Are the PIO cable connectors inserted to the mating connectors securely? Check the input signals on the I/O monitor of the teaching tool such as PC software.</p> <div style="border: 1px solid black; padding: 5px; margin: 5px 0;"> <p> Caution In I/O cable conduction check, do not widen female pins of the connectors. Failure to follow this may cause poor contact.</p> </div> <p>3) Can such operation as jogging be performed from the teaching tool such as PC software? Set the operation mode setting switch on the front panel and restart the controller. [Refer to Name for Each Parts and Their Functions.] 4) Reverse connection of the PIO power supply does not affect the input circuit but makes the output circuit faulty. Check if the I/O of the host controller (PLC) operates normally.</p>

[In the case of Positioner Mode]

Situation	Possible cause	Check/Treatment
Both position No. and start signal are input to the controller, but the actuator does not move.	<p>There is a problem either in PIO signal treatment, position table setting or operation mode selection.</p> <ol style="list-style-type: none"> 1) Servo OFF condition 2) The pause signal is OFF. 3) Positioning command is issued to a stop position. 4) There is no positioning data set to the commanded position number. 5) Target position number and the start signal commanded at the same time 	<ol style="list-style-type: none"> 1) Is the status display LED SV turned ON? [Refer to Name for Each Parts and Their Functions] Turn ON the servo-on signal SON of PIO. 2) Operation is available when PIO pause signal *STP is ON and pause when it is OFF. Turn it ON. [Refer to 2.1.2.] 3) Check the sequence or the settings of the position table. 4) It will generate Alarm Code 0A2 "Position Data Error". Conduct the position table setting. 5) Have 6ms or more between the target position number command and start signal command.

(Note) Refer to 2.1.3 [3] PIO Circuit for PIO signal.

[In the case of Pulse Train Control Mode]

Situation	Possible cause	Check/Treatment
In spite of inputting pulse-train to the controller, the actuator does not move.	<p>PIO signal processing or parameter setting is incorrect.</p> <ol style="list-style-type: none"> 1) Servo OFF condition 2) The pause signal is OFF. 3) The pulse-train type, a parameter, is selected incorrectly. 4) The positive/negative logic of pulse-train, a parameter, is selected inversely. 5) The unit moving distance per pulse, which is a setting condition of electronic gear ratio, a parameter, is too small. 	<ol style="list-style-type: none"> 1) Is the status display LED SV turned ON? [Refer to Name for Each Parts and Their Functions] Turn ON the servo-on signal SON of PIO. 2) Operation is available when PIO pause signal *STP is ON and pause when it is OFF. Turn it ON. [Refer to 2.1.2.] 3) Check the pulse train type. [Refer to 3.3.4 [2] Format Settings of Command Pulse Train.] 4) Check the positive/negative logic of pulse-train. (Host units supplied by some manufacturers have positive/negative logic opposite to our logic. Reserve the logic setting and try the operation.) [Refer to 3.3.4 [2] Format Settings of Command Pulse Train.] 5) Do not make the unit moving distance less than the resolution of the encoder. The actuator does not move unless pulses by the resolution of the encoder are input. [Refer to Caution in 3.3.4 [1] Electrical Gear Setting] <p>(Note) In case of 3) or 4), the actuator may not sometimes operate smoothly. You may not find case 5) when the actuator is moved for a long distance at a high frequency.</p>

(Note) Refer to 2.2.3 [3] PIO Circuit for PIO signal.

[Startup Adjustment with Teaching Tool when Control Circuit Incomplete]

Situation	Possible cause	Check/Treatment
<p>Operation is not performed even though the teaching tool is connected, and power to the controller motor and control circuit is supplied. (the emergency stop switch is released on the teaching tool)</p>	<p>Cable treatment or mode selection. 1) Emergency stop condition 2) Servo OFF condition 3) In pause</p>	<p>1) Supply 24V DC to EMG-terminal of the power connector.</p> <div style="border: 1px solid black; padding: 5px; margin: 5px 0;"> <p> Warning If the process of 1) is conducted, put back the setting as soon as the adjustment work is finished. Starting the operation without putting it back may cause a serious accident since the emergency stop is set invalid.</p> </div> <p>2) 3) Put the operation mode switch on the front panel of the controller to "MANU" side, and select the teach mode on the teaching tool.</p>

8.2.2 Positioning and Speed of Poor Precision (Incorrect Operation)

Situation	Possible cause	Check/Treatment
Completion of operation on the way to home return	In the home return of our standard specification, the actuator is first pressed to the mechanical end, moved oppositely, and subject to positioning stop at the home position. Therefore, the product may judge as the mechanical end even though it is still on the way when the load is large and interfere with surrounding object. 1) A load exceeding its rating weight is installed on the actuator. 2) It is touched to interference in the way of the run. 3) Torsion stress is applied to guide due to improper fixing method of the actuator or uneven fastening of bolts. 4) The sliding resistance of the actuator itself is large.	1) Reduce the load. 2) Remove the interference. 3) Loosen the fixing bolts once and check whether the slider can move smoothly. If the slider can move smoothly, check if there is a deformation on the attached surface, and install the actuator again following the instructions stated in Instruction Manual. 4) Please contact IAI.
Shocks at start and/or stop.	Acceleration/deceleration is set too high.	Decrease the settings of acceleration/deceleration.
Overshoot during deceleration to stop.	The load inertia is large.	Decrease the setting of deceleration.
Positioning of poor precision	1) [Refer to 7.3 Servo Adjustment.] 2) For the pulse motors other than high-resolution encoder, positioning should complete once the encoder value reaches ± 4 counts of the target position. If higher accuracy is required for positioning, activate the full servo function. [Refer to the 5.2.1 Automatic Servo-off and Full Servo Functions for the details] (Note) When the pulse-train operation mode is selected, first adjust pulse-train commands.	
Uneven speed during movement	[Refer to 7.3 Servo Adjustment.]	
Acceleration/deceleration not smooth (bad speed response)		
Trace of poor precision	(Note) When the pulse-train operation mode is selected, first adjust pulse-train commands.	

[In the case of Positioner Mode]

Situation	Possible cause	Check/Treatment
Positioning at a position different from that of commanded position No.	PIO signal processing is incorrect. 1) Start signal CSTR is input too early after position No. command. Or position No. command and start signal are input concurrently. 2) The correct position No. is not specified due to PIO signal disconnection or poor connector contact.	1) The stop position may be set for another purpose. Input the start signal after the controller fully reads the position number. [Refer to 3.2.4 Operation with the Position No. Input and Caution in Use and 9.5 Example of Basic Positioning Sequence.] 2) Check the input signal on I/O monitor on the teaching tool.
Complete signal PEND is not output even though positioning process is completed.	PIO signal processing is incorrect. 1) Start signal CSTR is not turned OFF.	1) Make the start signal CSTR turned OFF before completing the positioning process by the turn-off of positioning complete signal PEND after starting operation, and so on.

[In the case of Pulse Train Control Mode]

Situation	Possible cause	Check/Treatment
The actuator does not stop at the command position.	PIO signal processing or parameter setting is incorrect. 1) Incorrect electronic gear ratio 2) Acceleration/deceleration is set incorrectly in the host controller. 3) Noise 4) The pulse-train type, a parameter, is selected incorrectly. 5) The unit moving distance per pulse, which is a setting condition of electronic gear ratio, a parameter, is too small.	1) Check the setting of electronic gear ratio. The host controller also has the electronic gear ratio parameter. Set the electronic gear ratio not to be inconsistent with that of the host controller. In addition, reduce the electronic gear ratio as much as possible. If not, data overflow may occur in arithmetic processing to disable correct positioning. [Refer to 3.3.4 [1] Electrical Gear Setting.] 2) The actuator operates at the speed and acceleration/deceleration based on the frequency of input pulses. Check if the acceleration/deceleration set in the host controller exceed the rating acceleration/deceleration of the actuator. 3) Noise can be misread as the pulse if it jumps into the pulse train. Take proper measures against noise. [Refer to 1.7 Noise Elimination and Mounting Method.] Check the cable connection between the controller and AK-04 if AK-04 is used. <ul style="list-style-type: none"> • Cable length : 50mm or shorter recommended (as short as possible) • Shield treatment : Use the shield treatment wire. 4) Check the pulse-train type. [Refer to 3.3.4 [2] Format Settings of Command Pulse Train.] 5) Do not make the unit moving distance less than the resolution of the encoder. The actuator does not move unless pulses by the resolution of the encoder are input. [Refer to Caution in 3.3.4 [1] Electrical Gear Setting] (Note) In case of 2) or 3), the actuator may not sometimes operate. You may not find case 4) when the actuator is moved for a long distance at a high frequency.
The actuator does not reach the command position when operated with extremely low speed.	To avoid unnatural move, the actuator would not move unless the differential pulse becomes 3 pulses or more.	Set to the full-servo mode. (Set Parameter No.53 stop mode initial setting to 4, and position table stop mode set to 4.)

8.2.3 Generation of Noise and/or Vibration

Situation	Possible cause	Check/Treatment
Generation of noise and/or vibration from actuator itself	Noise and vibration are generated by many causes including the status of load, the installation of the actuator, and the rigidity of the unit on which the actuator is installed.	Servo adjustment may improve the situation. [Refer to 7.3 Servo Adjustment.] It may be improved with setting to Full Servo Mode if the case occurs during deceleration and stop. [Refer to 5.2 Power-saving Function]

[In the case of Positioner Mode]

Situation	Possible cause	Check/Treatment
Vibrations of load	1) Acceleration/deceleration is set too high. 2) The installation structure and/or the installed load are easily affected by acceleration/deceleration.	1) Decrease the settings of acceleration/deceleration.

[In the case of Pulse Train Control Mode]

Situation	Possible cause	Check/Treatment
Vibrations of actuator or load	Acceleration/deceleration is set too high.	Decrease the setting of acceleration/deceleration in the host controller.
Generation of noise during acceleration	The host controller has no acceleration/deceleration function or does not have acceleration/deceleration function from speed 0. (Some positioning units have acceleration/deceleration function but cannot use the function from speed 0. Note this when you select a positioning unit.)	[Refer to 7.3 Servo Adjustment No.7]

8.2.4 Impossible Communication

Situation	Possible cause	Check/Treatment
<ul style="list-style-type: none"> • Not connectable with host machine 	<ol style="list-style-type: none"> 1) Communication rates do not match. 2) The machine number (station number) is set to be duplicate with that of another unit or out of the range. 3) Parameter No.17 “Minimum delay time for slave transmitter activation” is set incorrectly. 4) Poor wiring or disconnection of communication cable 	<ol style="list-style-type: none"> 1) Set the communication rate to match that of the host machine. [Refer to the Instruction Manual of the host unit.] 2) Correct the unit number (station number) setting. Machine numbers (station numbers) vary depending on communication modes. Refer to the Instruction Manual of each communication mode.^(Note 1) 3) Set the value in Parameter No.17 smaller (2 as a reference) if the response timeout error is being issued in the host system. In any other cases, increase or decrease the value at will to change the send/receive timing. (If the operation is performed properly, the transmission cycle of the host is too fast. Always check the response of PCON before next transmission.) 4) Review the wiring again. Check if termination resistances are connected to network terminals with correct values.

Note 1 Refer to the following Instruction Manual for communications:

- CC-Link Separate volume, CC-Link Instruction Manual
- CC-Link IE Field Separate volume, CC-Link IE Field Instruction Manual
- CompoNet Separate volume, CompoNet Instruction Manual
- DeviceNet Separate volume, DeviceNet Instruction Manual
- EtherCAT Separate volume, EtherCAT Instruction Manual
- EtherNet/IP Separate volume, EtherNet/IP Instruction Manual
- MECHATROLINK- I / II Separate volume, MECHATROLINK- I / II Instruction Manual
- PROFIBUS-DP Separate volume, PROFIBUS-DP Instruction Manual
- PROFINET IO Separate volume, PROFINET IO Instruction Manual
- MECHATROLINK-III Separate volume, MECHATROLINK-III Instruction Manual
- RS485 Section 9.1

8.3 Alarm Level

The alarms are classified to 3 types of levels by the content of the error.

Alarm level	ALM lamp	*ALM signal	Status when an error occurred	Content of alarm
Message (Note 1)	OFF	No output	No stop	Alarm of maintenance output such as battery voltage drop or the teaching tool such as PC software [Refer to Instruction Manual of each tool for details.]
Operation release	ON	Output	Servo OFF after deceleration to stop	Reset the alarm by the PIO or teaching tool.
Cold start	ON	Output	Servo OFF after deceleration to stop	Software reset or power reconnection by teaching tool. Home return is required for any actuators of incremental specification.

 **Caution:** Reset each alarm after identifying and removing the cause.
If the cause of the alarm cannot be removed or when the alarm cannot be reset after removing the cause, please contact IAI.
If the same error occurs again after resetting the alarm, it means that the cause of the alarm has not been removed.

Note 1 An output will be made to PIO (OUT15) when Parameter No.156 Torque Check/Light Malfunction Output is set to 1 and the controller is in either of the following conditions:

- When satisfying the conditions to generate the message level alarm described in (8.4) in the next page

8.4 Alarm List

Alarm Code	Alarm Level	Alarm Name	Cause/Treatment
02C	Message	Monitoring data type change command during monitoring	Cause : Changing data type was directed during monitoring by the monitoring function of PC software. Treatment : Stop the monitoring before changing data type.
02D		Monitoring related command in monitoring function invalid status	Cause : An attempt was made to perform monitoring in the state where the monitoring function is set to be ineffective. Treatment : Set parameter No.112 (Selection of monitoring mode) to "1" or "2" ("0": no use).
02E		RTC related command in RTC invalid status	Cause : An attempt was made to use the calendar in the state where the RTC (calendar) function was made ineffective. Treatment : Set parameter No.111 (Selection of use of calendar function) to "1" ("0": no use).
048		Driver overload alarm	Cause : There is a risk of overload with the current operation condition. Treatment : Lower the setting of acceleration/deceleration. Also, increase the frequency of pause.
049		Detection alarm	Cause : Motor current has reached the detection current set in the collision detection feature.
04C		FAN revolution threshold drop	Cause : The revolution of the fan has dropped. Treatment : Consider replacement of the fan.
04D		FAN total drive time exceeded	Cause : The total driving time of the fan on the controller over 2years. Treatment : The life of the fan should be 3years (reference). Consider replacement.
04E		Exceeded movement count threshold	Cause : The total number of the operation times exceeded the value set in Parameter No.147 "Total Movement Count Threshold".
04F		Exceeded operated distance threshold	Cause : The total number of the operation distance exceeded the value set in Parameter No.148 "Total Operated Distance Threshold".
05C		Receiving timeout	Cause : Valid data was not detected even after 5 seconds has passed since the start (header) of Modbus communication was detected.
05E		Delimiter error packet receive	Cause : Valid data cannot be detected with Modbus communication, or abnormal data was received.
069		Detection of realtime clock oscillation stop	Cause : The calendar function is stopped and the current time data is lost. Treatment : Set the time again. [Refer to the Instruction Manual of RC PC software.] (Note) This error is not registered in the alarm list.
06A		Realtime clock access error	Cause : The calendar function is not working properly because of noise or malfunction of consisting parts. Treatment : 1) Take proper measures against noise. 2) When the calendar function is not used, set parameter No.111 "Calendar function" to "0". 3) If the operation is not improved in use of the calendar function in spite of measures against noise, Please contact IAI.
06B		Maintenance information data error	Cause : The maintenance information (total movement count, total operated distance) is lost. Treatment : Please contact IAI.

Alarm Code	Alarm Level	Alarm Name	Cause/Treatment
080	Operation release	Move command in servo OFF	Cause : A move command was issued when the servo is OFF. Treatment : Issue a movement command after confirming the servo is ON (servo ON signal (SV) or position complete signal (PEND) is ON).
082		Position command in incomplete home return	Cause : A position move command was issued before home return was completed. Treatment : Issue a command after confirming that home return has been completed (HEND) is ON.
083		Numerical command in incomplete home return	Cause : An absolute position command was issued by numerical specification before home return was completed (direct command from Field Network). Treatment : Issue a numeric specification after performing home return operation and confirming the complete signal (HEND).
084		Absolute position move command when home return is not yet completed	Cause : A move command was issued when home return was still in progress. Treatment : Issue a movement command after performing home return operation and confirming the complete signal (HEND).
085		Position No. error during movement	Cause : A non-existing (invalid) position number was specified in the positioner mode. Treatment : Check the position table again and indicate an effective position number.
086		Move command while pulse train input is effective	Cause : Actuator operation was commanded via serial communication in pulse train mode. Treatment : Stop the actuator operation command via serial communication in pulse train mode.
090		Software reset during servo ON	Cause : A software reset command was issued when the servo was ON. Treatment : Issue a software reset command after confirming that the servo is OFF (SV signal is 0).
091		Position No. error in teaching	Cause : The position number out of the available range was selected in the teaching. Treatment : Select the position number from 63 or smaller.
092		PWRT signal detection during movement	Cause : The current position write signal (PWRT) was input in the teaching mode of PIO pattern 1 while the actuator was jogging. Treatment : Input the PWRT signal after confirming that the job button is not pressed and the actuator is stopped (MOVE output signal is OFF).
093		PWRT signal detection in incomplete home return	Cause : The current position write signal (PWRT) was input in the teaching mode of PIO pattern 1 when home return was not yet completed. Treatment : Input the HOME signal first to perform home return, and then input the PWRT signal after confirming that the home return has completed (HEND output signal is ON).
095	Cold start	DCLR signal detection with datum position movement command	Cause : 1) Datum position movement command (RSTR) signal is turned ON while Deviation Counter Clearing (DCLR) signal is ON. 2) DCLR signal is ON while datum position movement. Treatment : Turn on DCLR signal in appropriate timing.
09C		Servo ON command after encoder FRAM read/write	Cause : After entering a memo using the user note editing function (a function which allows memos to be saved on the actuator side), the servo was turned ON without controller restart or power reboot. Treatment : Restart the controller or reboot the power.

Alarm Code	Alarm Level	Alarm Name	Cause/Treatment
0A1	Cold start	Parameter data error	<p>Cause : The data input range in the parameter area is not appropriate.</p> <p>Example 1) This error occurs when the magnitude relationship is apparently inappropriate such as when 300mm was incorrectly input as the value of the soft limit negative side while the value of the soft limit positive side was 200.3mm.</p> <p>Example 2) It could occur when the soft limit negative side gets to 0 in case the Index Mode is changed to Normal Mode in the rotary axis. Set the soft limit negative side to a value -0.3mm is added to the outer side of the effective stroke. [Refer to 7.2 [2] Soft limit +, Soft limit -]</p> <p>Example 3) It could occur when the initial positioning band width [Refer to 7.2 [8]] is set lower than the minimum positioning band width in case an actuator of RCP2, RCP3, RCP4 or RCP5 Series is connected. Set the initial positioning band width at or higher than the minimum positioning band width (lead length ÷ number of encoder pulses: 800) ×3.</p> <p>Example 4) An actuator not applicable for Information Manager Feature was connected while Parameter No. 192 Actuator Recognition Function is set to "1: Enable". [Refer to 5.3 Actuator Information Management Function]</p> <p>Treatment : Change the value to the appropriate one.</p>
0A2	Operation release	Position data error	<p>Cause : 1) A move command was input when no target position was set in the "Position" field of a position No. in the position table. 2) The value of the target value in the "Position" field exceeded the Parameter No.3 and 4 "Soft limit set value". 3) A target position was specified in the "Position" field by relative coordinate in the solenoid valve mode 2 of PIO pattern 5.</p> <p>Treatment : 1) Set the target position. 2) Change the target position value to the one within the soft limit set value. 3) The target position cannot be set by relative coordinate (incremental feed).</p>

Alarm Code	Alarm Level	Alarm Name	Cause/Treatment																
0A3	Operation release	Position command data error	<p>Cause : 1) The number for command is out of the range when command was made with the direct numerical command.</p> <p>Treatment : 1) A code of a command that is out of the range should be shown in the detail address. Input an appropriate value by referring to these values.</p> <table border="1"> <thead> <tr> <th>Detailed Address (Command Item Code)</th> <th>Command Item</th> </tr> </thead> <tbody> <tr> <td>0F00</td> <td>Target Position</td> </tr> <tr> <td>0F02</td> <td>Command Speed</td> </tr> <tr> <td>0F04</td> <td>Acceleration</td> </tr> <tr> <td>0F06</td> <td>Deceleration</td> </tr> <tr> <td>0F08</td> <td>Positioning Width</td> </tr> <tr> <td>0F0C</td> <td>Pressing Current Limit Value</td> </tr> <tr> <td>0F0D</td> <td>Control Signal</td> </tr> </tbody> </table>	Detailed Address (Command Item Code)	Command Item	0F00	Target Position	0F02	Command Speed	0F04	Acceleration	0F06	Deceleration	0F08	Positioning Width	0F0C	Pressing Current Limit Value	0F0D	Control Signal
Detailed Address (Command Item Code)		Command Item																	
0F00		Target Position																	
0F02	Command Speed																		
0F04	Acceleration																		
0F06	Deceleration																		
0F08	Positioning Width																		
0F0C	Pressing Current Limit Value																		
0F0D	Control Signal																		
0A4	Command counter overflow	<p>Cause : The number of input command pulses exceeded the range of -134217728 to +134217728 (H'F8000000 to '07FFFFFF).</p> <p>Treatment : Attempt to make the value of the electrical gear ratio smaller (make the movement against the unit bigger).</p>																	
0A7	Command deceleration error	<p>Cause : Because there is not enough deceleration distance when the deceleration is changed to a lower setting during the operation, the actuator exceeded the soft limit when deceleration was made from the current position with the deceleration after the change.</p> <p>The cause is that the timing to make the next movement command when the speed was changed during the operation was late.</p> <p>Treatment : Make the timing earlier for the movement command for the deceleration speed change.</p>																	
0A8	Cold start	Unsupported motor/encoder types	<p>Cause : The motor connected to the controller is not applicable or the type of the encoder that the motor is connected is not applicable.</p> <p>Treatment : Please contact us if the alarm is issued even with the applicable actuator and the same problem happens again even after rebooting the power.</p>																

Alarm Code	Alarm Level	Alarm Name	Cause/Treatment
0B8	Cold start	Excitement detection error	<p>Cause : In this controller, the excitation detection starts when the servo is turned ON for the first time after the power is supplied. The detection is not finished after a certain time (set to Parameter No.29) being passed.</p> <ol style="list-style-type: none"> 1) Connection error or wire breakage of motor/encoder cables. 2) Brake is not released (when equipped with a brake). 3) Load to the motor is high due to external force. 4) Power was turned on while touching to the mechanical end. 5) The resistance in the actuator sliding operation is large. 6) Parameter No.22 Home Return Offset was set smaller than the initial value. <p>Treatment : 1) Check for the motor/encoder cable wiring condition.</p> <ol style="list-style-type: none"> 2) Supply 24V DC 150mA to the BKRLS terminal on the power supply connector and if you can see an improvement, it is considered the controller failure. Please contact IAI. 3) Confirm that there is no error in the mechanical part assembly condition. 4) Move the slider or the rod to a point where it would not hit the mechanical end and reboot the system. 5) If the loaded weight is within the allowable range, turn the power OFF and check the resistance in sliding operation by moving the slider with hand. 6) For Simple Absolute Type, the excitation detection is performed at the end of home return operation. If the Parameter No.22 Home Return Offset is set smaller than the initial setting, the actuator interferes with the mechanical end and excitation detection cannot be performed properly.
0BA	Operation release	Home sensor non-detection	<p>Cause : This indicates that the home-return operation of the actuator equipped with origin sensor (option except rotary actuator) is not completed in normal condition.</p> <ol style="list-style-type: none"> 1) Work is interfering with peripheral equipment in the middle of home return. 2) Large slide resistance of the actuator itself 3) Installation failure, breakdown or disconnection of the home sensor <p>Treatment : In the case that the work does not interfere with anything, the cause 2) or 3) is supposed. In such case, please contact IAI.</p>
0BE		Home return timeout	<p>Cause : Home return does not complete after elapse of a certain period after the start of home return.</p> <p>Treatment : This error does not occur in normal operation. The combination of the controller and actuator may be incorrect. Please contact IAI.</p>

Alarm Code	Alarm Level	Alarm Name	Cause/Treatment
0C0	Operation release	Actual speed excessive	<p>Cause : This indicates the number of motor rotation exceeded the number of allowable rotation.</p> <ol style="list-style-type: none"> 1) The slide resistance of the actuator is locally high. 2) The load is increased too much due to a external force. <p>With the reasons above, it can be considered a sudden speed increase has occurred before detecting the servo error.</p> <p>Treatment : Even though this would not occur in normal operation, check if there is any abnormality in the parts assembly condition. Also check if there is a possibility that an external force may be applied in the direction of the actuator movement.</p>
0C1		Servo error	<p>Cause : It indicates 2 seconds has passed without making a move since a move command was received.</p> <ol style="list-style-type: none"> 1) Connection error or wire breakage of motor/encoder cables. 2) Brake is not released (when equipped with a brake). 3) Load to the motor is high due to external force. 4) The resistance in the actuator sliding operation is large. <p>Treatment : 1) Check for the motor/encoder cable wiring condition. 2) Supply 24V DC 150mA to the BKRLS terminal on the power supply connector and if you can see an improvement, it is considered the controller failure. Please contact IAI. 3) Confirm that there is no error in the mechanical part assembly condition. 4) If the loaded weight is within the allowable range, turn the power OFF and check the resistance in sliding operation by moving the slider with hand.</p>
0C8	Cold start	Overcurrent	<p>Cause : The output current in the power circuit section is increased abnormally.</p> <p>Treatment : This alarm will not be generated in normal operation. It can be considered as the insulation degradation of the motor winding or malfunction of the controller. Please contact IAI.</p>
0C9		Overvoltage	<p>Cause : The voltage of the power regenerative circuit has risen above the threshold.</p> <p>Treatment : A malfunction of a component inside the controller can be considered. Please contact IAI.</p>

Alarm Code	Alarm Level	Alarm Name	Cause/Treatment
OCA	Cold start	Overheat	<p>Cause : This indicates overheat (90°C or more) of the components inside the controller.</p> <ol style="list-style-type: none"> 1) Operation is performed with the load condition exceeding the specified range. 2) High temperature around the controller. 3) Load to the motor is high due to external force. 4) A faulty part inside the controller. <p>Treatment : 1) Revise the operation condition such as decreasing the acceleration/deceleration speed. 2) Lower the ambient temperature of the controller. 3) Confirm that there is no error in the mechanical part assembly condition.</p> <p>(Note) This error would not normally occur. If it occurs, confirm there is not 1) to 3) above. If the same error is issued again even after confirming 1) to 3) is not in the condition, it is considered to be a malfunction. Please contact IAI.</p>
OCB		Current sensor offset adjustment error	<p>Cause : An error was detected on the current detection sensor while in initializing at the startup. Malfunction is considered on the current detection sensor and peripheral components.</p> <p>Treatment : Replacement of PC board or adjustment of offset is required. Please contact IAI.</p>
OCC		Control power source voltage error	<p>Cause : The control power voltage dropped less than the voltage drop threshold (120% of 24V DC = 28.8V).</p> <ol style="list-style-type: none"> 1) The voltage of 24V DC power supply is high. 2) A faulty part inside the controller. 3) During acceleration/deceleration and servo-on that use the remote sensing function of 24V DC power supply, the current consumption rises transiently. <p>Using the remote sensing function with a power supply with no enough current capacity may cause overvoltage responding to the current change.</p> <p>Treatment : 1) 2) Check the voltage of the power supply. 3) Think to use a power supply with enough current capacity or not to use the remote sensing function.</p> <p>In the case that the voltage is normal, please contact IAI.</p>
OCE	Operation release	Drop in control supply voltage	<p>Cause : The control power voltage dropped less than the voltage drop threshold (70% of 24V DC = 16.8V).</p> <ol style="list-style-type: none"> 1) The voltage of 24V DC power supply is low. 2) A faulty part inside the controller. <p>Treatment : Check the voltage of the power supply.</p> <p>In the case that the voltage is normal, please contact IAI.</p>

Alarm Code	Alarm Level	Alarm Name	Cause/Treatment
0D4	Cold start	Drive Source error	<p>Cause : Overcurrent is generated on the motor power supply line.</p> <ol style="list-style-type: none"> 1) Connection error on motor/encoder cables or short-circuit in internal wiring 2) Voltage of 24V DC power supply is unstable or connection error on power supply connector <p>Treatment : 1) Check wiring of motor/encoder cables or replace cables.</p> <ol style="list-style-type: none"> 2) Check the power supply voltage around the power supply connector on the controller or contact of the power supply connector. <p>Contact IAI in case the condition would not recover.</p>
0D5		Differential Counter Overflow with Home Return Incomplete	<p>Cause : This alarm indicates that the position deviation counter has overflowed.</p> <ol style="list-style-type: none"> 1) The speed dropped or stopped during JOG move due to an impact of external force, hit to the mechanical end or overload. 2) The excited-phase detection operation following the power-on is unstable. <p>Treatment : 1) This error occurs when the actuator cannot be operated as it is commanded. Check the load conditions such as if the work is touching to the surrounding object, or brake is properly released, and remove the cause.</p> <ol style="list-style-type: none"> 2) Overload is concerned. Revise the transportable weight.
0D6	Operation release	FAN error detection	<p>Cause : Error detected on heatsink fan inside the controller</p> <p>Treatment : It can be considered the end of fan life. Replace the fan. [Refer to 9.4.3 Replacement of Fan]</p>
0D8		Deviation overflow	<p>Cause : This alarm indicates that the position deviation counter has overflowed.</p> <ol style="list-style-type: none"> 1) The speed dropped or the actuator stopped due to the effect of external force or overload. 2) The excited-phase detection operation following the power-on is unstable. <p>Treatment : 1) This error occurs when the actuator cannot be operated as it is commanded. Check the load conditions such as if the work is touching to the surrounding object, or brake is properly released, and remove the cause.</p> <ol style="list-style-type: none"> 2) Overload can be concerned. Revise the transportable weight and redo the home-return operation.
0D9		Software stroke limit exceeded	<p>Cause : The current position of the actuator exceeds the software stroke limit.</p> <p>Treatment : Return the actuator to be within the range of the software stroke limit.</p>
0DC		Pressing motion range over error	<p>Cause : 1) After the pressing operation has complete, the force to push back is too large and the pushed back to the pressing start position ("Position" in the position table).</p> <ol style="list-style-type: none"> 2) The actuator touched the work during the approach movement before the pressing movement. <p>Treatment : 1) Revise the setting and adjust it so the force to push back gets smaller.</p> <ol style="list-style-type: none"> 2) Set the "Position" setting in front in the position table to shorten the approach distance.

Alarm Code	Alarm Level	Alarm Name	Cause/Treatment
ODF	Operation release	Collision detection	<p>Cause : Collision of actuator was detected.</p> <p>Treatment : Remove the cause of collision. If it is an unexpected detection, re-adjust the collision detection feature. [Refer to 5.1 Collision Detection Feature]</p>
OEO	Cold start	Overload	<p>Cause : 1) The work piece weight exceeds the rating, or load has increased due to external force. (If the detail code in the alarm list of the teaching tool is from 0001_H to 0008_H) 2) Brake is not released in case of actuator. (equipped with brake and also detail codes from 0001_H to 0008_H) 3) The slide resistance of the actuator is locally high. (Detail Code from 0001_H to 0004_H) 4) Lack of current amperage for 24V DC power supply (Detail Code 0004_H)</p> <p>Treatment : 1) Revise the work piece and peripherals, and remove the cause. 2) Turn on the brake release switch to confirm the brake gets released. In case that the brake does not get released, it can be considered a malfunction of the brake itself, breakage of the cable or malfunction of the controller. 3) If the work piece is in a condition that it can be moved manually with hand, try to move it to check if there is any spot that the sliding resistance is large. Check if there is any deformation on the attachment surface. Please contact IAI if this occurs with the actuator itself. 4) Voltage drop due to lack of current amperage, wire diameters or distance may be concerned. Check the current amperage and wire diameters.</p> <div style="border: 1px solid black; padding: 5px; margin-top: 10px;"> <p> Caution: Make sure to remove the cause before resuming the operation. In case that confirmation cannot be made that the cause is completely removed, leave the unit for 30 minutes or more before rebooting the power to avoid motor coil burnout.</p> </div>

Alarm Code	Alarm Level	Alarm Name	Cause/Treatment
0E5	Cold start	Encoder receipt error	<p>Cause : This shows the data was not received in normal condition from the encoder side to the controller.</p> <ol style="list-style-type: none"> 1) Breakage of encoder cable or connection error on connectors (If the detail code in the alarm list of the teaching tool is 0002_H.) 2) Effect of noise (Detail Code 0001_H) 3) Malfunction of component (communication part) inside the actuator 4) A faulty part inside the controller (communication part). 5) Initialization of battery-less absolute encoder is incomplete (Detail Code 000A_H) 6) Error occurred in communication with battery-less absolute encoder (Detail Code 000C_H) <p>Treatment : 1) Check if any wire breakage on a connector and the condition of wire connections. 2) Interrupt the power to the peripheral equipment and activate only the actuator. If any error does not occur, it might be caused by noise. Take proper measures against noise.</p> <p>If the cause is due to 3), 4) or 5), it is necessary to replace the actuator (motor part) or controller. 6) Check a breakage of encoder cable and connection on the connectors. For the high-resolution battery-less absolute encoder, check the capacity of 24V DC power supply and connection on power supply wiring.</p> <p>If the cause cannot be specified, please contact IAI.</p>
0E6		Encoder count error	<p>Cause : Error status was received in initial communication with battery-less absolute encoder</p> <p>Treatment : Reboot the power and conduct an absolute reset (home-return operation). Contact IAI in case the condition would not recover.</p>
0E8		A- and B-phase wire breaking	<p>Cause : Encoder signals cannot be detected correctly.</p> <ol style="list-style-type: none"> 1) The motor/encoder relay cable or supplied actuator cable is disconnected or its connector is not plugged in correctly. 2) The encoder itself is faulty. <p>Treatment : 1) Check if any wire breakage on a connector and the condition of wire connections. If the cables are normal, faulty encoder is suspected. Please contact IAI.</p>
0EB		Battery-less ABS error	<p>Cause : It is a condition that the battery-less absolute encoder has not detected the position information properly.</p> <p>Treatment : Check if there is any breakage on the connectors and the condition of connections. Malfunction of the encoder can be considered if the cables are in the normal condition. Please contact IAI.</p>
0ED	Operation release	Absolute encoder error detection 1	<p>Cause : The current position has changed while the controller is reading or saving the absolute data.</p> <p>Treatment : Avoid a condition that gives vibration to the actuator.</p>

Alarm Code	Alarm Level	Alarm Name	Cause/Treatment
0EE	Operation release	Absolute encoder error detection 2	<p>Cause : The position data cannot be detected properly in the Absolute applicable type encoder.</p> <ol style="list-style-type: none"> 1) When the power is supplied for the first time to Simple Absolute applicable type (before executing absolute reset) 2) Voltage drop of absolute battery (If the detail code in the alarm list of the teaching tool is 0001_H.) 3) Wire breakage or connector contact failure of motor/encoder relay cable or actuator enclosed cables, or attempted to insert and remove the cables in the simple absolute applicable type. (Detail Code 0002_H) 4) Changed the parameters of controller 5) Position data loss in absolute reset process in the battery-less absolute type. (Detail Code 0006_H) 6) Motor has replaced in battery-less absolute type, and the pairing ID registered in the controller has changed. (Detail Code 000B_H) <p>Treatment : 2) Supply the power for 72 hours or more and after charging the battery enough, perform the absolute reset operation. If the same failure occurs often even with enough battery charge, it is considered the end of the battery life. Replace the battery. Conduct an absolute reset for 1), 3), 4), 5) and 6). [Refer to Chapter 6 Absolute Reset and Absolute Battery]</p>
0EF		Absolute encoder error detection 3	<p>The encoder for the Simple Absolute applicable type cannot detect the position information properly. (Encoder overspeed error)</p> <p>Cause : The current position changed with a speed more than the rotation velocity setting by an external cause during the power shutoff.</p> <p>Treatment : Set the rotation velocity to a higher speed than what currently is. If the same failure occurs again, it is necessary to have an absolute reset. [Refer to Chapter 6 Absolute Reset and Absolute Battery]</p>
0F1		Field bus link error	<p>Cause : Error detected in field network link</p> <p>Treatment : Reboot the power. Please contact us if the problem is not solved with this action.</p>
0F2	Cold start	Field bus module error	<p>Cause : Error detected in field network circuit board</p> <p>Treatment : Check the parameter settings.</p>
0F3		Field bus module not detected	<p>Cause : Field network circuit board could not be detected.</p> <p>Treatment : Reboot the power. Please contact us if the problem is not solved with this action.</p>
0F4		Mismatched PCB	<p>The PCB is not applicable for the connected motor in the startup check.</p> <p>Cause : The actuator may not match the controller. Check the model.</p> <p>Treatment : Should this error occur, please contact IAI.</p>
0F5	Operation release	Nonvolatile memory write verify error	<p>It is verified at the data writing process to the non-volatile memory that the data inside the memory and the data to be written are matched. There was a mismatch detected in this process.</p> <p>Cause : Faulty nonvolatile memory.</p> <p>Treatment : When the error is caused even when the power is re-input, please contact IAI.</p>

Alarm Code	Alarm Level	Alarm Name	Cause/Treatment
0F6	Cold start	Nonvolatile memory write timeout	There is no response in the specified time duration during the data writing to the non-volatile memory. Cause : Faulty nonvolatile memory. Treatment : When the error is caused even when the power is re-input, please contact IAI.
0F8		Nonvolatile memory data destroyed	Abnormal data was detected during the nonvolatile memory check after starting. Cause : Faulty nonvolatile memory. Treatment : When the error is caused even when the power is re-input, please contact IAI.
0FA		CPU error	The CPU operation is not normal. Cause : 1) Faulty CPU. 2) Malfunction due to noise. Treatment : When the error is caused even when the power is re-input, please contact IAI.
0FC		Logic error (Faulty component)	The controller is not operating properly. Cause : 1) Malfunction due to the effect of noise, etc. 2) Malfunction of peripheral circuit components. Treatment : Turn the power OFF and reboot. If the error occurs again, check for presence of noise. If a spare controller is available, replace the problem controller with the spare controller. A recurring error with the spare controller suggests presence of noise. If the cause cannot be identified, please contact IAI.
100 to 1FF	Message	Alarm on teaching tool	[Refer to the Instruction Manual of teaching tool.]
200 to 2FF	Operation release	Alarm on teaching tool	[Refer to the Instruction Manual of teaching tool.]
300 to 3FF	Cold start	Alarm on teaching tool	[Refer to the Instruction Manual of teaching tool.]

Chapter 9 Appendix

9.1 Way to Set Multiple Controllers with 1 Teaching Tool

It is usually necessary to connect the teaching tool to the controllers one by one when making a setup to multiple controllers with one unit of teaching tool. In this section, explains how to perform the settings without connecting and disconnecting the plug.

- Requisite devices :
 - (1) SIO Converter (RCB-TU-SIO-A or RCB-TU-SIO-B) : 1 unit
 - (2) Controller Link Cable (CB-RCB-CTL002) : Required by the number of controllers

- Accessories
- | | | |
|--|---|--------|
| (1) 4-way junction (Manufactured by AMP 5-1473574-4) | : | 1 unit |
| (2) e-CON Connector (Manufactured by AMP 4-1473562-4) | : | 1 unit |
| (3) Terminal Resistance (220Ω, with a e-CON connector) | : | 1 unit |

Instead of the e-CON cable attached to the controller link cable, a terminal block may be used. In this configuration, disconnect the e-CON connector from the controller link cable.

9.1.1 Connecting Example

Caution: Supply 0V to the SIO converter and each controller from the same power source.

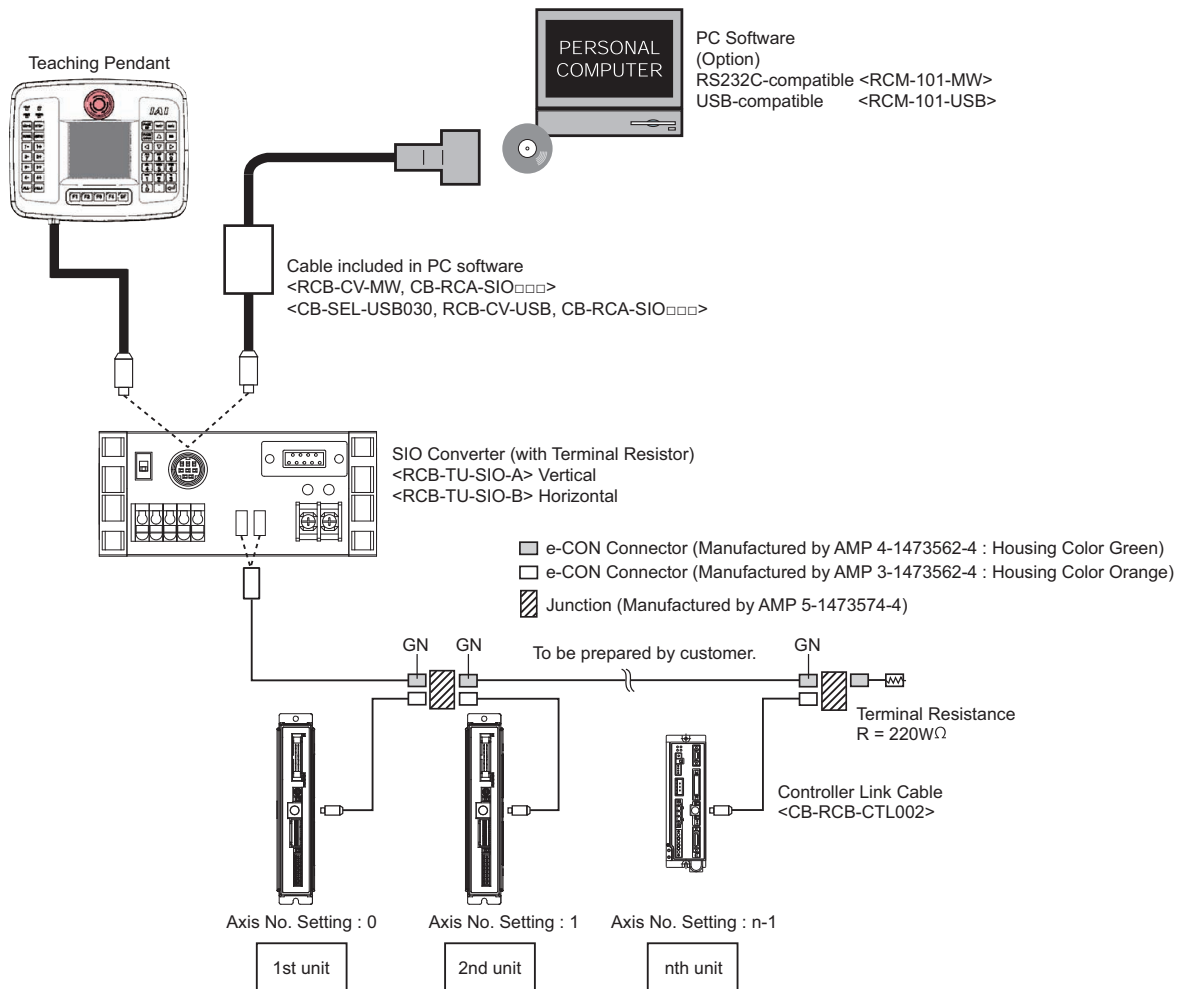

9.1.2 Detailed Connection Diagram of Communication Lines

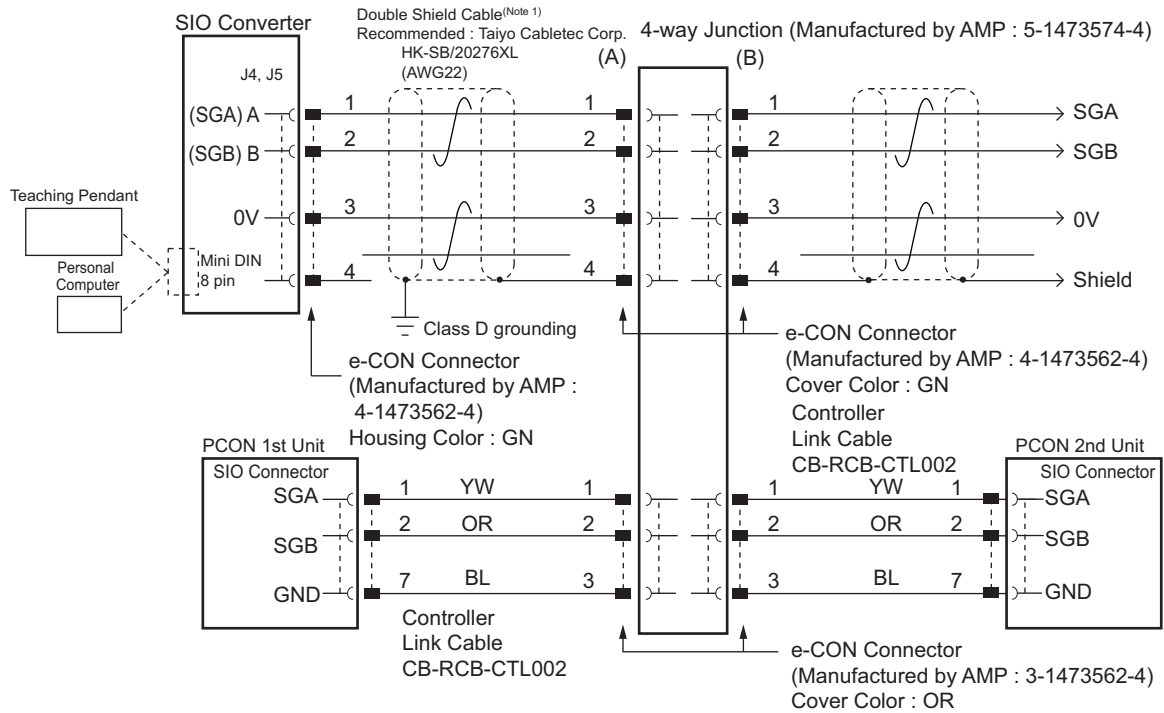

(Note 1) Apply a 2-pair shielded cable.
 When connecting a cable other than recommended to (A) and (B), make sure to use a hard-cored cable equivalent to the vinyl cable (KIV) dedicated for control devices with the sheath outer diameter from 1.35 to 1.60mm. Using cables with outer diameter out of the specification may cause poor contact to occur.

Caution: When cables with outer diameter out of the specification are used, use a terminal block instead of 4-direction junction. In this configuration, disconnect the e-CON connector of the link cable. If an error possibly caused by poor contact occurs frequently, replace the junction with the terminal block.

9.1.3 Axis No. Setting

Set an axis number by using the axis number setting switch on the front panel of PCON. Possible axis numbers range from 0 to F by 16 axes. After the setting, turn off the power of PCON and then on it again.

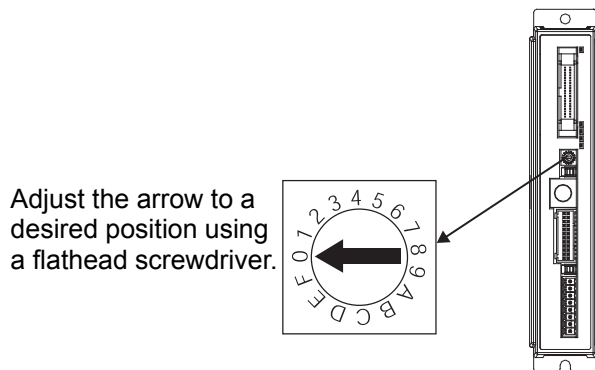

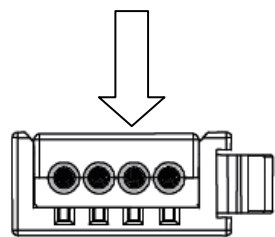
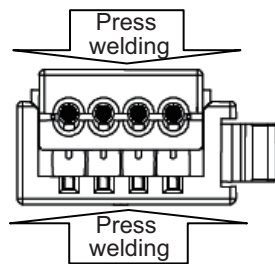
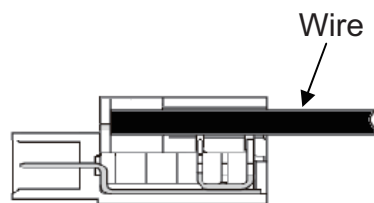
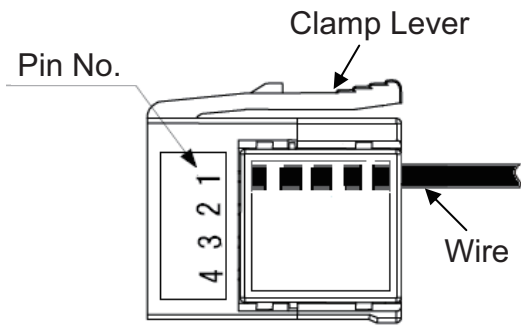

Caution: The axis number must be unique.

9.1.4 Handling of e-CON Connector (How to Connect)

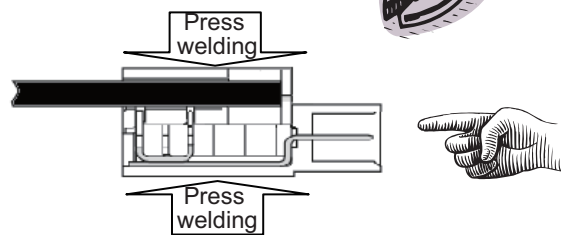

- 1) Check the applicable cable size.
Check the applicable cable. If it is not applicable, it may cause a connection failure or a breakage of the connector.
- 2) Check the pin numbers, do not reveal the sheath, and insert the cable till it reaches the end.
Revealing the sheath may cause a failure such as short circuit or cable fall out.



- 3) Use a (generally purposed) parallel plier with the width of 10mm or more to press-weld the cable from top and bottom.
Use the parallel plier from the direction of , grip it while checking the condition of press-welding to make sure the press is in right angle and press it until it becomes completely flat to the housing.
If the inserting is not enough, it may not be able to attach to the socket or may cause a contact failure.
- 4) After finishing the press-welding, pull the cable lightly to confirm that won't come out.

⚠ Caution :

- 1) e-CON connector cannot be reused once the press-welding is failed. Use a new connector to retry the press-welding.
- 2) When connecting to the socket, hold the connector with care not to touch the clamp lever, insert the connector in parallel to the socket until the clamp lever makes a “click” sound.
- 3) After joining to the socket, do not pull the cables or pull the connector without releasing the lock of the clamp lever.

9.1.5 SIO Converter

The SIO converter converts the communication mode from RS232C to RS485 or vice versa.

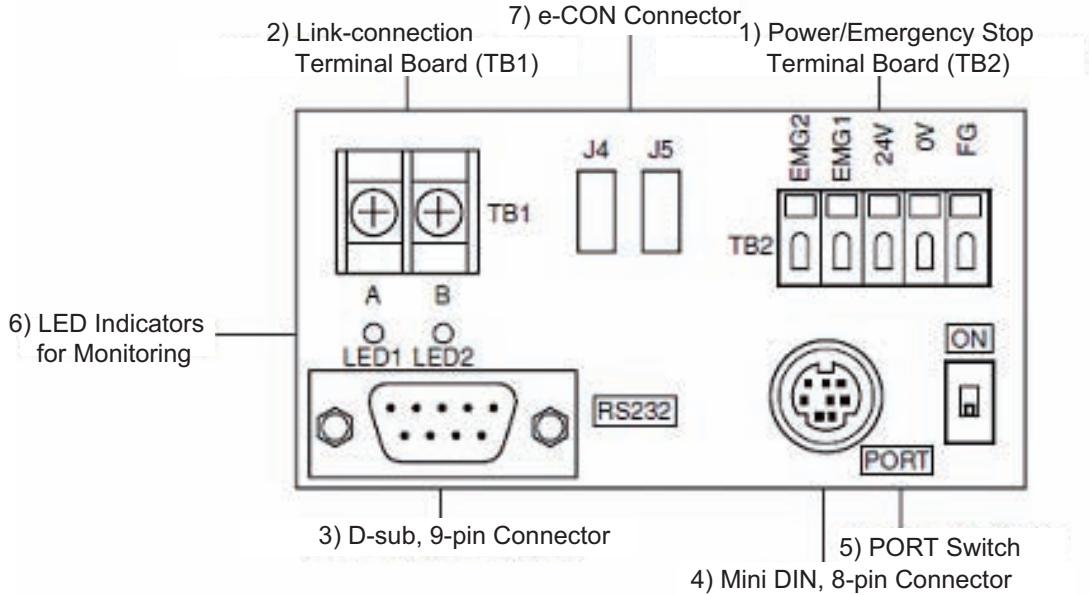

1) Power/Emergency Stop Terminal Board (TB2)

Symbol	Description
EMG1, EMG2	Turn the PORT switch ON to output the emergency stop switch signal, OFF to short-circuit EMG1 and EMG2. When applying the emergency stop switch of the teaching pendant to the emergency stop of the system, obtain the signal from here.
24V	Positive side of the 24V DC power supply (Power supply for the teaching pendant and conversion circuit.)
0V	Negative side of the 24V DC power supply
FG	Frame ground

(Note) 0V is connected to the pin No. 7 (GND) on the communication connector for the controller.

• Connection method

Use a connection cable satisfying the following specifications :

Item	Specification
Applicable wire	Solid Wire : $\phi 0.8$ to 1.2mm/Stranded : AWG Size 20 to 18 (0.5 to 0.75mm ²)
Stripped wire length	10mm

Use for Continuity Check

Insert a flathead screwdriver with a bit size of approx. 2.6mm.

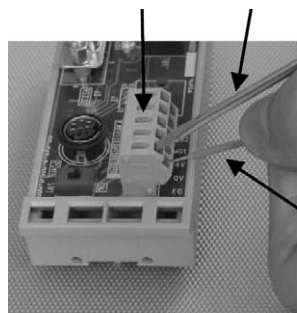

Connection Cable

- 2) Link-connection Terminal Board (TB1)
This is the connection port to obtain communication connection with the controller.
Connect terminal "A" on the left side to communication line SGA of the controller. (Terminal A is connected to pin 1 of (7) internally.)
Connect terminal "B" on the right side to communication line SGB of the controller. (Terminal B is connected to pin 2 of (7) internally.)
Use a twisted pair shielded cable for the connection of SGA and SGB to TB1.
- 3) D-sub, 9-pin connector
A connection port with the PC. (RS232C)
It is used when the operation is conducted with using SIO communication.
- 4) Mini DIN, 8-pin connector
This connector is connected to PC software, teaching pendant.
- 5) PORT Switch
The PORT switch is used to exchange enable/disable of connector (4).
Set the switch to ON if connector (4) is used or OFF if not used.
The switchover of valid/invalid on the teaching pendant is held at the same time as the emergency stop button switch signal output (between EMG1 and 2).
- 6) LED Indicators for Monitoring
LED1 : Lights/blinks while the controller sends signals.
LED2 : Lights/blinks while signals are sent from the RS232C connector.
- 7) e-CON Connector
It is used when connecting to the controller with e-CON connector without using 2).

9.1.6 Communications Cable

1) Controller Link Cable (CB-RCB-CTL002)

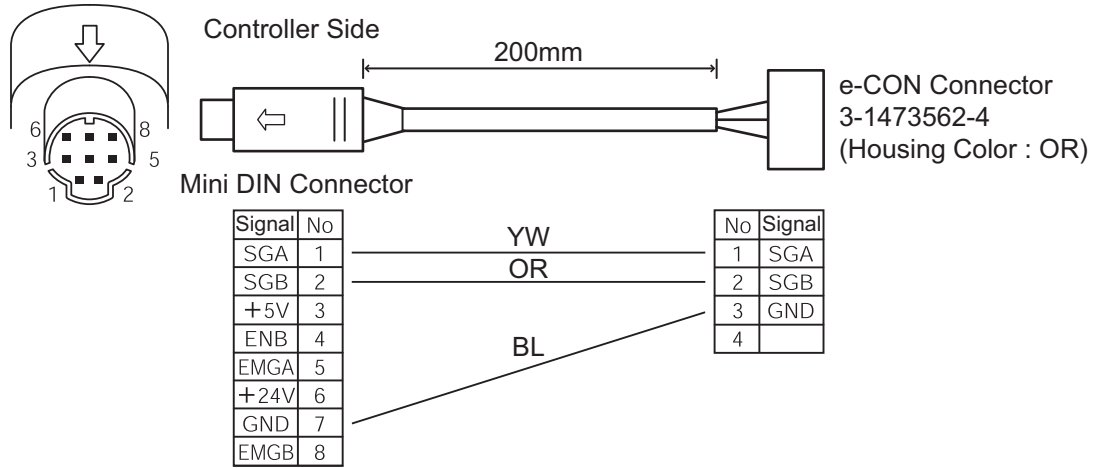

9.1.7 External Dimension

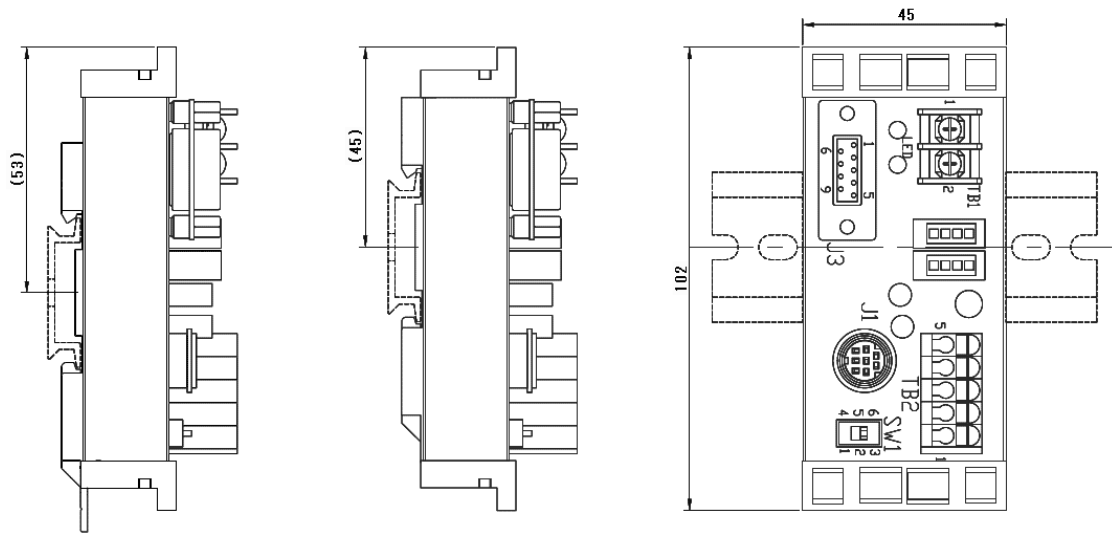

(Leg Element Bottom Side)

(Leg Element Top Side)

9.2 Conformity to Safety Category

In this section shows an example of a circuit using the dedicated teaching pendant. However, it is not possible for us to check the conformity of our product to the condition of your system. Therefore, it is necessary that the user construct the circuit considering the condition of use and the categories to be applied.

[1] System Configuration

In the case it is necessary to construct a system complying with Safe Category (ISO12100-1), use the following teaching pendant (Model: TB-02D, TB-01D (R) or CON-PGAS).

Also, TP adapter (Model : RCB-LB-TGS) is required.

The system can conform to up to safety category B to 4 (ISO12100-1) by changing connections of system I/O connectors.

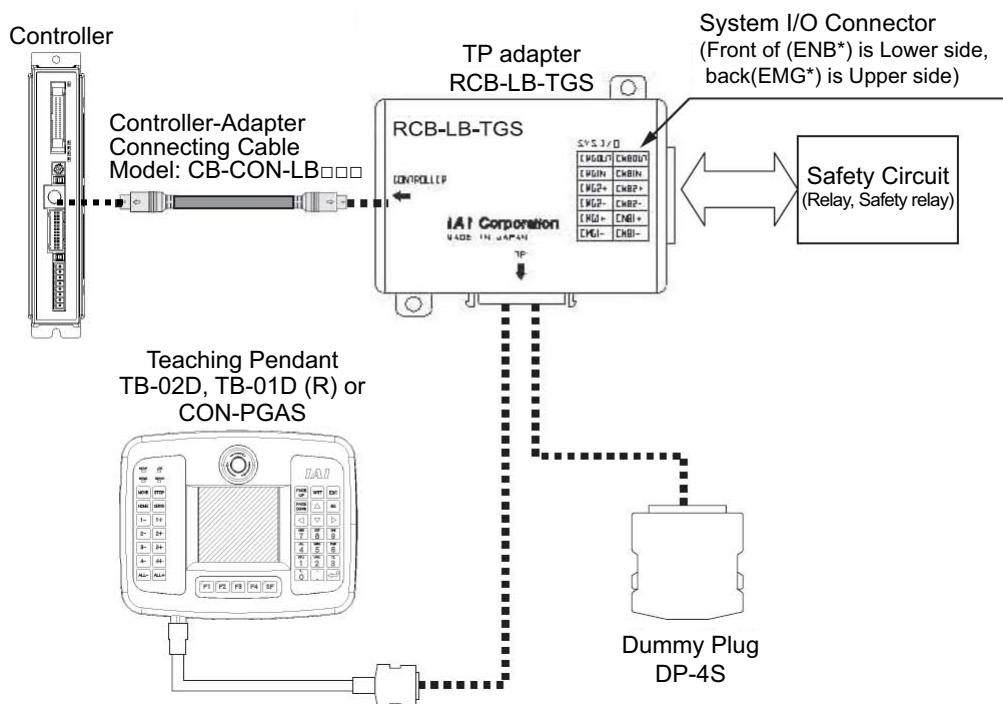

[2] Wiring and Setting of Safety Circuit

(1) Power supply

To use safety relays and/or contactors of 24V DC specification in the safety circuit, the control power supply should be used only for the circuit as much as possible. (Do not use the same power source as the driving power supply for this controller.)

It is the risk prevention treatment preparing for the cases such as the operation error of the safety circuit caused by not enough power capacity.

(2) Specification of system I/O connector for TP adapter

Connector Name		System I/O Connector		Applicable Wire
Upper side (EMG side)	Cable side	FMC1.5/6-ST-3.5 ^(Note 1)	Phoenix Contact	AWG24 to 16 (0.2 to 1.25m ²)
	TP adapter side	MCDN1.5/6-G1-3.5P26THR		
Lower side (ENB side)	Cable side	FMC1.5/6-ST-3.5 ^(Note 1)		
	TP adapter side	MCDN1.5/6-G1-3.5P26THR		

	Pin No.	Signal name	Description
Upper side (EMG side)	1	EMG1-	Emergency stop contact 1 (30V DC or less, 100mA or less)
	2	EMG1+	
	3	EMG2-	Emergency stop contact 2 (30V DC or less, 100mA or less)
	4	EMG2+	
	5	EMGIN	Emergency stop detection input
	6	EMGOUT	24V power supply output for emergency stop detection input
Lower side (ENB side)	7	ENB1-	Enable contact 1 (30V DC or less, 100mA or less)
	8	ENB1+	
	9	ENB2-	Enable contact 2 (30V DC or less, 100mA or less)
	10	ENB2+	
	11	ENBIN	Enable detection input
	12	ENBOUT	24V power supply output for enable detection input

Note 1 Connectors on the cable side are attached under conditions where initial wiring has been conducted.

In order to support each category, remove the initial wiring and wire your safety circuit.

• Upper side (EMG) connector

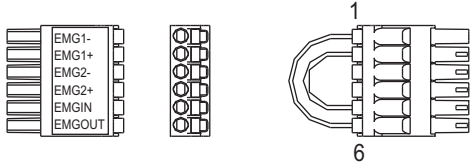

• Lower side (ENB) connector

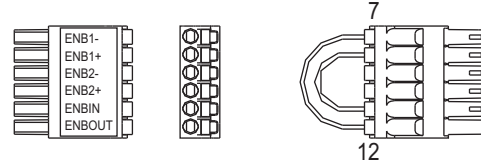

Wiring	Color	Signal	No.
AWG24	YW	EMG1-	1
	YW	EMG1+	2
	—	EMG2-	3
	—	EMG2+	4
	YW	EMGIN	5
	YW	EMGOUT	6

Wiring	Color	Signal	No.
AWG24	YW	ENB1-	7
	YW	ENB1+	8
	—	ENB2-	9
	—	ENB2+	10
	YW	ENBIN	11
	YW	ENBOUT	12

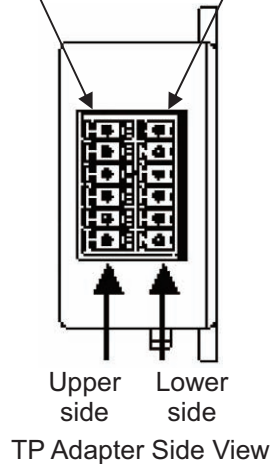

(3) Connection of dummy plug of TP adapter

When operating the controller with AUTO Mode, make sure to connect the enclosed dummy plug (DP-4S).

(4) Enable function*

If you are using the enable function, set it to Enable using the controller parameter.

Parameter No.42 Enable function

0 ... Enable

1 ... Disable [Default setting at shipment]

* Enable function : It is the function to monitor the status of the signal (safety switch, dead man's switch on teaching pendant, etc.) to permit the devices to operate.

[3] Examples of Safety Circuits
 1) In case of category 1

TB-02D, TB-01D(R), CON-PGAS
 (or Dummy plug : DP-4S)

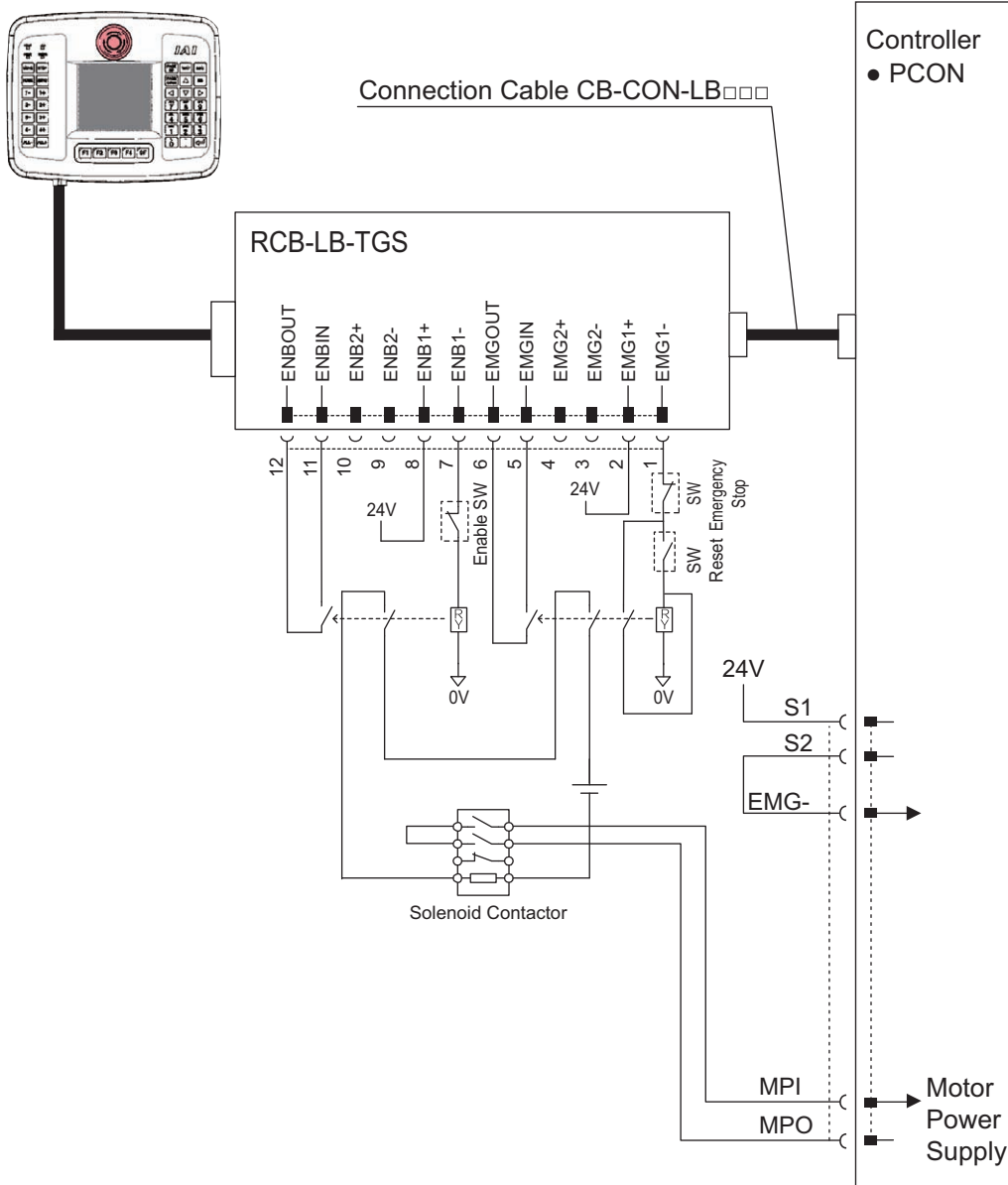

- Detailed category 1 circuit example

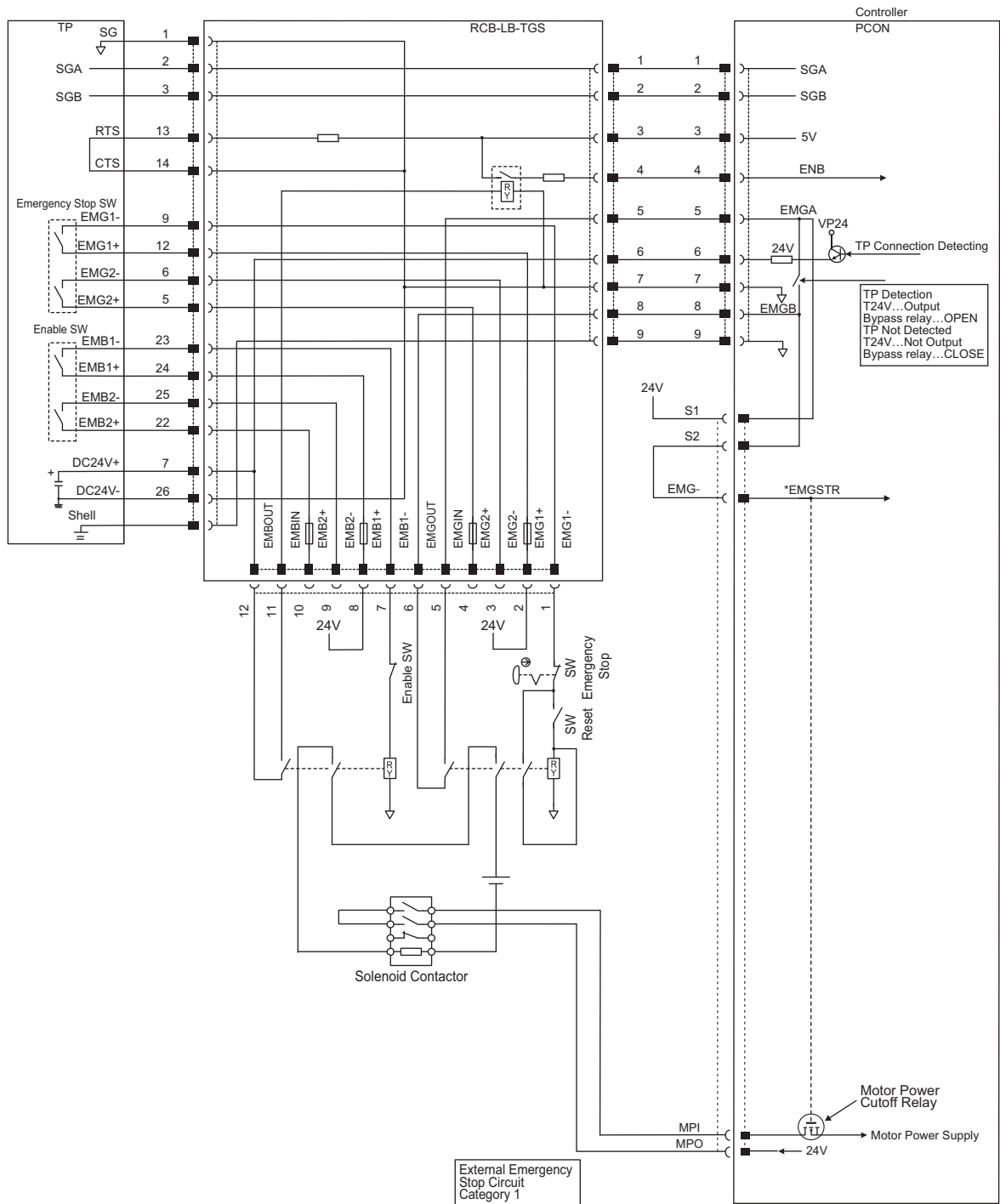

2) In case of category 2

TB-02D, TB-01D(R), CON-PGAS
(or Dummy plug : DP-4S)

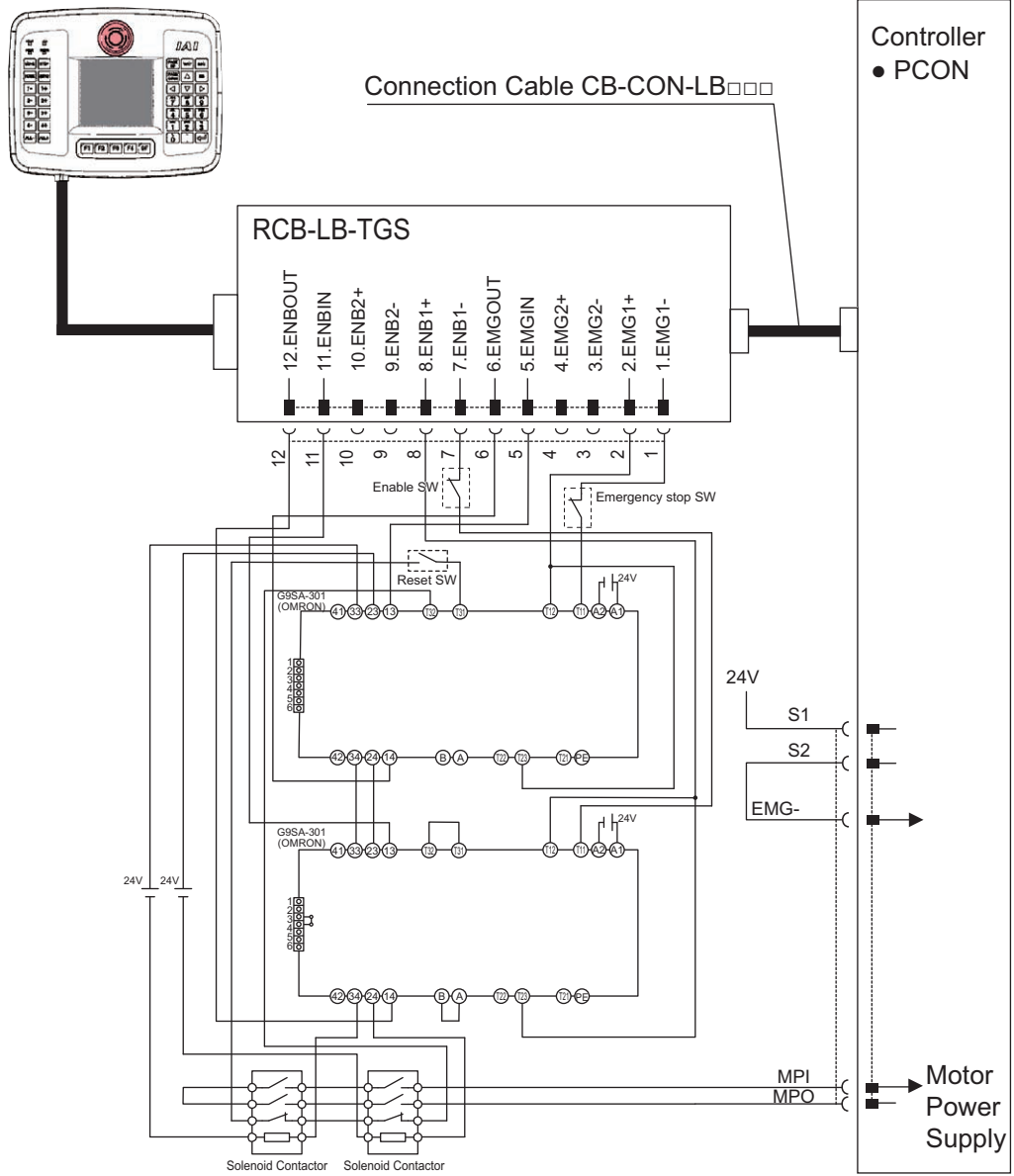

- Detailed category 2 circuit example

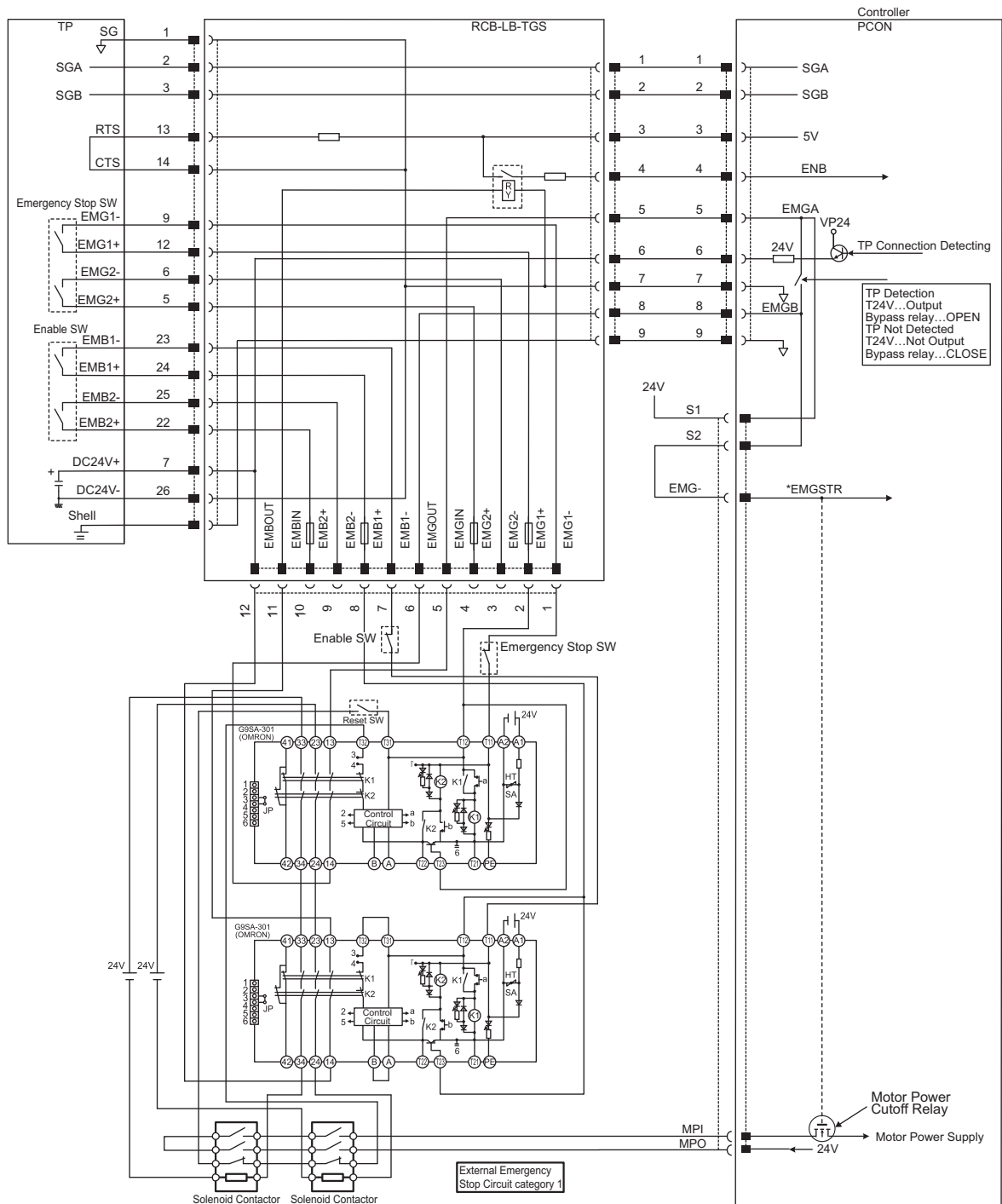

3) In case of category 3 or 4

TB-02D, TB-01D(R), CON-PGAS
(or Dummy plug : DP-4S)

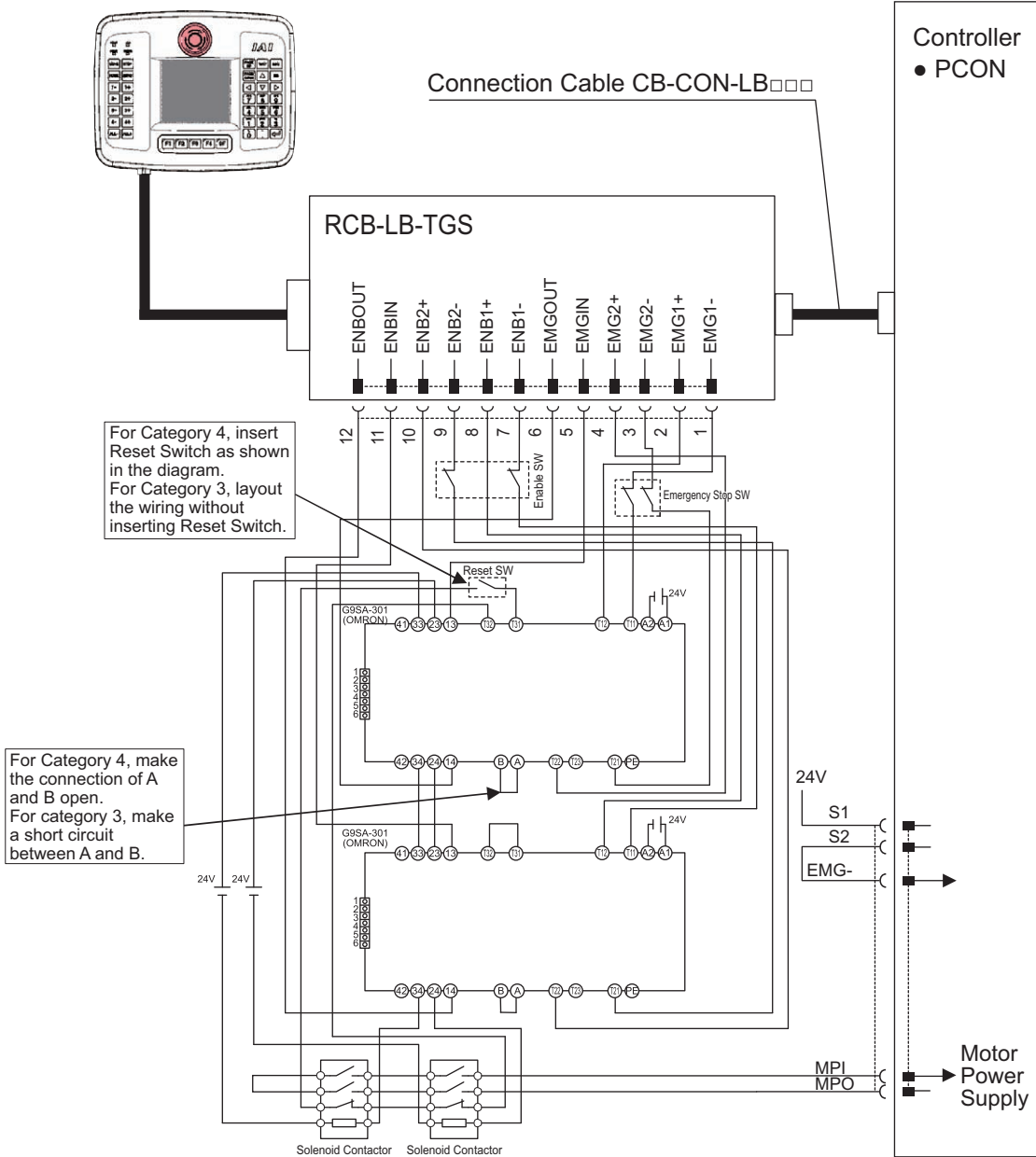

- Detailed category 3 or 4 circuit example

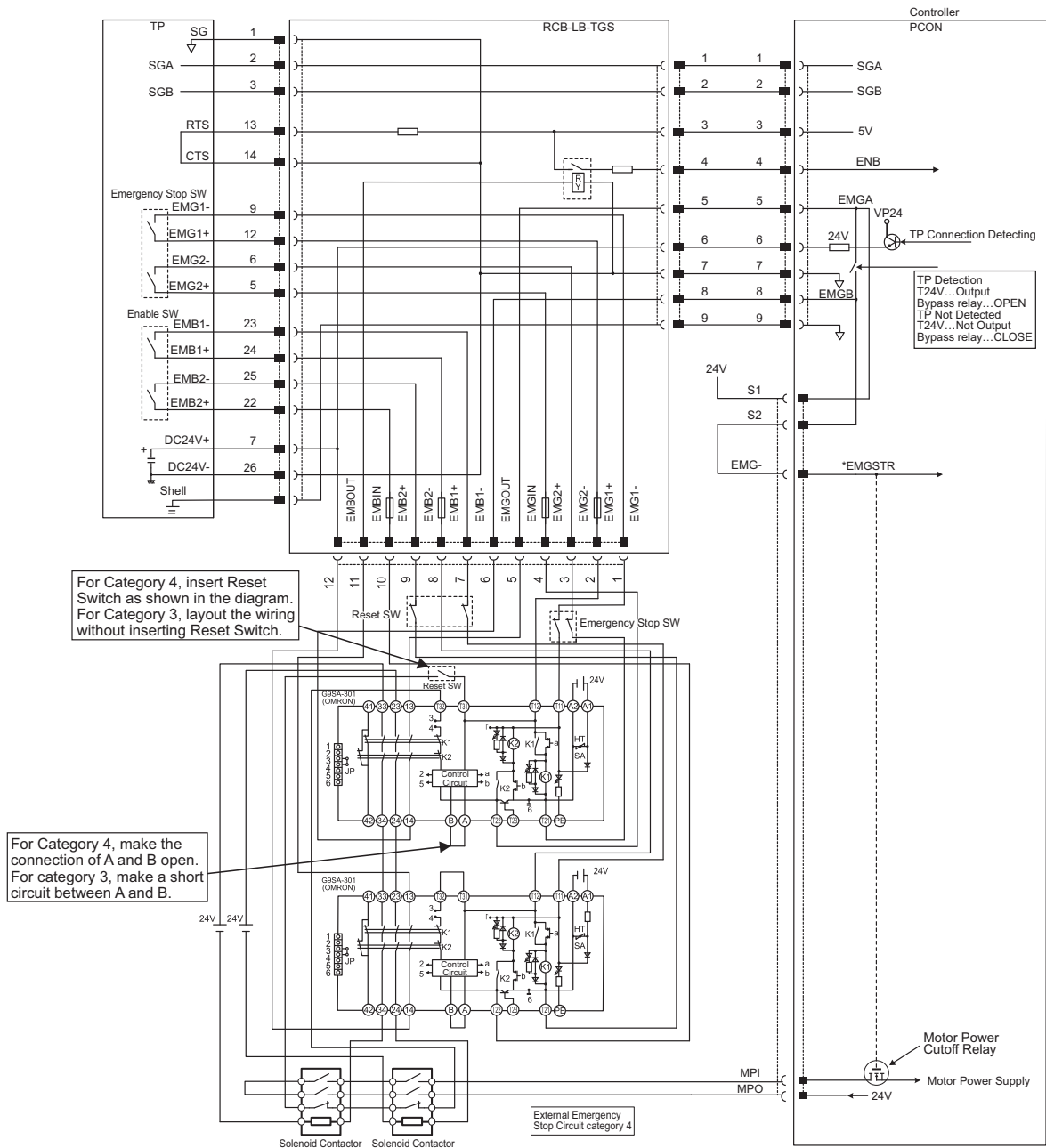

[4] TP Adapter and Accessories

1) TP adapter external dimensions

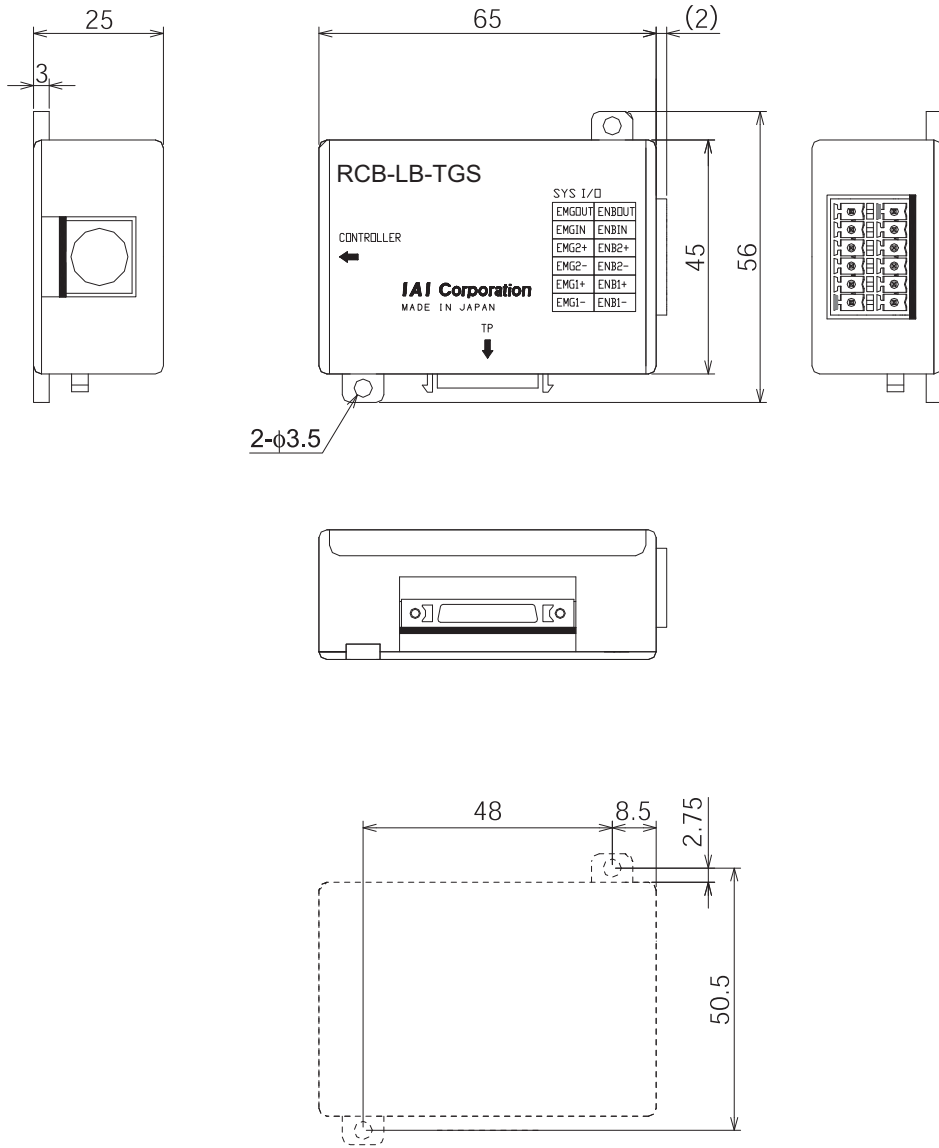

2) Connection Cable

- Controller/TP Adaptor Connection Cable

Use this cable to connect the controller and TP adaptor (RCB-LB-TG).

Model : CB-CON-LB005 (standard cable length : 0.5m)

Maximum cable length : 2.0m

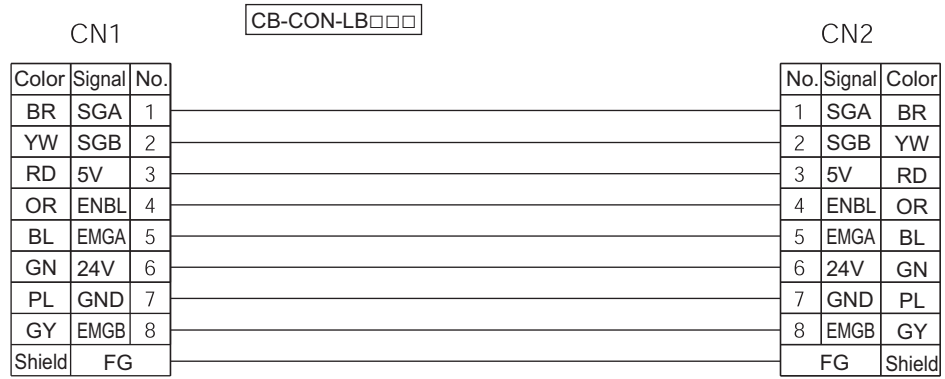

8PIN MIN DIN Connector (overmolded)

8PIN MIN DIN Connector (overmolded)

3) Dummy plug

Connect a dummy plug to the teaching pendant connecting connector.
 Make sure to connect a dummy plug if the AUTO mode is specified.
 Without the connection, it will be the emergency stop condition.
 Model : DP-4S

DP-4S



Plug : HDR-E26MAG1+

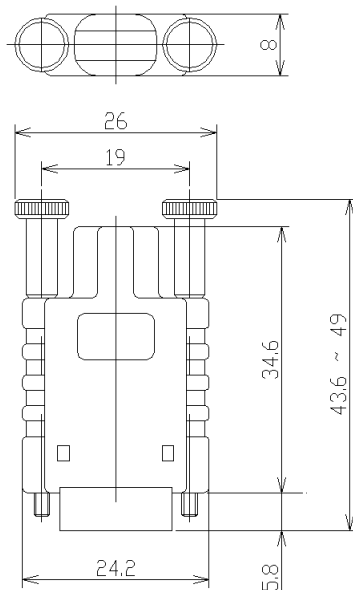

Signal	No.
GND	1
EMGS	2
VCC	3
DTR	4
EMGOUT2	5
EMGIN2	6
NC	7
RSVCC	8
EMGIN1	9
NC	10
NC	11
EMGOUT1	12
RTS	13
CTS (GND)	14
TXD	15
RXD	16
DSR	17
NC	18
NC	19
RSVTBX1	20
RSVTBX2	21
ENBVCC2	22
ENBTBX1	23
ENBVCC1	24
ENBTBX2	25
GND	26

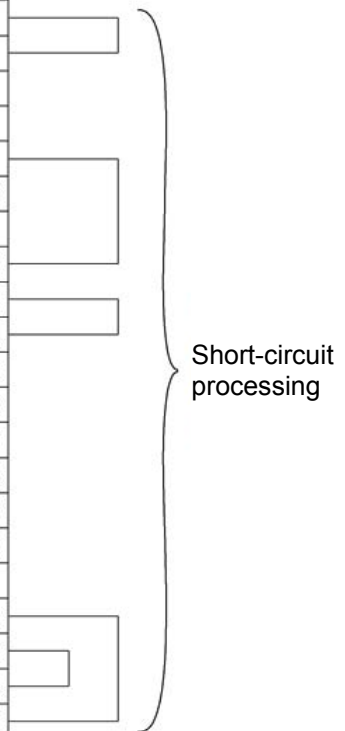

9.3 When Connecting Power Supply with + Grounding

When using with + grounding, there is a risk of short-circuit of 24V DC power supply if connected to the PC. This is because many PCs have the communication ground (GND) and the frame ground (FG) connected inside and short-circuit occurs through the frame ground. Also, if controllers with different 24V DC power supplies are connected with serial communication, the communication line may become the route of controller power supply in some cases depending on the timing to turn on the power, resulting in the malfunction of the communication line. Troubleshooting is summarized separately in [ME0271 Caution for + Grounding 24V Power Controller]. Please refer to it.

9.4 Maintenance

9.4.1 Consumed Parts

These parts below have production life. Shown below is the reference.

Item	Life	Specification
Electrolytic capacitor	5 years	0 to 40°C
Backup capacitor for calendar feature	5 years	When repeated to conduct for 12H in 40°C environment and cut for 12H in 20°C environment
Forced air-cooling FAN (CFB)	Approx. 3 years	When repeated to conduct for 24H in 40°C

9.4.2 Maintenance Information

The times of actuator run and distance of operation can be summed up and recorded ^(Note 1) in the controller. Also, a signal can be output ^(Note 2) externally when the times and distance exceed the threshold. By this signal, notice can be available for the timing of grease supply or regular inspection.

Note 1 The contents recorded by “PC Software” ^(Note 3), Modbus and Field Network ^(Note 4) can be checked.

Note 2 It is necessary to establish the settings in Parameter No.147 “Total movement count target value” and No.148 “Total operated distance target value”.

Note 3 Refer to the instruction manuals of RC PC Software for details.

Note 4 It is limited only to specific operation modes.

9.4.3 Replacement of Fan (PCON-CFB)

If an error is detected on the fan, replace the fan unit by following the process stated below.

[Procedure 1] Prepare a new fan unit and pull the fan unit desorption lever to release the lock.

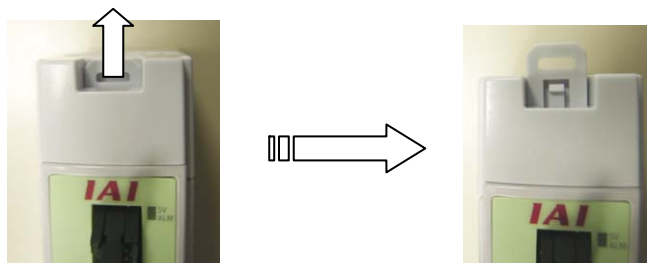

[Procedure 2] Pull out the fan unit to detach.

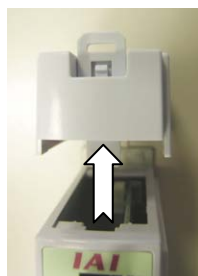

[Procedure 3] Attach a new fan unit considering the connector on the unit matches with the connector on the upper side of PCON-CFB.



[Procedure 4] Push in the fan unit desorption lever till it makes a click noise.



9.5 Example of Basic Positioning Sequence (PIO pattern 0 to 3)

This section shows an example in which a simple operation box directs PCON to move the actuator successively to three positions on an axis.

9.5.1 I/O Assignment

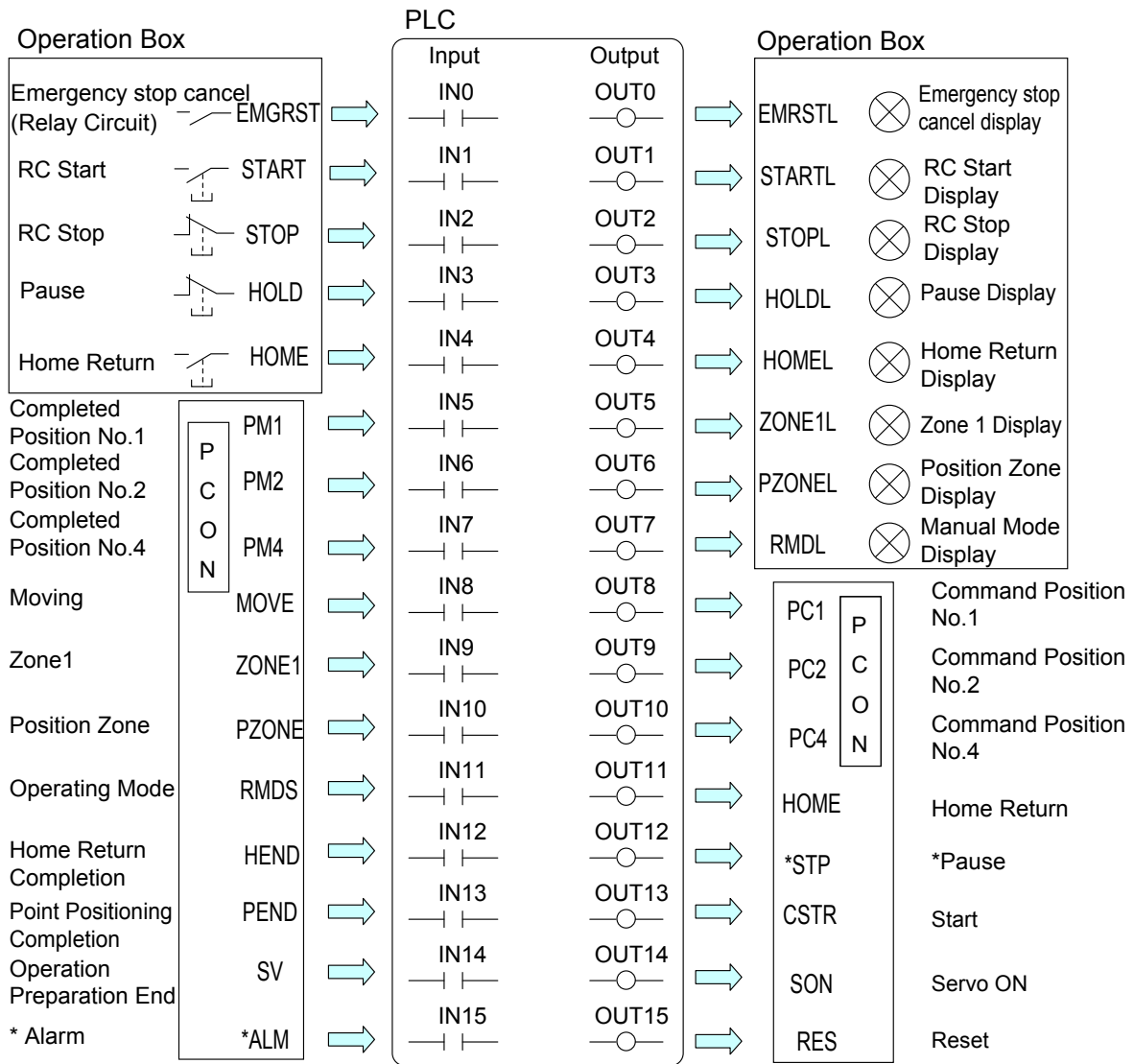

“*” in codes above shows the signal of the active low. Input signal is processed with it is turned OFF and output signal is usually ON when the power is supplied and is OFF when signal output.

9.5.2 Ladder Sequence

[1] Servo ON (Emergency Stop) Circuit

- 1) It is presumed that the emergency stop release circuit installed in the operation box possesses the self-retaining circuit as shown in "2.1.3 [1] Emergency Stop Circuit". When it comes to the emergency stop release condition, "Servo-on" signal from PLC to PCON turns ON.
- 2) Then if the emergency stop release state continues, the operation ready complete signal (sent from PCON to PLC) is turned on to go on the "Emergency stop release" lamp, which indicates that the actuator can be operated.

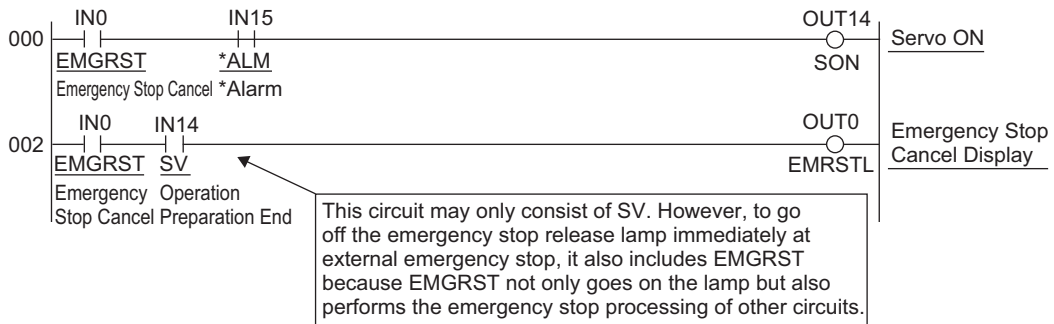

[2] Operation and Stop Circuit

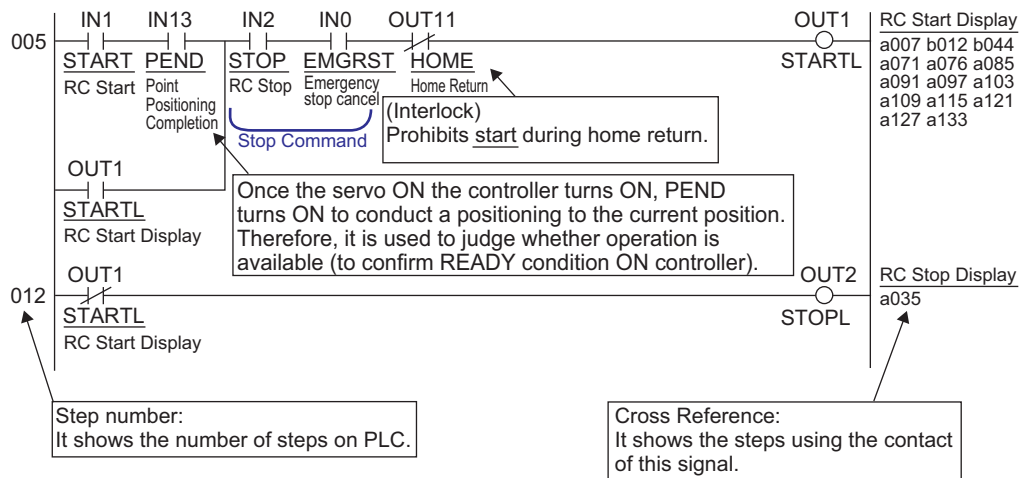

[3] Pause Circuit

Pause is provided by a single pushbutton. In a similar way as use of an alternate switch, push the button to make the actuator pause and push it again to release the pause of the actuator. Pushing the pushbutton leads the “pause command and pause lamp ON” state and pushing the pushbutton again brings “pause release command and pause lamp OFF”.

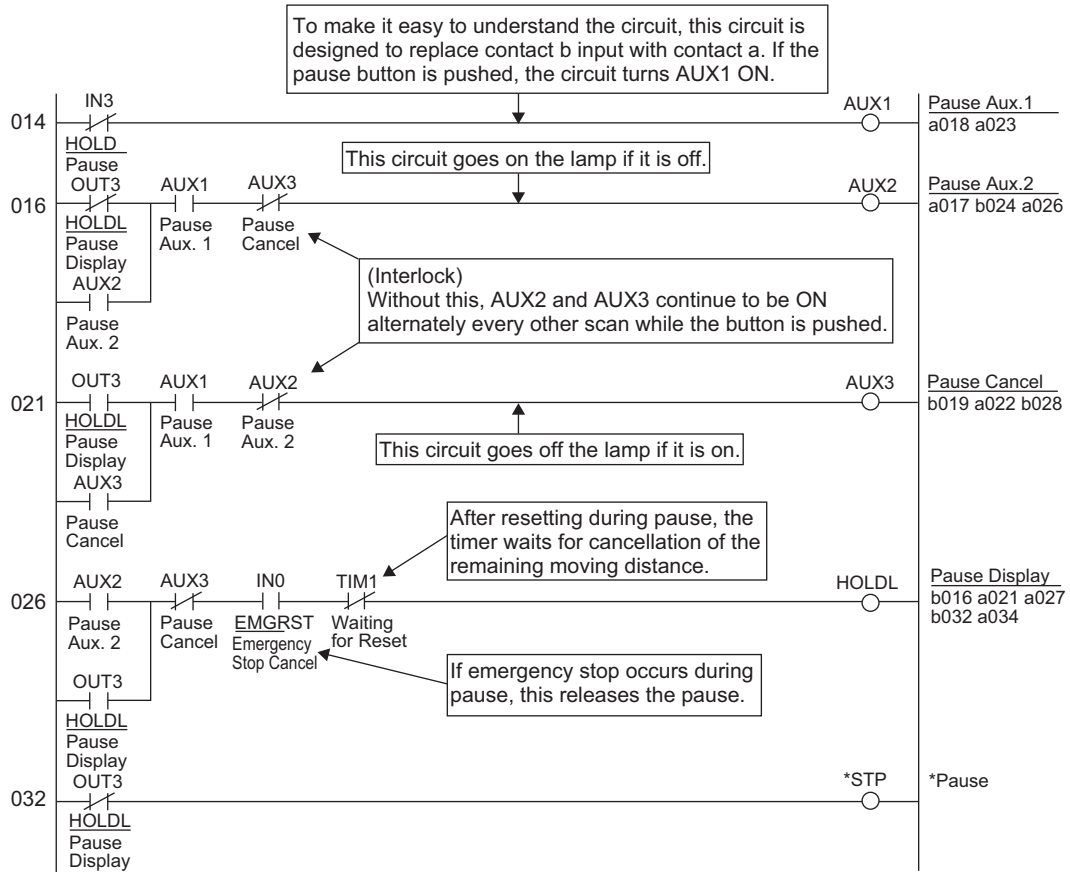

[4] Reset Circuit

If the "Stop" button on the operation box is pushed during pause, the "Reset" signal sent from PLC to PCON is turned ON and the remaining moving distance is cancelled. In addition, this operation releases the pause. (It is because the pause is not required with no remaining moving distance.)

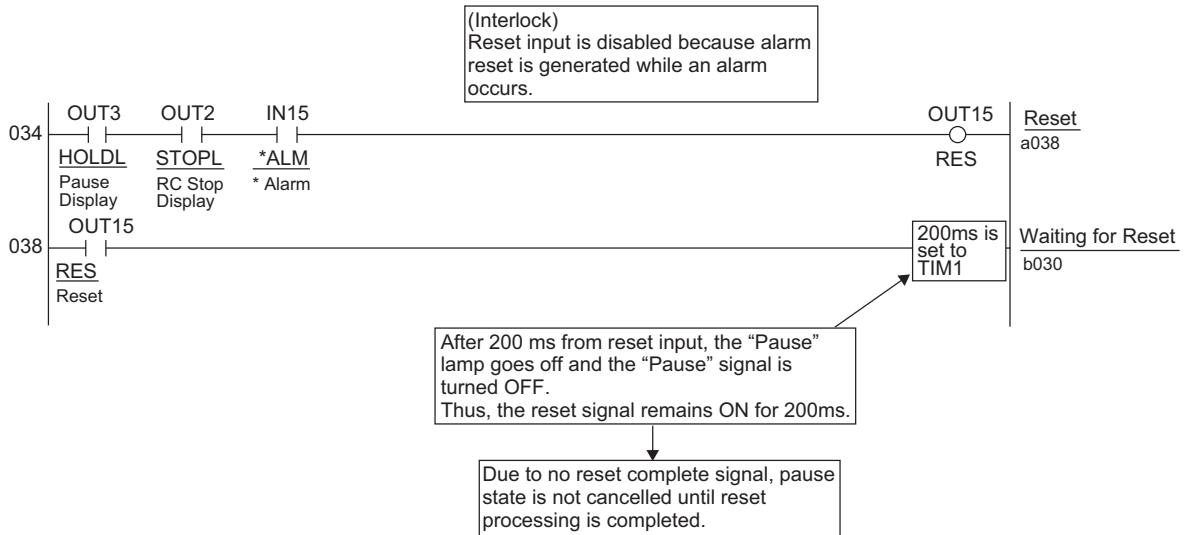

[5] Home Return Circuit

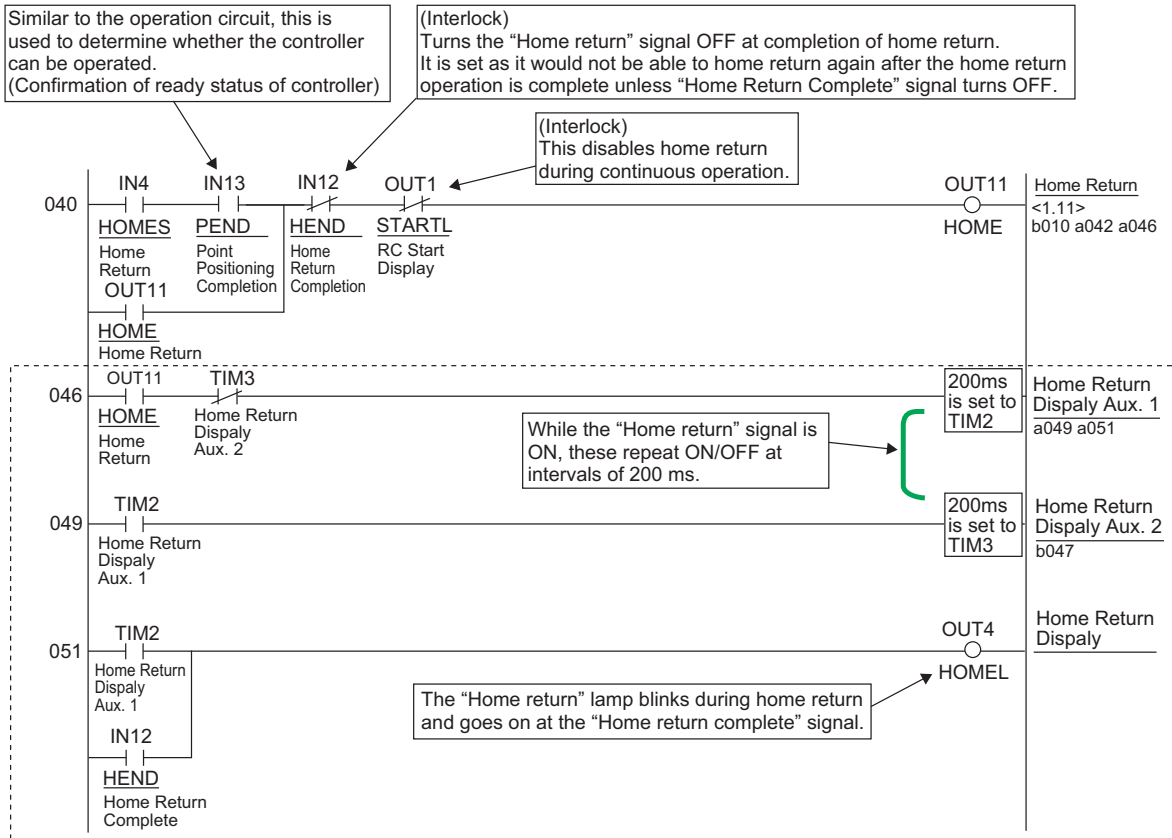

[6] Decode Circuit of Positioning Complete Position No.

The decode circuit converts the binary data of positioning complete position No. sent from PCON to PLC into the corresponding bit data.

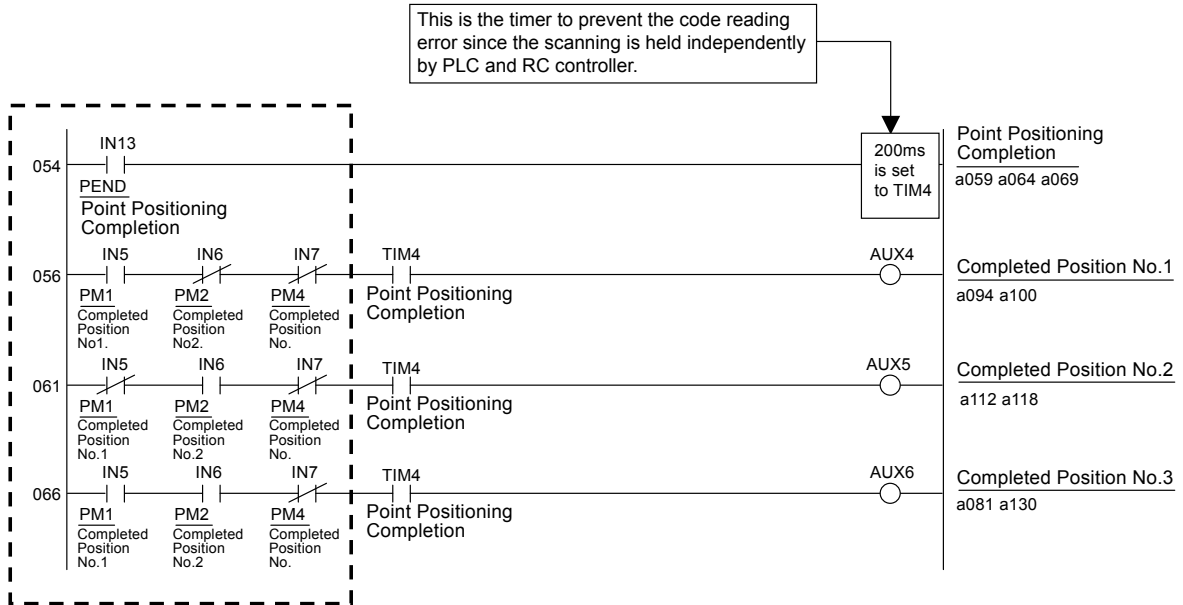

[7] Actuator Start Circuit

If the "Operation" switch on the operation box is pushed, the lamp of the "Operation" pushbutton switch described in [2] Operation and Stop Circuit goes on and, at the same time, the actuator starts successive positioning of position No. 1→2→3→1→2... The circuit below is intended for the activation.

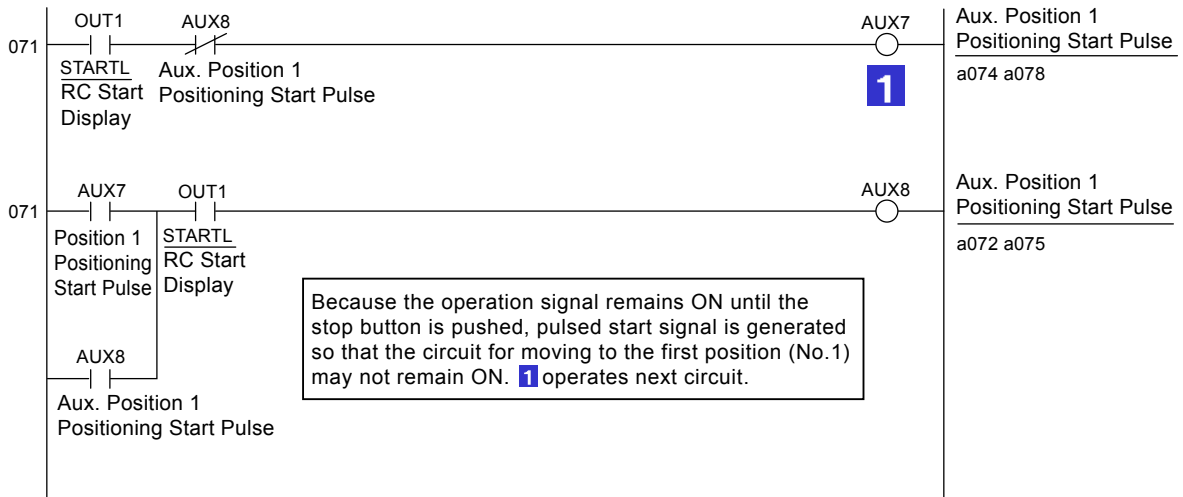

[8] Position 1 Operation Circuit

The main circuit is designed to process and manage signals “start” → “moving” → “positioning complete” to move the actuator to position No.1.

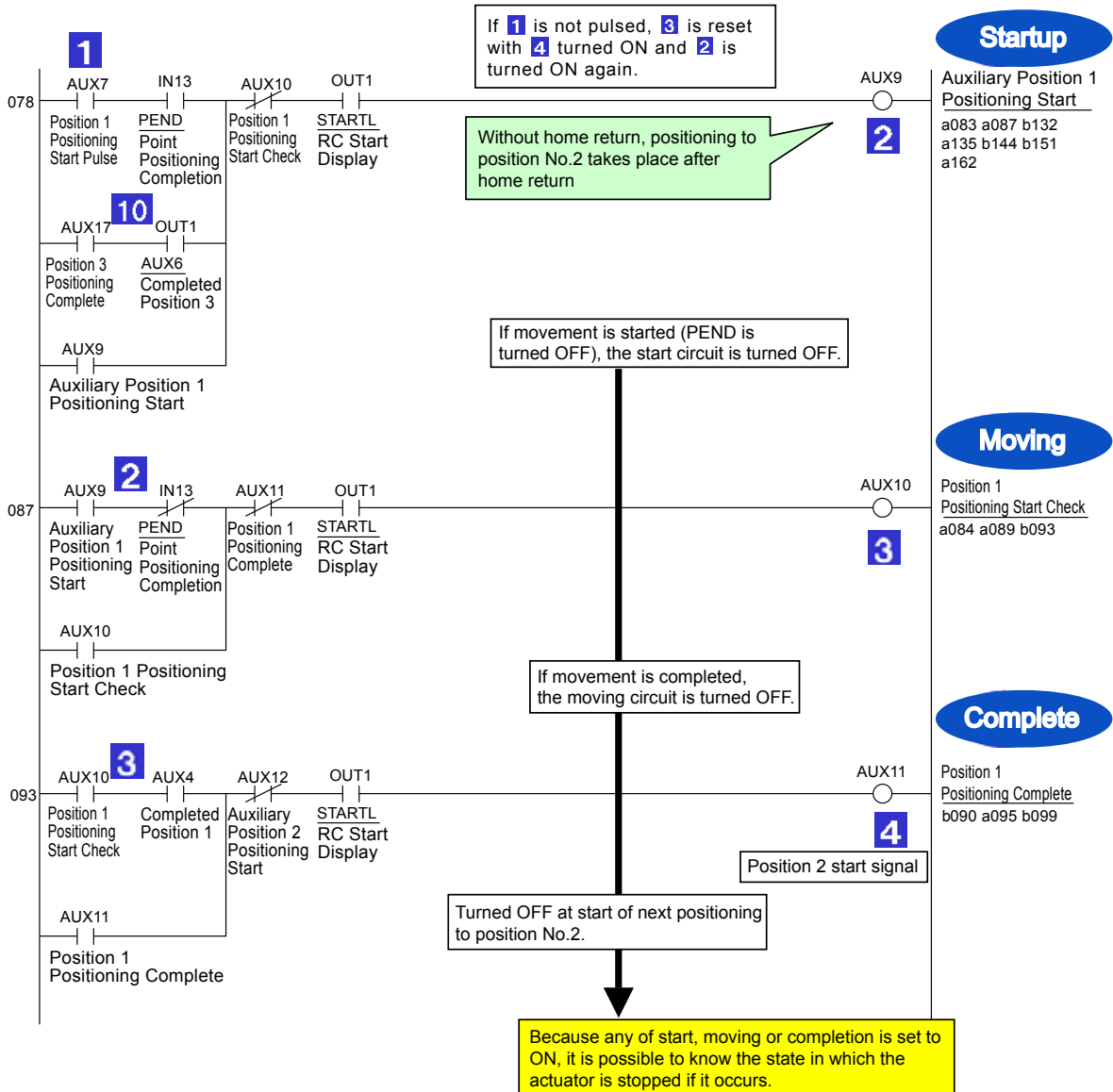

- Circuit 10 is designed to start positioning to position No.1 again after positioning to position No.3 is completed.
- If the “Operation” lamp goes off, the operation circuit is reset entirely. When the “Stop” button is pushed, the actuator will stop at completion of the operation being executed. At emergency stop, the actuator is stopped immediately (which is the function of PCON).

[9] Position 2 Operation Circuit

The main circuit is designed to process and manage signals “start” → “moving” → “positioning complete” to move the actuator to position No.2. This circuit indicates the same sequence as that of position No.1.

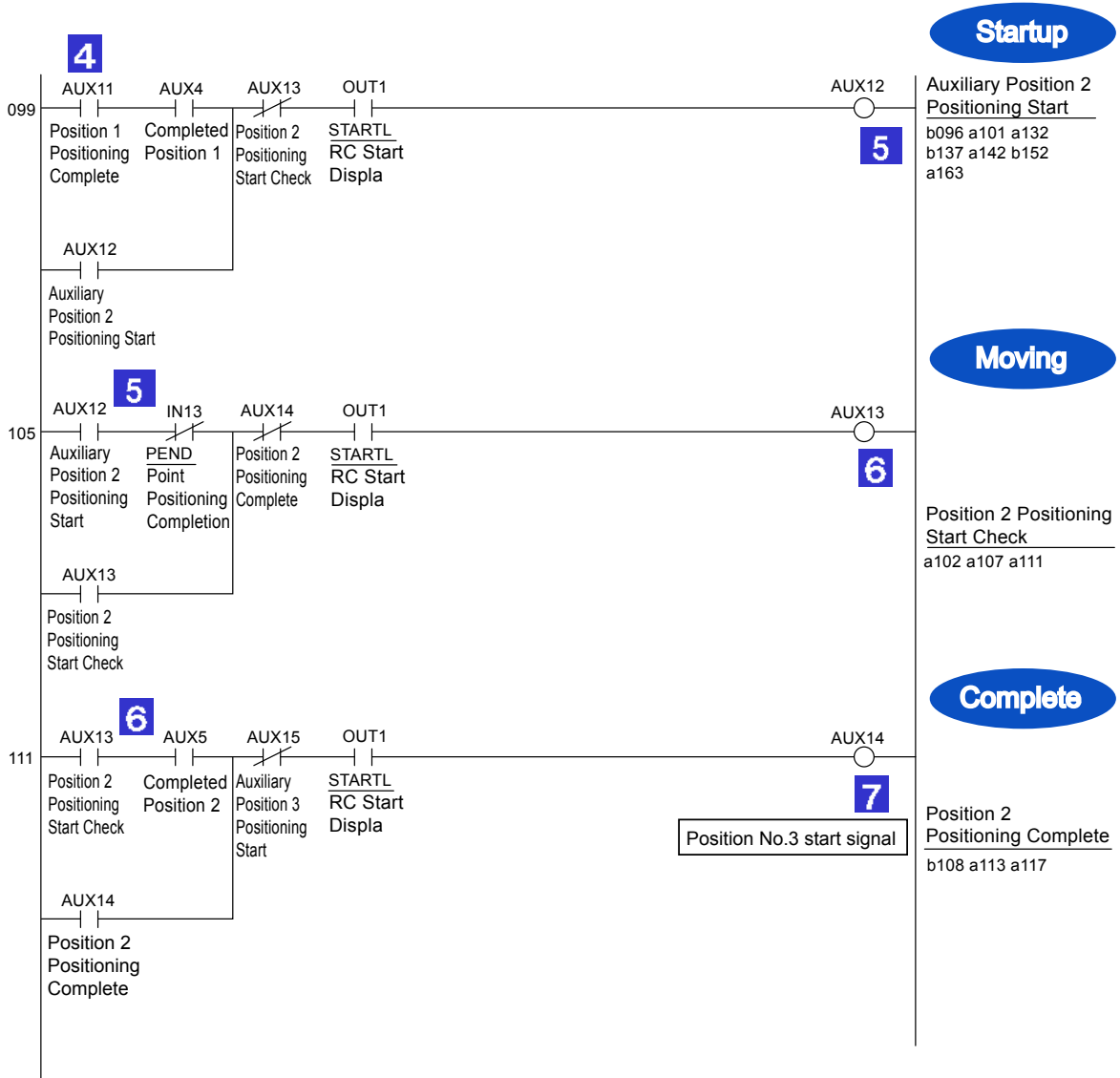

[10] Position 3 Operation Circuit

The main circuit is designed to process and manage signals “start” → “moving” → “positioning complete” to move the actuator to position No.3. This circuit indicates the same sequence as that of position No.1.

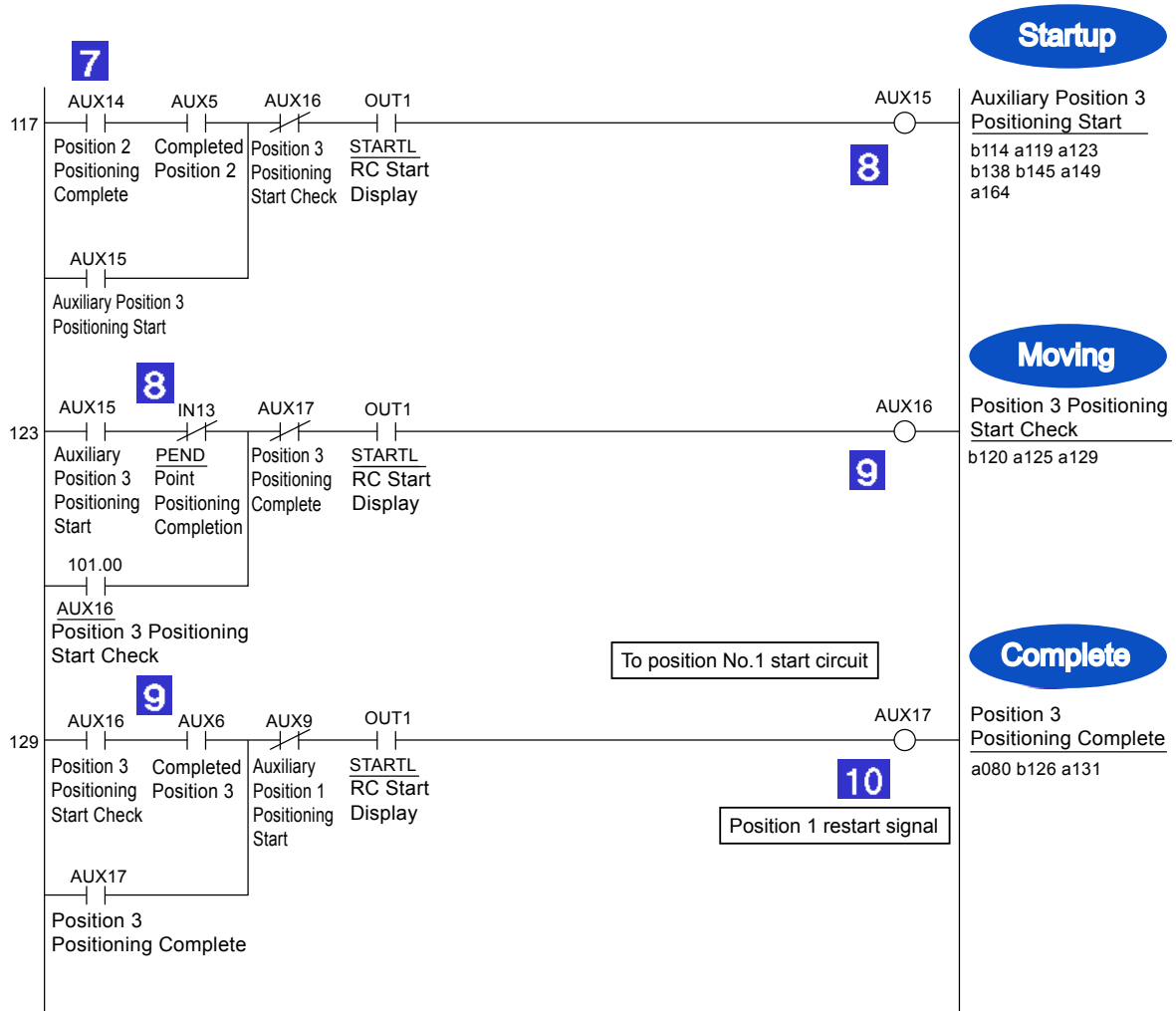

[11] Commanded Position No. Output Ready Circuit

The ready circuit is designed to hold start command and output commanded position No. in the binary code.

Interlock is taken so that position No. command may not be specified incorrectly.

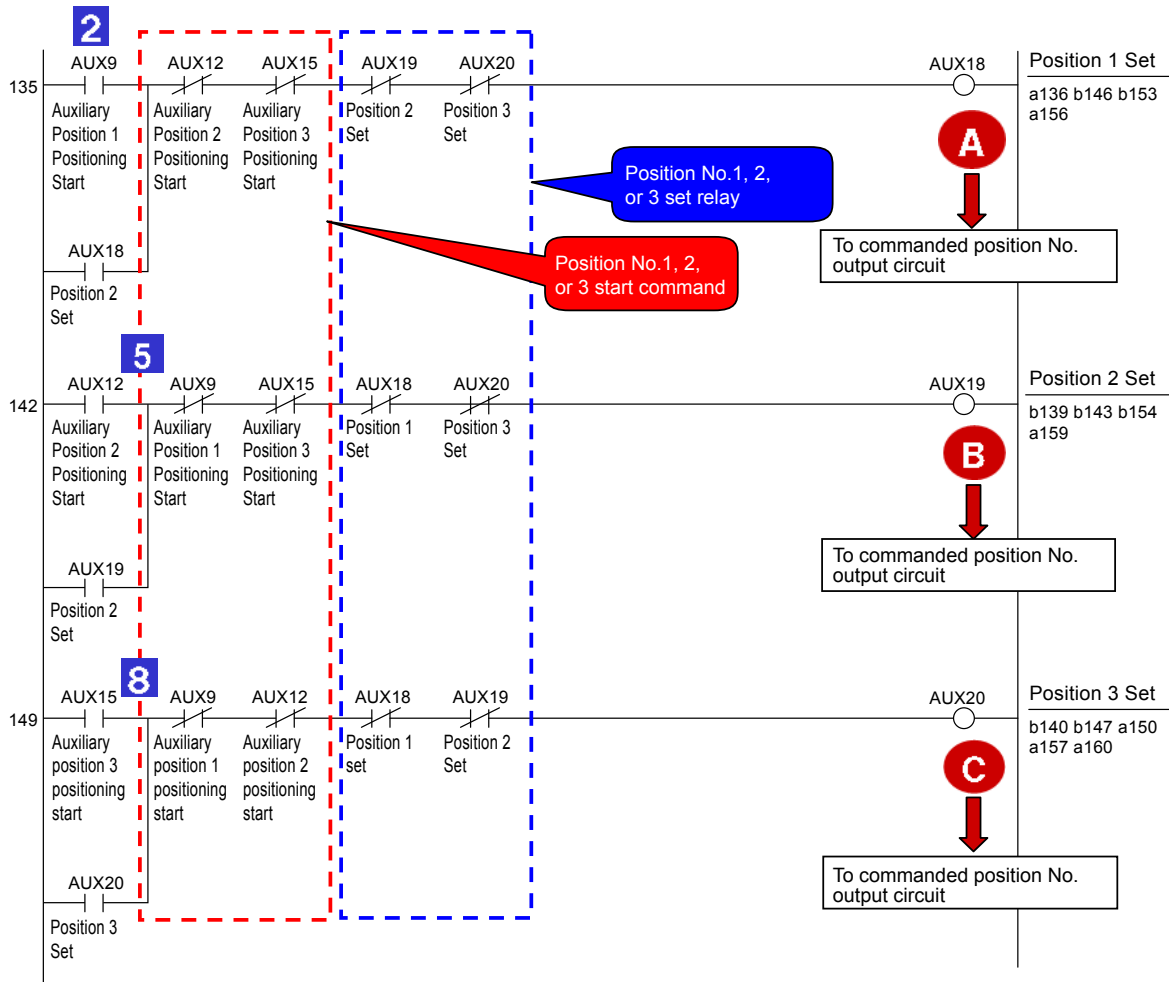

- Once a moving command to a position is issued, any of circuits A, B and C is turned ON to remember it unless a moving command to another position is issued. The operation circuit is cancelled by a stop command such as an emergency stop command. However, the circuit remembers the positions to which the actuator moved and the positions at which the actuator stopped until the cancellation. Such sequence design is also intended to cope with errors occurred and helpful to find the causes of the errors from circuit status, stop position inconsistency and other conditions.
- Taking interlock in both commands and results is usual means in circuit design to prevent results from being ON simultaneously. For example, if both SOLs in a solenoid valve of double SOL type are turned ON simultaneously, the coils are burned instantly. In another case, PLC executes a program in descending order but operations are not always done in the order. If you create a sequence program taking operation order into account, circuit change and/or addition due to debugging and specification change may cause the operation order to be modified without intention. Take interlock securely.

[12] Commanded Position No. Output Circuit

Depending on the result of the ready circuit, this circuit converts position No. to the binary code and outputs the data from PLC to PCON.

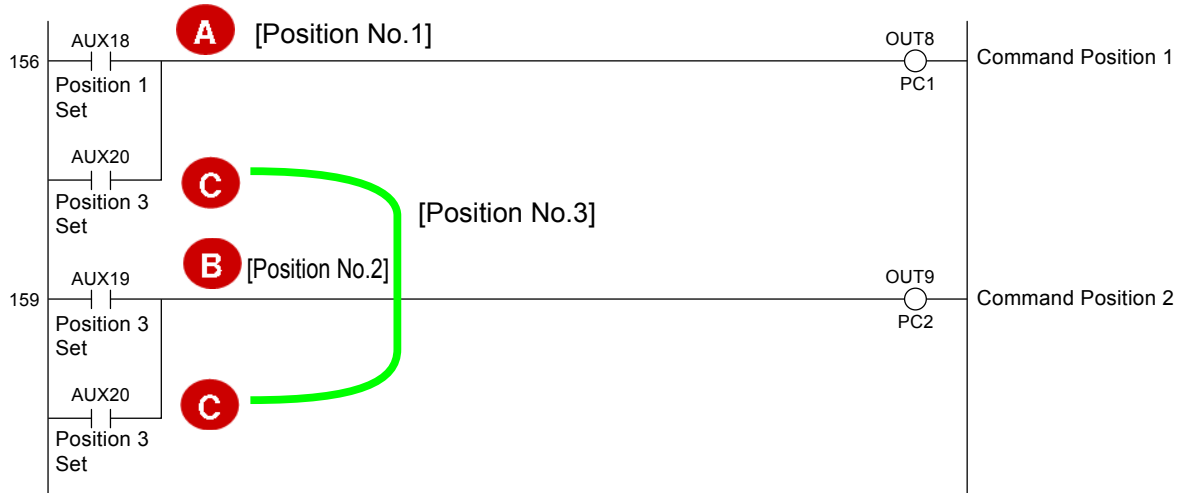

[13] Start Signal Output Circuit

After 20ms from the output of position No., this circuit outputs the start signal from PLC to PCON.

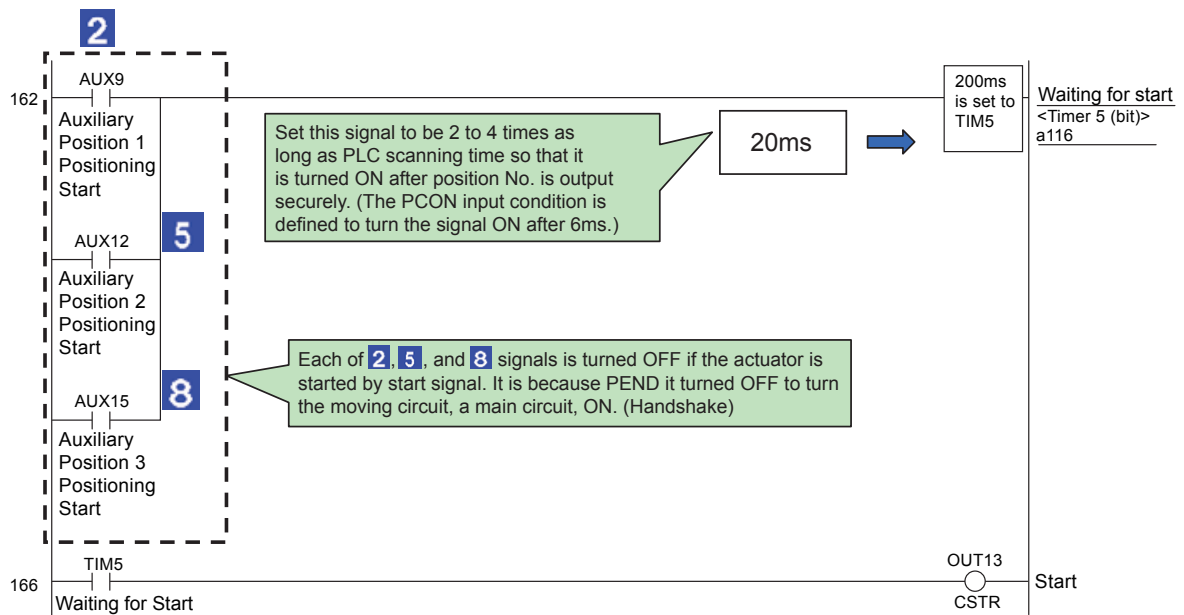

[14] Other Display Circuits (Zone 1, Position Zone, and Manual Mode)

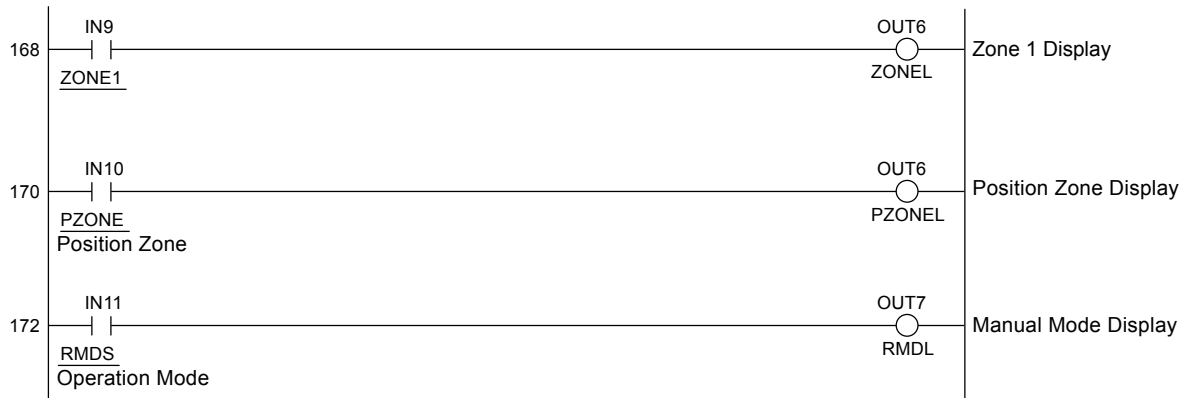

[Reference]

Programs and functions of PLC are expressed differently depending on manufacturers. However, the contents of sequence designs do not vary fundamentally. Though arithmetic and data processing commands seem differently, any manufacturer defines command words executing the same functions as those of other manufacturers.

9.6 List of Specifications of Connectable Actuators

The specifications included in this specification list are limited to those needed to set operating conditions and parameters. For other detailed specifications, refer to the catalog or operation manual for your actuator.



Caution

- The push force is based on the rated push speed (factory setting) indicated in the list, and provides only a guideline.
- Make sure the actual push force is equal to or greater than the minimum push force. If not, the push force will not stabilize.
- Do not change the setting of push speed (parameter No.34). If you must change the push speed, consult IAI.
- If, among the operating conditions, the positioning speed is set to a value equal to or smaller than the push speed, the push speed will become the set speed and the specified push force will not generate.
- When operation is conducted in the pulse train control, it is required to pay attention not to have the commands from the host controller for the movement amount, velocity and acceleration/deceleration exceed the actuator specifications (for stroke, maximum velocity, maximum acceleration/deceleration). Also, make sure to set the pressing operation velocity to the rated pressing velocity when the pressing operation is to be conducted. Use in higher than the specifications could cause an error or malfunction.

9.6.1 Specifications for Actuators

RCP6 Series

Actuator series	Type	Feed screw	No. of encoder pulses	Lead [mm]	Mounting direction	Minimum speed [mm/s]	Maximum speed [mm/s]	Maximum acceleration /deceleration [G]	Minimum push force [N]	Maximum push force [N]	Rated push speed [mm/s]
RCP6 RCP6CR (Slider type) Standard type / Cleanroom type	[Standard] SA4C SA4R	Ball screw	8192	16	Horizontal	20	1260 (at 50 to 400st) 1060 (at 450st) 875 (at 500st)	1	21	48	20
					Vertical		SA4C: 1260 (at 50 to 400st) 1060 (at 450st) 875 (at 500st)	0.5			
	SA4R: 1120 (at 50 to 400st) 1060 (at 450st) 875 (at 500st)										
					[Cleanroom] SA4C		10	Horizontal			
	Vertical			0.5							
	5			Horizontal	7	390 (at 50 to 400st) 330 (at 450st) 275 (at 500st)	1	44	155		
				Vertical		0.5					
	2.5			Horizontal	4	195 (at 50 to 400st) 165 (at 450st) 135 (at 500st)	1	89	310		
Vertical		0.5									

Note The values of the maximum velocity and maximum acceleration/deceleration for RCP6/RCP6CR/RCP6W are the ones when the high-output feature is activated. (There are also some models that are not related to the high-output setting.)

RCP6 Series

Actuator series	Type	Feed screw	No. of encoder pulses	Lead [mm]	Mounting direction	Minimum speed [mm/s]	Maximum speed [mm/s]	Maximum acceleration /deceleration [G]	Minimum push force [N]	Maximum push force [N]	Rated push speed [mm/s]
RCP6 RCP6CR (Slider type) Standard type / Cleanroom type	[Standard] SA6C SA6R	Ball screw	8192	20	Horizontal	25	SA6C: 1440 (at 50 to 450st) 1335 (at 500st) 1130 (at 550st) 970 (at 600st) 840 (at 650st) 735 (at 700st) 650 (at 750st) 575 (at 800st) SA6R: 1280 (at 50 to 500st) 1130 (at 550st) 970 (at 600st) 840 (at 650st) 735 (at 700st) 650 (at 750st) 575 (at 800st)	1	16	56	20
					Vertical		SA6C: 1280 (at 50 to 500st) 1130 (at 550st) 970 (at 600st) 840 (at 650st) 735 (at 700st) 650 (at 750st) 575 (at 800st) SA6R: 1120 (at 50 to 550st) 970 (at 600st) 840 (at 650st) 735 (at 700st) 650 (at 750st) 575 (at 800st)				
	[Cleanroom] SA6C			12	Horizontal	15	SA6C: 900 (at 50 to 400st) 885 (at 450st) 735 (at 500st) 620 (at 550st) 535 (at 600st) 460 (at 650st) 405 (at 700st) 355 (at 750st) 315 (at 800st)	1	27	93	
					Vertical		SA6C: 900 (at 50 to 400st) 885 (at 450st) 735 (at 500st) 620 (at 550st) 535 (at 600st) 460 (at 650st) 405 (at 700st) 355 (at 750st) 315 (at 800st) SA6R: 800 (at 50 to 450st) 735 (at 500st) 620 (at 550st) 535 (at 600st) 460 (at 650st) 405 (at 700st) 355 (at 750st) 315 (at 800st)				

Note The values of the maximum velocity and maximum acceleration/deceleration for RCP6/RCP6CR/RCP6W are the ones when the high-output feature is activated. (There are also some models that are not related to the high-output setting.)

RCP6 Series

Actuator series	Type	Feed screw	No. of encoder pulses	Lead [mm]	Mounting direction	Minimum speed [mm/s]	Maximum speed [mm/s]	Maximum acceleration /deceleration [G]	Minimum push force [N]	Maximum push force [N]	Rated push speed [mm/s]
RCP6 RCP6CR (Slider type) Standard type / Cleanroom type	[Standard] SA6C SA6R [Cleanroom] SA6C	Ball screw	8192	6	Horizontal	8	450 (at 50 to 400st) 435 (at 450st) 365 (at 500st) 305 (at 550st) 265 (at 600st) 230 (at 650st) 200 (at 700st) 175 (at 750st) 155 (at 800st)	1	53	185	20
					Vertical		0.5				
				3	Horizontal	4	225 (at 50 to 400st) 215 (at 450st) 180 (at 500st) 150 (at 550st) 130 (at 600st) 115 (at 650st) 100 (at 700st) 85 (at 750st) 75 (at 800st)	1	106	370	
					Vertical		0.5				
				24	Horizontal	30	SA7C: 1200 (at 50 to 600st) 1095 (at 650st) 965 (at 700st) 850 (at 750st) 760 (at 800st) SA7R: 1080 (at 50 to 650st) 965 (at 700st) 850 (at 750st) 760 (at 800st)	1	40	139	
					Vertical		0.5				
	[Standard] SA7C SA7R [Cleanroom] SA7C	Ball screw	8192	16	Horizontal	20	SA7C: 980 (at 50 to 500st) 965 (at 550st) 830 (at 600st) 720 (at 650st) 635 (at 700st) 560 (at 750st) 500 (at 800st) SA7R: 840 (at 50 to 550st) 830 (at 600st) 720 (at 650st) 635 (at 700st) 560 (at 750st) 500 (at 800st)	1	60	209	
							Vertical	0.5			
		Ball screw	8192	16	Horizontal	20	SA7C: 840 (at 50 to 550st) 830 (at 600st) 720 (at 650st) 635 (at 700st) 560 (at 750st) 500 (at 800st) SA7R: 700 (at 50 to 650st) 635 (at 700st) 560 (at 750st) 500 (at 800st)	0.5	60	209	
							Vertical	0.5			

Note The values of the maximum velocity and maximum acceleration/deceleration for RCP6/RCP6CR/RCP6W are the ones when the high-output feature is activated. (There are also some models that are not related to the high-output setting.)

RCP6 Series

Actuator series	Type	Feed screw	No. of encoder pulses	Lead [mm]	Mounting direction	Minimum speed [mm/s]	Maximum speed [mm/s]	Maximum acceleration /deceleration [G]	Minimum push force [N]	Maximum push force [N]	Rated push speed [mm/s]
RCP6 RCP6CR (Slider type) Standard type / Cleanroom type	[Standard] SA7C SA7R	Ball screw	8192	8	Horizontal	10	SA7C: 490 (at 50 to 500st) 475 (at 550st) 410 (at 600st) 355 (at 650st) 315 (at 700st) 275 (at 750st) 245 (at 800st)	1	119	418	20
					Vertical		SA7R: 420 (at 50 to 550st) 410 (at 600st) 355 (at 650st) 315 (at 700st) 275 (at 750st) 245 (at 800st)				
	[Cleanroom] SA7C	Ball screw	8192	4	Horizontal	5	SA7C: 245 (at 50 to 500st) 235 (at 550st) 205 (at 600st) 175 (at 650st) 155 (at 700st) 135 (at 750st) 120 (at 800st)	1	239	836	
							Vertical				
	[Standard] SA8C SA8R	Ball screw	8192	30	Horizontal	38	1200 (at 50 to 750st) 1155 (at 800st) 1040 (at 850st) 940 (at 900st) 855 (at 950st) 780 (at 1000st) 715 (at 1050st) 660 (at 1100st)	1	46	159	
					Vertical		850 (at 50 to 950st) 780 (at 1000st) 715 (at 1050st) 660 (at 1100st)				
[Cleanroom] SA8C				20	Horizontal	25	1000 (at 50 to 650st) 950 (at 700st) 860 (at 750st) 770 (at 800st) 695 (at 850st) 630 (at 900st) 570 (at 950st) 520 (at 1000st) 480 (at 1050st) 440 (at 1100st)	1	68	239	

Note The values of the maximum velocity and maximum acceleration/deceleration for RCP6/RCP6CR/RCP6W are the ones when the high-output feature is activated. (There are also some models that are not related to the high-output setting.)

RCP6 Series

Actuator series	Type	Feed screw	No. of encoder pulses	Lead [mm]	Mounting direction	Minimum speed [mm/s]	Maximum speed [mm/s]	Maximum acceleration /deceleration [G]	Minimum push force [N]	Maximum push force [N]	Rated push speed [mm/s]
RCP6 RCP6CR (Slider type) Standard type / Cleanroom type	[Standard] SA8C SA8R [Cleanroom] SA8C	Ball screw	8192	20	Vertical	25	800 (at 50 to 750st) 770 (at 800st) 695 (at 850st) 630 (at 900st) 570 (at 950st) 520 (at 1000st) 480 (at 1050st) 440 (at 1100st)	0.5	68	239	20
							10				
				5	Vertical	7		SA8C: 250 (at 50 to 650st) 240 (at 700st) 215 (at 750st) 190 (at 800st) 175 (at 850st) 155 (at 900st) 140 (at 950st) 130 (at 1000st) 120 (at 1050st) 110 (at 1100st)	1	273	
					5		Horizontal	7			
				16		Horizontal	20		840 (at 50 to 400st) 775 (at 450st) 660 (at 500st)	1	
					10			Horizontal	13		
5	Horizontal	7	390 (at 50 to 300st) 355 (at 350st) 290 (at 400st) 245 (at 450st) 205 (at 500st)	1		44	155				

Note The values of the maximum velocity and maximum acceleration/deceleration for RCP6/RCP6CR/RCP6W are the ones when the high-output feature is activated. (There are also some models that are not related to the high-output setting.)

RCP6 Series

Actuator series	Type	Feed screw	No. of encoder pulses	Lead [mm]	Mounting direction	Minimum speed [mm/s]	Maximum speed [mm/s]	Maximum acceleration /deceleration [G]	Minimum push force [N]	Maximum push force [N]	Rated push speed [mm/s]
RCP6 RCP6CR (Wide slider type) Standard type / Cleanroom type	[Standard] WSA10C WSA10R [Cleanroom] WSA10C	Ball screw	8192	5	Vertical	7	WSA10C: 350 (at 50 to 350st) 290 (at 400st) 245 (at 450st) 205 (at 500st)	0.5	44	155	20
							WSA10R: 305 (at 50 to 350st) 290 (at 400st) 245 (at 450st) 205 (at 500st)				
				2.5	Horizontal	4	195 (at 50 to 300st) 175 (at 350st) 145 (at 400st) 120 (at 450st) 100 (at 500st)	1	89	310	
							Vertical				
	[Standard] WSA12C WSA12R [Cleanroom] WSA12C	Ball screw	8192	20	Horizontal	25	800 (at 50 to 600st) 740 (at 650st) 650 (at 700st) 580 (at 750st) 520 (at 800st)	1	16	56	20
							12				
				6	Horizontal	8		450 (at 50 to 350st) 435 (at 400st) 365 (at 450st) 310 (at 500st) 265 (at 550st) 230 (at 600st) 200 (at 650st) 175 (at 700st) 155 (at 750st) 140 (at 800st)	1	53	
							Vertical	400 (at 50 to 400st) 365 (at 450st) 310 (at 500st) 265 (at 550st) 230 (at 600st) 200 (at 650st) 175 (at 700st) 155 (at 750st) 140 (at 800st)			
				3	Horizontal	4		225 (at 50 to 350st) 215 (at 400st) 180 (at 450st) 150 (at 500st) 130 (at 550st) 115 (at 600st) 100 (at 650st) 85 (at 700st) 75 (at 750st) 70 (at 800st)	1	106	
							Vertical	225 (at 50 to 350st) 215 (at 400st) 180 (at 450st) 150 (at 500st) 130 (at 550st) 115 (at 600st) 100 (at 650st) 85 (at 700st) 75 (at 750st) 70 (at 800st)	0.5		

Note The values of the maximum velocity and maximum acceleration/deceleration for RCP6/RCP6CR/RCP6W are the ones when the high-output feature is activated. (There are also some models that are not related to the high-output setting.)

RCP6 Series

Actuator series	Type	Feed screw	No. of encoder pulses	Lead [mm]	Mounting direction	Minimum speed [mm/s]	Maximum speed [mm/s]	Maximum acceleration /deceleration [G]	Minimum push force [N]	Maximum push force [N]	Rated push speed [mm/s]				
RCP6 RCP6CR (Wide slider type) Standard type / Cleanroom type	[Standard] WSA14C WSA14R [Cleanroom] WSA14C	Ball screw	8192	24	Horizontal	30	700 (at 50 to 750st) 665 (at 800st)	1	40	139	20				
				16	Horizontal	20	560 (at 50 to 650st) 550 (at 700st) 490 (at 750st) 440 (at 800st)	1	60	209					
				8	Horizontal	10	420 (at 50 to 500st) 400 (at 550st) 350 (at 600st) 305 (at 650st) 270 (at 700st) 240 (at 750st) 215 (at 800st)	1	119	418					
					Vertical		350 (at 50 to 600st) 305 (at 650st) 270 (at 700st) 240 (at 750st) 215 (at 800st)	0.5							
				4	Horizontal	5	WSA14C: 210 (at 50 to 500st) 200 (at 550st) 170 (at 600st) 150 (at 650st) 135 (at 700st) 120 (at 750st) 105 (at 800st) WSA14R: 175 (at 50 to 550st) 170 (at 600st) 150 (at 650st) 135 (at 700st) 120 (at 750st) 105 (at 800st)	1	239	836					
					Vertical		175 (at 50 to 550st) 170 (at 600st) 150 (at 650st) 135 (at 700st) 120 (at 750st) 105 (at 800st)	0.5							
				[Standard] [Cleanroom] WSA16C	Ball screw	8192	20	Horizontal	25	720 (at 50 to 750st) 715 (at 800st) 645 (at 850st) 590 (at 900st) 535 (at 950st) 490 (at 1000st) 450 (at 1050st) 415 (at 1100st)		1	68	239	20
										10					
							Vertical	240 (at 50 to 1000st) 225 (at 1050st) 205 (at 1100st)	0.5						

Note The values of the maximum velocity and maximum acceleration/deceleration for RCP6/RCP6CR/RCP6W are the ones when the high-output feature is activated. (There are also some models that are not related to the high-output setting.)

RCP6 Series

Actuator series	Type	Feed screw	No. of encoder pulses	Lead [mm]	Mounting direction	Minimum speed [mm/s]	Maximum speed [mm/s]	Maximum acceleration /deceleration [G]	Minimum push force [N]	Maximum push force [N]	Rated push speed [mm/s]
RCP6 RCP6CR (Wide slider type) Standard type / Cleanroom type	[Standard] [Cleanroom] WSA16C	Ball screw	8192	5	Horizontal	7	195 (at 50 to 750st) 175 (at 800st) 160 (at 850st) 145 (at 900st) 130 (at 950st) 120 (at 1000st) 110 (at 1050st) 100 (at 1100st)	1	273	956	20
					Vertical		170 (at 50 to 800st) 160 (at 850st) 145 (at 900st) 130 (at 950st) 120 (at 1000st) 110 (at 1050st) 100 (at 1100st)	0.5			
RCP6 (Wide slider type)	[Standard] WSA16R	Ball screw	8192	20	Horizontal	25	600 (at 50 to 850st) 590 (at 900st) 535 (at 950st) 490 (at 1000st) 450 (at 1050st) 415 (at 1100st)	1	68	239	20
					Vertical		365 (at 50 to 750st) 355 (at 800st) 320 (at 850st) 290 (at 900st) 265 (at 950st) 240 (at 1000st) 225 (at 1050st) 205 (at 1100st)	1			
				10	Horizontal	13	210 (at 50 to 1050st) 205 (at 1100st)	0.5	137	478	
					Vertical		170 (at 50 to 800st) 160 (at 850st) 145 (at 900st) 130 (at 950st) 120 (at 1000st) 110 (at 1050st) 100 (at 1100st)	1			
				5	Horizontal	7	145 (at 50 to 900st) 130 (at 950st) 120 (at 1000st) 110 (at 1050st) 100 (at 1100st)	0.5	273	956	
					Vertical		145 (at 50 to 900st) 130 (at 950st) 120 (at 1000st) 110 (at 1050st) 100 (at 1100st)	0.5			

Note The values of the maximum velocity and maximum acceleration/deceleration for RCP6/RCP6CR/RCP6W are the ones when the high-output feature is activated. (There are also some models that are not related to the high-output setting.)

RCP6 Series

Actuator series	Type	Feed screw	No. of encoder pulses	Lead [mm]	Mounting direction	Minimum speed [mm/s]	Maximum speed [mm/s]	Maximum acceleration /deceleration [G]	Minimum push force [N]	Maximum push force [N]	Rated push speed [mm/s]
RCP6 (Rod type)	RA4C RA4R	Ball screw	8192	16	Horizontal	20	840	1	21	48	20
					Vertical			0.5			
				10	Horizontal	13	RA4C: 700 RA4R: 610	1	22	77	
					Vertical			0.5			
				5	Horizontal	7	350	1	44	155	
					Vertical			0.5			
				2.5	Horizontal	4	175	1	88	310	
					Vertical			0.5			
	RA6C RA6R	Ball screw	8192	20	Horizontal	25	800	1	16	56	
					Vertical			0.5			
				12	Horizontal	15	700	1	26	93	
					Vertical			0.5			
				6	Horizontal	8	450	1	53	185	
					Vertical			0.5			
				3	Horizontal	4	225	1	106	370	
					Vertical			0.5			
	RA7C RA7R	Ball screw	8192	24	Horizontal	30	RA7C: 860 RA7R: 800	1	52	182	
					Vertical		640	0.5			
				16	Horizontal	20	RA7C: 700 RA7R: 560	1	78	273	
					Vertical		560	0.5			
				8	Horizontal	10	420	1	156	547	
					Vertical		350	0.5			
				4	Horizontal	5	RA7C: 210 RA7R: 175	1	312	1094	
					Vertical		175	0.5			
RA8C RA8R	Ball screw	8192	20	Horizontal	25	RA8C: 600 RA8R: 400	0.2	167	500		
				Vertical		RA8C: 450 RA8R: 400					
			10	Horizontal	13	RA8C: 300 RA8R: 200	0.2	333	1000		
				Vertical		RA8C: 250 RA8R: 200					
			5	Horizontal	7	RA8C: 150 RA8R: 100	0.1	667	2000		
				Vertical							
RCP6 (Radial cylinder)	RRA4C RRA4R	Ball screw	8192	16	Horizontal	20	RRA4C: 1120 (at 60 to 360st) 1080 (at 410st)	1	21	48	
					Vertical		RRA4R: 840	0.5			
				10	Horizontal	13	RRA4C: 700 (at 60 to 360st) 685 (at 410st)	1	22	77	
					Vertical		RRA4R: 610	0.5			
				5	Horizontal	7	350 (at 60 to 360st) 340 (at 410st)	1	44	155	
					Vertical			0.5			
				2.5	Horizontal	4	175 (at 60 to 360st) 170 (at 410st)	1	89	310	
					Vertical			0.5			

Note The values of the maximum velocity and maximum acceleration/deceleration for RCP6/RCP6CR/RCP6W are the ones when the high-output feature is activated. (There are also some models that are not related to the high-output setting.)

RCP6 Series

Actuator series	Type	Feed screw	No. of encoder pulses	Lead [mm]	Mounting direction	Minimum speed [mm/s]	Maximum speed [mm/s]	Maximum acceleration /deceleration [G]	Minimum push force [N]	Maximum push force [N]	Rated push speed [mm/s]			
RCP6 (Radial cylinder)	RRA6C RRA6R	Ball screw	8192	20	Horizontal	25	800	1	16	56	20			
					Vertical			0.5						
				12	Horizontal	15	700	1	26	93				
					Vertical			0.5						
				6	Horizontal	8	450	1	53	185				
					Vertical			0.5						
				3	Horizontal	4	225 (at 65 to 365st) 220 (at 415st)	1	106	370				
					Vertical			0.5						
	RRA7C RRA7R	Ball screw	8192	24	Horizontal	30	860	1	52	182				
					Vertical		640	0.5						
				16	Horizontal	20	RRA7C: 700 RRA7R: 560	1	78	273				
					Vertical		560	0.5						
				8	Horizontal	10	420	1	156	547				
					Vertical		RRA7C: 420 RRA7R: 350	0.5						
				4	Horizontal	5	RRA7C: 210 RRA7R: 175	1	312	1094				
					Vertical		0.5							
	RRA8C	Ball screw	8192	20	Horizontal	25	280 (at 50st) 405 (at 100st) 505 (at 150st) 585 (at 200st) 600 (at 250 to 350st) 520 (at 400st) 440 (at 450st) 360 (at 500st) 320 (at 550st) 280 (at 600st) 240 (at 650st) 220 (at 700st)	0.2	167	500				
							Vertical				280 (at 50st) 405 (at 100st) 450 (at 150 to 400st) 440 (at 450st) 360 (at 500st) 320 (at 550st) 280 (at 600st) 240 (at 650st) 220 (at 700st)			
					Horizontal						13	280 (at 50st) 300 (at 100 to 350st) 260 (at 400st) 220 (at 450st) 180 (at 500st) 160 (at 550st) 140 (at 600st) 120 (at 650st) 110 (at 700st)	0.2	333
							Vertical					250 (at 50 to 400st) 220 (at 450st) 180 (at 500st) 160 (at 550st) 140 (at 600st) 120 (at 650st) 110 (at 700st)		

Note The values of the maximum velocity and maximum acceleration/deceleration for RCP6/RCP6CR/RCP6W are the ones when the high-output feature is activated. (There are also some models that are not related to the high-output setting.)

RCP6 Series

Actuator series	Type	Feed screw	No. of encoder pulses	Lead [mm]	Mounting direction	Minimum speed [mm/s]	Maximum speed [mm/s]	Maximum acceleration /deceleration [G]	Minimum push force [N]	Maximum push force [N]	Rated push speed [mm/s]
RCP6 (Radial cylinder)	RRA8C	Ball screw	8192	5	Horizontal/ vertical	7	150 (at 50 to 350st) 130 (at 400st) 110 (at 450st) 90 (at 500st) 80 (at 550st) 70 (at 600st) 60 (at 650st) 55 (at 700st)	0.1	667	2000	10
	RRA8R	Ball screw	8192	20	Horizontal/ vertical	25	280 (at 50st) 400 (at 100 to 450st) 360 (at 500st) 320 (at 550st) 280 (at 600st) 240 (at 650st) 220 (at 700st)	0.2	167	500	10
				10	Horizontal/ vertical	13	200 (at 50 to 450st) 180 (at 500st) 160 (at 550st) 140 (at 600st) 120 (at 650st) 110 (at 700st)	0.2	333	1000	
				5	Horizontal/ vertical	7	100 (at 50 to 450st) 90 (at 500st) 80 (at 550st) 70 (at 600st) 60 (at 650st) 55 (at 700st)	0.1	667	2000	
RCP6 (Wide radial cylinder)	WRA10C WRA10R	Ball screw	8192	16	Horizontal	20	700	WRA10C: 1 WRA10R: 0.7	21	48	20
				10	Horizontal	13	525 (at 50 to 450st) 490 (at 500st)	1	22	77	
				5	Horizontal	7	350 (at 50 to 400st) 290 (at 450st) 240 (at 500st)	1	44	155	
					Vertical		260 (at 50 to 450st) 240 (at 500st)	0.5			
	2.5	Horizontal	4	175 (at 50 to 400st) 145 (at 450st) 120 (at 500st)	1	89	310				
		Vertical		WRA10C: 175 (at 50 to 400st) 145 (at 450st) 120 (at 500st) WRA10R: 150 (at 50 to 400st) 145 (at 450st) 120 (at 500st)	0.5						
	WRA12C WRA12R	Ball screw	8192	20	Horizontal	25	800	1	16	56	20
				12	Horizontal	15	560	1	26	93	
				6	Horizontal	8	400 (at 50 to 450st) 375 (at 500st)	1	53	185	
					Vertical		WRA12C: 340 WRA12R: 280	0.5			
3				Horizontal	4	225 (at 50 to 400st) 220 (at 450st) 185 (at 500st)	1	106	370		
				Vertical		200 (at 50 to 450st) 185 (at 500st)	0.5				

Note The values of the maximum velocity and maximum acceleration/deceleration for RCP6/RCP6CR/RCP6W are the ones when the high-output feature is activated. (There are also some models that are not related to the high-output setting.)

RCP6 Series

Actuator series	Type	Feed screw	No. of encoder pulses	Lead [mm]	Mounting direction	Minimum speed [mm/s]	Maximum speed [mm/s]	Maximum acceleration /deceleration [G]	Minimum push force [N]	Maximum push force [N]	Rated push speed [mm/s]					
RCP6 (Wide radial cylinder)	WRA14C WRA14R	Ball screw	8192	24	Horizontal	30	630	1	52	182	20					
				16	Horizontal	20	560	1	78	273						
				8	Horizontal	10	WRA14C: 420 (at 50 to 550st) 395 (at 600st)	1	156	547						
					Vertical		WRA14R: 350									
				4	Horizontal	5	WRA14C: 210 (at 50 to 550st) 195 (at 600st)	1	312	1094						
					Vertical		WRA14R: 175									
	WRA16C WRA16R	Ball screw	8192	20	Horizontal	25	WRA16C: 280 (at 50st) 405 (at 100st) 450 (at 150 to 450st) 400 (at 500st) 340 (at 550st) 295 (at 600st) 260 (at 650st) 225 (at 700st) 200 (at 750st) 180 (at 800st)	0.2	167	500						
							WRA16R: 280 (at 50st) 405 (at 100st) 420 (at 150 to 450st) 400 (at 500st) 340 (at 550st) 295 (at 600st) 260 (at 650st) 225 (at 700st) 200 (at 750st) 180 (at 800st)									
							10				Horizontal	13	240 (at 50 to 400st) 230 (at 450st) 195 (at 500st) 165 (at 550st) 145 (at 600st) 125 (at 650st) 110 (at 700st) 100 (at 750st) 90 (at 800st)	0.2	333	1000
													WRA16C: 200 (at 50 to 450st) 195 (at 500st) 165 (at 550st) 145 (at 600st) 125 (at 650st) 110 (at 700st) 100 (at 750st) 90 (at 800st)			
							Vertical				13	WRA16R: 180 (at 50 to 450st) 195 (at 500st) 165 (at 550st) 145 (at 600st) 125 (at 650st) 110 (at 700st) 100 (at 750st) 90 (at 800st)				

Note The values of the maximum velocity and maximum acceleration/deceleration for RCP6/RCP6CR/RCP6W are the ones when the high-output feature is activated. (There are also some models that are not related to the high-output setting.)

RCP6 Series

Actuator series	Type	Feed screw	No. of encoder pulses	Lead [mm]	Mounting direction	Minimum speed [mm/s]	Maximum speed [mm/s]	Maximum acceleration /deceleration [G]	Minimum push force [N]	Maximum push force [N]	Rated push speed [mm/s]
RCP6 (Wide radial cylinder)	WRA16C WRA16R	Ball screw	8192	5	Horizontal	7	WRA16C: 130 (at 50 to 400st) 115 (at 450st) 95 (at 500st) 80 (at 550st) 70 (at 600st) 60 (at 650st) 55 (at 700st) 50 (at 750st) 45 (at 800st) WRA16R: 120 (at 50 to 400st) 115 (at 450st) 95 (at 500st) 80 (at 550st) 70 (at 600st) 60 (at 650st) 55 (at 700st) 50 (at 750st) 45 (at 800st)	0.1	667	2000	10
					Vertical		100 (at 50 to 450st) 95 (at 500st) 80 (at 550st) 70 (at 600st) 60 (at 650st) 55 (at 700st) 50 (at 750st) 45 (at 800st)				
RCP6W (Dust and drip proof rod type)	RA4C RA4R	Ball screw	8192	10	Horizontal	13	525	1	33	77	20
					Vertical		435	0.5			
					Horizontal		435	1			
					Vertical		(In ambient temp. 5degC or lower)	0.5			
				5	Horizontal	7	350	1	66	155	
					Vertical		260	0.5			
					Horizontal		(In ambient temp. 5degC or lower)	1			
					Vertical		(In ambient temp. 5degC or lower)	0.5			
	2.5	4	Horizontal	175	1	133	310				
			Vertical	150	0.5						
			Horizontal	130	1						
			Vertical	(In ambient temp. 5degC or lower)	0.5						
	RA6C RA6R	Ball screw	8192	12	Horizontal	15	630	1	40	93	
					Vertical		525	0.5			
					Horizontal		525	1			
					Vertical		(In ambient temp. 5degC or lower)	0.5			
6				8	Horizontal	420	1	79	185		
					Vertical	370	0.5				
					Horizontal	315	1				
					Vertical	(In ambient temp. 5degC or lower)	0.5				
3				4	Horizontal	210	1	159	370		
					Vertical	105	0.5				
					Horizontal	105	1				
					Vertical	(In ambient temp. 5degC or lower)	0.5				

Note The values of the maximum velocity and maximum acceleration/deceleration for RCP6/RCP6CR/RCP6W are the ones when the high-output feature is activated. (There are also some models that are not related to the high-output setting.)

RCP6 Series

Actuator series	Type	Feed screw	No. of encoder pulses	Lead [mm]	Mounting direction	Minimum speed [mm/s]	Maximum speed [mm/s]	Maximum acceleration /deceleration [G]	Minimum push force [N]	Maximum push force [N]	Rated push speed [mm/s]					
RCP6W (Dust and drip proof rod type)	RA7C RA7R	Ball screw	8192	16	Horizontal	20	420	1	117	273	20					
					Vertical			0.5								
					Horizontal		280 (In ambient temp. 5degC or lower)	1								
					Vertical			0.5								
				8	Horizontal	10	350	1	234	547						
					Vertical			0.5								
					Horizontal		140 (In ambient temp. 5degC or lower)	1								
					Vertical			0.5								
	4	Horizontal	5	140	1	469	1094									
		Vertical			0.5											
		Horizontal		105 (In ambient temp. 5degC or lower)	1											
		Vertical			0.5											
	RA8C RA8R	Ball screw	8192	20	Horizontal	25	350	0.2	250	500						
					Vertical						330					
					Horizontal/vertical		200 (In ambient temp. 5degC or lower)					0.2	500	1000		
					Horizontal/vertical						170 (In ambient temp. 5degC or lower)					
5				Horizontal/vertical	7	100	0.1	1000	2000							
				Horizontal/vertical						80 (In ambient temp. 5degC or lower)						
				RCP6W (Dust and drip proof radial cylinder)		RRA4C RRA4R					Ball screw	8192	10	13	525	33
										Vertical						
Horizontal	435 (In ambient temp. 5degC or lower)	0.5														
Vertical			350 (at 50 to 350st) 340 (at 400st)													
5	Horizontal	7			260 (In ambient temp. 5degC or lower)		1	66	155							
	Vertical		0.5													
	Horizontal		175 (at 50 to 350st) 170 (at 400st)		1		133			310						
	Vertical												150			
2.5	Horizontal	4	105 (In ambient temp. 5degC or lower)		0.5											
	Vertical				1											
	RRA6C RRA6R		Ball screw			8192	12	15	630	40	93					
					Vertical							525				
Horizontal		525 (In ambient temp. 5degC or lower)		0.5												
Vertical					420											
6		Horizontal		8			370	1	79	185						
		Vertical			0.5											
		Horizontal			315 (In ambient temp. 5degC or lower)		1									
		Vertical						0.5								
3	Horizontal	4	210	159	370											
	Vertical					0.5										
	Horizontal		105 (In ambient temp. 5degC or lower)				1									
	Vertical					0.5										

Note The values of the maximum velocity and maximum acceleration/deceleration for RCP6/RCP6CR/RCP6W are the ones when the high-output feature is activated. (There are also some models that are not related to the high-output setting.)

RCP6 Series

Actuator series	Type	Feed screw	No. of encoder pulses	Lead [mm]	Mounting direction	Minimum speed [mm/s]	Maximum speed [mm/s]	Maximum acceleration /deceleration [G]	Minimum push force [N]	Maximum push force [N]	Rated push speed [mm/s]												
RCP6W (Dust and drip proof radial cylinder)	RRA7C RRA7R	Ball screw	8192	16	Horizontal	20	420 (In ambient temp. 5degC or lower)	1	117	273	20												
					Vertical			0.5															
					Horizontal			1															
					Vertical			0.5															
				8	Horizontal	10	350 280 140 (In ambient temp. 5degC or lower)	1	234	547													
					Vertical			0.5															
					Horizontal			1															
					Vertical			0.5															
				4	Horizontal	5	140 105 (In ambient temp. 5degC or lower)	1	469	1094													
					Vertical			0.5															
					Horizontal			1															
					Vertical			0.5															
	RRA8C RRA8R	Ball screw	8192	20	Horizontal	25	280 (at 50st) 350 (at 100 to 500st) 320 (at 550st) 280 (at 600st) 240 (at 650st) 220 (at 700st)	0.2	250	500	10												
												Vertical	280 (at 50st) 330 (at 100 to 500st) 320 (at 550st) 280 (at 600st) 240 (at 650st) 220 (at 700st)										
														Horizontal/ vertical	210 (In ambient temp. 5degC or lower)								
					Horizontal/ vertical									13	200 (at 50 to 450st) 180 (at 500st) 160 (at 550st) 140 (at 600st) 120 (at 650st) 110 (at 700st)	0.2	500	1000					
												5	Horizontal/ vertical						7	100 (at 50 to 450st) 90 (at 500st) 80 (at 550st) 70 (at 600st) 60 (at 650st) 55 (at 700st)	0.1	1000	2000
				130 (at 50 to 600st) 120 (at 650st) 110 (at 700st) (In ambient temp. 5degC or lower)																			
					10	Horizontal	7	525 (at 50 to 450st) 490 (at 500st) 350 (In ambient temp. 5degC or lower)	1	33		77											
													5	Horizontal	7	350 (at 50 to 400st) 290 (at 450st) 240 (at 500st)	1	66	155				
				Vertical																215	0.5		
																						Horizontal	215
				Vertical																215 (In ambient temp. 5degC or lower)	0.5		

Note The values of the maximum velocity and maximum acceleration/deceleration for RCP6/RCP6CR/RCP6W are the ones when the high-output feature is activated. (There are also some models that are not related to the high-output setting.)

RCP6 Series

Actuator series	Type	Feed screw	No. of encoder pulses	Lead [mm]	Mounting direction	Minimum speed [mm/s]	Maximum speed [mm/s]	Maximum acceleration /deceleration [G]	Minimum push force [N]	Maximum push force [N]	Rated push speed [mm/s]				
RCP6W (Dust and drip proof wide radial cylinder)	WRA10C WRA10R	Ball screw	8192	2.5	Horizontal	4	175 (at 50 to 400st) 145 (at 450st) 120 (at 500st)	1	133	310	20				
					Vertical		150 (at 50 to 400st) 145 (at 450st) 120 (at 500st)	0.5							
					Horizontal		65	1							
					Vertical		(In ambient temp. 5degC or lower)	0.5							
	WRA12C WRA12R	Ball screw	8192	12	Horizontal	15	560	1	40	93	20				
							(In ambient temp. 5degC or lower)					320			
				6	Horizontal	8	400 (at 50 to 450st) 375 (at 500st)	1	79	185					
							Vertical	220				0.5			
							Horizontal	220				1			
							Vertical	(In ambient temp. 5degC or lower)				0.5			
				3	Horizontal	4	225 (at 50 to 400st) 220 (at 450st) 185 (at 500st)	1	159	370					
							Vertical	140				0.5			
							Horizontal	80				1			
							Vertical	(In ambient temp. 5degC or lower)				0.5			
				WRA14C WRA14R	Ball screw	8192	16	Horizontal	20	420		1	117	273	20
										(In ambient temp. 5degC or lower)					
	8	Horizontal	10				280	1	234	547					
							Vertical	210			0.5				
							Horizontal	140			1				
							Vertical	(In ambient temp. 5degC or lower)			0.5				
	4	Horizontal	5				130	1	469	1094					
							Vertical	70			0.5				
							Horizontal	70			1				
							Vertical	(In ambient temp. 5degC or lower)			0.5				
WRA16C WRA16R	Ball screw	8192	20				Horizontal	25	280 (at 50st) 360 (at 100 to 500st) 340 (at 550st) 295 (at 600st) 260 (at 650st) 225 (at 700st) 200 (at 750st) 180 (at 800st)	0.2	250	500	10		
									240 (at 50 to 650st) 225 (at 700st) 200 (at 750st) 180 (at 800st) (In ambient temp. 5degC or lower)						
WRA16C WRA16R	Ball screw	8192	10	Horizontal	13	220 (at 50 to 450st) 195 (at 500st) 165 (at 550st) 145 (at 600st) 125 (at 650st) 110 (at 700st) 100 (at 750st) 90 (at 800st)	0.2	500	1000	10					

Note The values of the maximum velocity and maximum acceleration/deceleration for RCP6/RCP6CR/RCP6W are the ones when the high-output feature is activated. (There are also some models that are not related to the high-output setting.)

RCP6 Series

Actuator series	Type	Feed screw	No. of encoder pulses	Lead [mm]	Mounting direction	Minimum speed [mm/s]	Maximum speed [mm/s]	Maximum acceleration /deceleration [G]	Minimum push force [N]	Maximum push force [N]	Rated push speed [mm/s]
RCP6W (Dust and drip proof wide radial cylinder)	WRA16C WRA16R	Ball screw	8192	10	Vertical	13	160 (at 50 to 550st) 145 (at 600st) 125 (at 650st) 110 (at 700st) 100 (at 750st) 90 (at 800st)	0.2	500	1000	10
					Horizontal/ vertical		120 (at 50 to 650st) 110 (at 700st) 100 (at 750st) 90 (at 800st) <small>(In ambient temp. 5degC or lower)</small>				
				5	Horizontal	7	110 (at 50 to 450st) 95 (at 500st) 80 (at 550st) 70 (at 600st) 60 (at 650st) 55 (at 700st) 50 (at 750st) 45 (at 800st)	0.1	1000	2000	
					Vertical		90 (at 50 to 500st) 80 (at 550st) 70 (at 600st) 60 (at 650st) 55 (at 700st) 50 (at 750st) 45 (at 800st)				
					Horizontal/ vertical		80 (at 50 to 550st) 70 (at 600st) 60 (at 650st) 55 (at 700st) 50 (at 750st) 45 (at 800st) <small>(In ambient temp. 5degC or lower)</small>				
RCP6 (Table type)	TA4C TA4R (Single Block Type)	Ball screw	8192	16	Horizontal	20	980	1	21	48	20
					Vertical		700	0.5			
				10	Horizontal	13	785	1	22	77	
					Vertical		700	0.5			
				5	Horizontal	7	390	1	44	155	
					Vertical			0.5			
				2.5	Horizontal	4	195	1	89	310	
					Vertical			0.5			
		TA4C TA4R (Double Block Type)	Ball screw	8192	10	Horizontal	13	TA4C: 785 (at 40 to 190st) 680 (at 240st) TA4R: 700 (at 40 to 190st) 680 (at 240st)	1	22	77
						Vertical		TA4C: 700 (at 40 to 190st) 680 (at 240st) TA4R: 525	0.5		
					5	Horizontal	7	390 (at 40 to 190st) 340 (at 240st)	1	44	155
						Vertical		0.5			
2.5					Horizontal	4	195 (at 40 to 190st) 170 (at 240st)	1	89	310	
					Vertical		0.5				

Note The values of the maximum velocity and maximum acceleration/deceleration for RCP6/RCP6CR/RCP6W are the ones when the high-output feature is activated. (There are also some models that are not related to the high-output setting.)

RCP6 Series

Actuator series	Type	Feed screw	No. of encoder pulses	Lead [mm]	Mounting direction	Minimum speed [mm/s]	Maximum speed [mm/s]	Maximum acceleration /deceleration [G]	Minimum push force [N]	Maximum push force [N]	Rated push speed [mm/s]			
RCP6 (Table type)	TA6C TA6R (Single Block Type)	Ball screw	8192	20	Horizontal	25	1120	1	16	56	20			
					Vertical		800	0.5						
				12	Horizontal	15	800	1	26	93				
					Vertical		TA6C: 800 TA6R: 680	0.5						
				6	Horizontal	8	400	1	53	185				
					Vertical		400	0.5						
				3	Horizontal	4	200	1	106	370				
					Vertical		200	0.5						
				TA6C TA6R (Double Block Type)	Ball screw	8192	12	Horizontal	15	800 (at 45 to 220st) 735 (at 270st) 575 (at 320st)		1	26	93
								Vertical		680 (at 45 to 270st) 575 (at 320st)		0.5		
							6	Horizontal	8	400 (at 45 to 220st) 365 (at 270st) 285 (at 320st)		1	53	185
								Vertical		400 (at 45 to 220st) 365 (at 270st) 285 (at 320st)		0.5		
	3	Horizontal	4				200 (at 45 to 220st) 185 (at 270st) 140 (at 320st)	1	106	370				
		Vertical					200 (at 45 to 220st) 185 (at 270st) 140 (at 320st)	0.5						
	TA7C TA7R (Single Block Type)	Ball screw	8192				24	Horizontal	30	1080	1	40	139	
								Vertical		860	0.5			
							16	Horizontal	20	700	1	60	209	
								Vertical		560	0.5			
							8	Horizontal	10	420	1	119	418	
								Vertical		350	0.5			
				4	Horizontal	5	210	1	239	836				
					Vertical		210	0.5						
				TA7C TA7R (Double Block Type)	Ball screw	8192	16	Horizontal	20	700 (at 40 to 340st) 600 (at 390st)	1	60	209	
								Vertical		560	0.5			
8							Horizontal	10	420 (at 40 to 290st) 365 (at 340st) 300 (at 390st)	1	119	418		
							Vertical		350 (at 40 to 340st) 300 (at 390st)	0.5				
4	Horizontal	5	210 (at 40 to 290st) 180 (at 340st) 150 (at 390st)				1	239	836					
	Vertical		210 (at 40 to 290st) 180 (at 340st) 150 (at 390st)				0.5							
RCP6 (Gripper type)	GRT7A	-	8192				1 (Note 1)	-	5	75	0.3	34 (Both Ends)	120 (Both Ends)	5
	GRT7B						1.6 (Note 1) (Gear Ratio Pattern 1)		5	120		42 (Both Ends)	150 (Both Ends)	
							0.8 (Note 1) (Gear Ratio Pattern 2)		5	60		86 (Both Ends)	300 (Both Ends)	
	GRST6C GRST6R	Trapezoid thread on right and left	8192				8	-	10	180	0.3	30 (Both Ends)	110 (Both Ends)	Lead 8: 10 Lead 2: 5
							2		5	45		110 (Both Ends)	310 (Both Ends)	
	GRST7C GRST7R						8		10	180 140 (In ambient temp. 5degC or lower)		100 (Both Ends)	340 (Both Ends)	
				2	5	45	330 (Both Ends)		880 (Both Ends)					

Note The values of the maximum velocity and maximum acceleration/deceleration for RCP6/RCP6CR/RCP6W are the ones when the high-output feature is activated. (There are also some models that are not related to the high-output setting.)

Note1 It is the calculated value of the lead length including the pulley gear ratio.

RCP6 Series

Actuator series	Type	Feed screw	No. of encoder pulses	Lead [mm]	Mounting direction	Minimum speed [mm/s]	Maximum speed [mm/s]	Maximum acceleration /deceleration [G]	Minimum push force [N]	Maximum push force [N]	Rated push speed [mm/s]
RCP6 (Rotary type)	RTFML	-	8192	12deg (Gear ratio: 1/30)	-	15 (deg/s)	800 (deg/s)	0.7	-	-	-
RCP6 (Rotary Chuck) * Rotary part	RTCKSPE	-	8192	90deg (Gear ratio: 1/4)	-	113 (deg/s)	1800 (deg/s)	3	-	-	-
	RTCKSPI										
	RTCKSRE										
	RTCKSRI										
	RTCKMPE	-	8192	72deg (Gear ratio: 1/5)	-	90 (deg/s)	1800 (deg/s)	3	-	-	-
RTCKMPI											
RTCKMRE											
RTCKMRI											

Note The values of the maximum velocity and maximum acceleration/deceleration for RCP6/RCP6CR/RCP6W are the ones when the high-output feature is activated. (There are also some models that are not related to the high-output setting.)

RCP5 Series

Actuator series	Type	Feed screw	No. of encoder pulses	Lead [mm]	Mounting direction	Minimum speed [mm/s]	Maximum speed [mm/s]	Maximum acceleration /deceleration [G]	Minimum push force [N]	Maximum push force [N]	Rated push speed [mm/s]	
RCP5 RCP5CR (Slider type) Standard type / Cleanroom type	[Standard] SA4C SA4R [Cleanroom] SA4C	Ball screw	800	16	Horizontal	20	1260 (at 50 to 400st)	1.0	21	48	20	
					Vertical		1060 (at 450st) 875 (at 500st)	0.5				
				10	Horizontal	13	785 (at 50 to 400st)	1.0	22	77		
					Vertical		675 (at 450st) 555 (at 500st)	0.5				
				5	Horizontal	7	390 (at 50 to 400st)	1.0	44	155		
					Vertical		330 (at 450st) 275 (at 500st)	0.5				
				2.5	Horizontal	4	195 (at 50 to 400st)	1.0	88	310		
					Vertical		165 (at 450st) 135 (at 500st)	0.5				
	RCP5 RCP5CR (Slider type) Standard type / Cleanroom type	[Standard] SA6C SA6R [Cleanroom] SA6C	Ball screw	800	20	Horizontal	25	SA6C: 1440 (at 50 to 450st) 1335 (at 500st) 1130 (at 550st) 970 (at 600st) 840 (at 650st) 735 (at 700st) 650 (at 750st) 575 (at 800st)	1.0	16	56	20
								SA6R: 1280 (at 50 to 500st) 1130 (at 550st) 970 (at 600st) 840 (at 650st) 735 (at 700st) 650 (at 750st) 575 (at 800st)				
					Vertical	1280 (at 50 to 500st) 1130 (at 550st) 970 (at 600st) 840 (at 650st) 735 (at 700st) 650 (at 750st) 575 (at 800st)	0.5					
						900 (at 50 to 400st) 885 (at 450st) 735 (at 500st) 620 (at 550st) 535 (at 600st) 460 (at 650st) 405 (at 700st) 355 (at 750st) 315 (at 800st)	1.0					
12	Vertical	15	SA6C: 900 (at 50 to 400st) 885 (at 450st) 735 (at 500st) 620 (at 550st) 535 (at 600st) 460 (at 650st) 405 (at 700st) 355 (at 750st) 315 (at 800st)	0.5	26	93						
			SA6R: 800 (at 50 to 450st) 735 (at 500st) 620 (at 550st) 535 (at 600st) 460 (at 650st) 405 (at 700st) 355 (at 750st) 315 (at 800st)									

Note The values of the maximum velocity and maximum acceleration/deceleration for RCP5/RCP5CR/RCP5W are the ones when the high-output feature is activated. (There are also some models that are not related to the high-output setting.)

RCP5 Series

Actuator series	Type	Feed screw	No. of encoder pulses	Lead [mm]	Mounting direction	Minimum speed [mm/s]	Maximum speed [mm/s]	Maximum acceleration /deceleration [G]	Minimum push force [N]	Maximum push force [N]	Rated push speed [mm/s]			
RCP5 RCP5CR (Slider type) Standard type / Cleanroom type	[Standard] SA6C SA6R [Cleanroom] SA6C	Ball screw	800	6	Horizontal	8	450 (at 50 to 400st) 435 (at 450st) 365 (at 500st) 305 (at 550st) 265 (at 600st) 230 (at 650st) 200 (at 700st) 175 (at 750st) 155 (at 800st)	1.0	53	185	20			
					Vertical		0.5							
				3	Horizontal	4	225 (at 50 to 400st) 215 (at 450st) 180 (at 500st) 150 (at 550st) 130 (at 600st) 115 (at 650st) 100 (at 700st) 85 (at 750st) 75 (at 800st)	1.0	106	370				
					Vertical		0.5							
				[Standard] SA7C SA7R [Cleanroom] SA7C	Ball screw	800	24	Horizontal	30	SA7C: 1200 (at 50 to 600st) 1145 (at 650st) 1000 (at 700st) 885 (at 750st) 785 (at 800st) SA7R: 1000 (at 50 to 700st) 885 (at 750st) 785 (at 800st)		1.0	40	139
								Vertical		0.5				
	16	Horizontal	20				SA7C: 980 (at 50 to 550st) 875 (at 600st) 755 (at 650st) 660 (at 700st) 585 (at 750st) 520 (at 800st) SA7R: 840 (at 50 to 600st) 755 (at 650st) 660 (at 700st) 585 (at 750st) 520 (at 800st)	1.0	60	209				
		Vertical					0.5							
	8	Horizontal	10				SA7C: 490 (at 50 to 550st) 430 (at 600st) 375 (at 650st) 325 (at 700st) 290 (at 750st) 255 (at 800st) SA7R: 420 (at 50 to 600st) 375 (at 650st) 325 (at 700st) 290 (at 750st) 255 (at 800st)	1.0	119	418				
		Vertical					0.5							

Note The values of the maximum velocity and maximum acceleration/deceleration for RCP5/RCP5CR/RCP5W are the ones when the high-output feature is activated. (There are also some models that are not related to the high-output setting.)

RCP5 Series

Actuator series	Type	Feed screw	No. of encoder pulses	Lead [mm]	Mounting direction	Minimum speed [mm/s]	Maximum speed [mm/s]	Maximum acceleration /deceleration [G]	Minimum push force [N]	Maximum push force [N]	Rated push speed [mm/s]
RCP5 RCP5CR (Slider type)	[Standard] SA7C SA7R	Ball screw	800	4	Horizontal	5	SA7C: 245 (at 50 to 550st) 215 (at 600st) 185 (at 650st) 160 (at 700st) 140 (at 750st) 125 (at 800st)	1.0	239	836	20
					Vertical		SA7R: 210 (at 50 to 600st) 185 (at 650st) 160 (at 700st) 140 (at 750st) 125 (at 800st)				
Standard type / Cleanroom type	[Cleanroom] SA7C						210 (at 50 to 600st) 185 (at 650st) 160 (at 700st) 140 (at 750st) 125 (at 800st)	0.5			
RCP5 (Rod type)	RA4C RA4R	Ball screw	800	16	Horizontal	20	RA4C: 1120 (at 60 to 360st) 1080 (at 410st)	1.0	21	48	20
					Vertical		RA4R: 840	0.5			
				10	Horizontal	13	RA4C: 700 (at 60 to 360st) 685 (at 410st)	1.0	22	77	
					Vertical		RA4R: 610	0.5			
				5	Horizontal	7	350 (at 60 to 360st) 340 (at 410st)	1.0	44	155	
					Vertical			0.5			
				2.5	Horizontal	4	175 (at 60 to 360st) 170 (at 410st)	1.0	88	310	
					Vertical			0.5			
	RA6C RA6R	Ball screw	800	20	Horizontal	25	800	1.0	16	56	
					Vertical			0.5			
				12	Horizontal	15	700	1.0	26	93	
					Vertical			0.5			
				6	Horizontal	8	450	1.0	53	185	
					Vertical			0.5			
				3	Horizontal	4	225 (at 65 to 365st) 220 (at 415st)	1.0	106	370	
					Vertical			0.5			
RA7C RA7R	Ball screw	800	24	Horizontal	30	800	1.0	52	182		
				Vertical			0.5				
			16	Horizontal	20	RA7C: 700 RA7R: 560	1.0	78	273		
				Vertical		560	0.5				
			8	Horizontal	10	RA7C: 420 RA7R: 350	1.0	156	547		
				Vertical			0.5				
			4	Horizontal	5	RA7C: 210	1.0	312	1094		
				Vertical		RA7R: 175	0.5				

Note The values of the maximum velocity and maximum acceleration/deceleration for RCP5/RCP5CR/RCP5W are the ones when the high-output feature is activated. (There are also some models that are not related to the high-output setting.)

RCP5 Series

Actuator series	Type	Feed screw	No. of encoder pulses	Lead [mm]	Mounting direction	Minimum speed [mm/s]	Maximum speed [mm/s]	Maximum acceleration /deceleration [G]	Minimum push force [N]	Maximum push force [N]	Rated push speed [mm/s]
RCP5 (Rod type)	RA8C RA8R	Ball screw	800	20	Horizontal	25	RA8C: 280 (at 50) 405 (at 100st) 505 (at 150st) 585 (at 200st) 600 (at 250 to 350st) 520 (at 400st) 440 (at 450st) 360 (at 500st) 320 (at 550st) 280 (at 600st) 240 (at 650st) 220 (at 700st)	0.2	167	500	10
					Vertical		RA8R: 280 (at 50) 400 (at 100 to 450st) 360 (at 500st) 320 (at 550st) 280 (at 600st) 240 (at 650st) 220 (at 700st)				
				Horizontal	13	RA8C: 280 (at 50) 300 (at 100 to 350st) 260 (at 400st) 220 (at 450st) 180 (at 500st) 160 (at 550st) 140 (at 600st) 120 (at 650st) 110 (at 700st)	0.2	333	1000		
Vertical	RA8R: 200 (at 50 to 450st) 180 (at 500st) 160 (at 550st) 140 (at 600st) 120 (at 650st) 110 (at 700st)										

Note The values of the maximum velocity and maximum acceleration/deceleration for RCP5/RCP5CR/RCP5W are the ones when the high-output feature is activated. (There are also some models that are not related to the high-output setting.)

RCP5 Series

Actuator series	Type	Feed screw	No. of encoder pulses	Lead [mm]	Mounting direction	Minimum speed [mm/s]	Maximum speed [mm/s]	Maximum acceleration /deceleration [G]	Minimum push force [N]	Maximum push force [N]	Rated push speed [mm/s]
RCP5 (Rod type)	RA8C RA8R	Ball screw	800	10	Vertical	13	RA8C: 250 (at 50 to 400st) 220 (at 450st) 180 (at 500st) 160 (at 550st) 140 (at 600st) 120 (at 650st) 110 (at 700st) RA8R: 200 (at 50 to 450st) 180 (at 500st) 160 (at 550st) 140 (at 600st) 120 (at 650st) 110 (at 700st)	0.2	333	1000	10
				5	Horizontal/ vertical	7	RA8C: 150 (at 50 to 350st) 130 (at 400st) 110 (at 450st) 90 (at 500st) 80 (at 550st) 70 (at 600st) 60 (at 650st) 55 (at 700st) RA8R: 100 (at 50 to 450st) 90 (at 500st) 80 (at 550st) 70 (at 600st) 60 (at 650st) 55 (at 700st)	0.1	667	2000	
	RA10C RA10R	Ball screw	800	10	Horizontal	13	RA10C: 117 (at 50st) 167 (at 100st) 200 (at 150st) 250 (at 200 to 500st) 220 (at 550st) 200 (at 600st) 180 (at 650st) 160 (at 700st) 140 (at 750st) 120 (at 800st) RA10R: 117 (at 50st) 167 (at 100st) 200 (at 150 to 600st) 180 (at 650st) 160 (at 700st) 140 (at 750st) 120 (at 800st)	0.04	429	1500	10
				Vertical	RA10C: 117 (at 50st) 167 (at 100 to 650st) 160 (at 700st) 140 (at 750st) 120 (at 800st) RA10R: 117 (at 50st) 140 (at 100 to 750st) 120 (at 800st)						

Note The values of the maximum velocity and maximum acceleration/deceleration for RCP5/RCP5CR/RCP5W are the ones when the high-output feature is activated. (There are also some models that are not related to the high-output setting.)

RCP5 Series

Actuator series	Type	Feed screw	No. of encoder pulses	Lead [mm]	Mounting direction	Minimum speed [mm/s]	Maximum speed [mm/s]	Maximum acceleration /deceleration [G]	Minimum push force [N]	Maximum push force [N]	Rated push speed [mm/s]
RCP5 (Rod type)	RA10C RA10R	Ball screw	800	5	Horizontal/ vertical	7	RA10C: 83 (at 50st) 125 (at 100 to 400st) 110 (at 450st) 90 (at 500st) 80 (at 550st) 70 (at 600st) 60 (at 650st) 55 (at 700st) 50 (at 750st) 45 (at 800st)	0.02	857	3000 (at 550st) 2900 (at 600st) 2500 (at 650st) 2200 (at 700st) 2000 (at 750st) 1800 (at 800st)	10
							RA10R: 83 (at 50st) 100 (at 100 to 450st) 90 (at 500st) 80 (at 550st) 70 (at 600st) 60 (at 650st) 55 (at 700st) 50 (at 750st) 45 (at 800st)				
				2.5	Horizontal/ vertical	4	RA10C: 63 (at 50 to 500st) 55 (at 550st) 50 (at 600st) 45 (at 650st) 40 (at 700st) 35 (at 750st) 30 (at 800st) RA10R: 50 (at 50 to 600st) 45 (at 650st) 40 (at 700st) 35 (at 750st) 30 (at 800st)	0.01	1714	6000 (at 700st) 5900 (at 750st) 5400 (at 800st)	
RCP5W (Dust and drip proof rod type)	RA6C	Ball screw	800	12	Horizontal	15	500 (at 50st) 560 (at 100 to 400st)	1	40	93	20
					Vertical		500	0.5			
					Horizontal		450 (In ambient temp. 5degC or lower)	1			
					Vertical		400 (In ambient temp. 5degC or lower)	0.5			
				6	Horizontal	7.5	360	1	79	185	
					Vertical		300 (In ambient temp. 5degC or lower)	0.5			
					Horizontal		300	1			
					Vertical		300 (In ambient temp. 5degC or lower)	0.5			
				3	Horizontal	3.75	180	1	159	370	
					Vertical		150 (In ambient temp. 5degC or lower)	0.5			
					Horizontal		150	1			
					Vertical		150 (In ambient temp. 5degC or lower)	0.5			
3 (Motor Type: 42SP)	Vertical	3.75	70	0.5	354	590					

Note The values of the maximum velocity and maximum acceleration/deceleration for RCP5/RCP5CR/RCP5W are the ones when the high-output feature is activated. (There are also some models that are not related to the high-output setting.)

RCP5 Series

Actuator series	Type	Feed screw	No. of encoder pulses	Lead [mm]	Mounting direction	Minimum speed [mm/s]	Maximum speed [mm/s]	Maximum acceleration /deceleration [G]	Minimum push force [N]	Maximum push force [N]	Rated push speed [mm/s]			
RCP5W (Dust and drip proof rod type)	RA7C	Ball screw	800	16	Horizontal	20	500 (at 50st) 560 (at 100 to 500st)	1	94	219	20			
					Vertical		500 (at 50st) 400 (at 100 to 500st)	0.5						
					Horizontal		450 (In ambient temp. 5degC or lower)	1						
					Vertical		300 (In ambient temp. 5degC or lower)	0.5						
				8	Horizontal	10	340	1	187	437				
					Vertical		280	0.5						
					Horizontal		300 (In ambient temp. 5degC or lower)	1						
					Vertical		250 (In ambient temp. 5degC or lower)	0.5						
				4	Horizontal	5	170	1	375	875				
							140	0.5						
					Horizontal		150 (In ambient temp. 5degC or lower)	1						
					Vertical		125 (In ambient temp. 5degC or lower)	0.5						
				4 (Motor Type: 56SP)	Vertical	5	80	0.5	515	1030				
				RA8C	Ball screw	800	20	Horizontal	25	280 (at 50st) 405 (at 100st) 480 (at 150 to 400st) 440 (at 450st) 360 (at 500st) 320 (at 550st) 280 (at 600st) 240 (at 650st) 220 (at 700st)		0.2	167	500
										Vertical				
								Horizontal		13				
	Vertical	200 (at 50 to 450st) 180 (at 500st) 160 (at 550st) 140 (at 600st) 120 (at 650st) 110 (at 700st)												

Note The values of the maximum velocity and maximum acceleration/deceleration for RCP5/RCP5CR/RCP5W are the ones when the high-output feature is activated. (There are also some models that are not related to the high-output setting.)

RCP5 Series

Actuator series	Type	Feed screw	No. of encoder pulses	Lead [mm]	Mounting direction	Minimum speed [mm/s]	Maximum speed [mm/s]	Maximum acceleration /deceleration [G]	Minimum push force [N]	Maximum push force [N]	Rated push speed [mm/s]						
RCP5W (Dust and drip proof rod type)	RA8C	Ball screw	800	10	Horizontal	13	210 (at 50 to 450st) 180 (at 500st) 160 (at 550st) 140 (at 600st) 120 (at 650st) 110 (at 700st) (In ambient temp. 5degC or lower)	0.2	333	1000	10						
					Vertical		175 (at 50 to 500st) 160 (at 550st) 140 (at 600st) 120 (at 650st) 110 (at 700st) (In ambient temp. 5degC or lower)										
					5		Horizontal					120 (at 50 to 400st) 110 (at 450st) 90 (at 500st) 80 (at 550st) 70 (at 600st) 60 (at 650st) 55 (at 700st)					
							Vertical					100 (at 50 to 450st) 90 (at 500st) 80 (at 550st) 70 (at 600st) 60 (at 650st) 55 (at 700st)					
				Horizontal		100 (at 50 to 450st) 90 (at 500st) 80 (at 550st) 70 (at 600st) 60 (at 650st) 55 (at 700st) (In ambient temp. 5degC or lower)											
				Vertical		75 (at 50 to 550st) 70 (at 600st) 60 (at 650st) 55 (at 700st) (In ambient temp. 5degC or lower)											
				RA10C	Ball screw	800	10					Horizontal	13	117 (at 50st) 167 (at 100st) 200 (at 150 to 600st) 180 (at 650st) 160 (at 700st) 140 (at 750st) 120 (at 800st)	0.04	429	1500
												Vertical		117 (at 50st) 130 (at 100 to 750st) 120 (at 800st)			
	5	Horizontal/ vertical	7				83 (at 50st) 100 (at 100 to 450st) 90 (at 500st) 80 (at 550st) 70 (at 600st) 60 (at 650st) 55 (at 700st) 50 (at 750st) 45 (at 800st)	0.02	857	3000 (at 550st) 2900 (at 600st) 2500 (at 650st) 2200 (at 700st) 2000 (at 750st) 1800 (at 800st)							

Note The values of the maximum velocity and maximum acceleration/deceleration for RCP5/RCP5CR/RCP5W are the ones when the high-output feature is activated. (There are also some models that are not related to the high-output setting.)

RCP5 Series

Actuator series	Type	Feed screw	No. of encoder pulses	Lead [mm]	Mounting direction	Minimum speed [mm/s]	Maximum speed [mm/s]	Maximum acceleration /deceleration [G]	Minimum push force [N]	Maximum push force [N]	Rated push speed [mm/s]
RCP5W (Dust and drip proof rod type)	RA10C	Ball screw	800	2.5	Horizontal/ vertical	4	50 (at 50 to 600st) 45 (at 650st) 40 (at 700st) 35 (at 750st) 30 (at 800st)	0.01	1714	6000 (at 700st) 5900 (at 750st) 5400 (at 800st)	10
RCP5 (Belt type)	BA4 BA4U	Belt	800	Equivalent to 48	Horizontal	150	890 (at 300st) 1040 (at 400st) 1120 (at 500st) 1160 (at 600st) 1200 (at 700 to 1200st)	0.5	-	-	-
	BA6 BA6U	Belt	800	Equivalent to 48	Horizontal	60	890 (at 300st) 1070 (at 400st) 1220 (at 500st) 1340 (at 600st) 1400 (at 700st) 1440 (at 800st) 1500 (at 900 to 2200st)	0.5	-	-	-
	BA7 BA7U	Belt	800	Equivalent to 48	Horizontal	100	890 (at 300st) 1070 (at 400st) 1220 (at 500st) 1340 (at 600st) 1450 (at 700st) 1520 (at 800st) 1550 (at 900st) 1600 (at 1000 to 2600st)	0.5	-	-	-

Note The values of the maximum velocity and maximum acceleration/deceleration for RCP5/RCP5CR/RCP5W are the ones when the high-output feature is activated. (There are also some models that are not related to the high-output setting.)

RCP4 Series

Actuator series	Type	Feed screw	No. of encoder pulses	Lead [mm]	Mounting direction	Minimum speed [mm/s]	Maximum speed [mm/s]	Maximum acceleration /deceleration [G]	Minimum push force [N]	Maximum push force [N]	Rated push speed [mm/s]			
RCP4 RCP4CR (Slider type) Standard type / Cleanroom type	[Standard] SA3C SA3R [Cleanroom] SA3C	Ball screw	800	6	Horizontal	8	420	1.0	16	58	20			
					Vertical			0.5						
				4	Horizontal	5	280	1.0	25	86				
					Vertical			0.5						
				2	Horizontal	3	140	1.0	49	173				
					Vertical			0.5						
	RCP4 RCP4CR (Slider type)	[Standard] SA5C SA5R [Cleanroom] SA5C	Ball screw	800	20	Horizontal	25	1440 (at 50 to 500st) 1225 (at 550st) 1045 (at 600st) 900 (at 650st) 785 (at 700st) 690 (at 750st) 610 (at 800st)	1.0	16	56	20		
								Vertical					SA5C: 1280 (at 50 to 500st) 1225 (at 550st) 1045 (at 600st) 900 (at 650st) 785 (at 700st) 690 (at 750st) 610 (at 800st)	0.5
													SA5R: 1120 (at 50 to 550st) 1045 (at 600st) 900 (at 650st) 785 (at 700st) 690 (at 750st) 610 (at 800st)	
					12	Horizontal	15	900 (at 50 to 450st) 795 (at 500st) 665 (at 550st) 570 (at 600st) 490 (at 650st) 425 (at 700st) 375 (at 750st) 330 (at 800st)	1.0	26	93			
								Vertical					SA5C: 900 (at 50 to 450st) 795 (at 500st) 665 (at 550st) 570 (at 600st) 490 (at 650st) 425 (at 700st) 375 (at 750st) 330 (at 800st)	0.5
													SA5R: 800 (at 50 to 450st) 795 (at 500st) 665 (at 550st) 570 (at 600st) 490 (at 650st) 425 (at 700st) 375 (at 750st) 330 (at 800st)	

Note The values of the maximum velocity and maximum acceleration/deceleration for RCP4/RCP4CR/RCP4W are the ones when the high-output feature is activated. (There are also some models that are not related to the high-output setting.)

RCP4 Series

Actuator series	Type	Feed screw	No. of encoder pulses	Lead [mm]	Mounting direction	Minimum speed [mm/s]	Maximum speed [mm/s]	Maximum acceleration /deceleration [G]	Minimum push force [N]	Maximum push force [N]	Rated push speed [mm/s]			
RCP4 RCP4CR (Slider type) Standard type / Cleanroom type	[Standard] SA5C SA5R [Cleanroom] SA5C	Ball screw	800	6	Horizontal	8	450 (at 50 to 450st) 395 (at 500st) 335 (at 550st) 285 (at 600st) 245 (at 650st) 215 (at 700st) 185 (at 750st) 165 (at 800st)	1.0	53	185	20			
					Vertical		0.5							
				3	Horizontal	4	225 (at 50 to 450st) 195 (at 500st) 165 (at 550st) 140 (at 600st) 120 (at 650st) 105 (at 700st) 90 (at 750st) 80 (at 800st)	1.0	106	370				
					Vertical		0.5							
				[Standard] SA6C SA6R [Cleanroom] SA6C	Ball screw	800	20	Horizontal	25	SA6C: 1440 (at 50 to 500st) 1230 (at 550st) 1045 (at 600st) 905 (at 650st) 785 (at 700st) 690 (at 750st) 615 (at 800st) SA6R: 1280 (at 50 to 500st) 1230 (at 550st) 1045 (at 600st) 905 (at 650st) 785 (at 700st) 690 (at 750st) 615 (at 800st)		1.0	16	56
								Vertical		0.5				
	12	Horizontal	15				900 (at 50 to 450st) 795 (at 500st) 670 (at 550st) 570 (at 600st) 490 (at 650st) 430 (at 700st) 375 (at 750st) 335 (at 800st)	1.0	26	93				
		Vertical					0.5							

Note The values of the maximum velocity and maximum acceleration/deceleration for RCP4/RCP4CR/RCP4W are the ones when the high-output feature is activated. (There are also some models that are not related to the high-output setting.)

RCP4 Series

Actuator series	Type	Feed screw	No. of encoder pulses	Lead [mm]	Mounting direction	Minimum speed [mm/s]	Maximum speed [mm/s]	Maximum acceleration /deceleration [G]	Minimum push force [N]	Maximum push force [N]	Rated push speed [mm/s]			
RCP4 RCP4CR (Slider type) Standard type / Cleanroom type	[Standard] SA6C SA6R [Cleanroom] SA6C	Ball screw	800	6	Horizontal	8	450 (at 50 to 450st) 395 (at 500st) 335 (at 550st) 285 (at 600st) 245 (at 650st) 215 (at 700st) 185 (at 750st) 165 (at 800st)	1.0	53	185	20			
					Vertical		0.5							
				3	Horizontal	4	225 (at 50 to 450st) 195 (at 500st) 165 (at 550st) 140 (at 600st) 120 (at 650st) 105 (at 700st) 90 (at 750st) 80 (at 800st)	1.0	106	370				
					Vertical		0.5							
				[Standard] SA7C SA7R [Cleanroom] SA7C	Ball screw	800	24	Horizontal	30	SA7C: 1200 (at 50 to 600st) 1155 (at 650st) 1010 (at 700st) 890 (at 750st) 790 (at 800st) SA7R: 1000 (at 50 to 700st) 890 (at 750st) 790 (at 800st)		1.0	40	139
								Vertical		0.5				
	16	Horizontal	20				SA7C: 980 (at 50 to 550st) 865 (at 600st) 750 (at 650st) 655 (at 700st) 580 (at 750st) 515 (at 800st) SA7R: 840 (at 50 to 600st) 750 (at 650st) 655 (at 700st) 580 (at 750st) 515 (at 800st)	1.0	60	209				
							SA7C: 840 (at 50 to 600st) 750 (at 650st) 655 (at 700st) 580 (at 750st) 515 (at 800st) SA7R: 700 (at 50 to 650st) 655 (at 700st) 580 (at 750st) 515 (at 800st)	0.5						
		8					Horizontal	10			SA7C: 490 (at 50 to 550st) 430 (at 600st) 375 (at 650st) 325 (at 700st) 290 (at 750st) 255 (at 800st) SA7R: 420 (at 50 to 600st) 375 (at 650st) 325 (at 700st) 290 (at 750st) 255 (at 800st)	1.0	119	418
							Vertical				0.5			

Note The values of the maximum velocity and maximum acceleration/deceleration for RCP4/RCP4CR/RCP4W are the ones when the high-output feature is activated. (There are also some models that are not related to the high-output setting.)

RCP4 Series

Actuator series	Type	Feed screw	No. of encoder pulses	Lead [mm]	Mounting direction	Minimum speed [mm/s]	Maximum speed [mm/s]	Maximum acceleration /deceleration [G]	Minimum push force [N]	Maximum push force [N]	Rated push speed [mm/s]
RCP4 RCP4CR (Slider type)	[Standard] SA7C SA7R	Ball screw	800	4	Horizontal	5	SA7C: 245 (at 50 to 550st) 215 (at 600st) 185 (at 650st) 160 (at 700st) 145 (at 750st) 125 (at 800st)	1.0	239	836	20
	Standard type / Cleanroom type						[Cleanroom] SA7C				
RCP4W (Dust and drip proof slider type)	SA5C	Ball screw	800	10	Horizontal	13	330	0.6	38.2	66.9	20
				5	Horizontal	7	165		42.3	147.9	
	SA6C	Ball screw	800	12	Horizontal	15	400	0.6	35.5	82.8	20
				6	Horizontal	8	200		51.3	179.5	
	SA7C	Ball screw	800	16	Horizontal	20	530	0.6	60	209	20
				8	Horizontal	10	265		119	418	
RCP4 (Rod type)	RA3C RA3R	Ball screw	800	16	Horizontal	20	1120	1.0	15	36	20
				Vertical	0.5						
				10	Horizontal	13	700	1.0	16	57	
				Vertical	0.5						
				5	Horizontal	7	350	1.0	33	114	
				Vertical	0.5						
				2.5	Horizontal	4	175	1.0	65	229	
				Vertical	0.5						
	RA5C RA5R	Ball screw	800	20	Horizontal	25	800	1.0	16	56	20
				Vertical	0.5						
				12	Horizontal	15	700	1.0	26	93	
				Vertical	0.5						
				6	Horizontal	8	450	1.0	53	185	
				Vertical	0.5						
				3	Horizontal	4	225	1.0	106	370	
				Vertical	0.5						
				3 (Motor Type: 42SP)	Vertical	4	80	0.5	370	750	
				RA6C RA6R	Ball screw	800	24	Horizontal	30	800	
	Vertical	0.5	600								
	16	Horizontal	20				RA6C: 700 RA6R: 560	1.0	78	273	
Vertical	0.5	560									
8	Horizontal	10	420				1.0	156	547		
Vertical	0.5		RA6C: 420 RA6R: 350								
4	Horizontal	5	RA6C: 210 RA6R: 175				1.0	312	1094		
Vertical	0.5										
4 (Motor Type: 56SP)	Vertical	5	90	0.5	470	1106					

Note The values of the maximum velocity and maximum acceleration/deceleration for RCP4/RCP4CR/RCP4W are the ones when the high-output feature is activated. (There are also some models that are not related to the high-output setting.)

RCP4 Series

Actuator series	Type	Feed screw	No. of encoder pulses	Lead [mm]	Mounting direction	Minimum speed [mm/s]	Maximum speed [mm/s]	Maximum acceleration /deceleration [G]	Minimum push force [N]	Maximum push force [N]	Rated push speed [mm/s]			
RCP4W (Dust and drip proof rod type)	RA6C	Ball screw	800	12	Horizontal	15	500 (at 50st) 560 (at 100 to 400st)	1.0	40	93	20			
					Vertical		500	0.5						
					Horizontal		450 (In ambient temp. 5degC or lower)	1.0						
					Vertical		400 (In ambient temp. 5degC or lower)	0.5						
				6	Horizontal	8	360	1.0	79	185				
					Vertical		300	0.5						
					Horizontal		300 (In ambient temp. 5degC or lower)	1.0						
					Vertical		300 (In ambient temp. 5degC or lower)	0.5						
				3	Horizontal	4	180	1.0	159	370				
					Vertical		150	0.5						
					Horizontal		150 (In ambient temp. 5degC or lower)	1.0						
					Vertical		150 (In ambient temp. 5degC or lower)	0.5						
	3 (Motor Type: 42SP)	Vertical	4	70	0.5	354	590							
	RA7C	Ball screw	800	16	Horizontal	20	500 (at 50st) 560 (at 100 to 500st)	1.0	94	219				
					Vertical		500 (at 50st) 400 (at 100 to 500st)	0.5						
					Horizontal		450 (In ambient temp. 5degC or lower)	1.0						
					Vertical		300 (In ambient temp. 5degC or lower)	0.5						
				8	Horizontal	10	340	1.0	187	437				
					Vertical		280	0.5						
					Horizontal		300 (In ambient temp. 5degC or lower)	1.0						
Vertical					250 (In ambient temp. 5degC or lower)		0.5							
4				Horizontal	5	170	1.0	375	875					
				Vertical		140	0.5							
				Horizontal		150 (In ambient temp. 5degC or lower)	1.0							
				Vertical		125 (In ambient temp. 5degC or lower)	0.5							
4 (Motor Type: 56SP)				Vertical	5	80	0.5	515	1030					
RCP4 (Gripper type)				GRSML	-	800	-	-	5	94	0.3	25 (Both Ends)	87 (Both Ends)	5
				GRSLL					5	125		40 (Both Ends)	140 (Both Ends)	
				GRSWL					5	157		50 (Both Ends)	220 (Both Ends)	
				GRLM					20 (deg/s)	600 (deg/s)		10 (Both Ends)	35 (Both Ends)	20
				GROLL					20 (deg/s)	600 (deg/s)		10 (Both Ends)	60 (Both Ends)	
	GRLW	20 (deg/s)	643 (deg/s)	23 (Both Ends)					90 (Both Ends)					

Note The values of the maximum velocity and maximum acceleration/deceleration for RCP4/RCP4CR/RCP4W are the ones when the high-output feature is activated. (There are also some models that are not related to the high-output setting.)

RCP3 Series

Actuator series	Type	Feed screw	No. of encoder pulses	Lead [mm]	Mounting direction	Minimum speed [mm/s]	Maximum speed [mm/s]	Maximum acceleration /deceleration [G]	Minimum push force [N]	Maximum push force [N]	Rated push speed [mm/s]			
RCP3 (Slider type)	SA2AC SA2AR	Lead screw	800	4	Horizontal	5	180 (at 25st) 200 (at 50 to 100st)	0.2	-	-	-			
				2		3	100							
				1		2	50							
	SA2BC SA2BR	Lead screw	800	6	Horizontal	8	180 (at 25st) 280 (at 50st) 300 (at 75 to 150st)	0.2	-	-	-			
				4		5	180 (at 25st) 200 (at 50 to 150st)							
				2		3	100							
	SA3C SA3R	Ball screw	800	6	Horizontal	8	300	0.3	16	30	20			
					Vertical			0.2						
				4	Horizontal	5	200	0.3	25	45				
					Vertical			0.2						
				2	Horizontal/vertical	3	100	0.2	50	90				
					Vertical			0.2						
	SA4C SA4R	Ball screw	800	10	Horizontal	13	500	0.7	25	40	20			
					Vertical			0.3						
				5	Horizontal	7	250	0.7	50	80				
					Vertical			0.3						
				2.5	Horizontal	4	125	0.7	100	160				
					Vertical			0.3						
	SA5C SA5R	Ball screw	800	20 (Only for SA5C)	Horizontal	25	1000 (at 50 to 600st) 910 (at 650st) 790 (at 700st) 690 (at 750st) 610 (at 800st)	0.7	20	34	20			
					Vertical			0.2						
				12	Horizontal	15	600 (at 50 to 550st) 570 (at 600st) 490 (at 650st) 425 (at 700st) 370 (at 750st) 330 (at 800st)	0.7	40	58				
					Vertical			0.3						
				6	Horizontal	8	300 (at 50 to 550st) 285 (at 600st) 245 (at 650st) 210 (at 700st) 185 (at 750st) 165 (at 800st)	0.7	80	115				
					Vertical			0.3						
3				Horizontal	4	150 (at 50 to 550st) 140 (at 600st) 120 (at 650st) 105 (at 700st) 90 (at 750st) 80 (at 800st)	0.7	160	230					
				Vertical			0.3							
SA6C SA6R				Ball screw	800	20 (Only for SA6C)	Horizontal	25	1000 (at 50 to 600st) 910 (at 650st) 790 (at 700st) 690 (at 750st) 610 (at 800st)	0.7		20	34	20
							Vertical			0.2				
						12	Horizontal	15	600 (at 50 to 550st) 570 (at 600st) 490 (at 650st) 425 (at 700st) 370 (at 750st) 330 (at 800st)	0.7		40	58	
							Vertical			0.3				

RCP3 Series

Actuator series	Type	Feed screw	No. of encoder pulses	Lead [mm]	Mounting direction	Minimum speed [mm/s]	Maximum speed [mm/s]	Maximum acceleration /deceleration [G]	Minimum push force [N]	Maximum push force [N]	Rated push speed [mm/s]			
RCP3 (Slider type)	SA6C SA6R	Ball screw	800	6	Horizontal	8	300 (at 50 to 550st) 285 (at 600st) 245 (at 650st) 210 (at 700st) 185 (at 750st) 165 (at 800st)	0.7	80	115	20			
					Vertical			0.3						
				3	Horizontal	4	150 (at 50 to 550st) 140 (at 600st) 120 (at 650st) 105 (at 700st) 90 (at 750st) 80 (at 800st)	0.7	160	230				
					Vertical			0.3						
RCP3 (Rod type)	RA2AC RA2AR	Lead screw	800	4	Horizontal/vertical	5	180 (at 25st) 200 (at 50 to 100st)	0.2	0.9	6.6	5			
									2	3		100	1.9	13.2
													1	2
		4		5	180 (at 25st) 200 (at 50 to 100st)	0.3	3.6	12.6						
						2			3	100		0.3		
												1	2	50
		4		5	180 (at 25st) 200 (at 50 to 100st)	0.3	14.4	50.4						
						2			3	100		0.2		
												1	2	50
		4		5	180 (at 25st) 200 (at 50 to 100st)	0.3	6.6	23.1						
						2			3	100		0.2	13.2	46.2
												1	2	50
	RA2BC RA2BR	Lead screw	800	6	Horizontal/vertical	8	180 (at 25st) 280 (at 50st) 300 (at 75 to 150st)	0.2	0.6	4.4	5			
									4	5		180 (at 25st) 200 (at 50 to 150st)	0.9	6.6
													2	3
		6		8	180 (at 25st) 280 (at 50st) 300 (at 75 to 150st)	0.3	1.8	6.3						
						4			5	180 (at 25st) 200 (at 50 to 150st)		0.2	3.6	12.6
												2	3	100
		6		8	180 (at 25st) 280 (at 50st) 300 (at 75 to 150st)	0.3	14.4	50.4						
						4			5	180 (at 25st) 200 (at 50 to 150st)		0.2		
												2	3	100
		6		8	180 (at 25st) 280 (at 50st) 300 (at 75 to 150st)	0.3	4.4	15.4						
						4			5	180 (at 25st) 200 (at 50 to 150st)		0.2	6.6	23.1
												2	3	100
6	8	180 (at 25st) 280 (at 50st) 300 (at 75 to 150st)	0.3	26.4	92.4									
			4			5	180 (at 25st) 200 (at 50 to 150st)	0.2						
								2	3	100	0.2			

RCP3 Series

Actuator series	Type	Feed screw	No. of encoder pulses	Lead [mm]	Mounting direction	Minimum speed [mm/s]	Maximum speed [mm/s]	Maximum acceleration /deceleration [G]	Minimum push force [N]	Maximum push force [N]	Rated push speed [mm/s]
RCP3 (Table type)	TA3C TA3R	Ball screw	800	6	Horizontal	8	300	0.3	10	15	20
					Vertical		200	0.2			
				4	Horizontal	5	200	0.3	15	22	
					Vertical		133	0.2			
				2	Horizontal	3	100	0.2	30	45	
					Vertical		67				
	TA4C TA4R	Ball screw	800	6	Horizontal	8	300	0.3	15	25	20
					Vertical			0.2			
				4	Horizontal	5	200	0.3	22	37	
					Vertical			0.2			
				2	Horizontal/vertical	3	100	0.2	45	75	
	TA5C TA5R	Ball screw	800	10	Horizontal	13	465	0.3	21	34	20
					Vertical			400			
				5	Horizontal	7	250	0.3	41	68	
					Vertical			0.2			
				2.5	Horizontal/vertical	4	125	0.2	82	136	
	TA6C TA6R	Ball screw	800	12	Horizontal	15	560	0.3	35	60	20
					Vertical		500	0.2			
				6	Horizontal	8	300	0.3	70	110	
					Vertical			0.2			
				3	Horizontal/vertical	4	150	0.2	140	189	
TA7C TA7R	Ball screw	800	12	Horizontal	15	600	0.3	35	60	20	
				Vertical		580	0.2				
			6	Horizontal	8	300	0.3	70	110		
				Vertical			0.2				
			3	Horizontal/vertical	4	150	0.2	140	189		

RCP2 Series

Actuator series	Type	Feed screw	No. of encoder pulses	Lead [mm]	Mounting direction	Minimum speed [mm/s]	Maximum speed [mm/s]	Maximum acceleration /deceleration [G]	Minimum push force [N]	Maximum push force [N]	Rated push speed [mm/s]
RCP2 (Slider type)	SA5C	Ball screw	800	20	Horizontal	25	380 (at 50st) 540 (at 100st) 660 (at 150st) 770 (at 200st) 860 (at 250st) 940 (at 300st) 1000 (at 350 to 550st) 980 (at 600st) 850 (at 650st) 740 (at 700st) 650 (at 750st) 580 (at 800st)	0.7	11	39	20
					Vertical		380 (at 50st) 540 (at 100st) 660 (at 150st) 770 (at 200st) 800 (at 250 to 600st) 740 (at 700st) 650 (at 750st) 580 (at 800st)				
				12	Horizontal	15	600 (at 50 to 550st) 540 (at 600st) 460 (at 650st) 400 (at 700st) 360 (at 750st) 300 (at 800st)	0.7	40	115	
					Vertical		300 (at 50 to 550st) 270 (at 600st) 230 (at 650st) 200 (at 700st) 180 (at 750st) 150 (at 800st)	0.3			
				6	Horizontal	8	300 (at 50 to 550st) 270 (at 600st) 230 (at 650st) 200 (at 700st) 180 (at 750st) 150 (at 800st)	0.7	70	210	
					Vertical		150 (at 50 to 550st) 135 (at 600st) 115 (at 650st) 100 (at 700st) 90 (at 750st) 75 (at 800st)	0.3			
	3	Horizontal	4	150 (at 50 to 550st) 135 (at 600st) 115 (at 650st) 100 (at 700st) 90 (at 750st) 75 (at 800st)	0.7	140	330				
		Vertical		0.3							
	SA5R	Ball screw	800	12	Horizontal	15	600 (at 50 to 550st) 540 (at 600st) 460 (at 650st) 400 (at 700st) 360 (at 750st) 300 (at 800st)	0.3	-	-	-
					Vertical		300 (at 50 to 550st) 270 (at 600st) 230 (at 650st) 200 (at 700st) 180 (at 750st) 150 (at 800st)	0.2			
				6	Horizontal	8	300 (at 50 to 550st) 270 (at 600st) 230 (at 650st) 200 (at 700st) 180 (at 750st) 150 (at 800st)	0.3			
					Vertical		0.2				
3				Horizontal/vertical	4	150 (at 50 to 550st) 135 (at 600st) 115 (at 650st) 100 (at 700st) 90 (at 750st) 75 (at 800st)	0.2				

RCP2 Series

Actuator series	Type	Feed screw	No. of encoder pulses	Lead [mm]	Mounting direction	Minimum speed [mm/s]	Maximum speed [mm/s]	Maximum acceleration /deceleration [G]	Minimum push force [N]	Maximum push force [N]	Rated push speed [mm/s]
RCP2 (Slider type)	SA6C	Ball screw	800	20	Horizontal	25	380 (at 50st) 540 (at 100st) 660 (at 150st) 770 (at 200st) 860 (at 250st) 940 (at 300st) 1000 (at 350 to 550st) 980 (at 600st) 850 (at 650st) 740 (at 700st) 650 (at 750st) 580 (at 800st)	0.7	11	39	20
					Vertical		380 (at 50st) 540 (at 100st) 660 (at 150st) 770 (at 200st) 800 (at 250 to 600st) 740 (at 700st) 650 (at 750st) 580 (at 800st)				
				12	Horizontal	15	600 (at 50 to 550st) 540 (at 600st) 460 (at 650st) 400 (at 700st) 360 (at 750st) 300 (at 800st)	0.7	40	115	
					Vertical		0.3				
				6	Horizontal	8	300 (at 50 to 550st) 270 (at 600st) 230 (at 650st) 200 (at 700st) 180 (at 750st) 150 (at 800st)	0.7	70	210	
					Vertical		0.3				
	3	Horizontal	4	150 (at 50 to 550st) 135 (at 600st) 115 (at 650st) 100 (at 700st) 90 (at 750st) 75 (at 800st)	0.7	140	330				
		Vertical		0.3							
	SA6R	Ball screw	800	12	Horizontal	15	600 (at 50 to 550st) 540 (at 600st) 460 (at 650st) 400 (at 700st) 360 (at 750st) 300 (at 800st)	0.3	-	-	-
					Vertical		0.2				
				6	Horizontal	8	300 (at 50 to 550st) 270 (at 600st) 230 (at 650st) 200 (at 700st) 180 (at 750st) 150 (at 800st)	0.3			
					Vertical		0.2				
3				Horizontal/vertical	4	150 (at 50 to 550st) 135 (at 600st) 115 (at 650st) 100 (at 700st) 90 (at 750st) 75 (at 800st)	0.2				

RCP2 Series

Actuator series	Type	Feed screw	No. of encoder pulses	Lead [mm]	Mounting direction	Minimum speed [mm/s]	Maximum speed [mm/s]	Maximum acceleration /deceleration [G]	Minimum push force [N]	Maximum push force [N]	Rated push speed [mm/s]			
RCP2 (Slider type)	SA7C	Ball screw	800	16	Horizontal	20	533 (at 50 to 700st)	0.3	90	250	20			
					Vertical		480 (at 800st)	0.2						
				8	Horizontal	10	266 (at 50 to 700st)	0.3	150	500				
					Vertical		240 (at 800st)	0.2						
				4	Horizontal/vertical	5	133 (at 50 to 700st)	0.2	280	800				
					Vertical		120 (at 800st)							
	SA7R	Ball screw	800	16	Horizontal	20	533 (at 50 to 700st)	0.3	-	-	-			
					Vertical		400	0.2						
				8	Horizontal	10	266 (at 50 to 700st)	0.3	-	-				
					Vertical		240 (at 800st)	0.2						
				4	Horizontal/vertical	5	133 (at 50 to 700st)	0.2	-	-				
					Vertical		120 (at 800st)							
	SS7C	Ball screw	800	12	Horizontal	15	600 (at 50 to 500st)	0.3	40	115	20			
					Vertical		470 (at 600st)	0.2						
				6	Horizontal	8	300 (at 50 to 500st)	0.3	70	210				
					Vertical		230 (at 600st)	0.2						
				3	Horizontal/vertical	4	150 (at 50 to 500st)	0.2	140	330				
					Vertical		115 (at 600st)							
	SS7R	Ball screw	800	12	Horizontal	15	600 (at 50 to 500st)	0.3	-	-	-			
					Vertical		440	0.2						
				6	Horizontal	8	250 (at 50 to 500st)	0.3	-	-				
					Vertical		230 (at 600st)	0.2						
				3	Horizontal/vertical	4	105	0.2	-	-				
					Vertical									
	SS8C	Ball screw	800	20	Horizontal	25	666 (at 50 to 800st)	0.3	50	180	20			
					Vertical		625 (at 900st)					0.2		
				10	Horizontal	13	333 (at 50 to 800st)	0.3	95	320				
					Vertical		310 (at 900st)					0.2		
				5	Horizontal	7	255 (at 1000st)	0.2	180	630				
					Vertical		300 (at 50 to 900st)					125 (at 1000st)		
SS8R				Ball screw	800	20	Horizontal	25	600 (at 50 to 900st)	0.3		-	-	-
							Vertical		515 (at 1000st)	0.2				
						10	Horizontal	13	300 (at 50 to 900st)	0.3		-	-	
							Vertical		255 (at 1000st)					
						5	Horizontal	7	160 (at 50 to 800st)	0.2		-	-	
							Vertical		155 (at 900st)					
HS8C HS8R	Ball screw	800	30	Horizontal	100	1200 (at 50 to 800st)	0.5	-	-	-				
				Vertical		1000 (at 900st)					800 (at 1000st)			
						750	0.2							

RCP2 Series

Actuator series	Type	Feed screw	No. of encoder pulses	Lead [mm]	Mounting direction	Minimum speed [mm/s]	Maximum speed [mm/s]	Maximum acceleration /deceleration [G]	Minimum push force [N]	Maximum push force [N]	Rated push speed [mm/s]
RCP2W (Dust and drip proof slider type)	SA16C	Ball screw	800	8	Horizontal	10	180	0.2	-	-	-
				4		5	133				
RCP2 (Belt type)	BA6 BA6U	Belt	800	Equivalent to 54	Horizontal	100	1000	0.5	-	-	-
	BA7 BA7U	Belt	800	Equivalent to 54	Horizontal	100	1500	0.5	-	-	-
RCP2 (Rod type)	RA2C (Note 1)	Ball screw	800	1	Horizontal/ vertical	2	25	0.05	50	100	3
	RA3C	Ball screw	800	5	Horizontal/ vertical	7	187	0.2	21	73.5	20
				2.5	Horizontal/ vertical	4	114		50	156.8	
	RGD3C	Ball screw	800	5	Horizontal/ vertical	7	187	0.2	21	73.5	20
				2.5	Horizontal	4	114		50	156.8	
					Vertical	4	93		50	156.8	
	RA4C RGS4C RGD4C	Ball screw	800	10	Horizontal/ vertical	13	458 (at 50 to 250st) 350 (at 300st)	0.2	30	150	20
				5	Horizontal/ vertical	7	250 (at 50 to 200st) 237 (at 250st) 175 (at 300st)		75	284	
				2.5	Horizontal	4	125 (at 50 to 200st) 118 (at 250st) 87 (at 300st)		150	358	
					Vertical	4	114 (at 50 to 250st) 87 (at 300st)		150	358	
	RA6C RGS6C RGD6C	Ball screw	800	16	Horizontal/ Vertical	20	450	0.2	75	240	20
				8	Horizontal/ vertical	10	210		130	470	
				4	Horizontal/ vertical	5	130		300	800	
	RA8C RA8R	Ball screw	800	10	Horizontal/ vertical	13	RA8C:300 RA8R:200	0.2	286	1000	10
				5	Horizontal/ vertical	7	RA8C:150 RA8R:100	0.1	571	2000	
	RA10C	Ball screw	800	10	Horizontal	10	250	0.04	500	1500	10
Vertical					10	167					
5				Horizontal/ vertical	5	125	0.02	1000	3000		
SRA4R SRGS4R SRGD4R	Ball screw	800	5	Horizontal	7	250	0.3	32	112	20	
				Vertical	7	250	0.2	32	112		
			2.5	Horizontal/ vertical	4	125	0.2	64	224		

Note 1 For RCP2-RA2C, a ball screw with its lead length 1mm and a speed reducer with its gear ratio 1/2 are joined directly.

RCP2 Series

Actuator series	Type	Feed screw	No. of encoder pulses	Lead [mm]	Mounting direction	Minimum speed [mm/s]	Maximum speed [mm/s]	Maximum acceleration /deceleration [G]	Minimum push force [N]	Maximum push force [N]	Rated push speed [mm/s]	
RCP2W (Dust and drip proof rod type)	RA4C	Ball screw	800	10	Horizontal	13	450 (at 50 to 250st) 350 (at 300st)	0.2	30	150	20	
					Vertical		250					
				5	Horizontal/vertical	7	190 (at 50 to 250st) 175 (at 300st)		75	284		
					2.5		Horizontal					4
				Vertical		115 (at 50 to 250st) 85 (at 300st)						
				RA6C	Ball screw	800	16		Horizontal	20		320
	Vertical	265										
	8	Horizontal/vertical	10				200	130	470			
		4		Horizontal/vertical	5	100	300			800		
	RA10C		Ball screw	800		10		Horizontal	10		250	0.04
		Vertical			167							
		5			Horizontal/vertical	5	125	1000	3000			
2.5	Horizontal/vertical		1	63	3100		6000					
	RCP2 (Gripper type)	GRSS		-		800		-	-	5	78	-
GRLS		12	5 (deg/s)		600 (deg/s)		1.8 (Both Ends)			6.4 (Both Ends)	20 (deg/s)	
GRS		1.5	5		33		9 (Both Ends)			21 (Both Ends)	5	
GRM		1.5	5		36		23 (Both Ends)			80 (Both Ends)	5	
GRHM		2	5		100		25 (Both Ends)			125 (Both Ends)	5	
GRHB		2	5		100		60 (Both Ends)			200 (Both Ends)	5	
GRST		1.05	5		34 (Standard Type)		15 (Both Ends)			40 (Both Ends)	5	
		2.27	5		75 (High Speed Type)		7.5 (Both Ends)			20 (Both Ends)	5	
GR3SS		2.5	5		40		7 (Both Ends)			22 (Both Ends)	5	
GR3SM		3	5		50		30 (Both Ends)			102 (Both Ends)	5	
GR3LS		12	5 (deg/s)		200 (deg/s)		5 (Both Ends)			18 (Both Ends)	20 (deg/s)	
GR3LM		12	5 (deg/s)		200 (deg/s)		15 (Both Ends)			51 (Both Ends)	20 (deg/s)	

RCP2 Series

Actuator series	Type	Feed screw	No. of encoder pulses	Lead [mm]	Mounting direction	Minimum speed [mm/s]	Maximum speed [mm/s]	Maximum acceleration /deceleration [G]	Minimum push force [N]	Maximum push force [N]	Rated push speed [mm/s]
RCP2CR RCP2W (Cleanroom type / Dust and drip proof gripper type)	GRSS	-	800	1.57	-	5	78	-	4 (Both Ends)	14 (Both Ends)	5
	GRLS			12		5 (deg/s)	600 (deg/s)		1.8 (Both Ends)	6.4 (Both Ends)	20 (deg/s)
	GRS			1.5		5	33		9 (Both Ends)	21 (Both Ends)	5
	GRM			1.5		5	36		23 (Both Ends)	80 (Both Ends)	5
	GR3SS			2.5		5	40		7 (Both Ends)	22 (Both Ends)	5
	GR3SM			3		5	50		30 (Both Ends)	102 (Both Ends)	5
RCP2 RCP2CR RCP2W (Rotary type)	RTBS RTBSL RTCS RTCSL	-	800	12deg (Gear ratio: 1/30)	-	15 (deg/s)	400 (deg/s)	-	-	-	-
				8deg (Gea ratio: 1/45)		10 (deg/s)	266 (deg/s)				
Standard type / Cleanroom type / Dust and drip proof type	RTB RTBL RTC RTCL RTBB RTBBL RTCB RTCBL	-	800	18deg (Gear ratio: 1/20)	-	23 (deg/s)	600 (deg/s)	-	-	-	-
				12deg (Gear ratio: 1/30)		15 (deg/s)	400 (deg/s)				

9.6.2 Correlation Diagrams of Speed and Payload

Correlation diagram of speed and payload for the RCP6 slider type (High output effective)

* Characteristics should be the same for Cleanroom type.

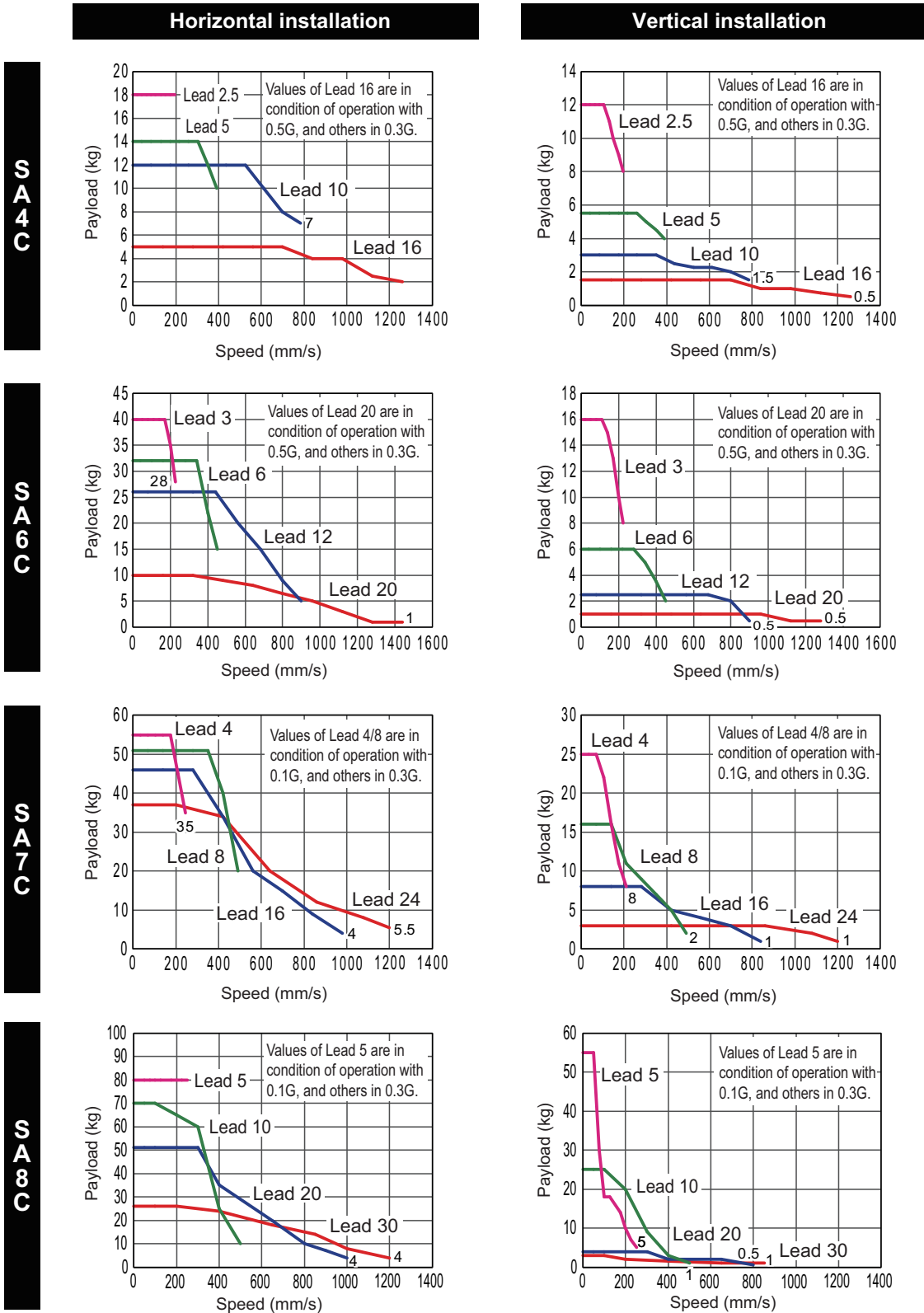

Correlation diagram of speed and payload for the RCP6 slider type (High output effective / Motor-reversing type)

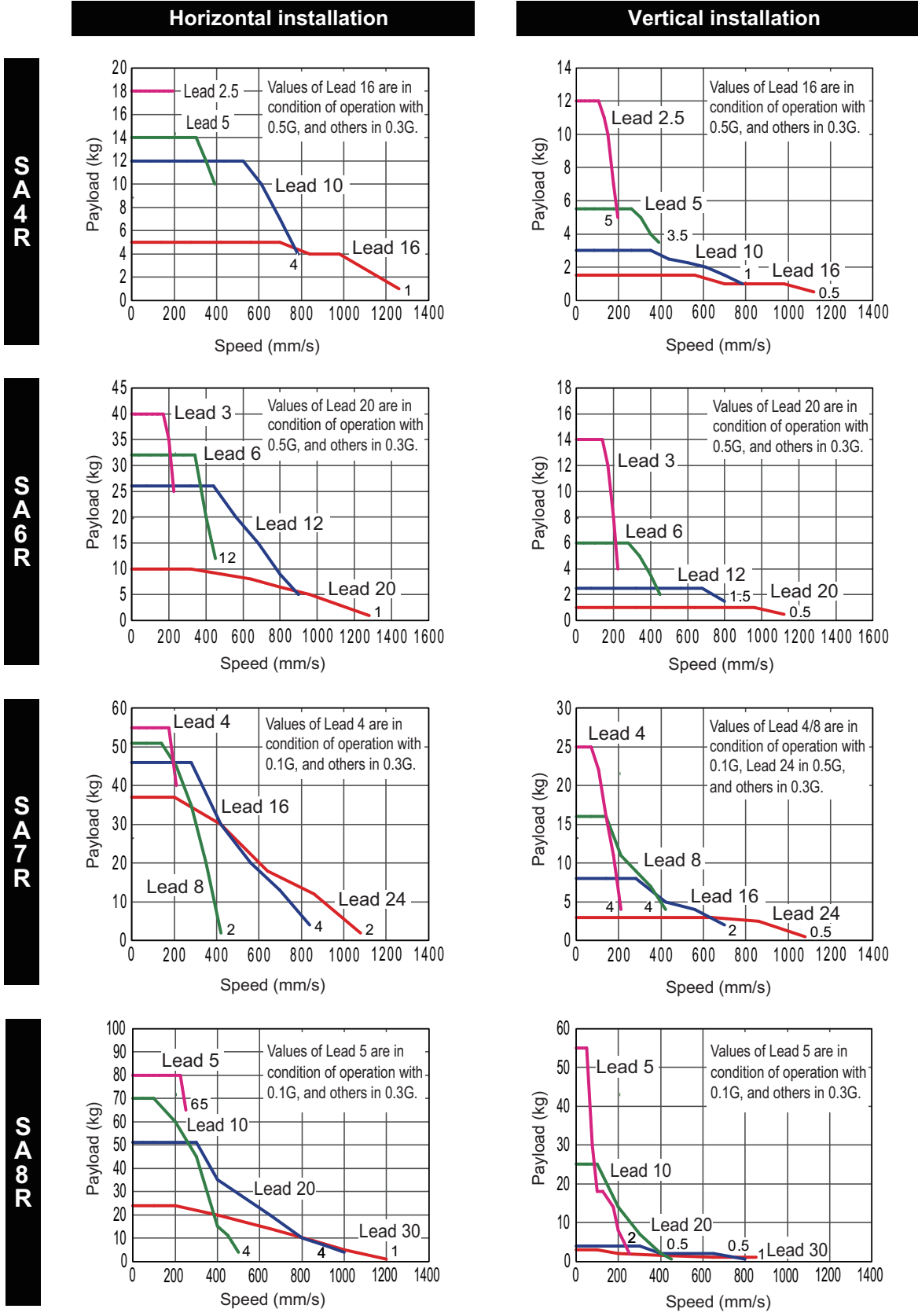

Correlation diagram of speed and payload for the RCP6 wide slider type (High output effective)

* Characteristics should be the same for Cleanroom type.

Horizontal installation

Vertical installation

W
S
A
10
C

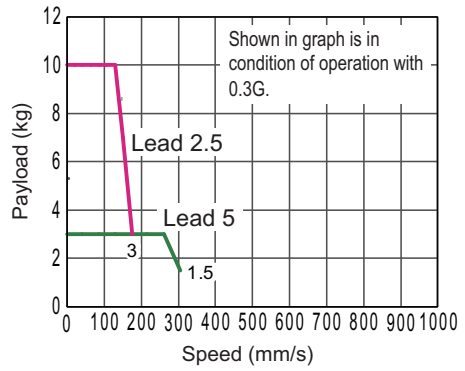
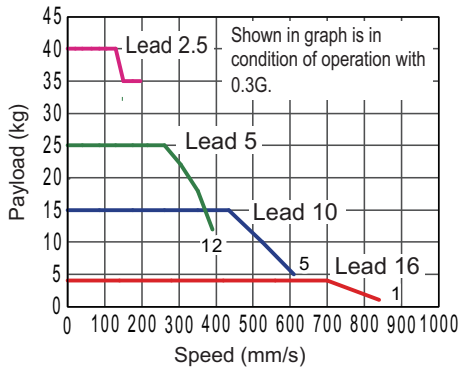

W
S
A
12
C

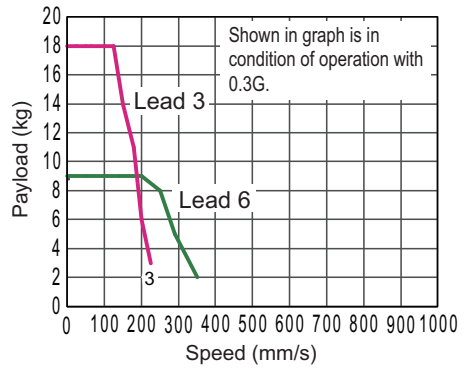
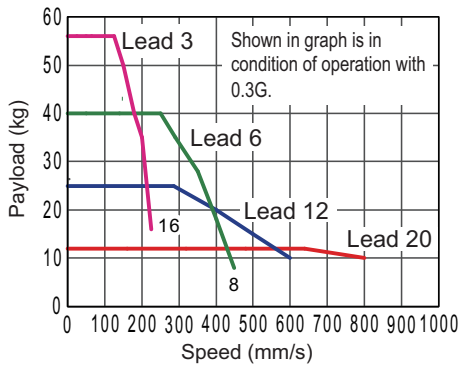

W
S
A
14
C

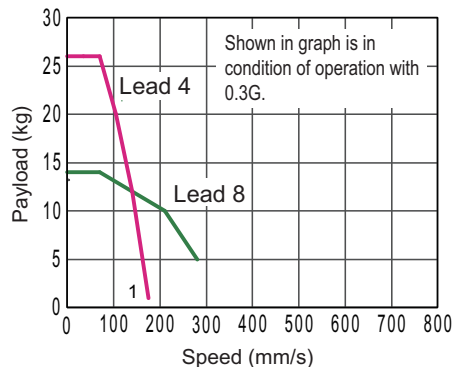
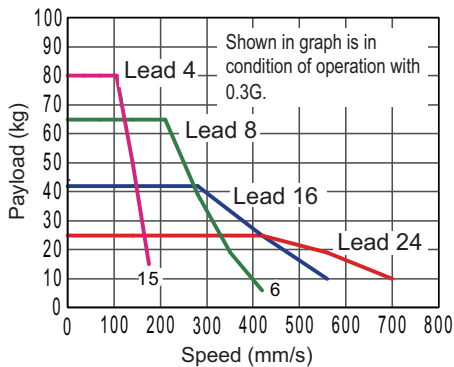

W
S
A
16
C

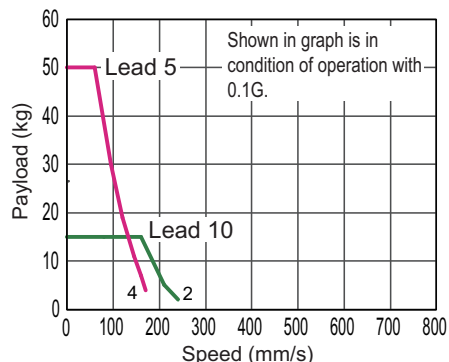
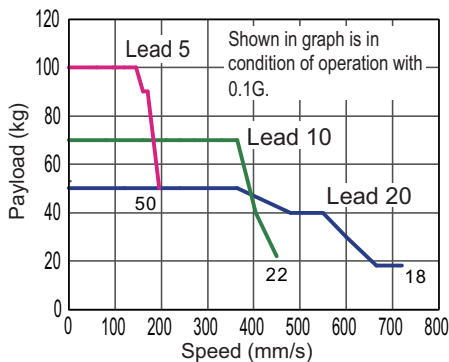

Correlation diagram of speed and payload for the RCP6 wide slider type (High output effective / Motor-reversing type)

Horizontal installation

Vertical installation

WSA 10 R

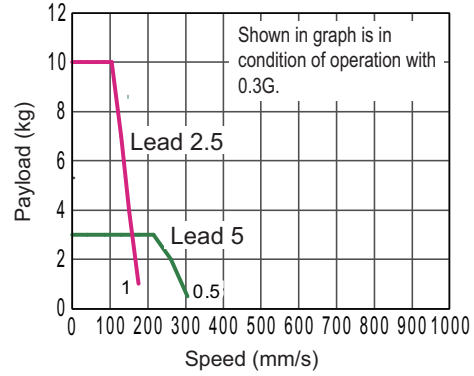
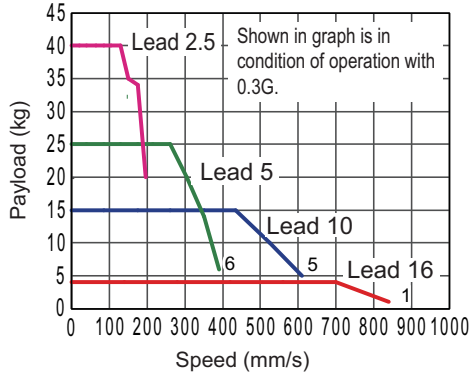

WSA 12 R

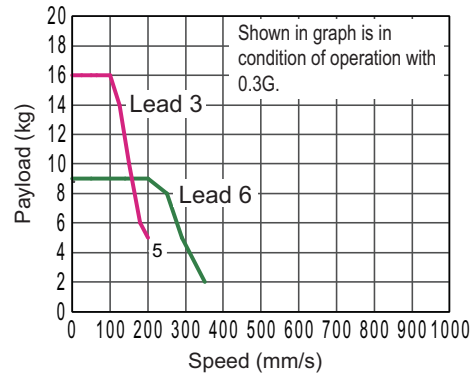
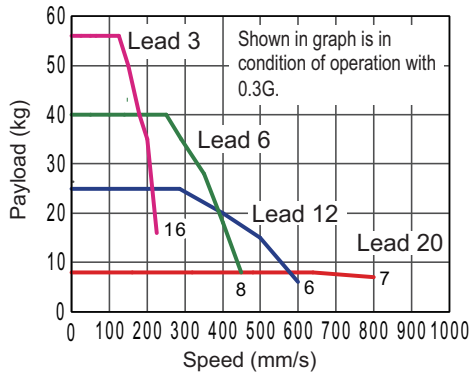

WSA 14 R

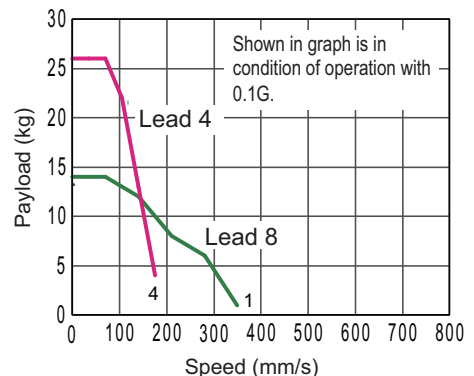
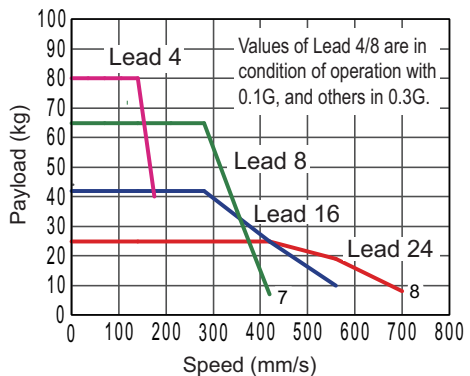

WSA 16 R

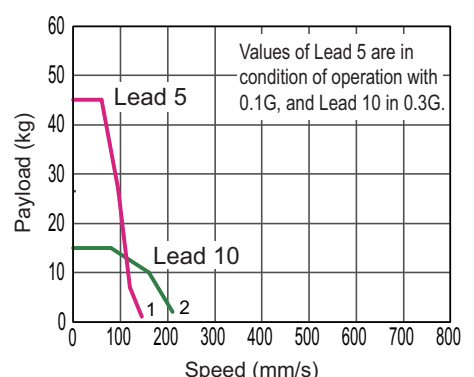
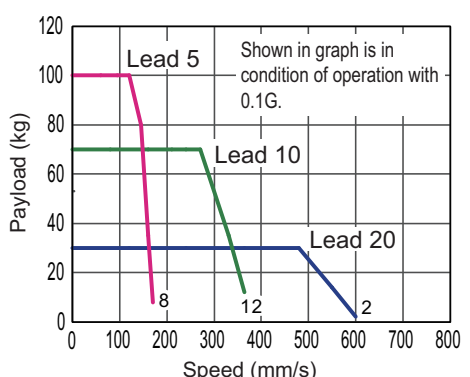

Correlation diagram of speed and payload for the RCP6 rod type (High output effective)

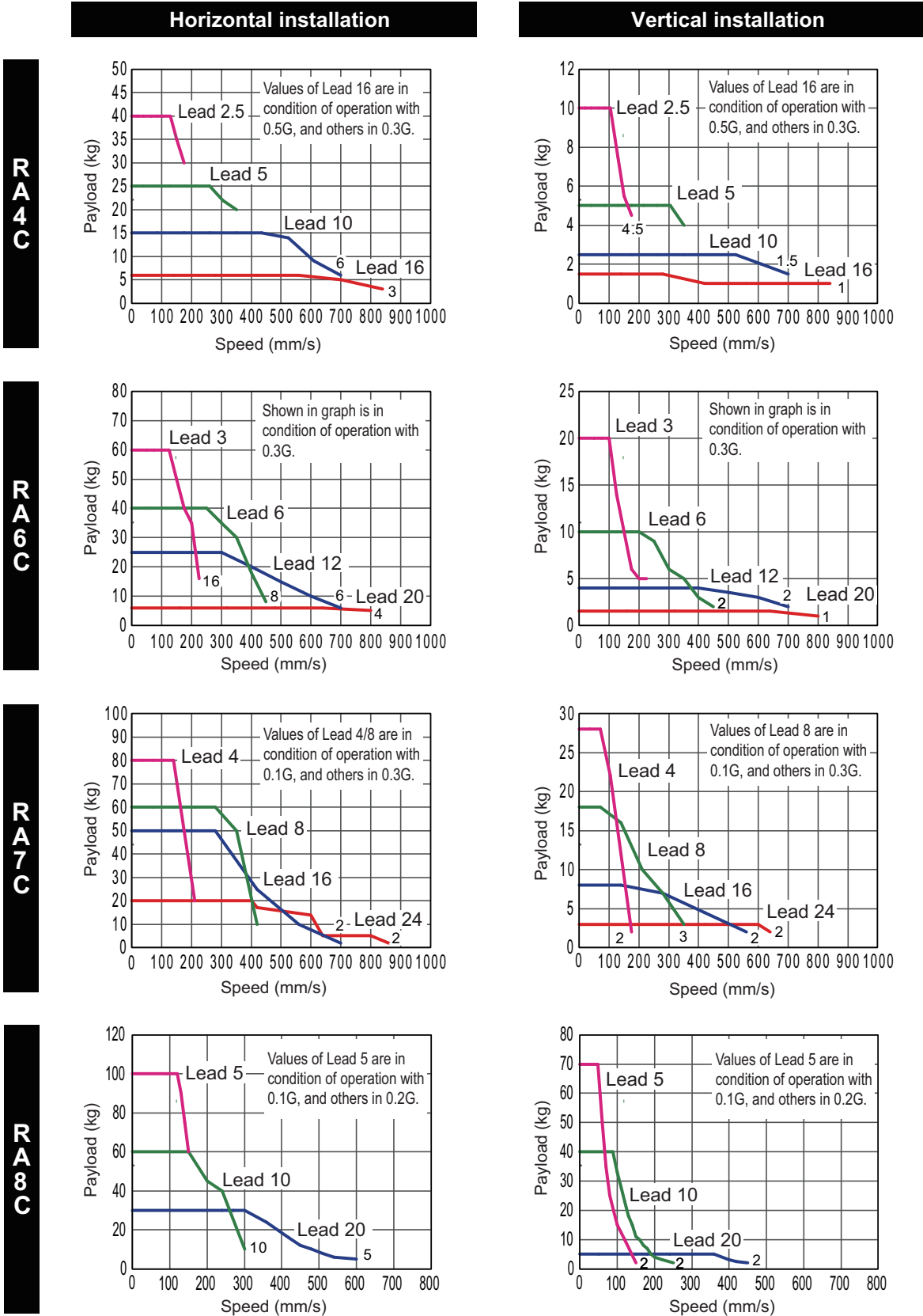

Correlation diagram of speed and payload for the RCP6 rod type (High output effective / Motor-reversing type)

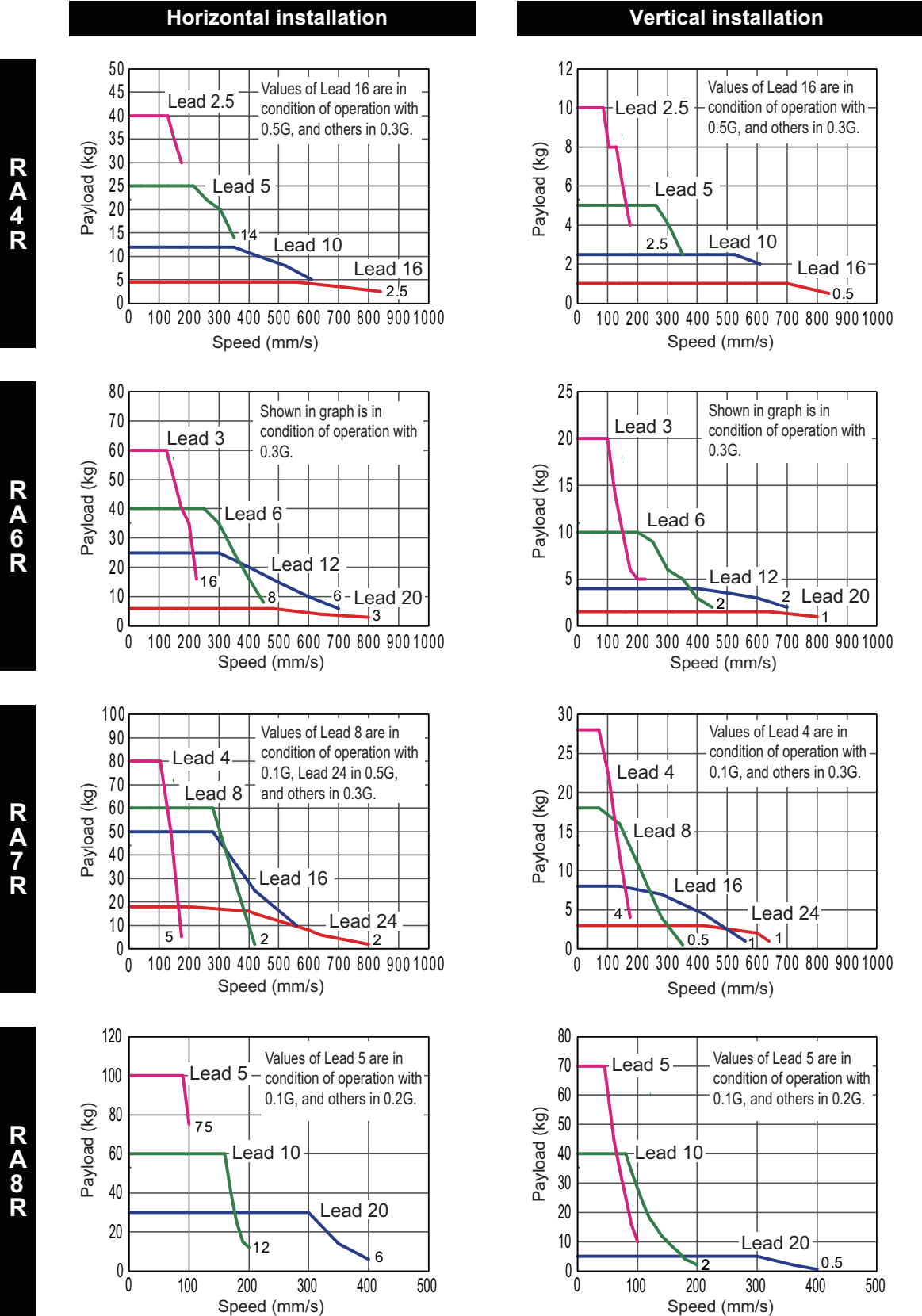

Correlation diagram of speed and payload for the RCP6 radial cylinder type (High output effective)

Horizontal installation

Vertical installation

RRA4C

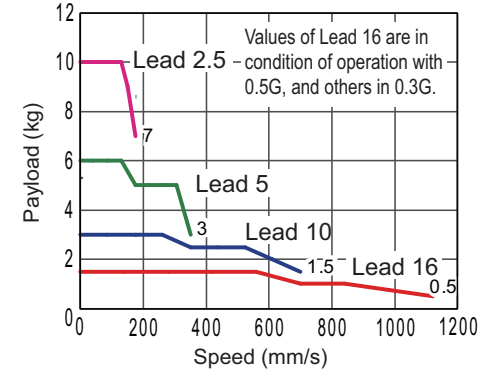
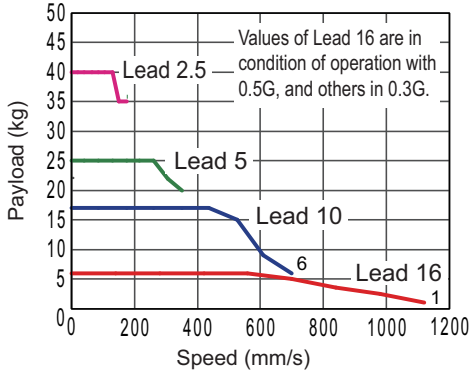

RRA6C

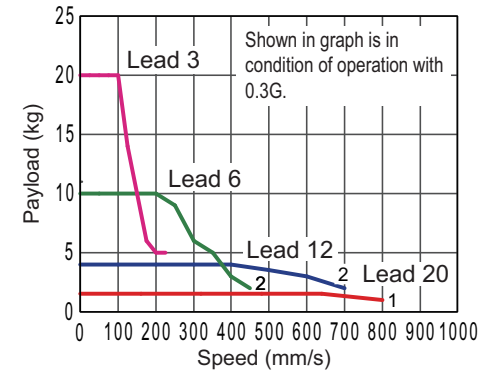
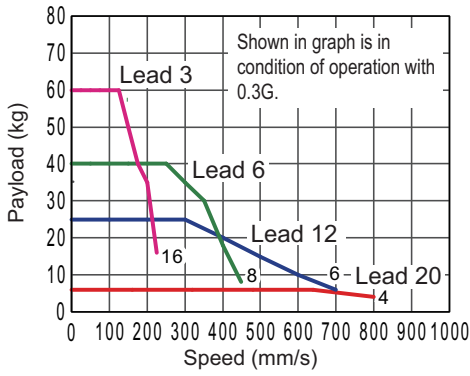

RRA7C

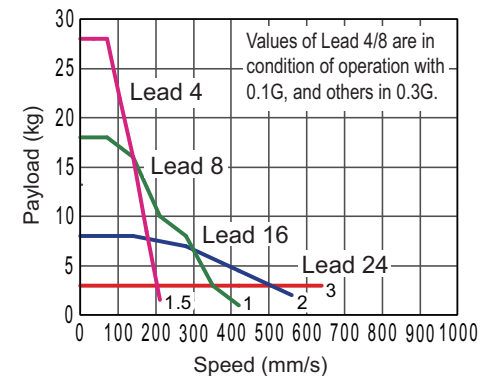
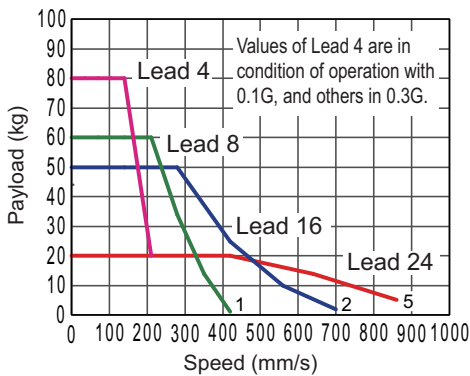

RRA8C

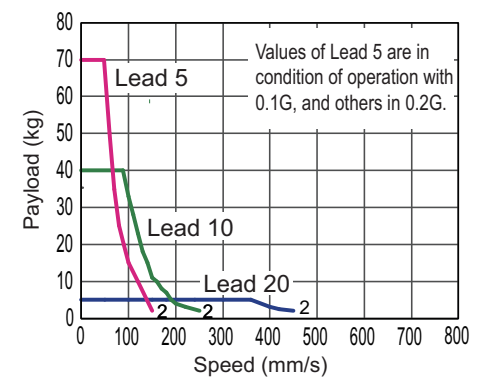
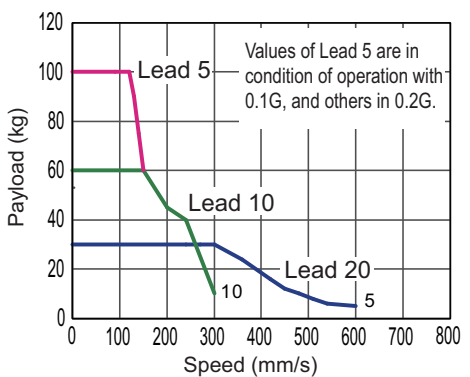

Chapter 9 Appendix

Correlation diagram of speed and payload for the RCP6 radial cylinder type (High output effective / Motor-reversing type)

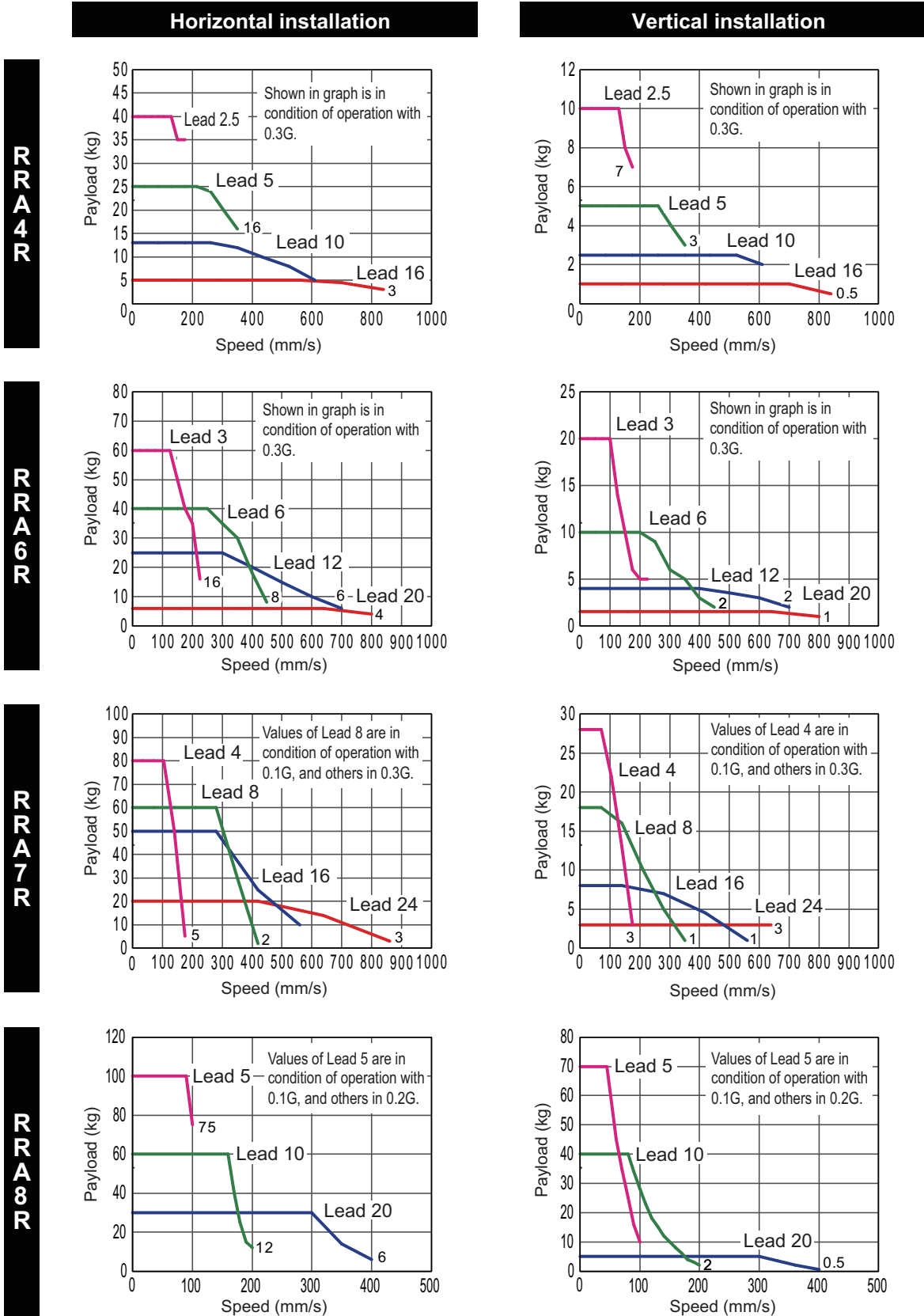

Correlation diagram of speed and payload for the RCP6 wide radial cylinder type (High output effective)

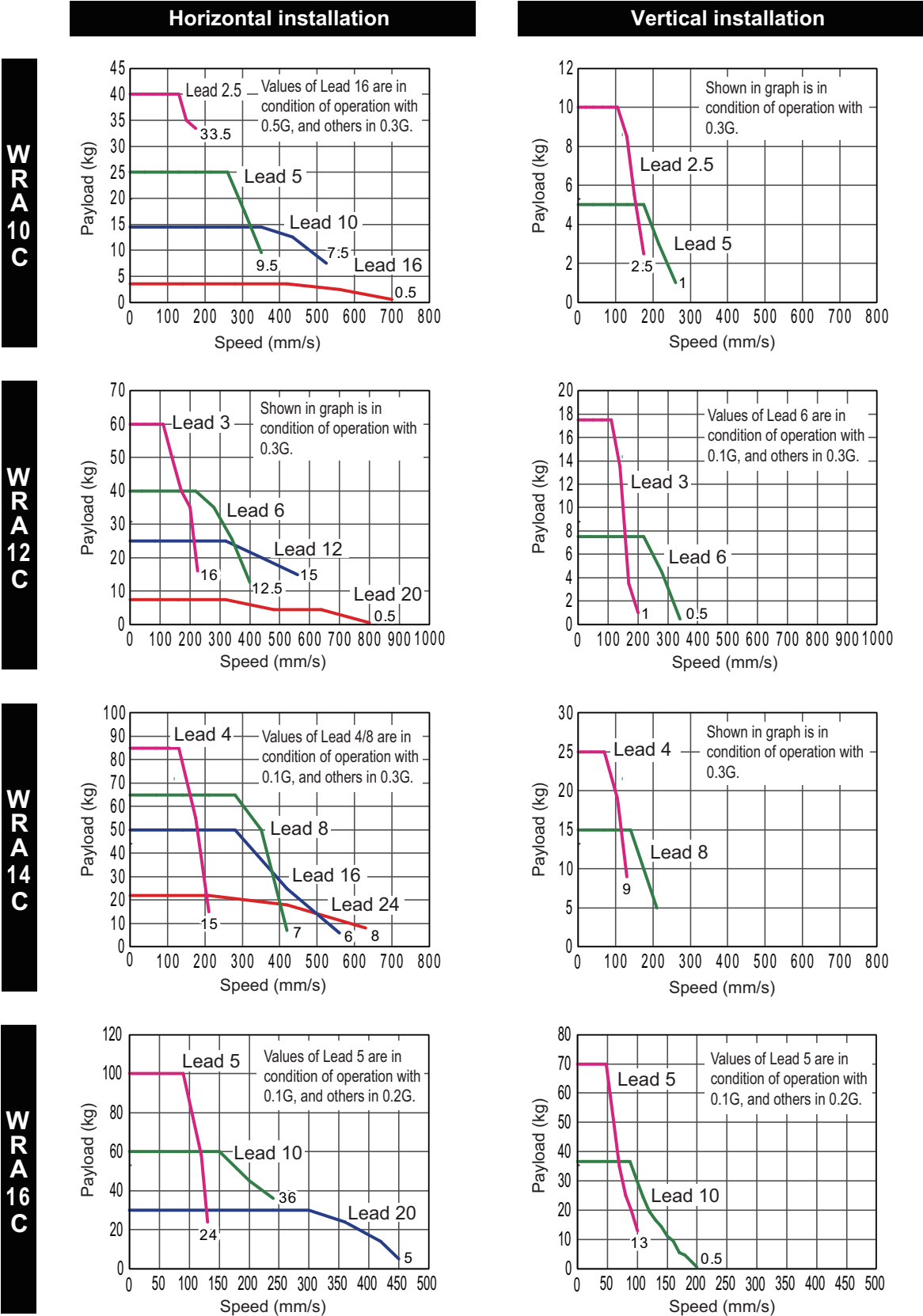

Correlation diagram of speed and payload for the RCP6 wide radial cylinder type (High output effective / Motor-reversing type)

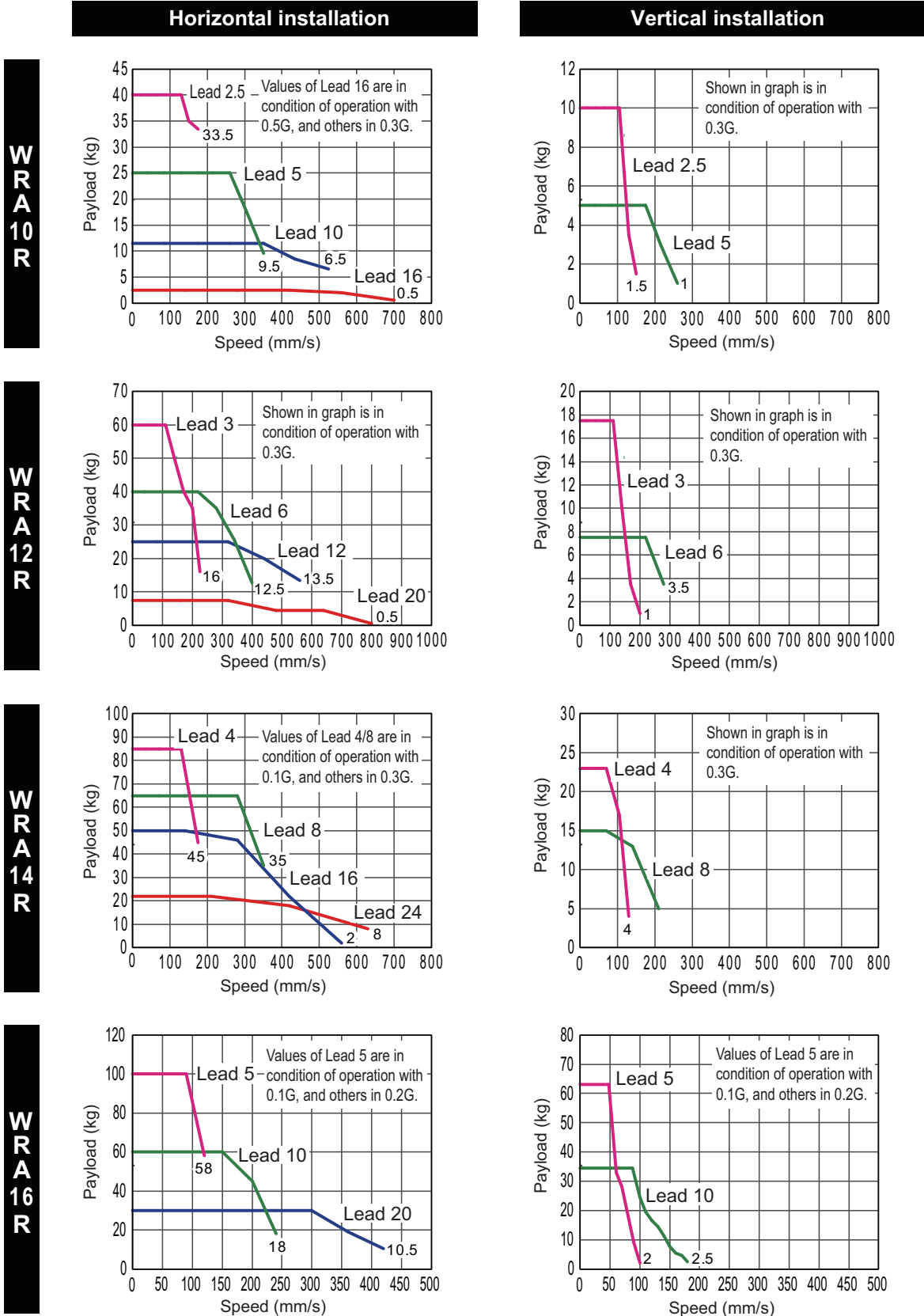

Correlation diagram of speed and payload for the RCP6W dust and drip proof rod type (High output effective)

R A 4 C

R A 6 C

Horizontal installation

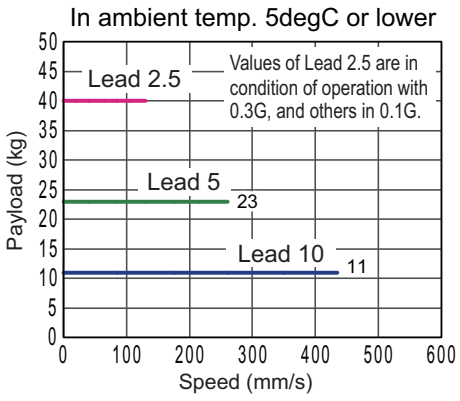
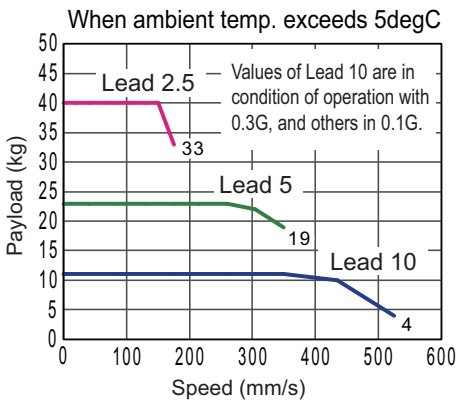

Vertical installation

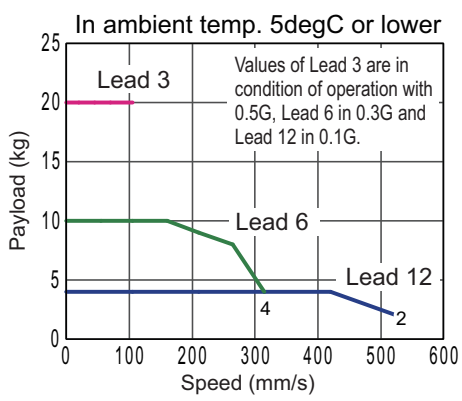
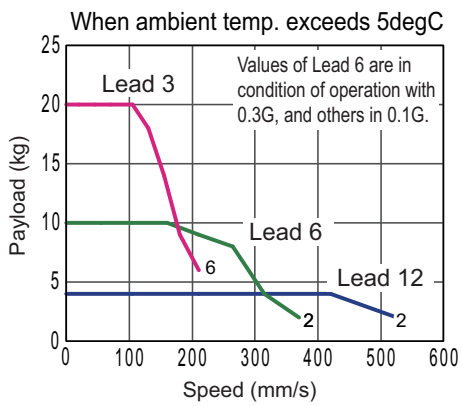
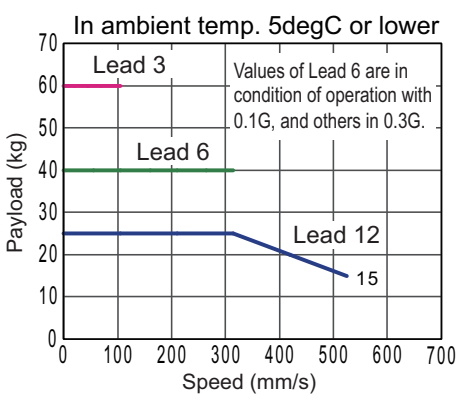
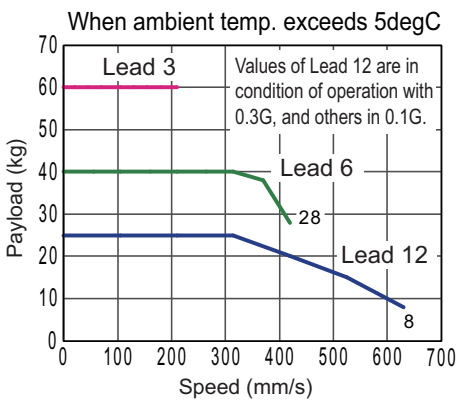
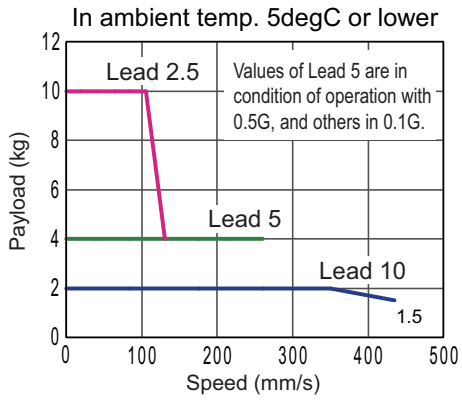
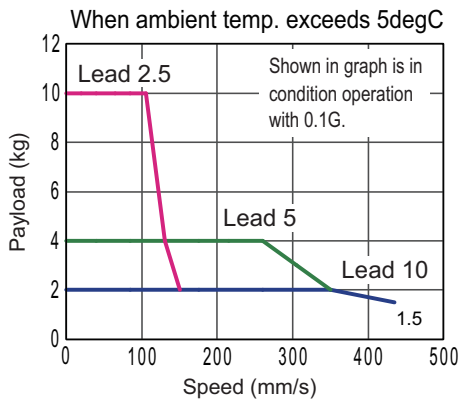

Chapter 9 Appendix

Correlation diagram of speed and payload for the RCP6W dust and drip proof rod type (High output effective)

R A 7 C

Horizontal installation

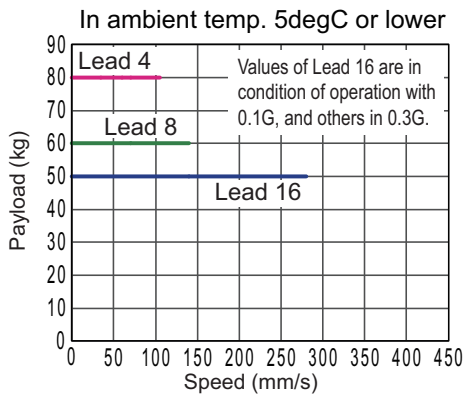
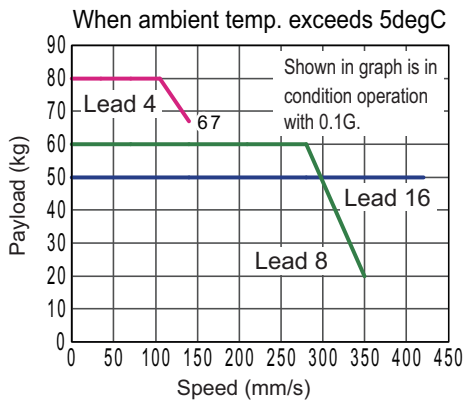

Vertical installation

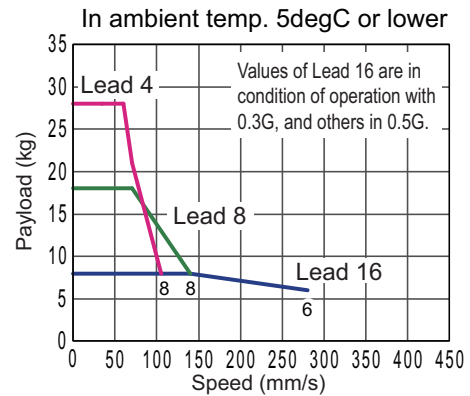
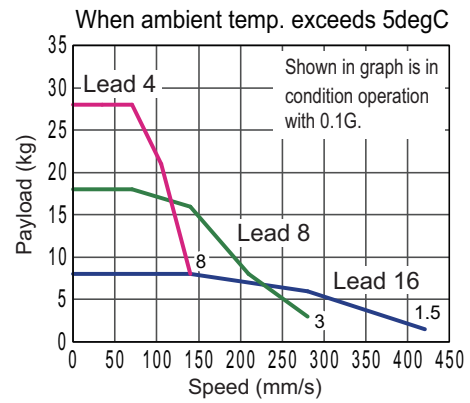

R A 8 C

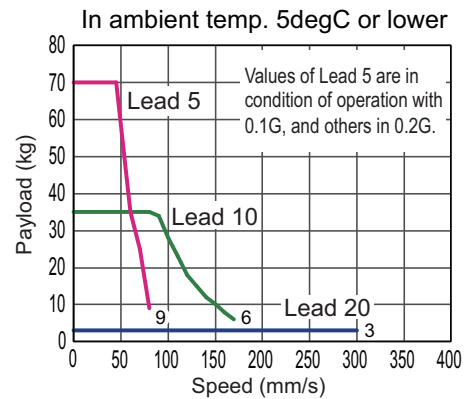
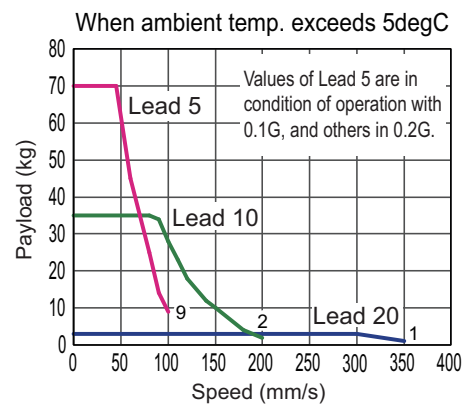
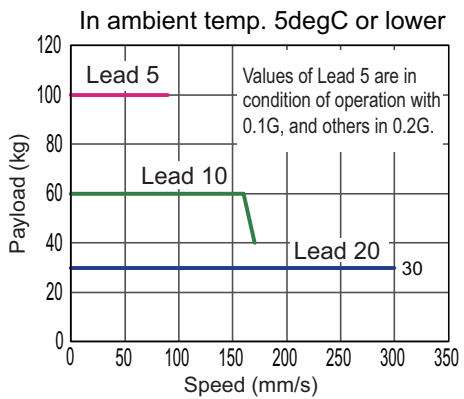
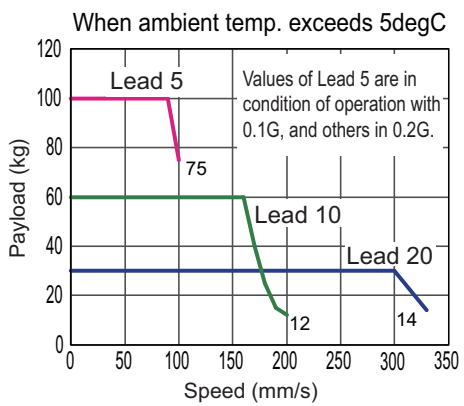

Correlation diagram of speed and payload for the RCP6W dust and drip proof rod type (High output effective / Motor-reversing type)

R A 4 R

R A 6 R

Horizontal installation

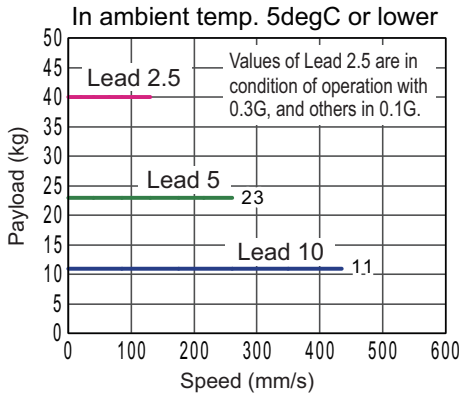
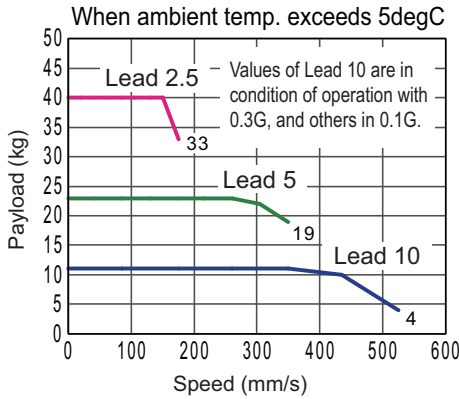

Vertical installation

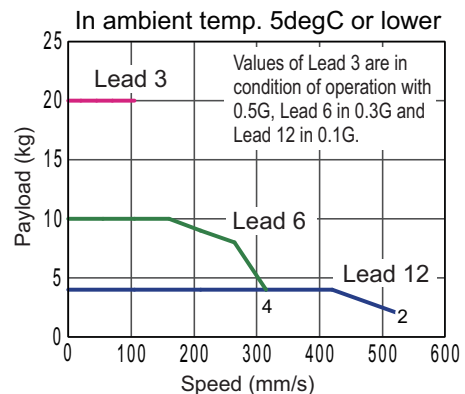
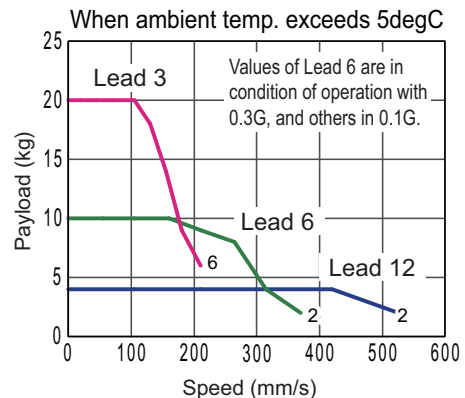
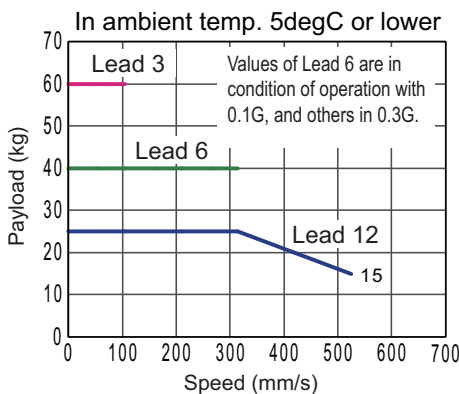
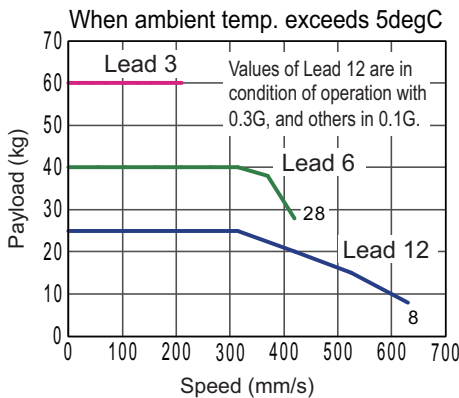
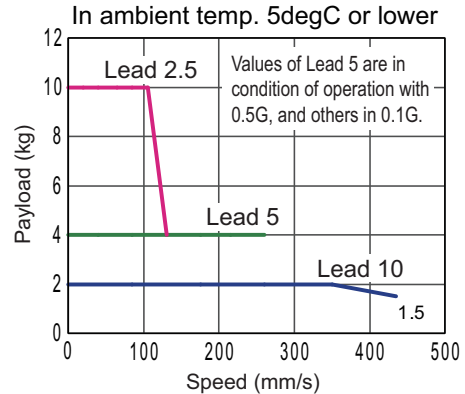
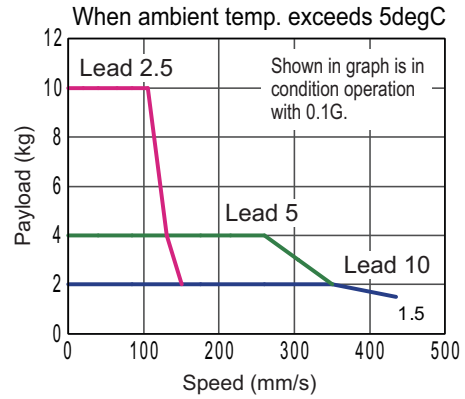

Chapter 9 Appendix

Correlation diagram of speed and payload for the RCP6W dust and drip proof rod type (High output effective / Motor-reversing type)

R A 7 R

Horizontal installation

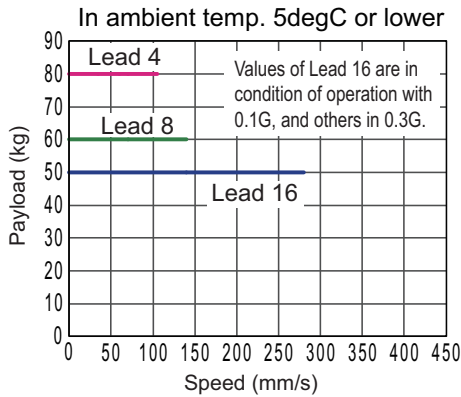
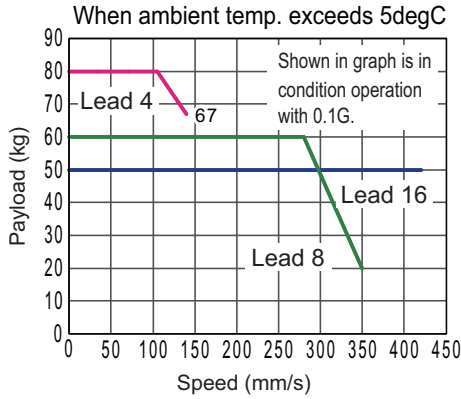

Vertical installation

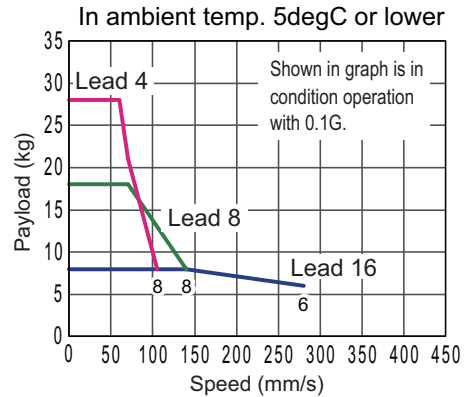
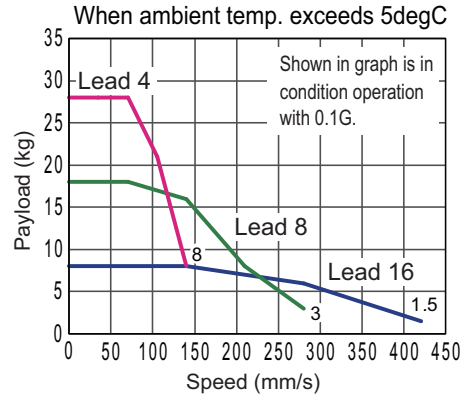

R A 8 R

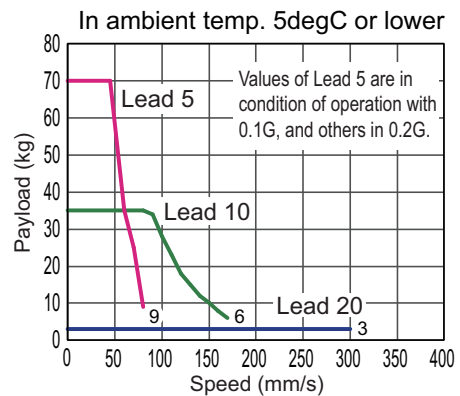
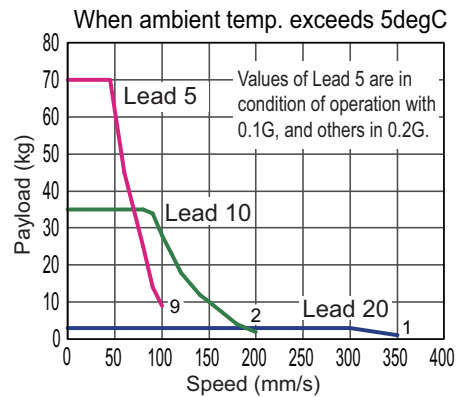
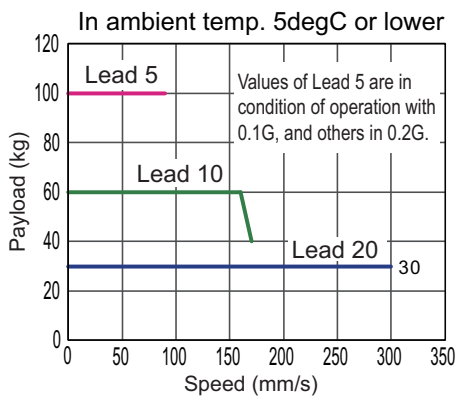
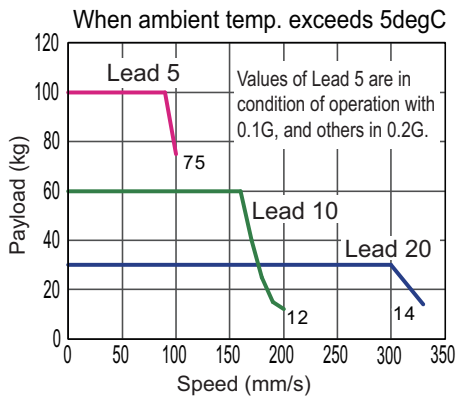

Correlation diagram of speed and payload for the RCP6W dust and drip proof radial cylinder type (High output effective)

RRA4C

RRA6C

Horizontal installation

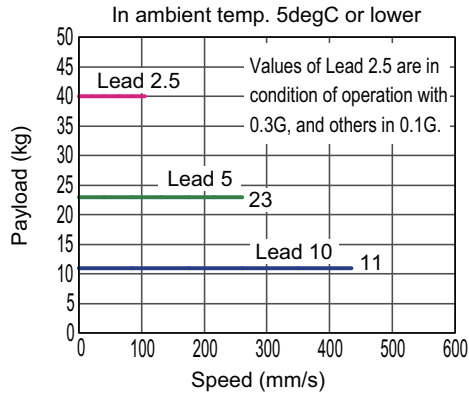
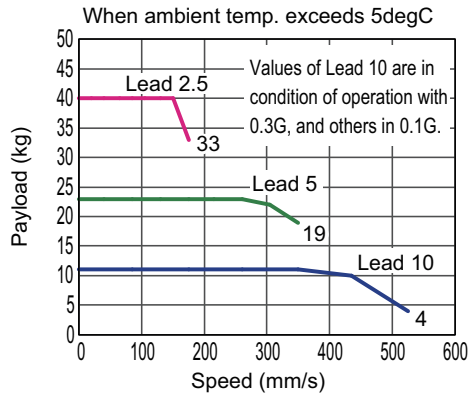

Vertical installation

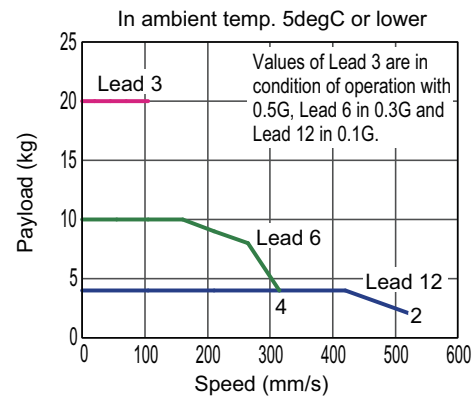
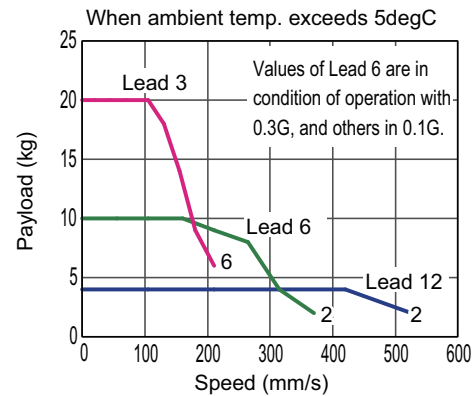
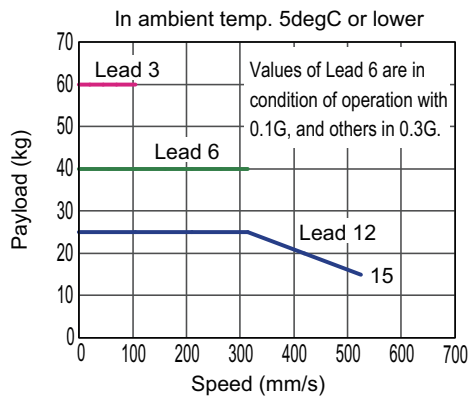
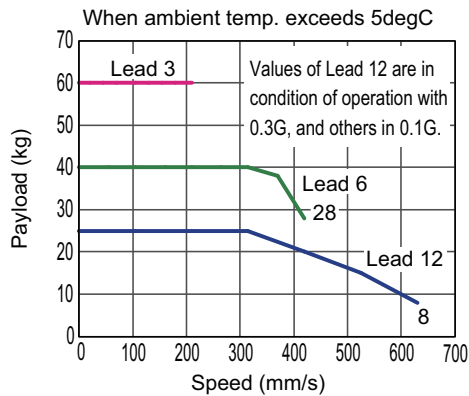
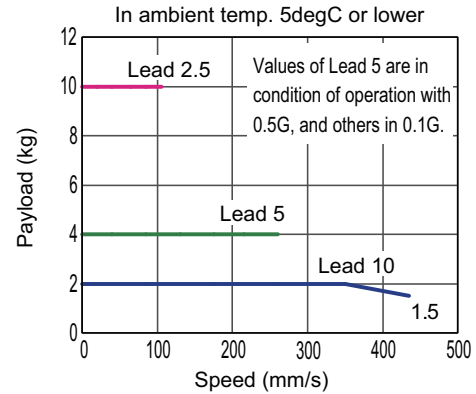
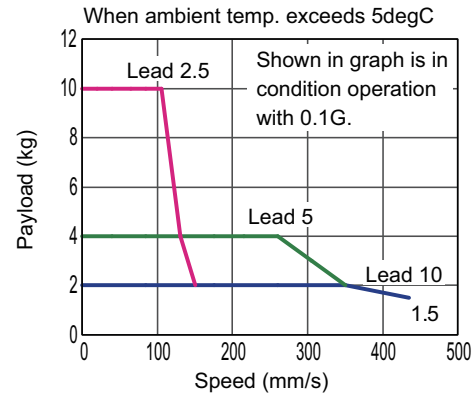

Correlation diagram of speed and payload for the RCP6W dust and drip proof radial cylinder type (High output effective)

RR7C

Horizontal installation

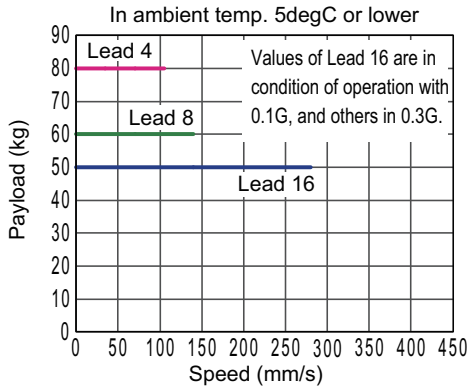
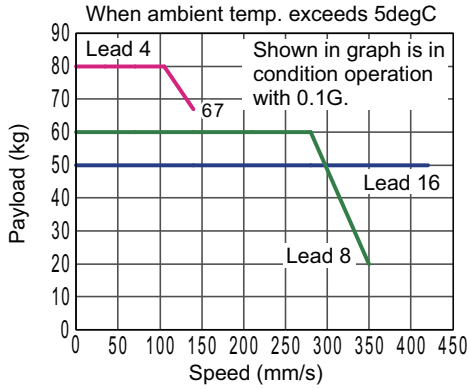

Vertical installation

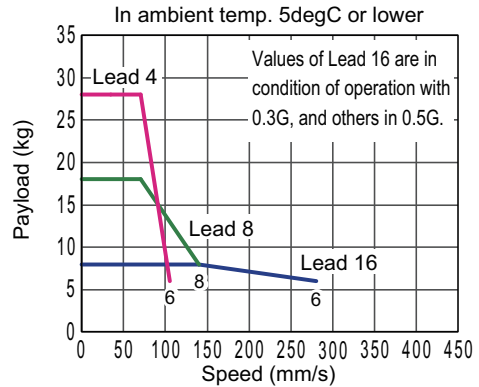
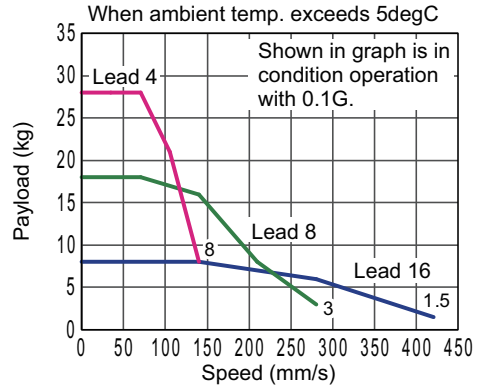

RR8C

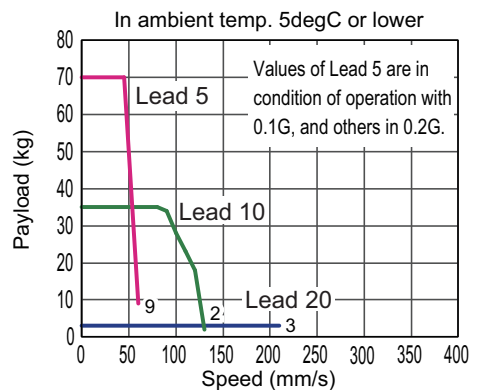
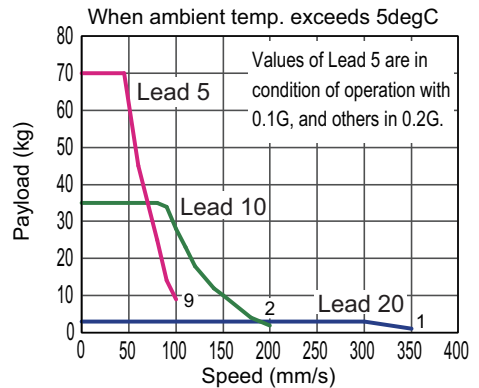
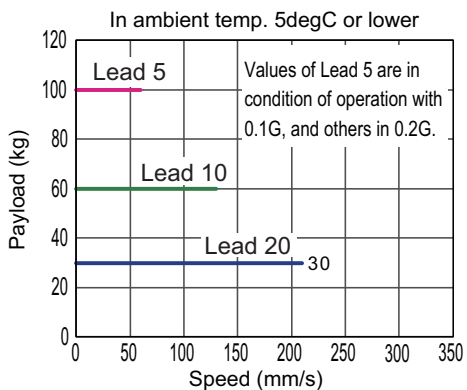
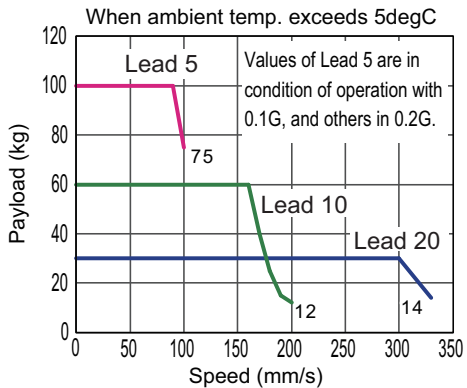

Correlation diagram of speed and payload for the RCP6W dust and drip proof radial cylinder type (High output effective / Motor-reversing type)

Horizontal installation

Vertical installation

RRA4R

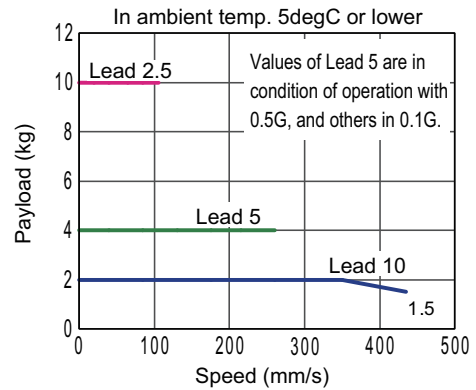
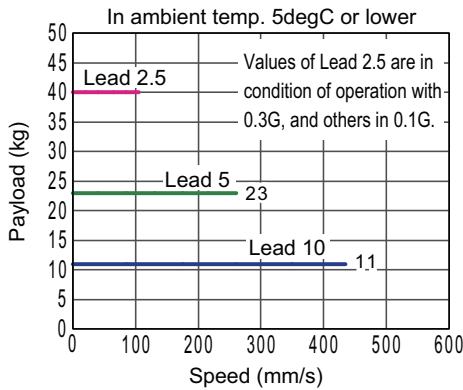
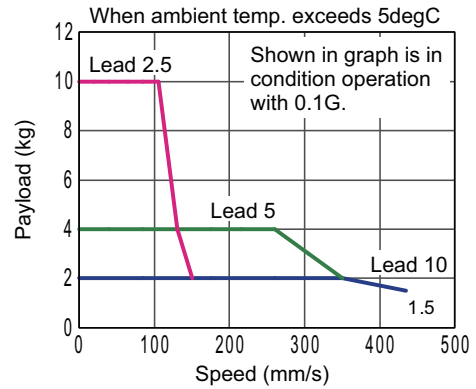
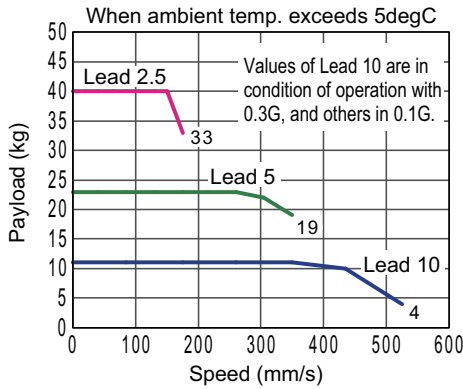

RRA6R

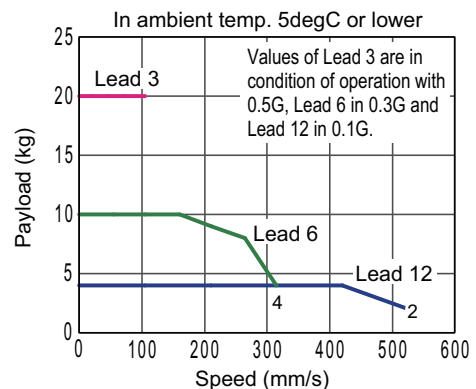
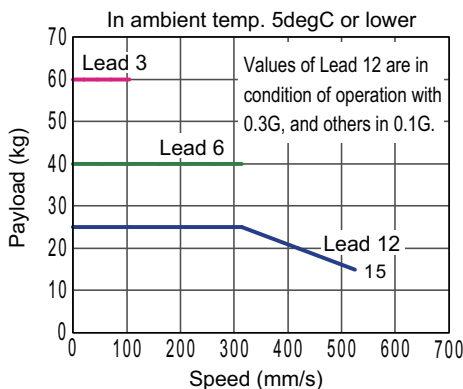
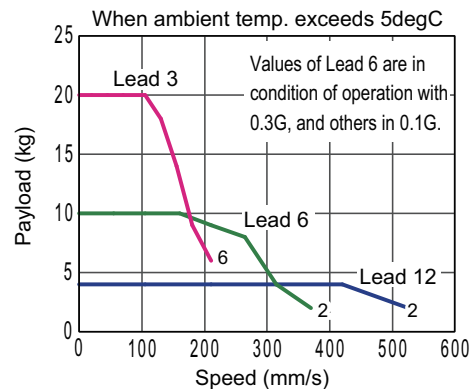
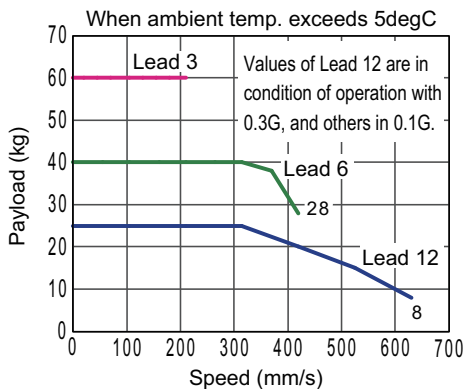

Correlation diagram of speed and payload for the RCP6W dust and drip proof radial cylinder type (High output effective / Motor-reversing type)

RRR7R

Horizontal installation

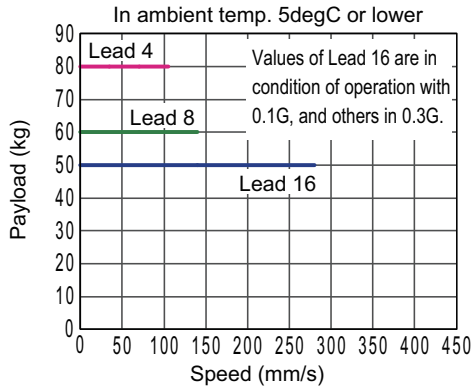
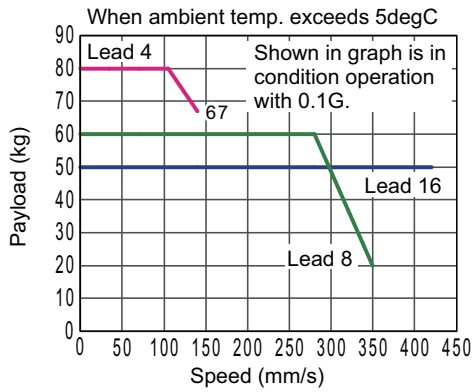

Vertical installation

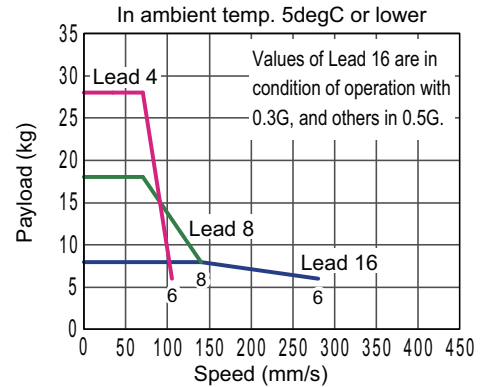
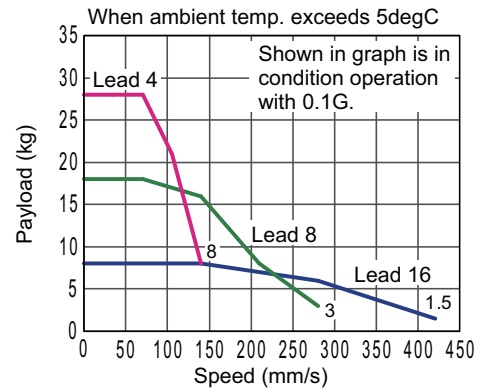

RRR8R

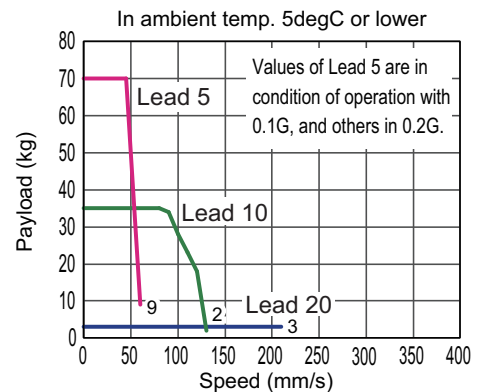
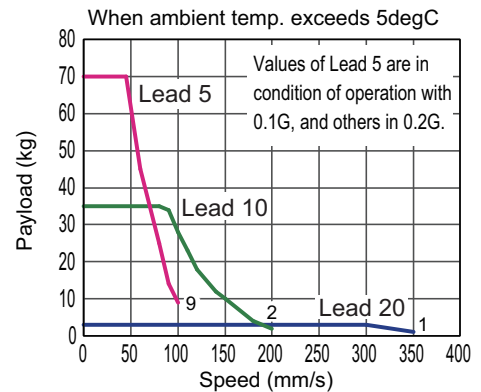
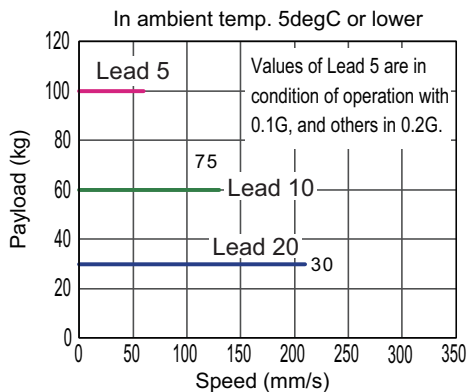
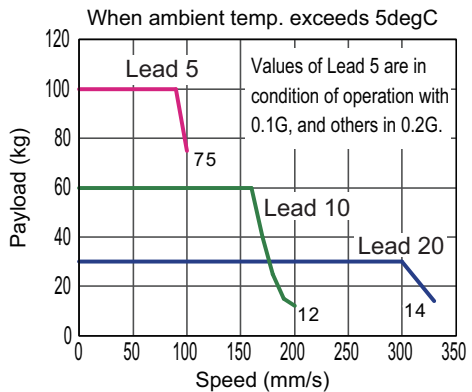

Correlation diagram of speed and payload for the RCP6W dust and drip proof wide radial cylinder type (High output effective)

W
R
A
1
0
C

W
R
A
1
2
C

Horizontal installation

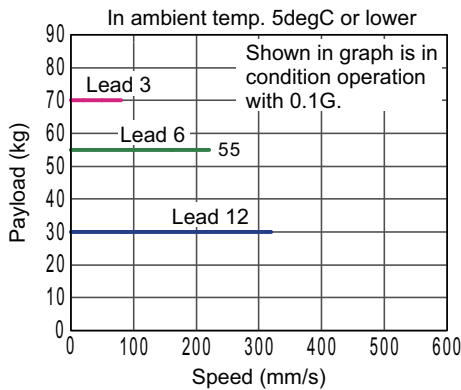
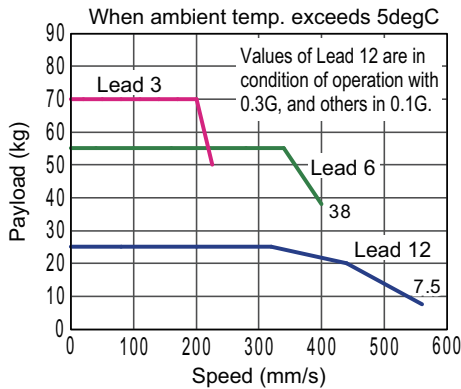
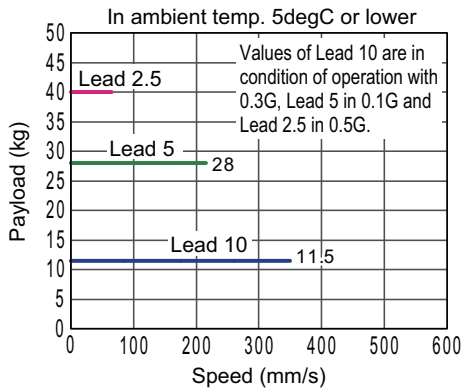
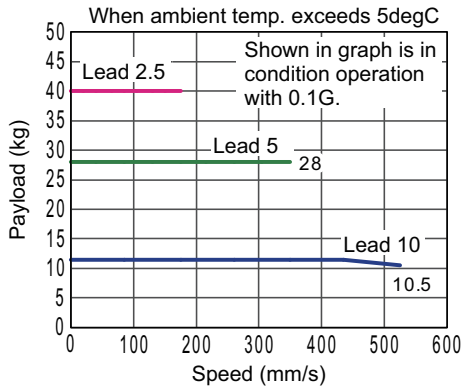

Vertical installation

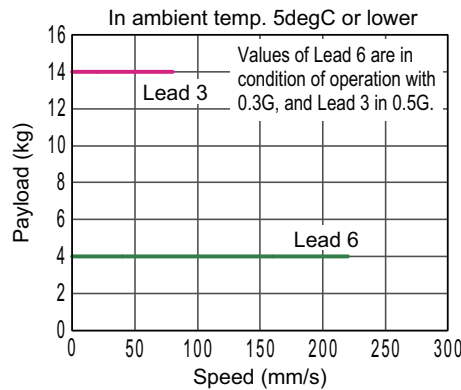
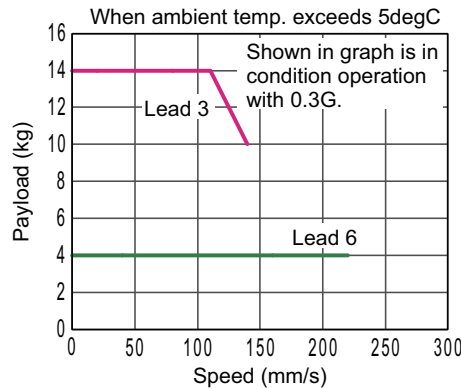
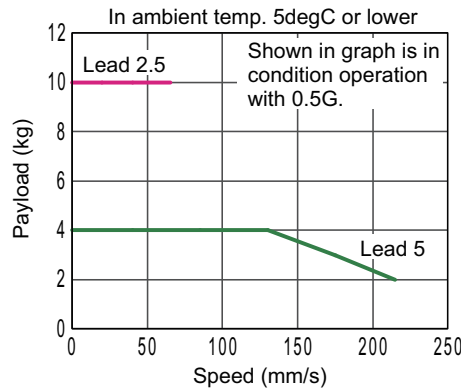
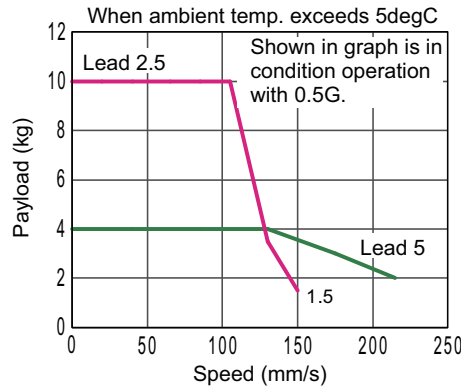

Correlation diagram of speed and payload for the RCP6W dust and drip proof wide radial cylinder type (High output effective)

Horizontal installation

Vertical installation

WRA 14 C

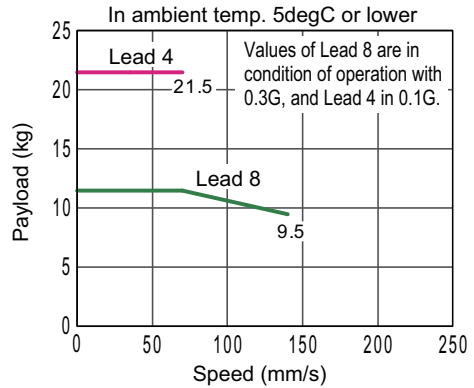
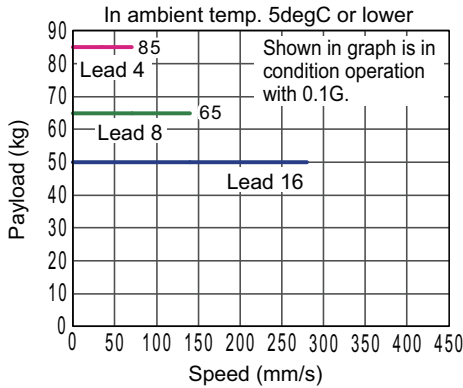
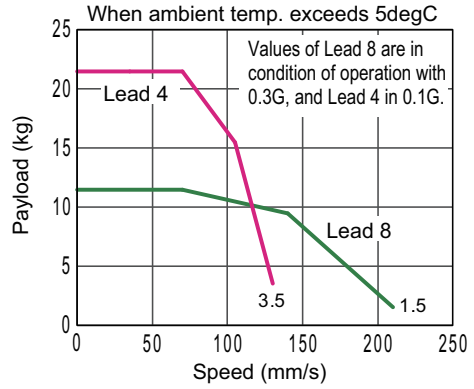
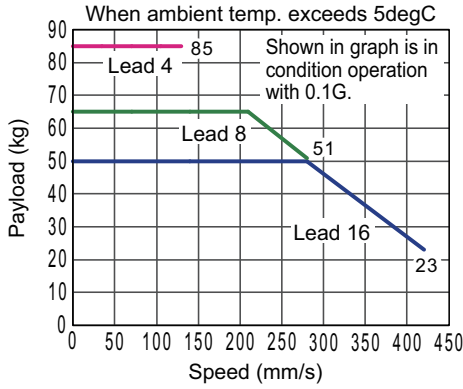

WRA 16 C

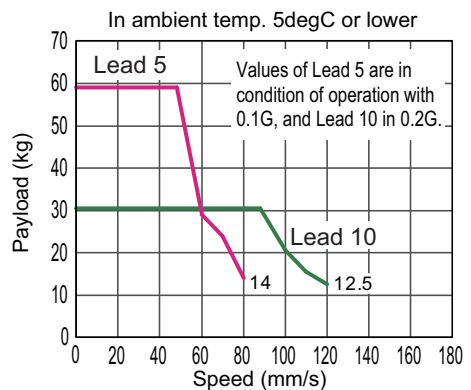
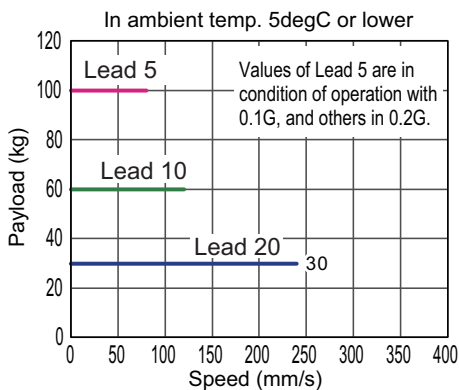
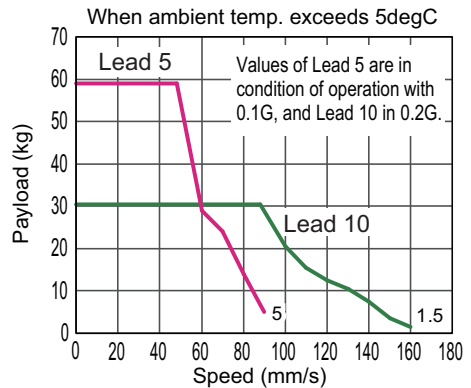
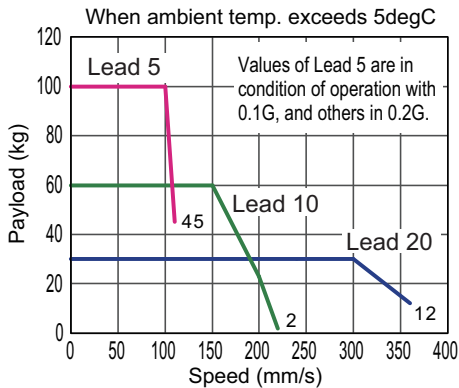

Correlation diagram of speed and payload for the RCP6W dust and drip proof wide radial cylinder type (High output effective / Motor-reversing type)

WRA10R

WRA12R

Horizontal installation

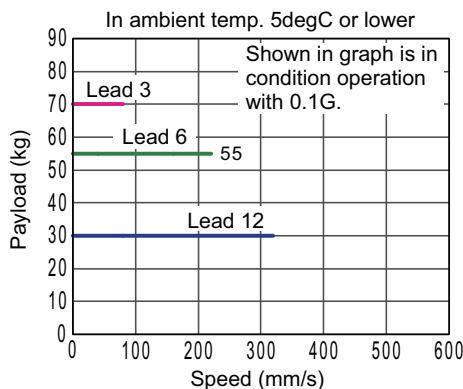
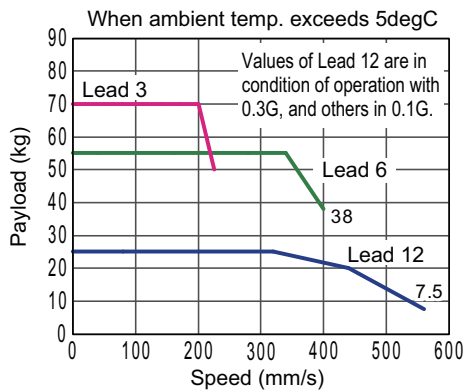
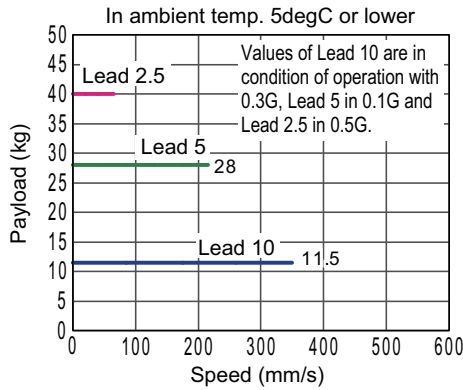
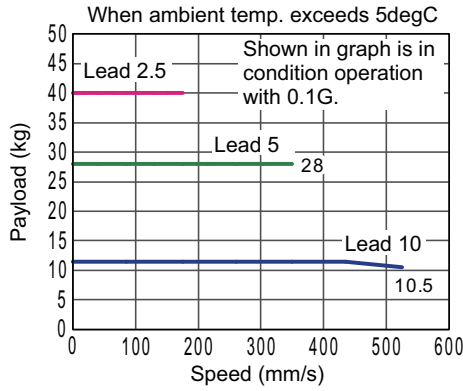

Vertical installation

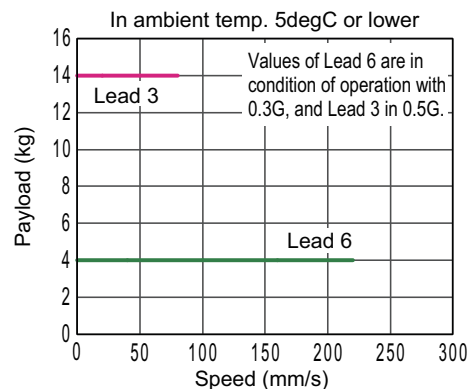
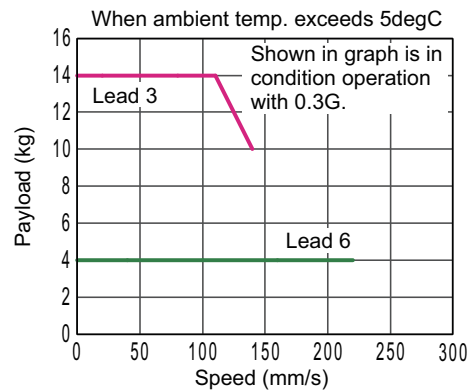
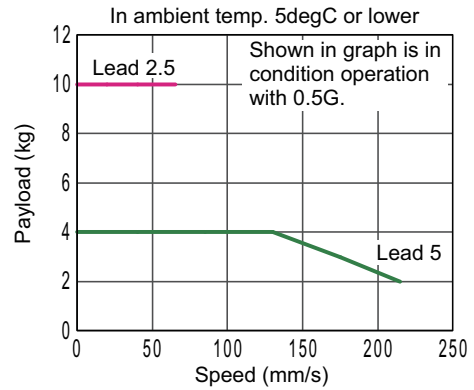
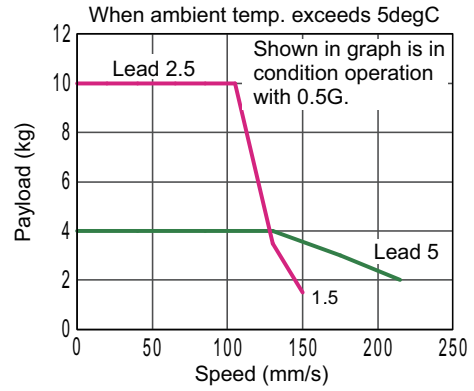

Correlation diagram of speed and payload for the RCP6W dust and drip proof wide radial cylinder type (High output effective / Motor-reversing type)

W
R
A
1
4
R

Horizontal installation

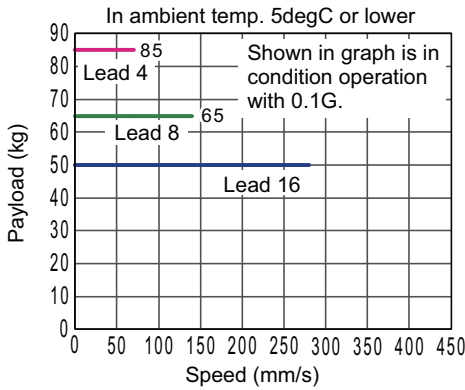
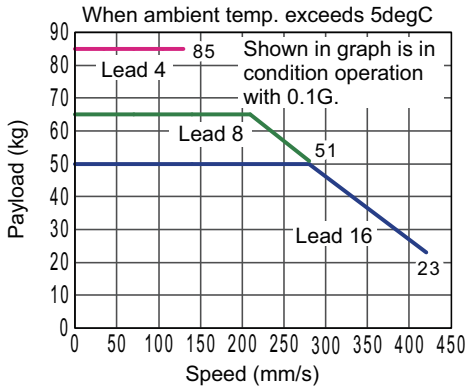

Vertical installation

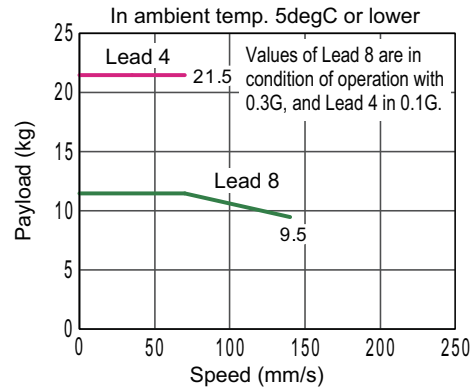
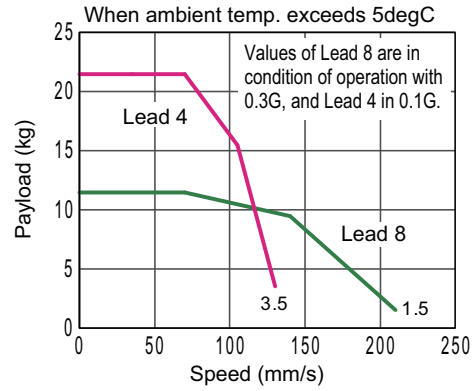

W
R
A
1
6
R

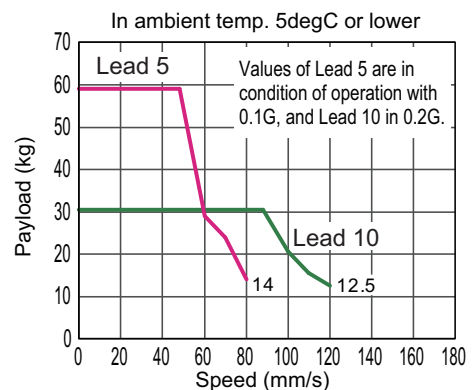
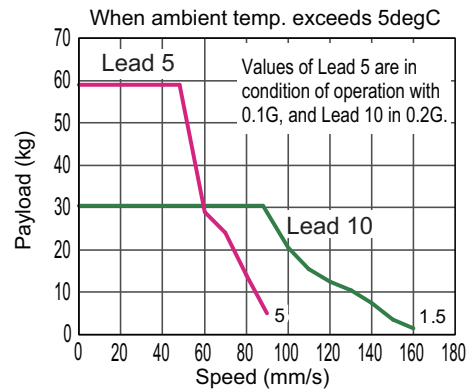
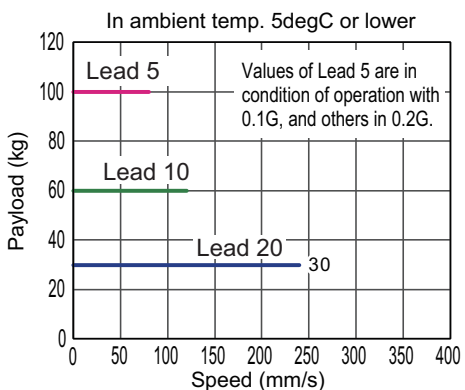
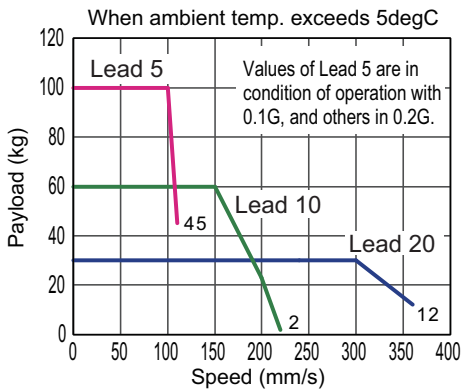

Correlation diagram of speed and payload for the RCP6 table type (High output effective)

Horizontal installation

Vertical installation

T A 4 C
(Single block type)

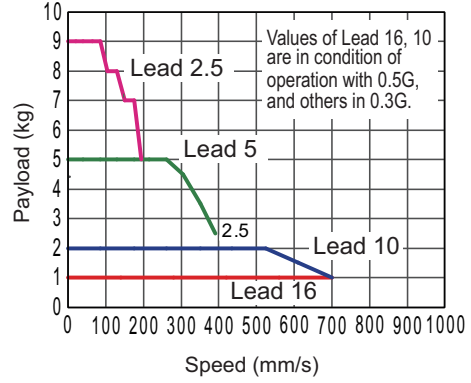
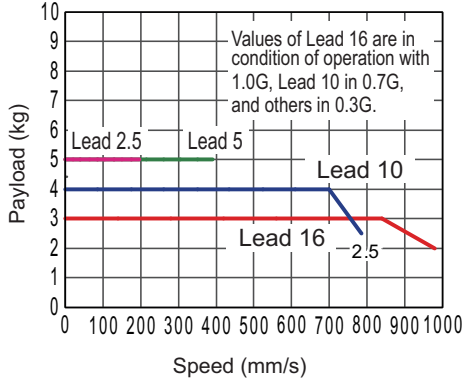

T A 6 C
(Single block type)

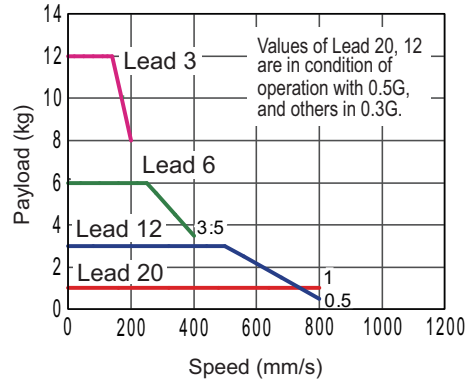
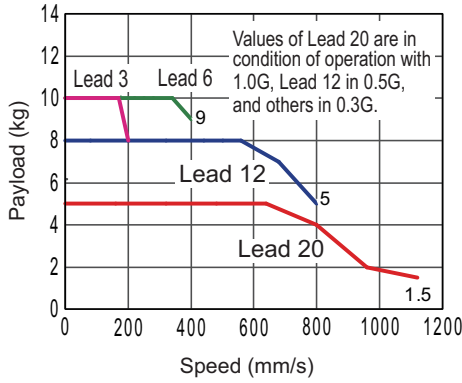

T A 7 C
(Single block type)

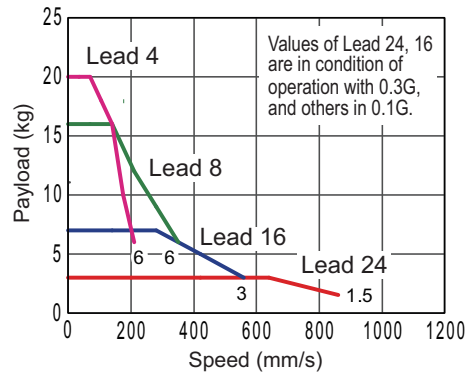
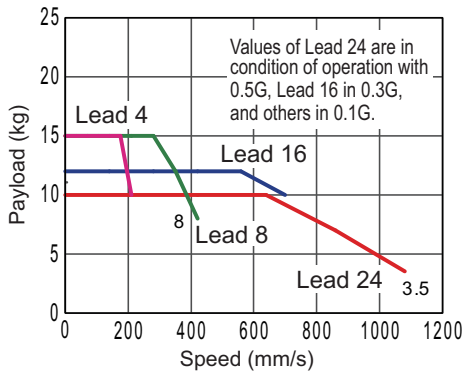

Chapter 9 Appendix

Correlation diagram of speed and payload for the RCP6 table type (High output effective / Motor-reversing type)

Horizontal installation

Vertical installation

T A 4 R
(Single block type)

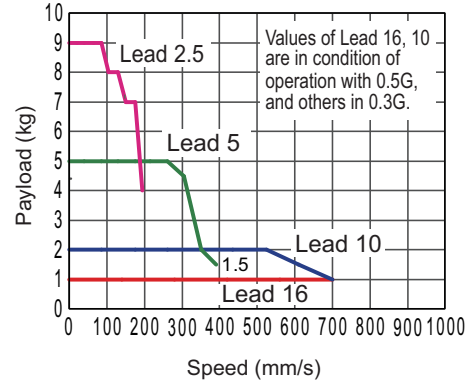
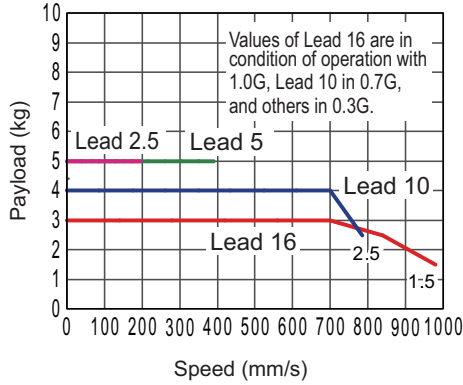

T A 6 R
(Single block type)

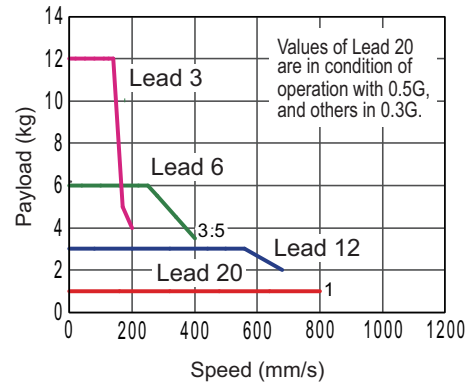
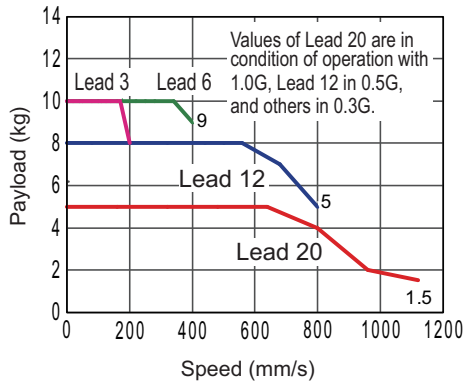

T A 7 R
(Single block type)

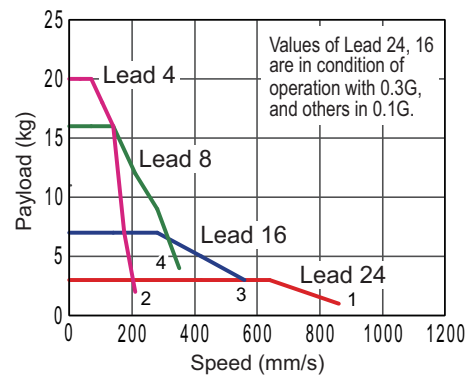
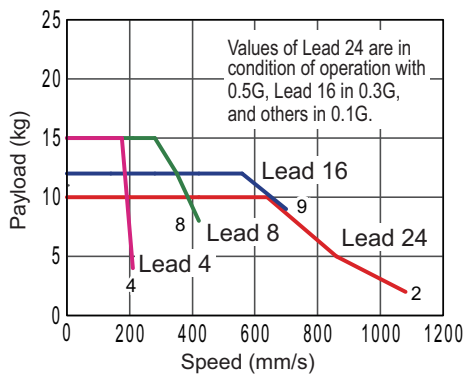

Correlation diagram of speed and payload for the RCP6 table type (High output effective)

Horizontal installation

Vertical installation

T A 4 C C (Double block type)

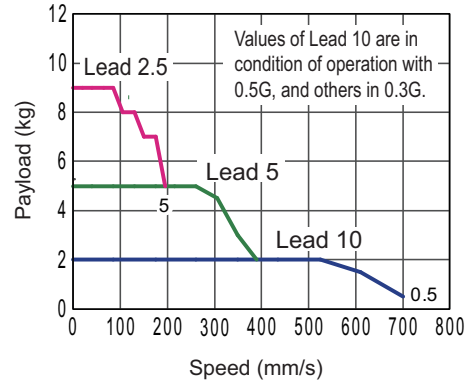
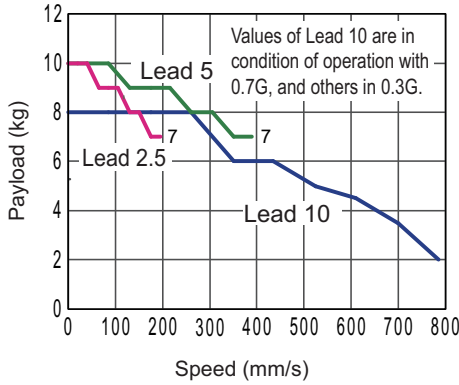

T A 6 C C (Double block type)

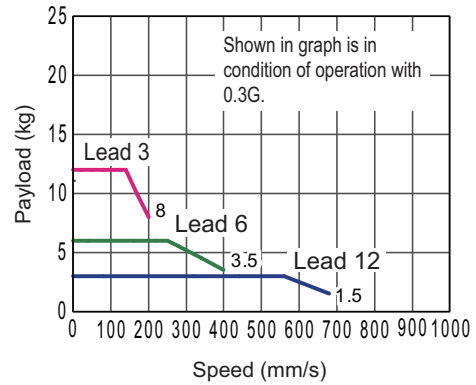
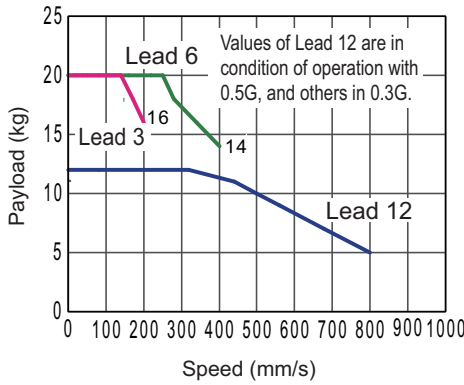

T A 7 C C (Double block type)

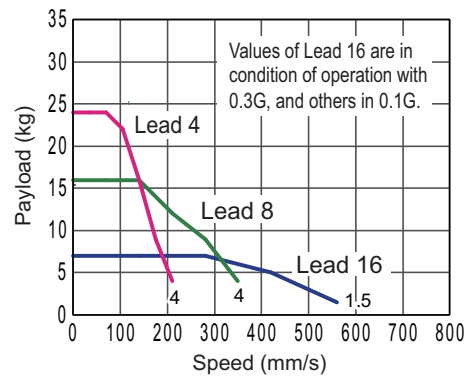
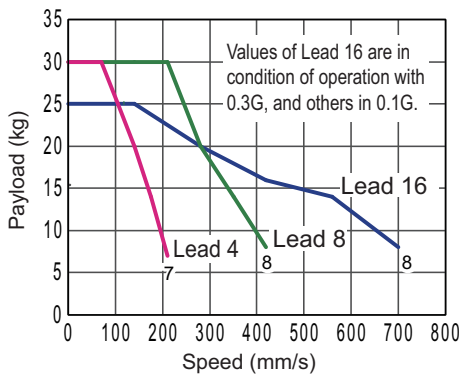

Correlation diagram of speed and payload for the RCP6 table type (High output effective / Motor-reversing type)

Horizontal installation

Vertical installation

T A 4 R R
(Double block type)

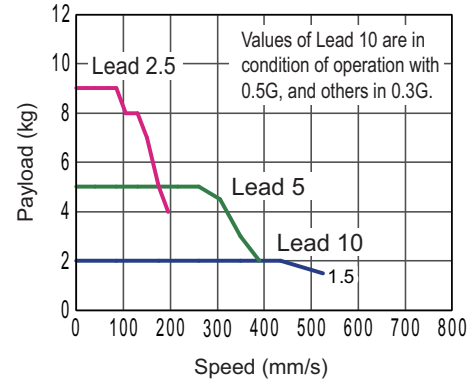
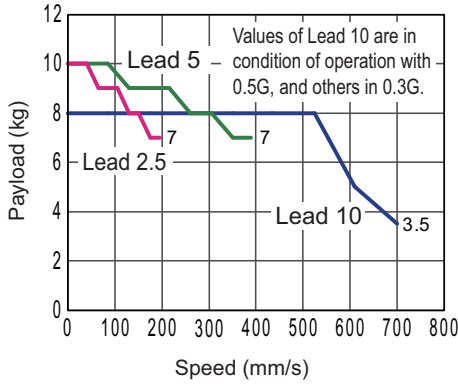

T A 6 R R
(Double block type)

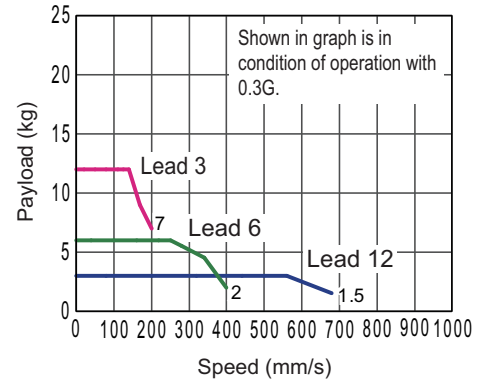
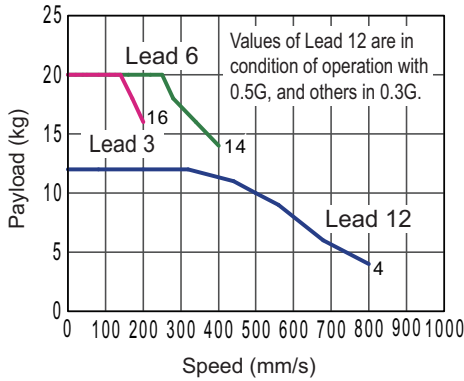

T A 7 R R
(Double block type)

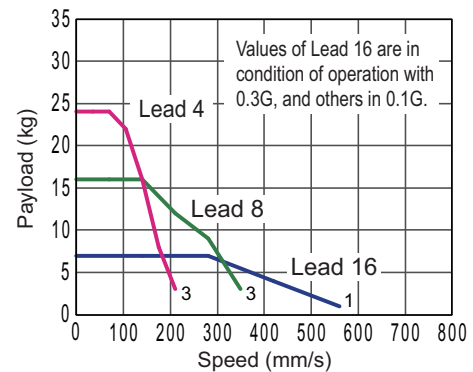
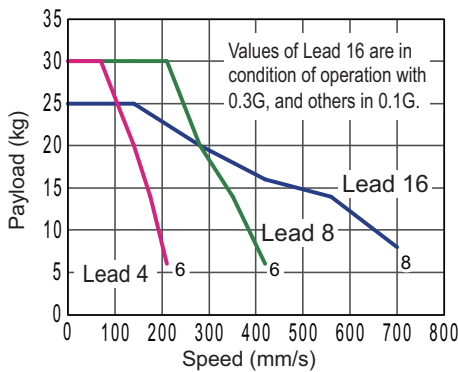

Correlation diagram of speed and payload for the RCP5 slider type (High output effective)

* Characteristics should be the same for Cleanroom type.

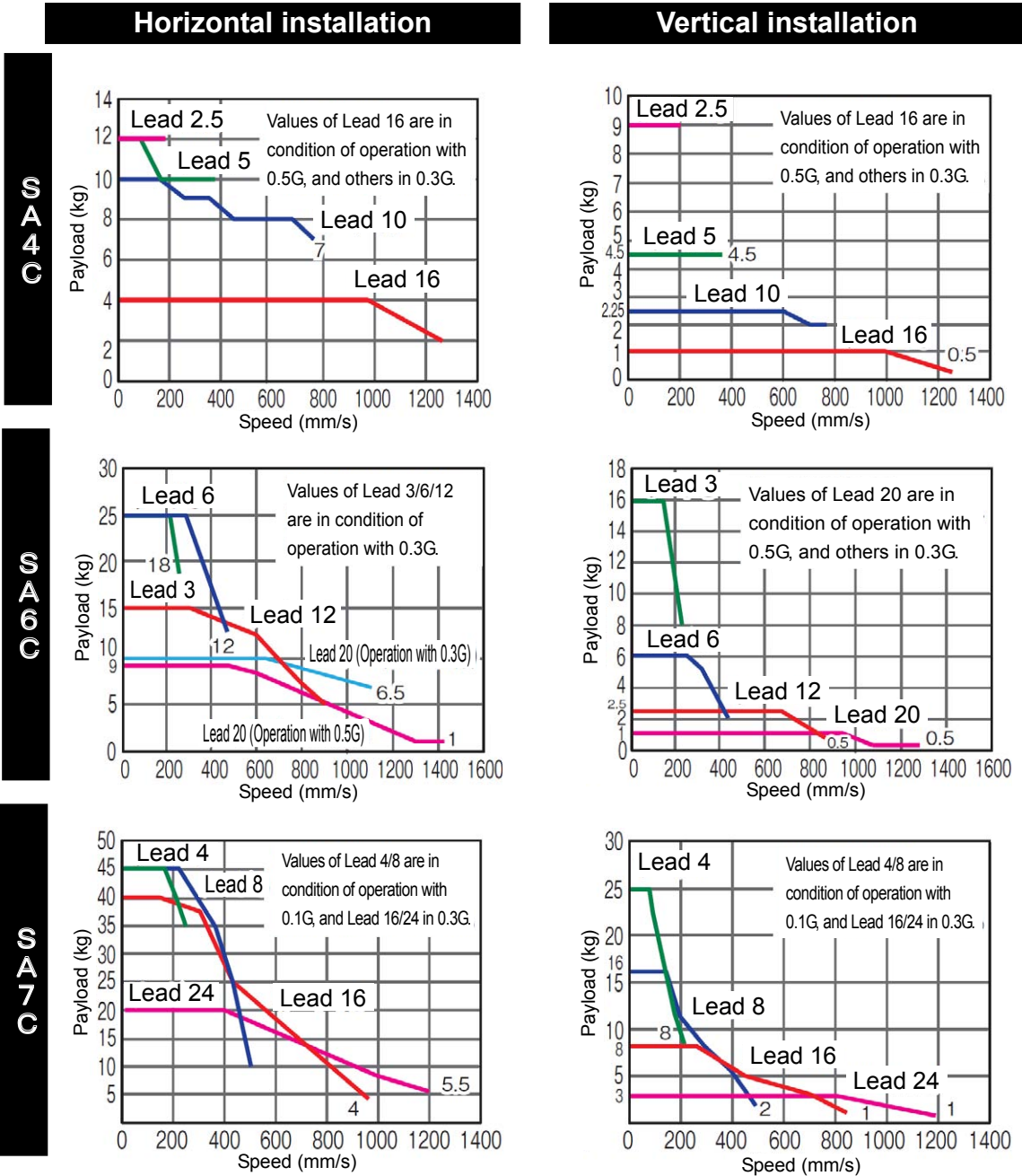

Correlation diagram of speed and payload for the RCP5 slider type (High output effective / Motor-reversing type)

Horizontal installation

Vertical installation

S4AS

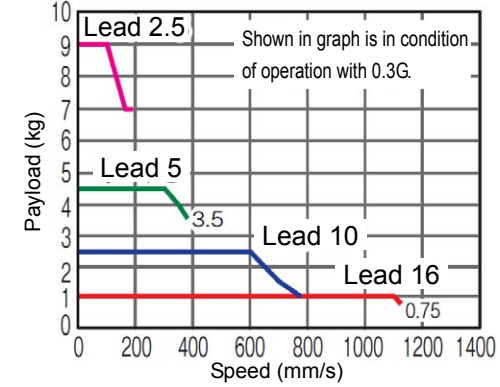
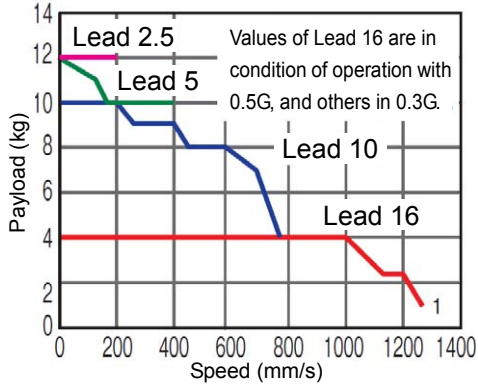

S6AS

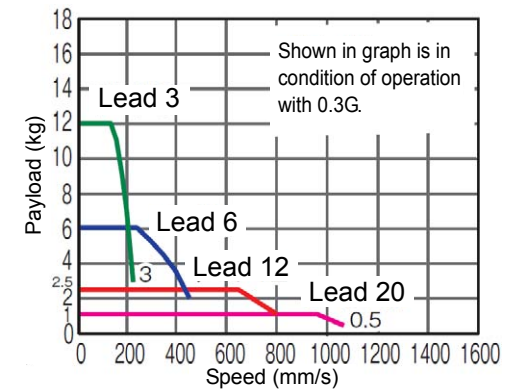
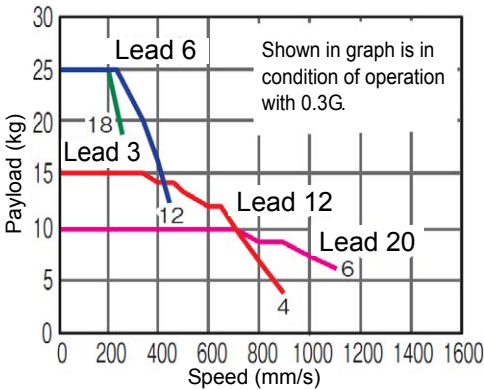

S7AS

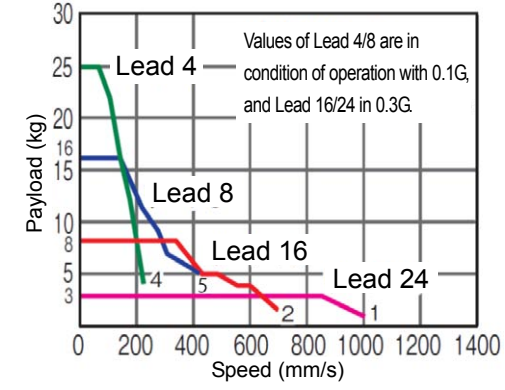
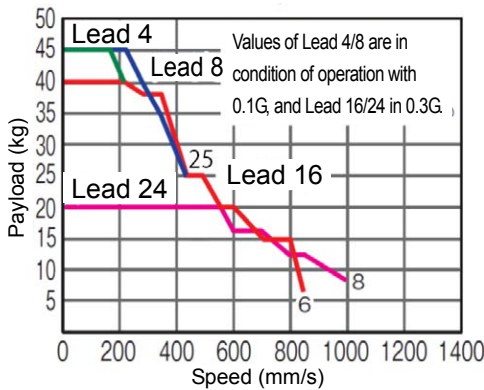

Correlation diagram of speed and payload for the RCP5 belt type (High output effective)

Horizontal installation (* Not Available for Vertical Installation)

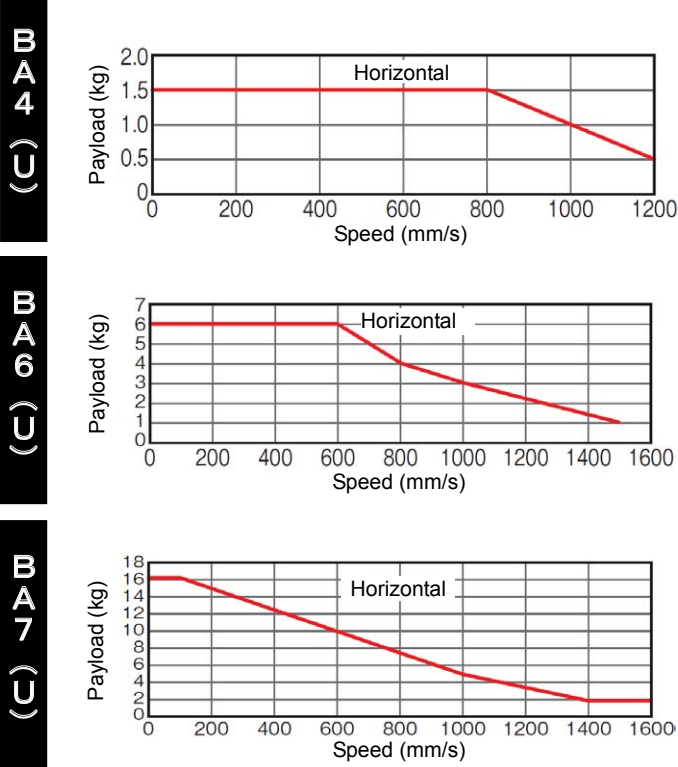

Correlation diagram of speed and payload for the RCP5 rod type (High output effective)

Horizontal installation Vertical installation

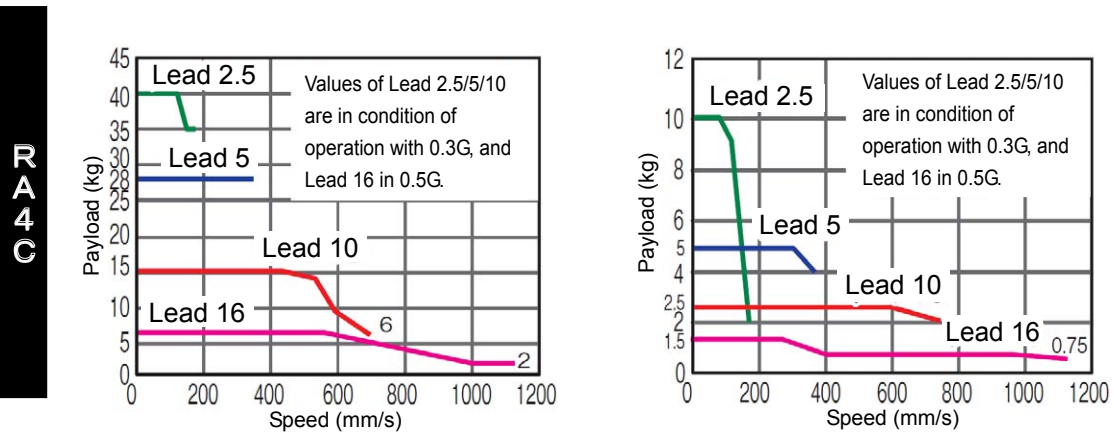

Correlation diagram of speed and payload for the RCP5 rod type (High output effective)

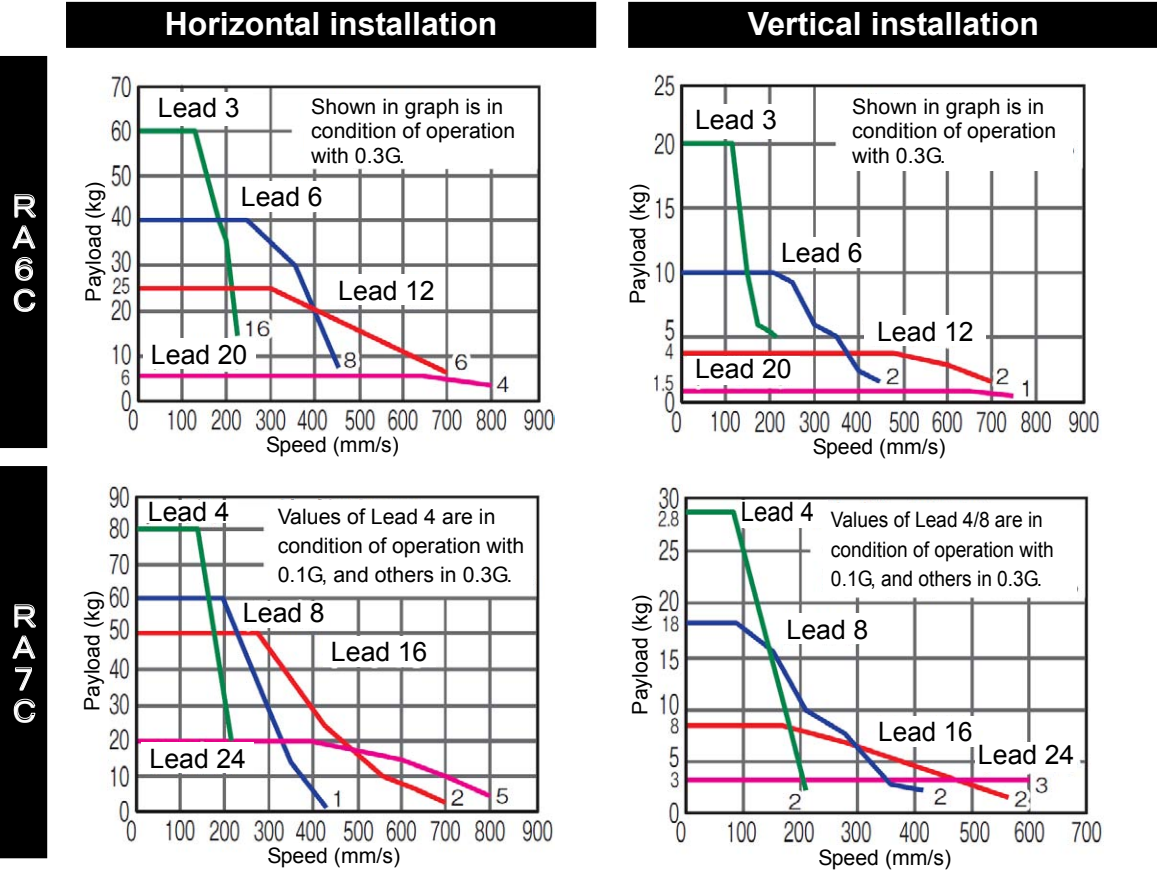

Correlation diagram of speed and payload for the RCP5 rod type

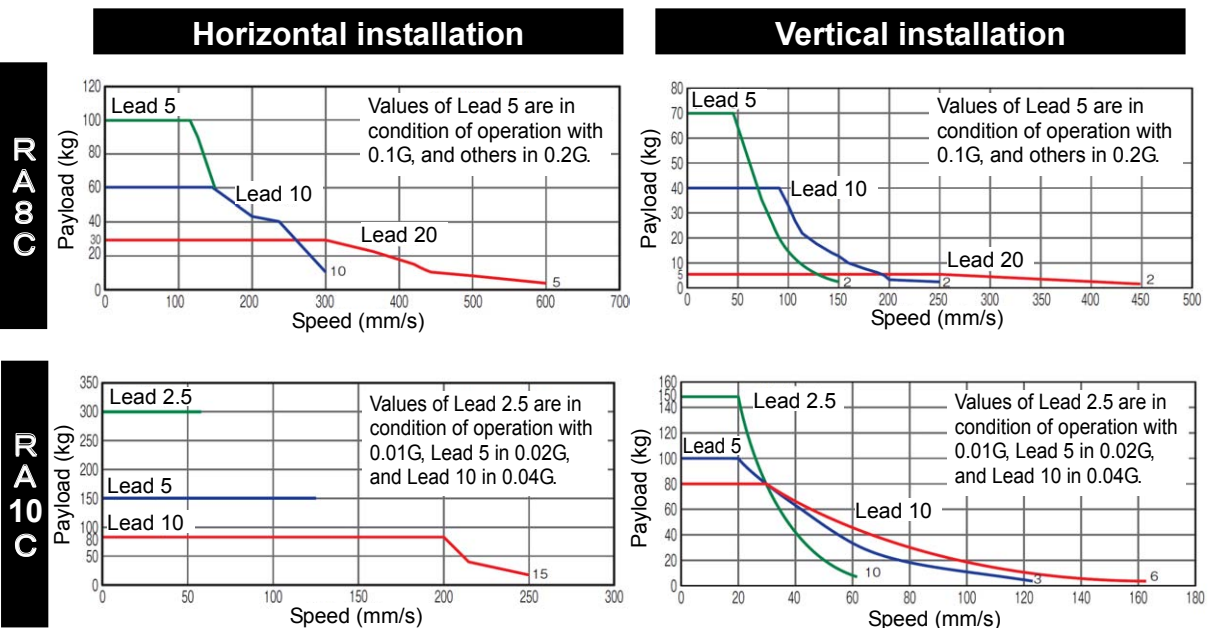

Correlation diagram of speed and payload for the RCP5 rod type (High output effective / Motor-reversing type)

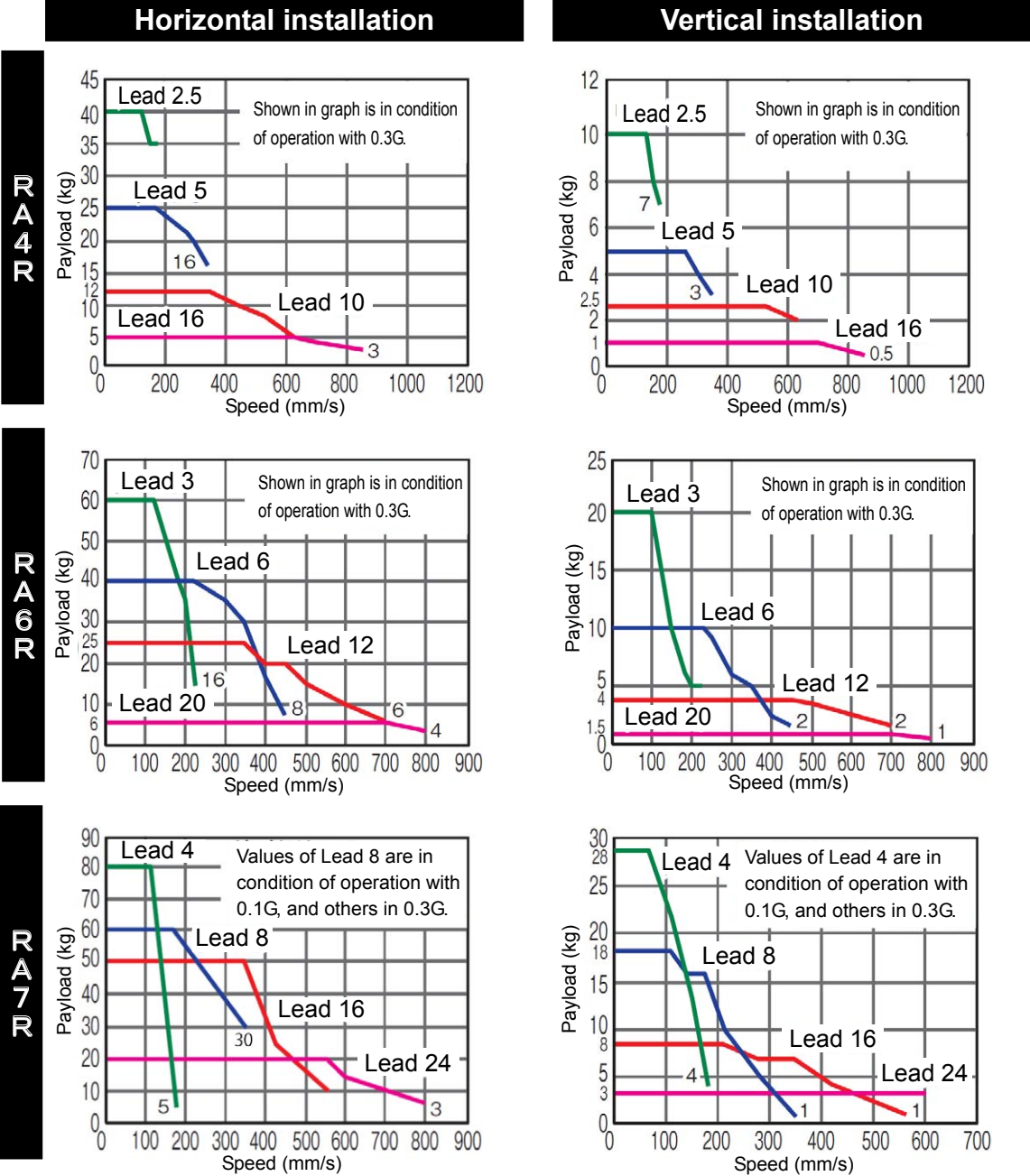

○ Correlation diagram of speed and payload for the RCP5 rod type (Motor-reversing type)

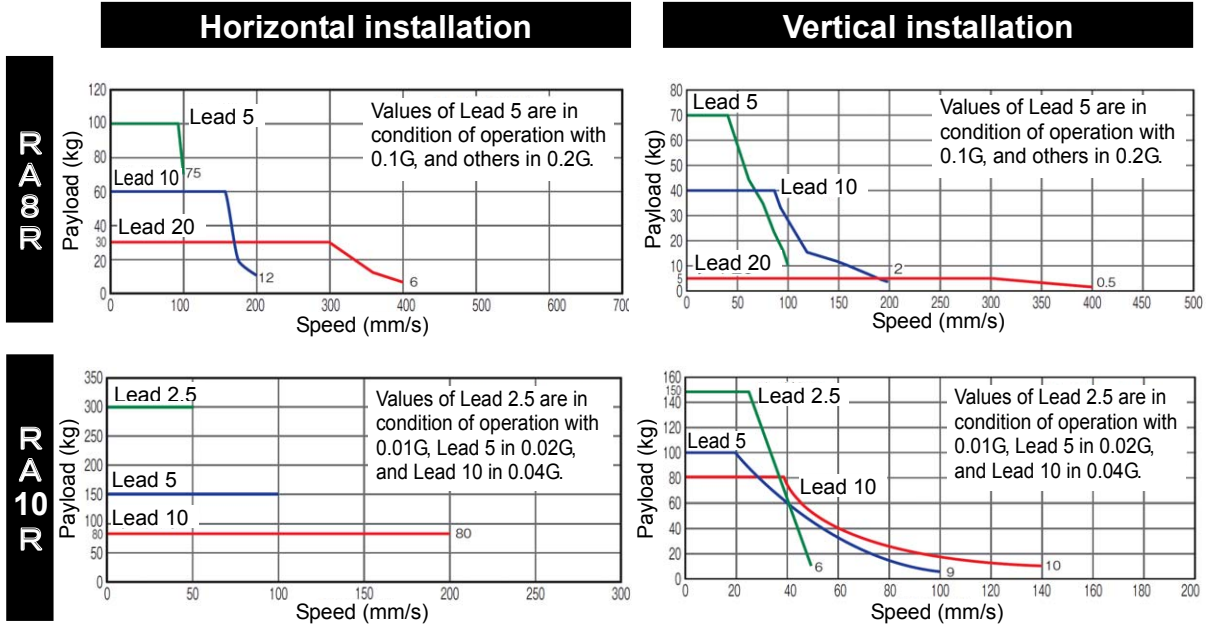

○ Correlation diagram of speed and payload for the RCP5W dust and drip proof rod type (High output effective)

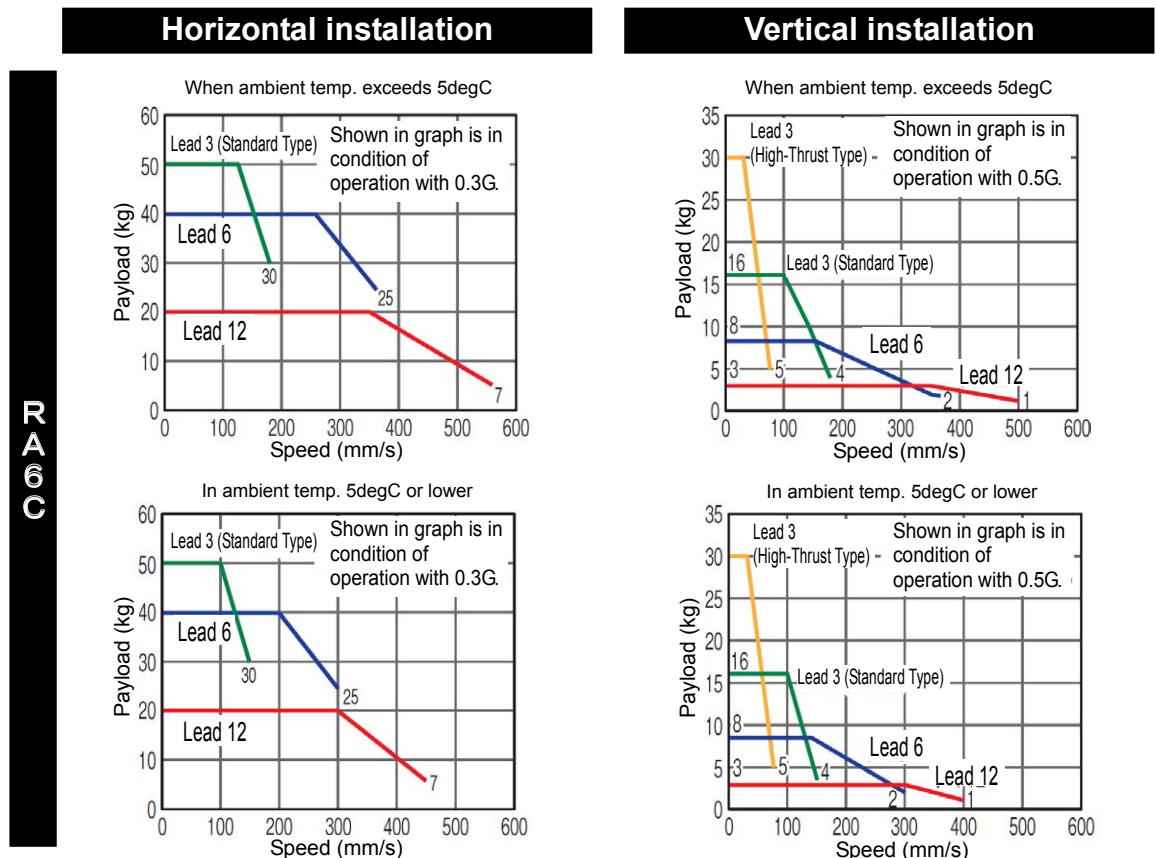

Correlation diagram of speed and payload for the RCP5W dust and drip proof rod type (High output effective)

R A 7 C

Horizontal installation

Vertical installation

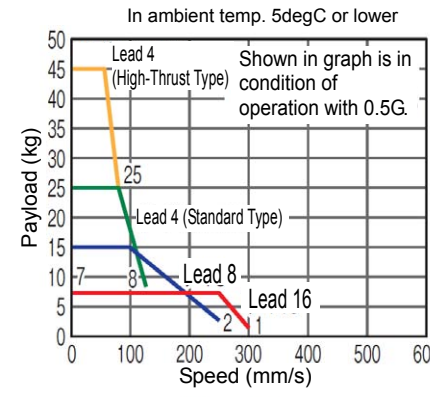
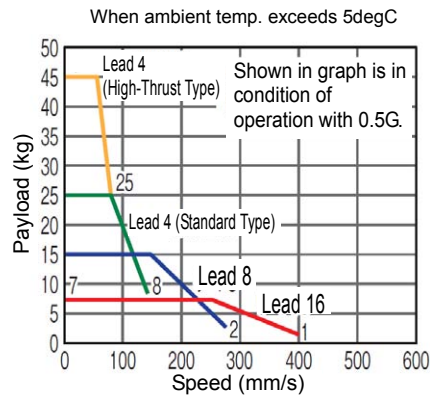
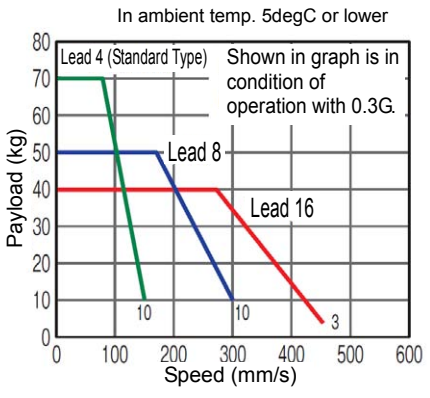
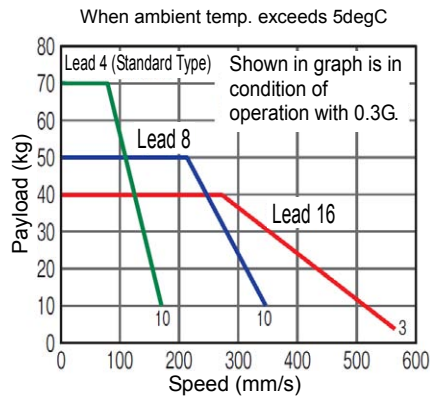

Chapter 9 Appendix

Correlation diagram of speed and payload for the RCP5W dust and drip proof rod type

Horizontal installation Vertical installation

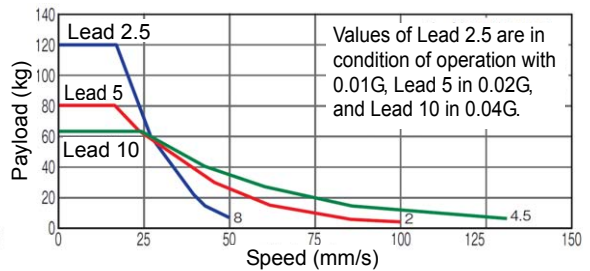
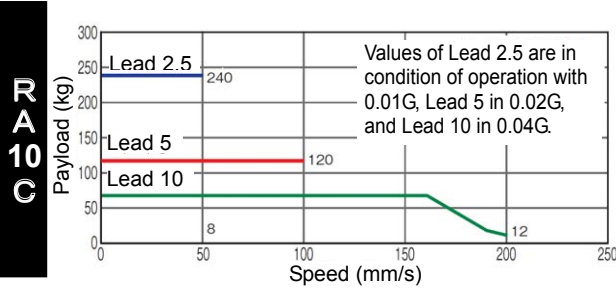
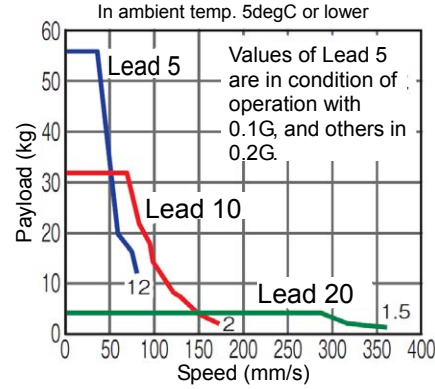
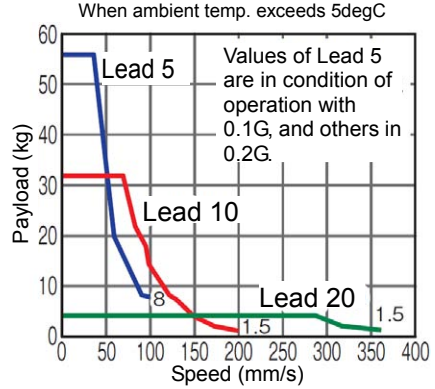
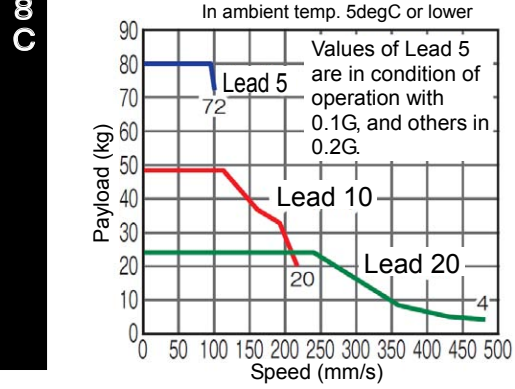
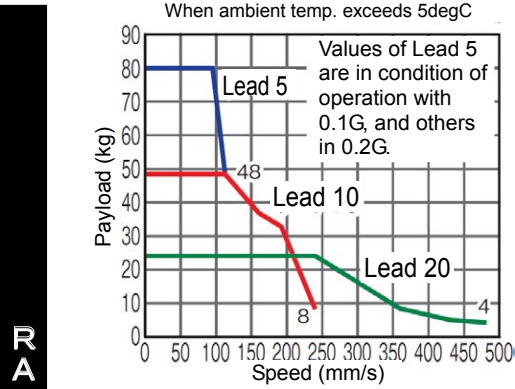

Correlation diagram of speed and payload for the RCP4 slider type (High output effective)

* Characteristics should be the same for Cleanroom type.

Horizontal installation

Vertical installation

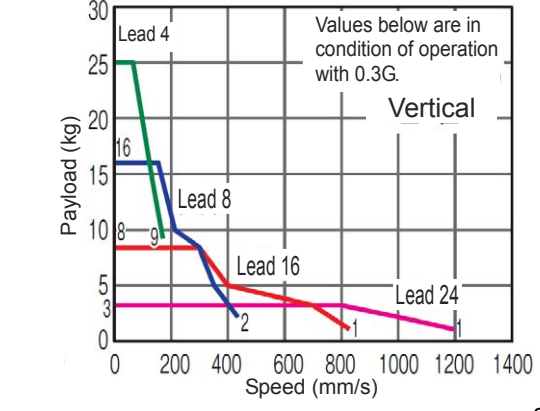
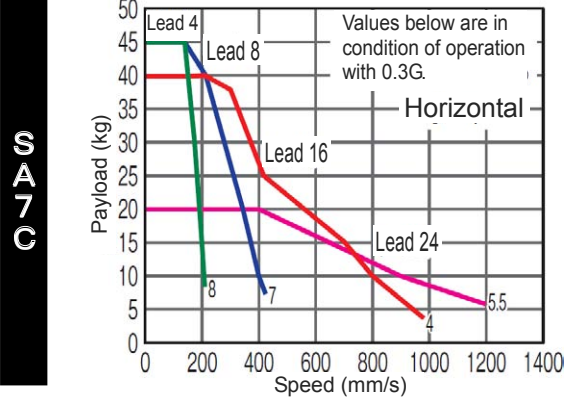
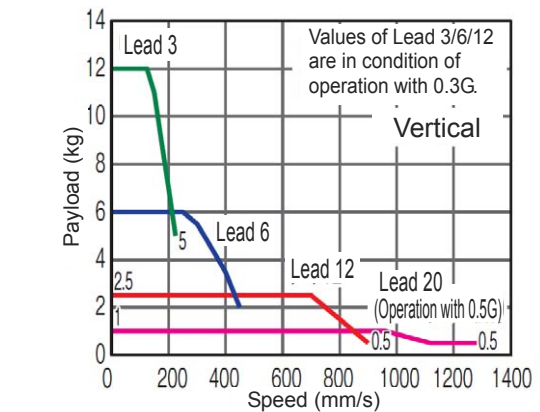
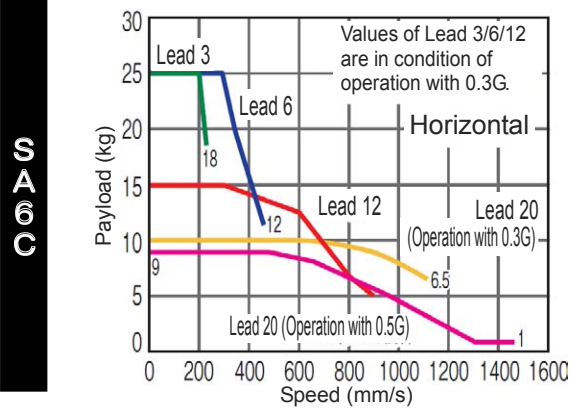
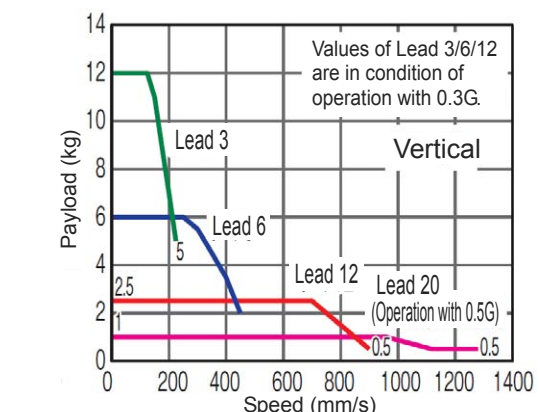
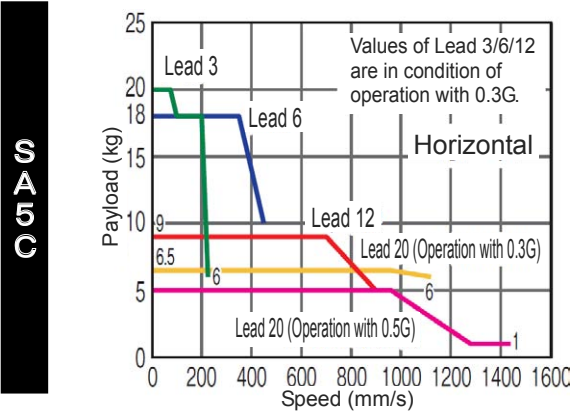
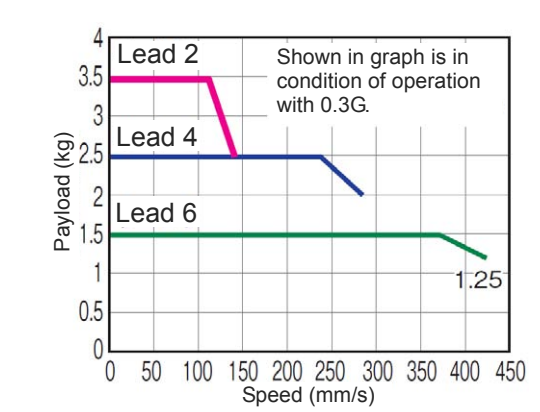
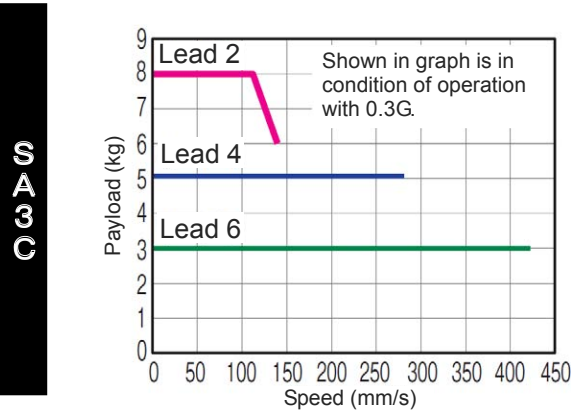

Correlation diagram of speed and payload for the RCP4 slider type (High output effective / Motor-reversing type)

S A 3 R

Horizontal installation

Vertical installation

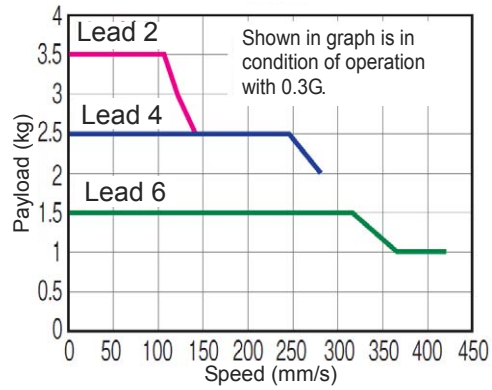
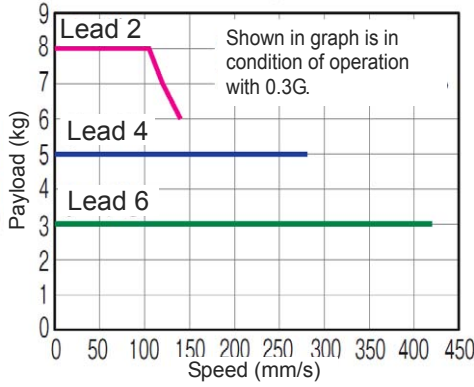

S A 5 R

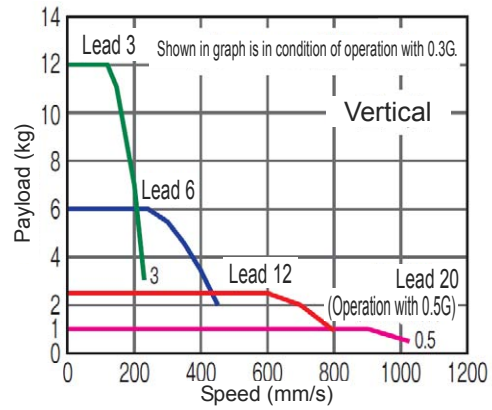
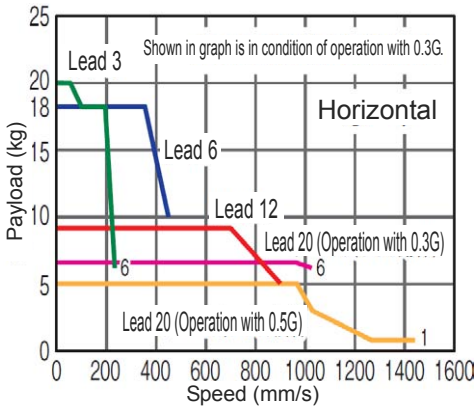

S A 6 R

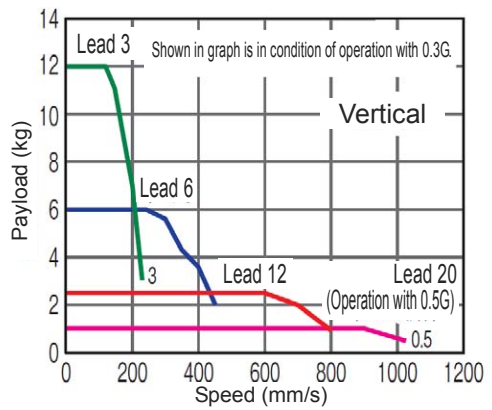
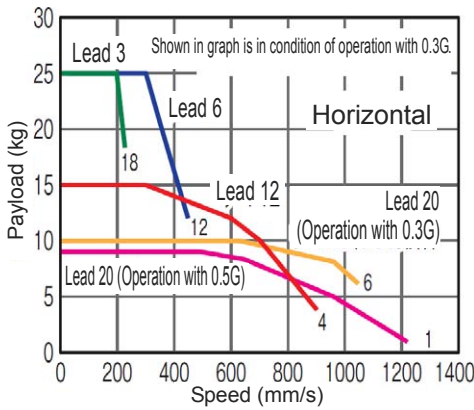

S A 7 R

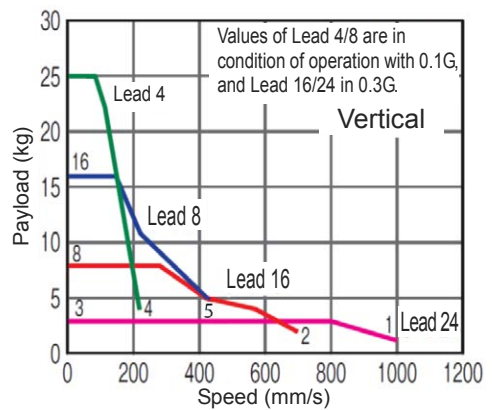
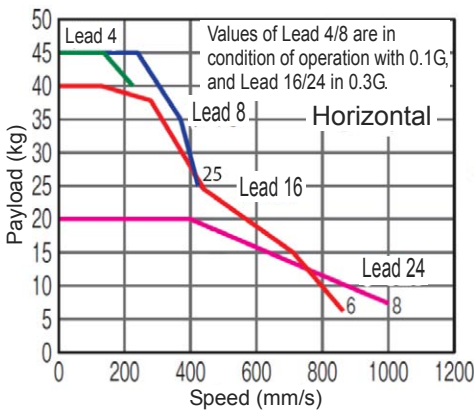

Correlation diagram of speed and payload for the RCP4W dust and drip proof slider type

* The payload of the slider type in RCP4W series should be constant even if the velocity gets increased.

Note that, however, the payload decreases when acceleration gets increased.

Supported on Both Ends

Supported on One End

S5AS

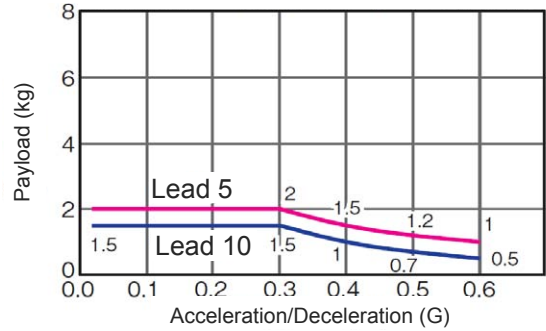
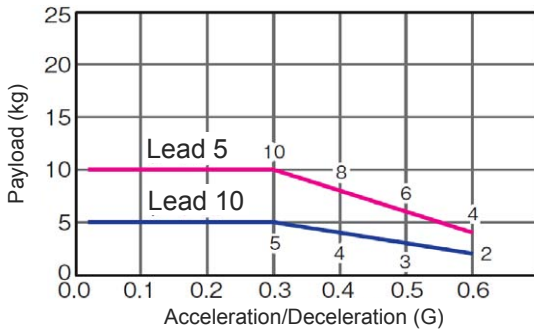

S6AS

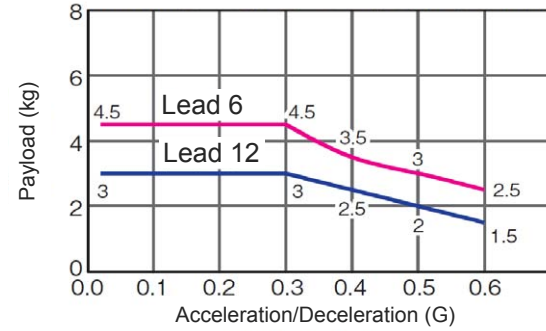
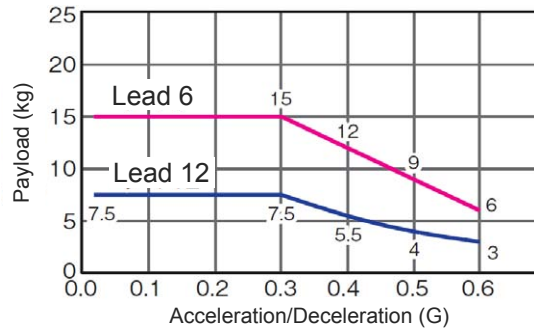

S7AS

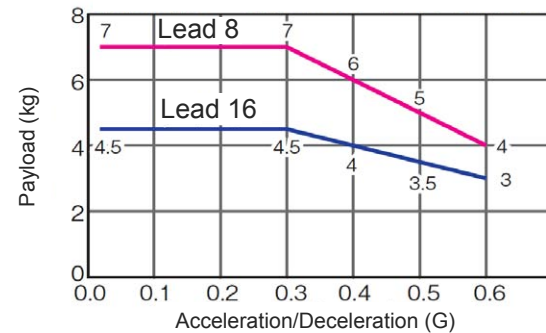
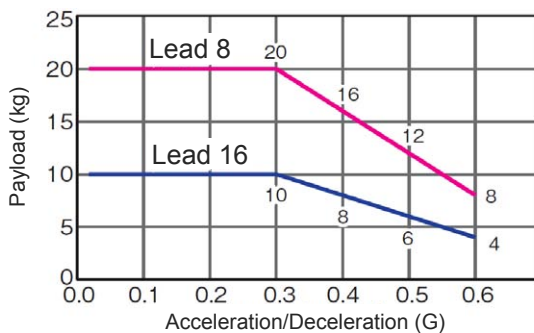

Correlation diagram of speed and payload for the RCP4 rod type (High output effective)

Horizontal installation

Vertical installation

R33R

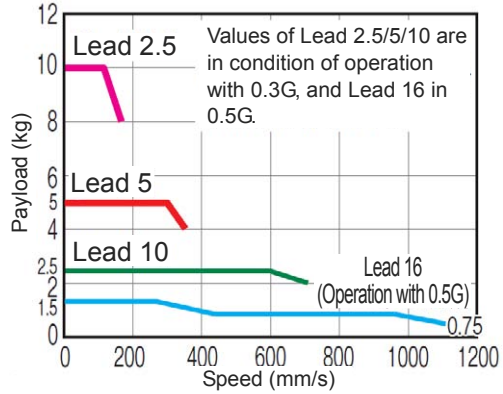
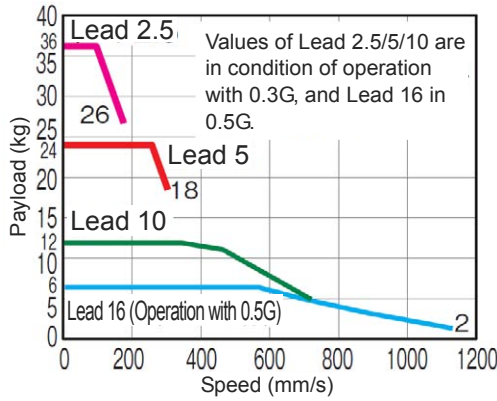

R55R

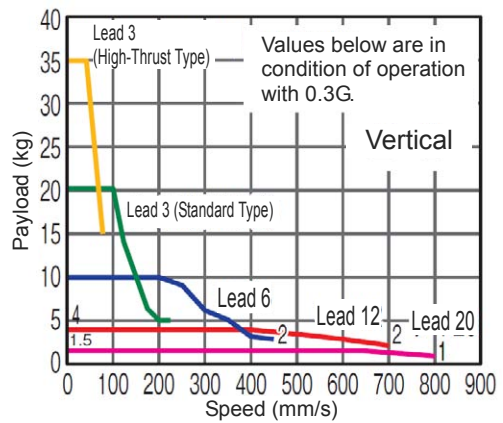
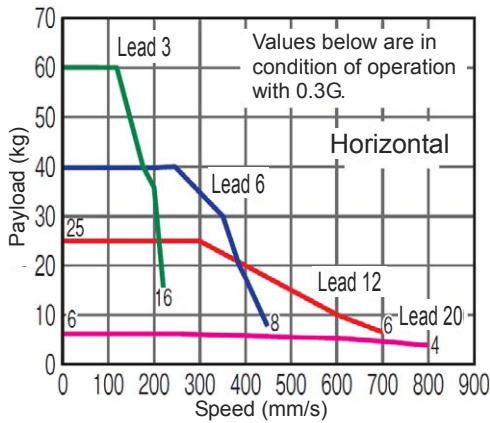

R66R

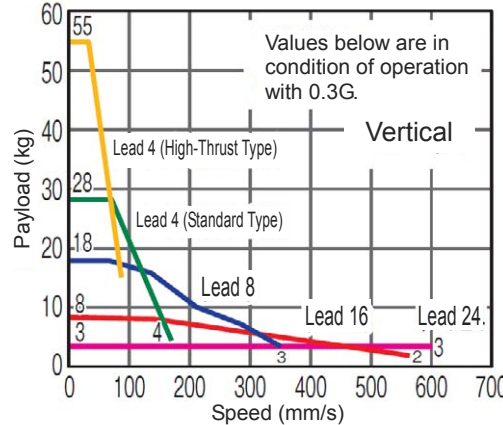
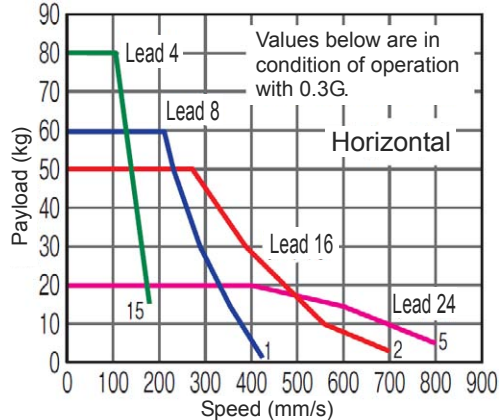

Correlation diagram of speed and payload for the RCP4 rod type (High output effective / Motor-reversing type)

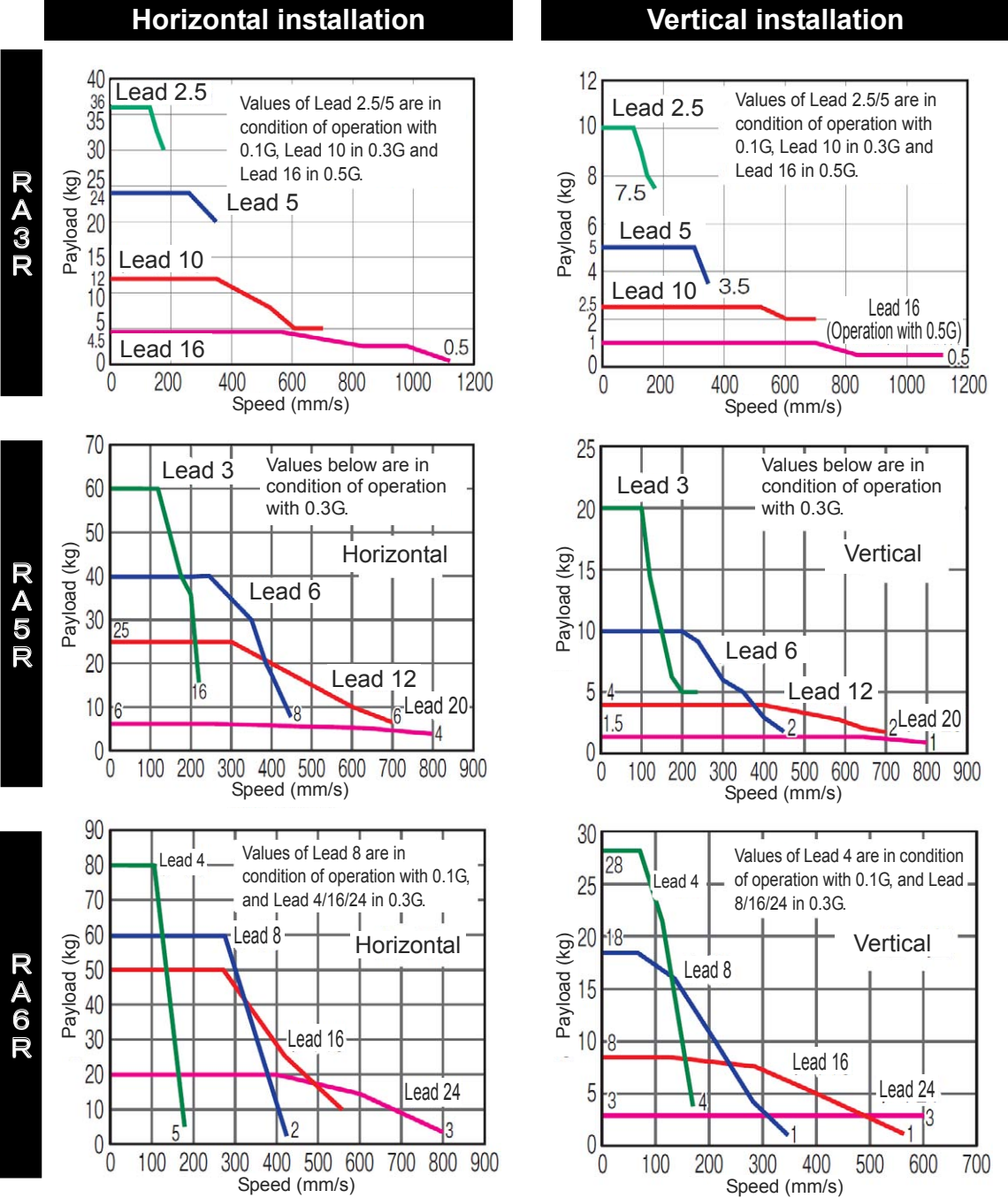

Correlation diagram of speed and payload for the RCP4W dust and drip proof rod type (High output effective)

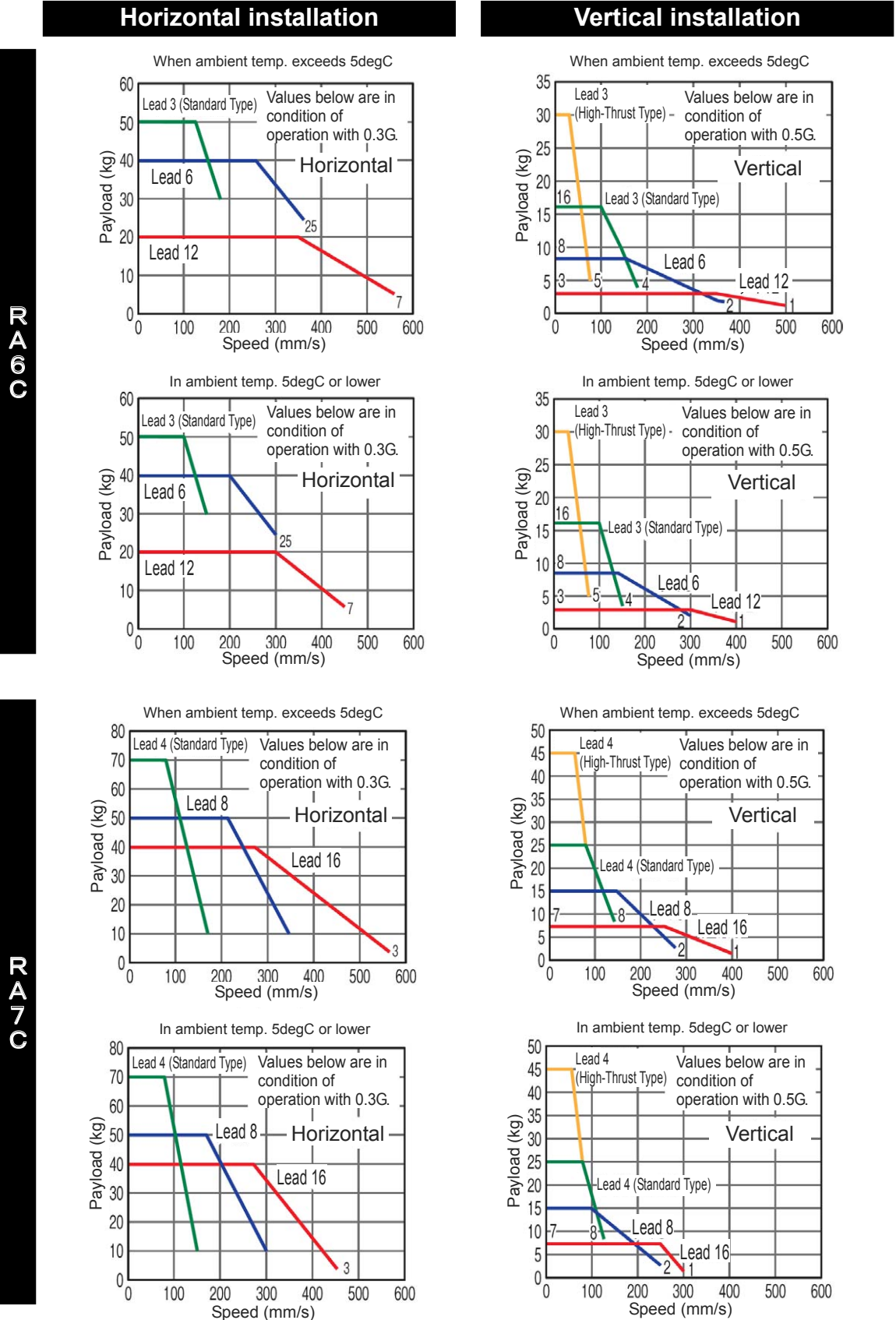

Correlation diagram of speed and payload for the RCP3 slider type

* Characteristics should be the same for reversed type (SA2AR/SA2BR).

Horizontal installation (* Not Available for Vertical Installation)

Vertical installation

**S
A
2
A
C**

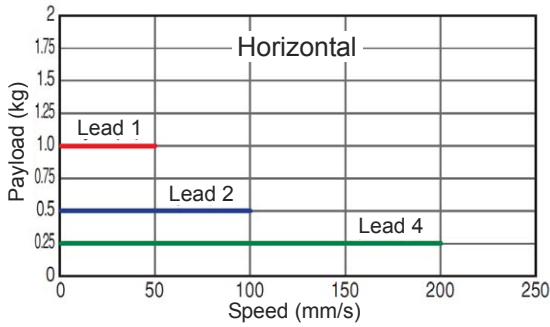

**Vertical Installation
Unavailable**

**S
A
2
B
C**

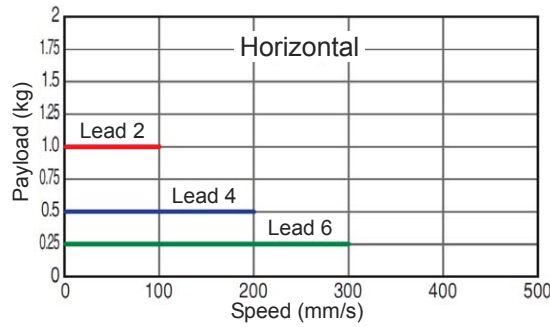

**Vertical Installation
Unavailable**

Correlation diagram of speed and payload for the RCP3 slider type

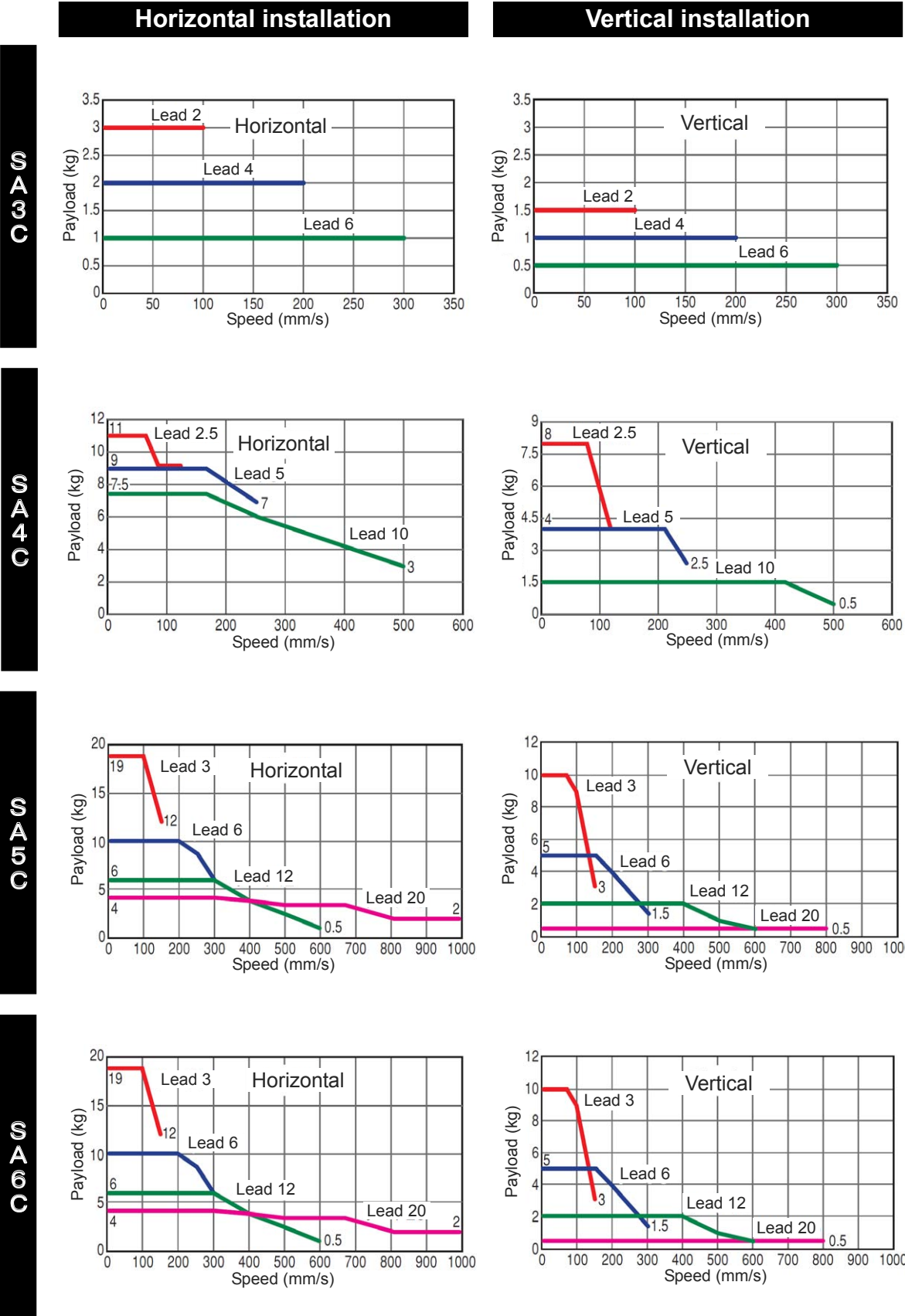

Correlation diagram of speed and payload for the RCP3 slider type (Motor-reversing type)

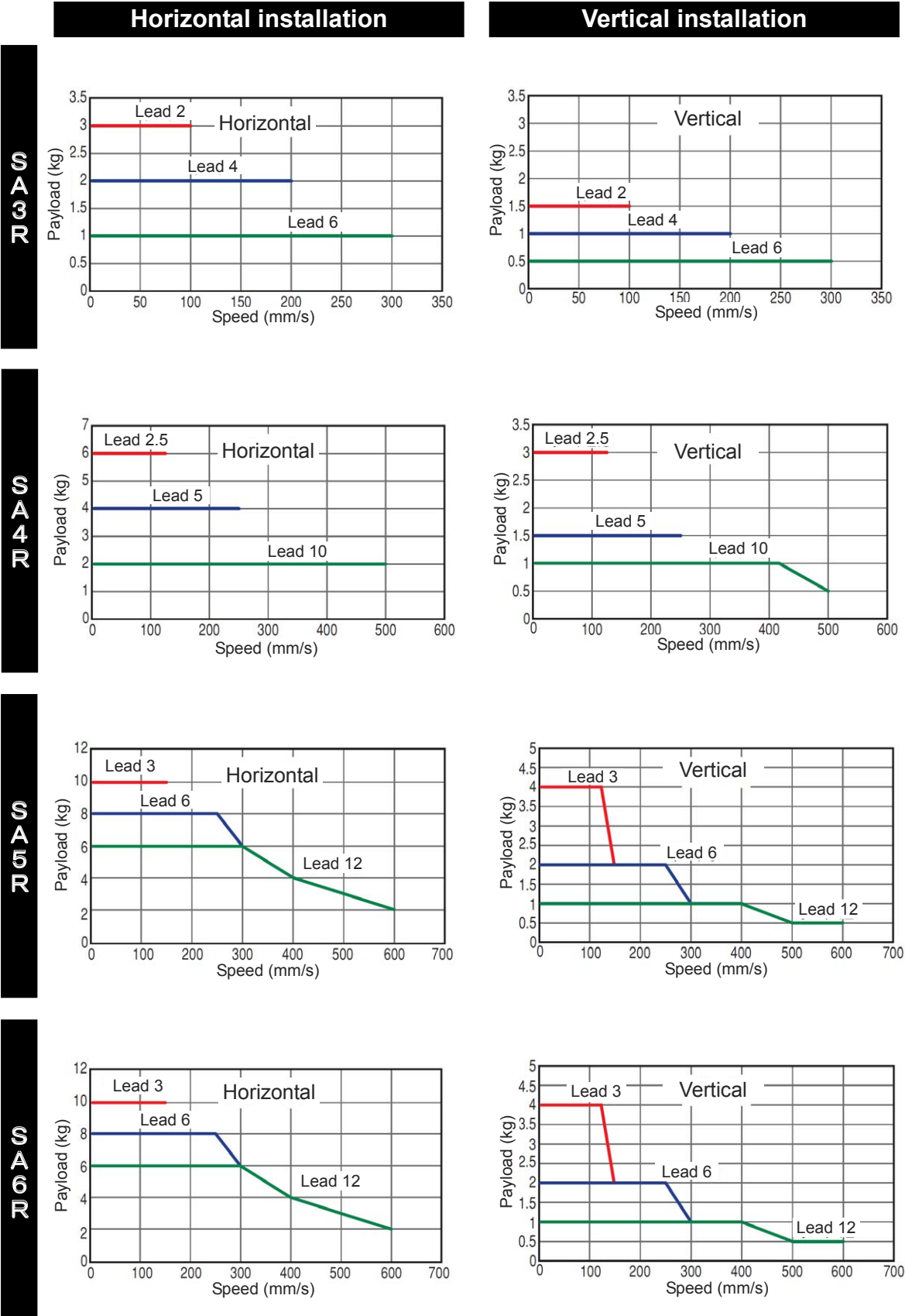

Correlation diagram of speed and payload for the RCP3 rod type

RA2AC/RA2AR

Horizontal installation

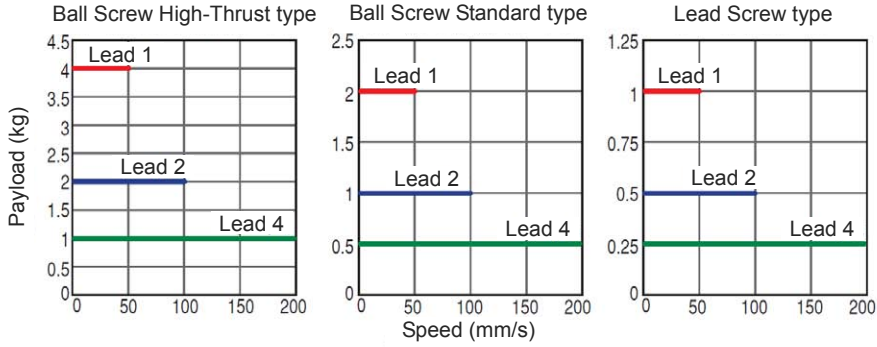

Vertical installation

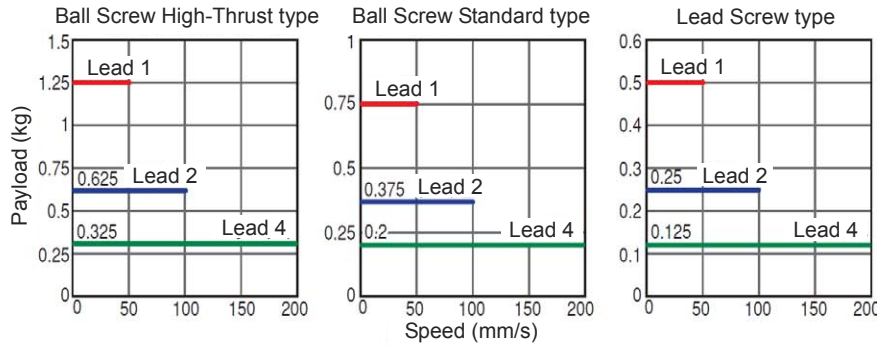

RA2BC/RA2BR

Horizontal installation

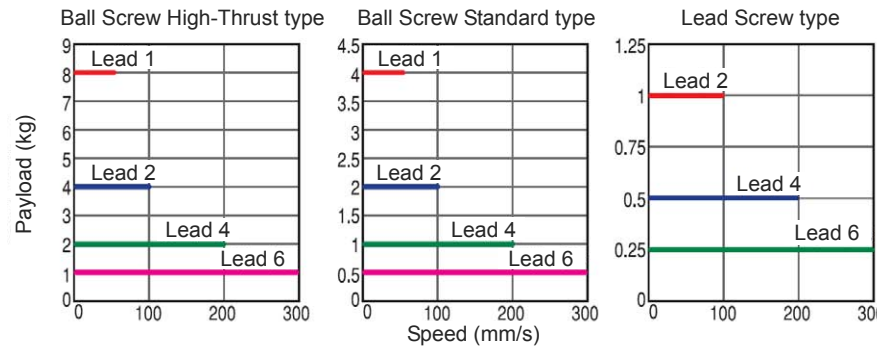

Vertical installation

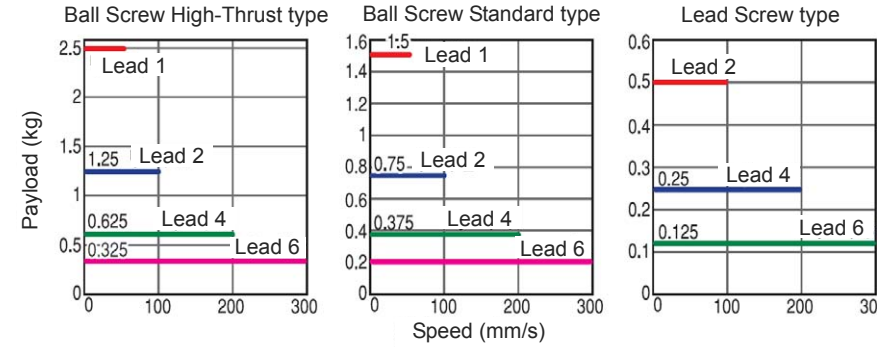

Correlation diagram of speed and payload for the RCP3 table type

* Characteristics should be the same for reversed type.

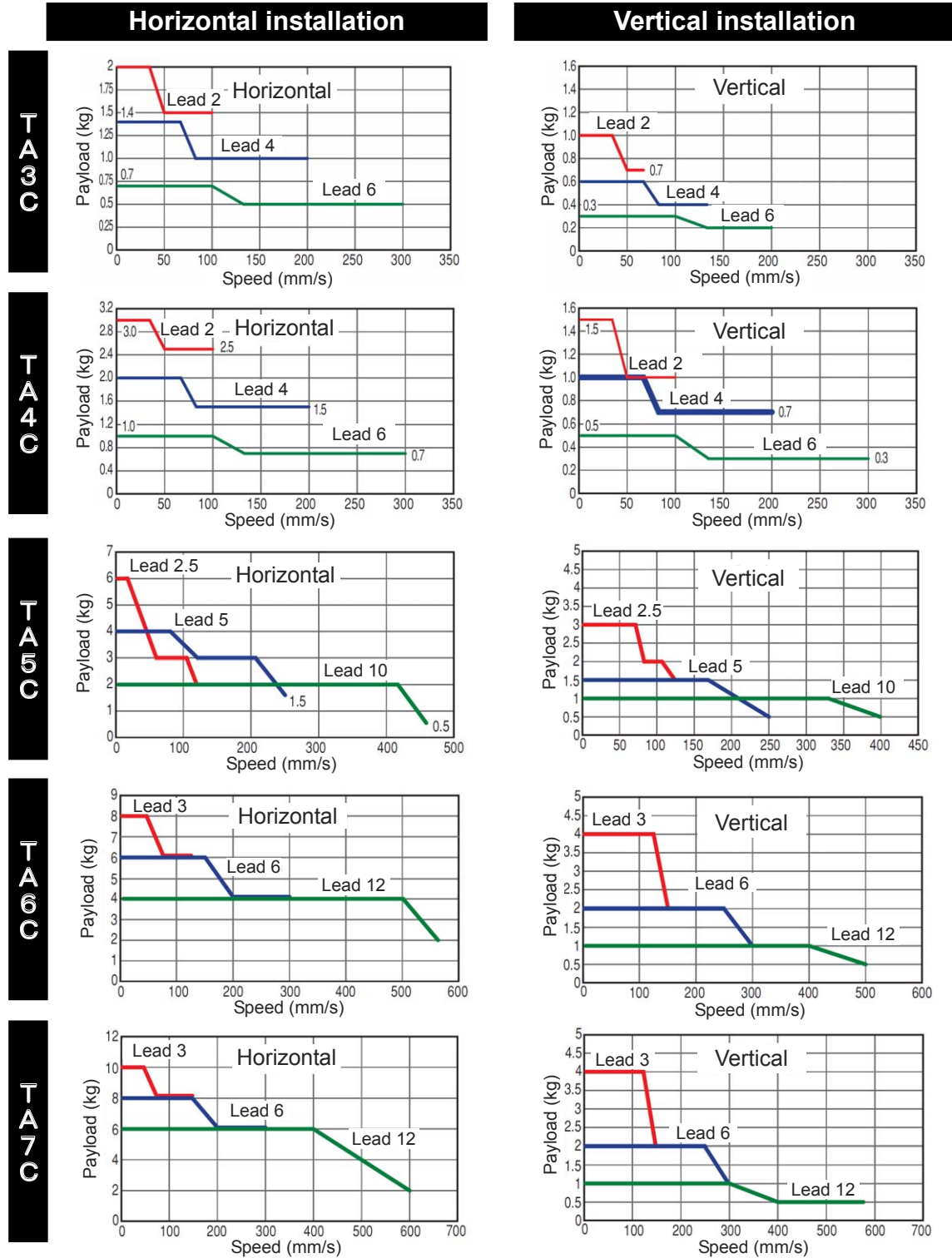

Correlation diagram of speed and payload for the RCP2 slider type

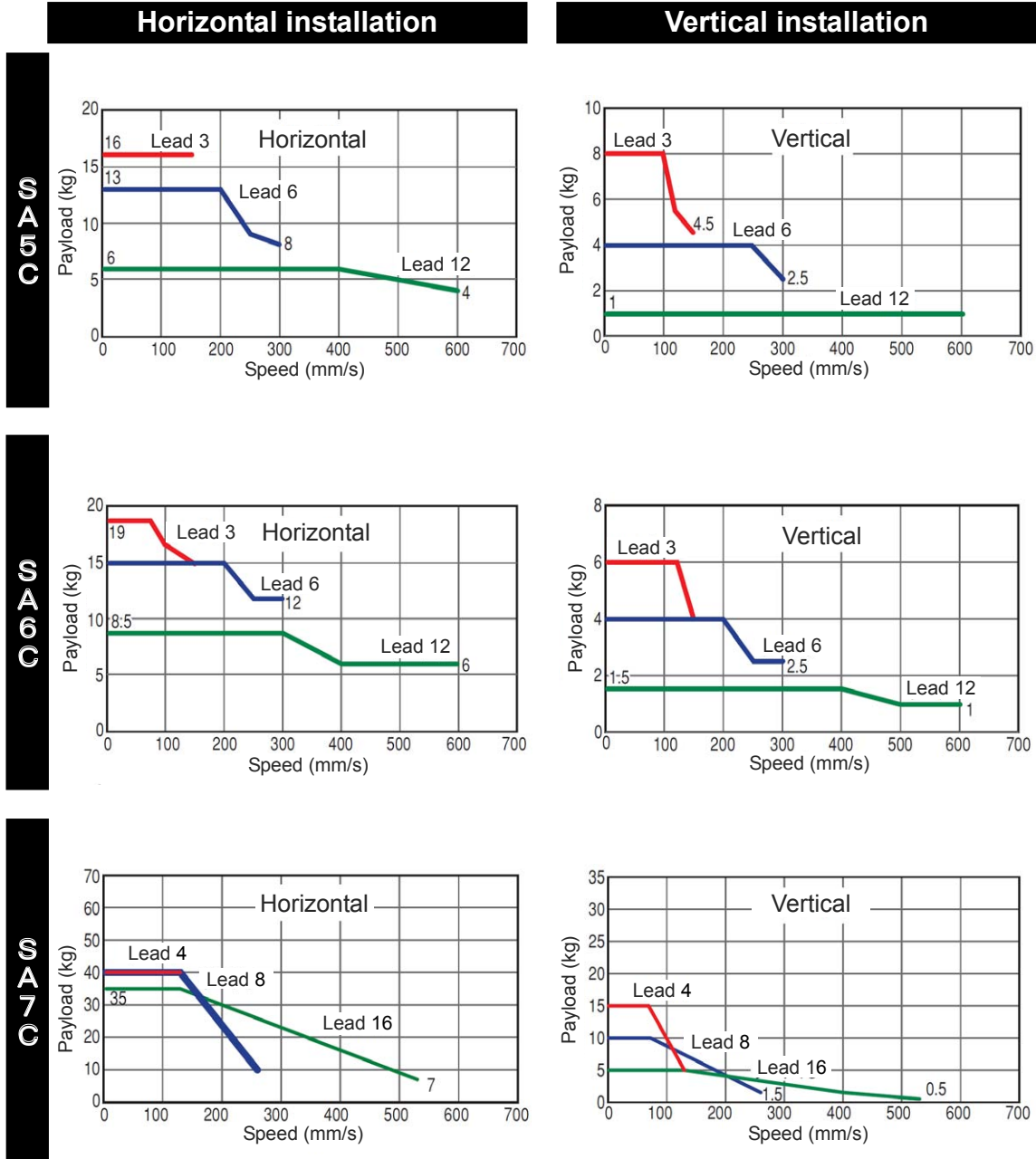

Correlation diagram of speed and payload for the RCP2 slider type

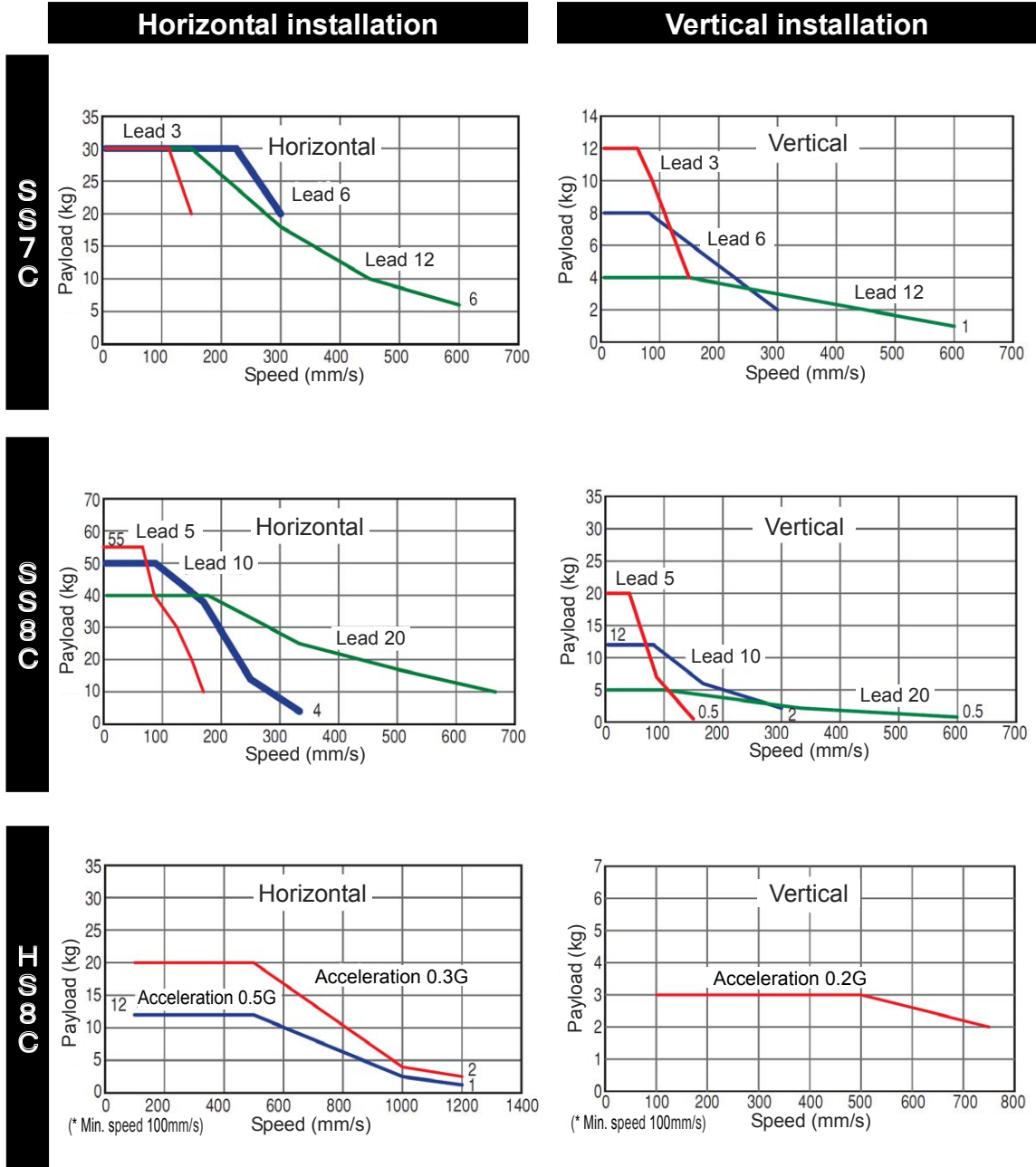

Correlation diagram of speed and payload for the RCP2 slider type (Motor-reversing type)

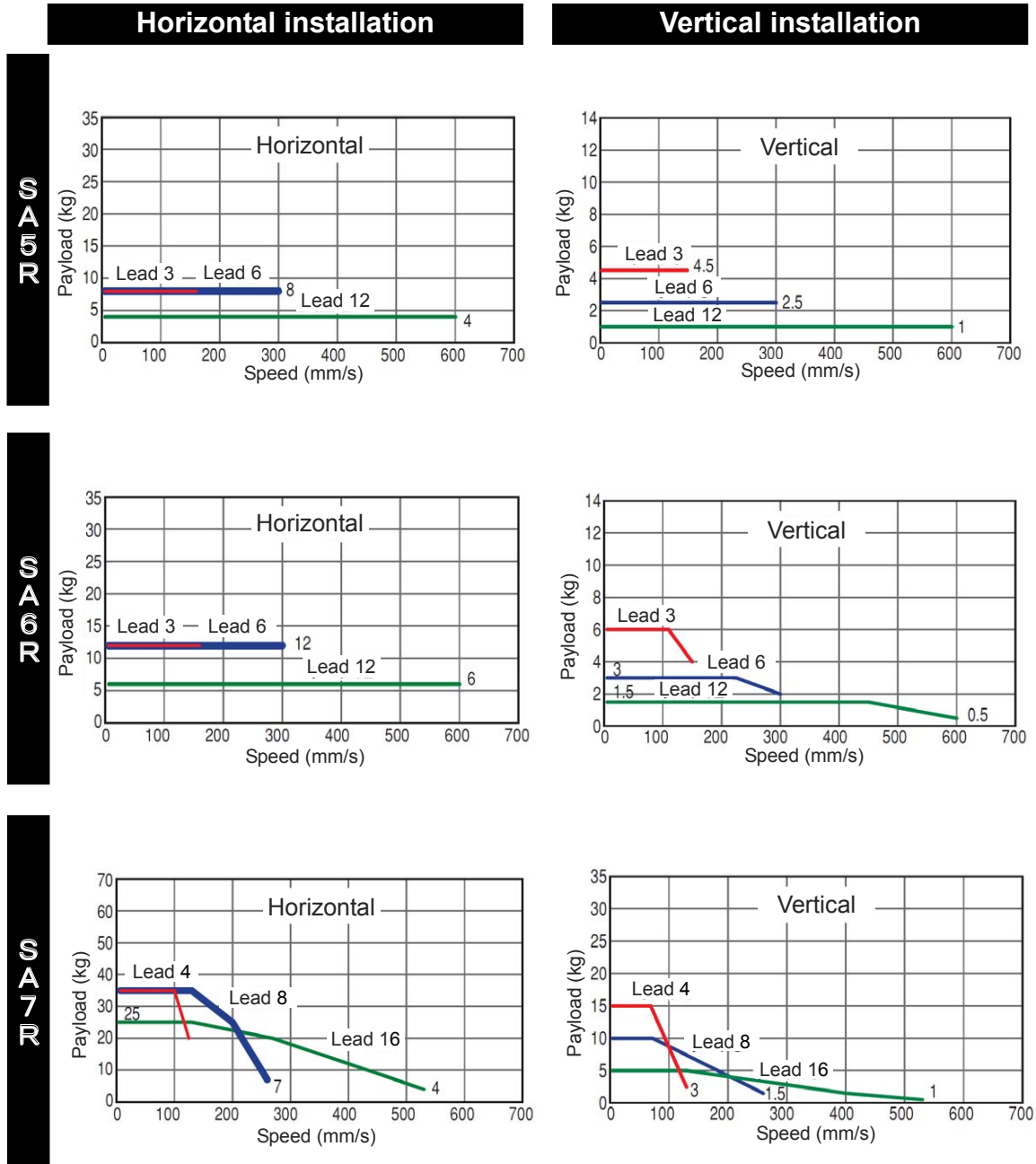

Correlation diagram of speed and payload for the RCP2 slider type (Motor-reversing type)

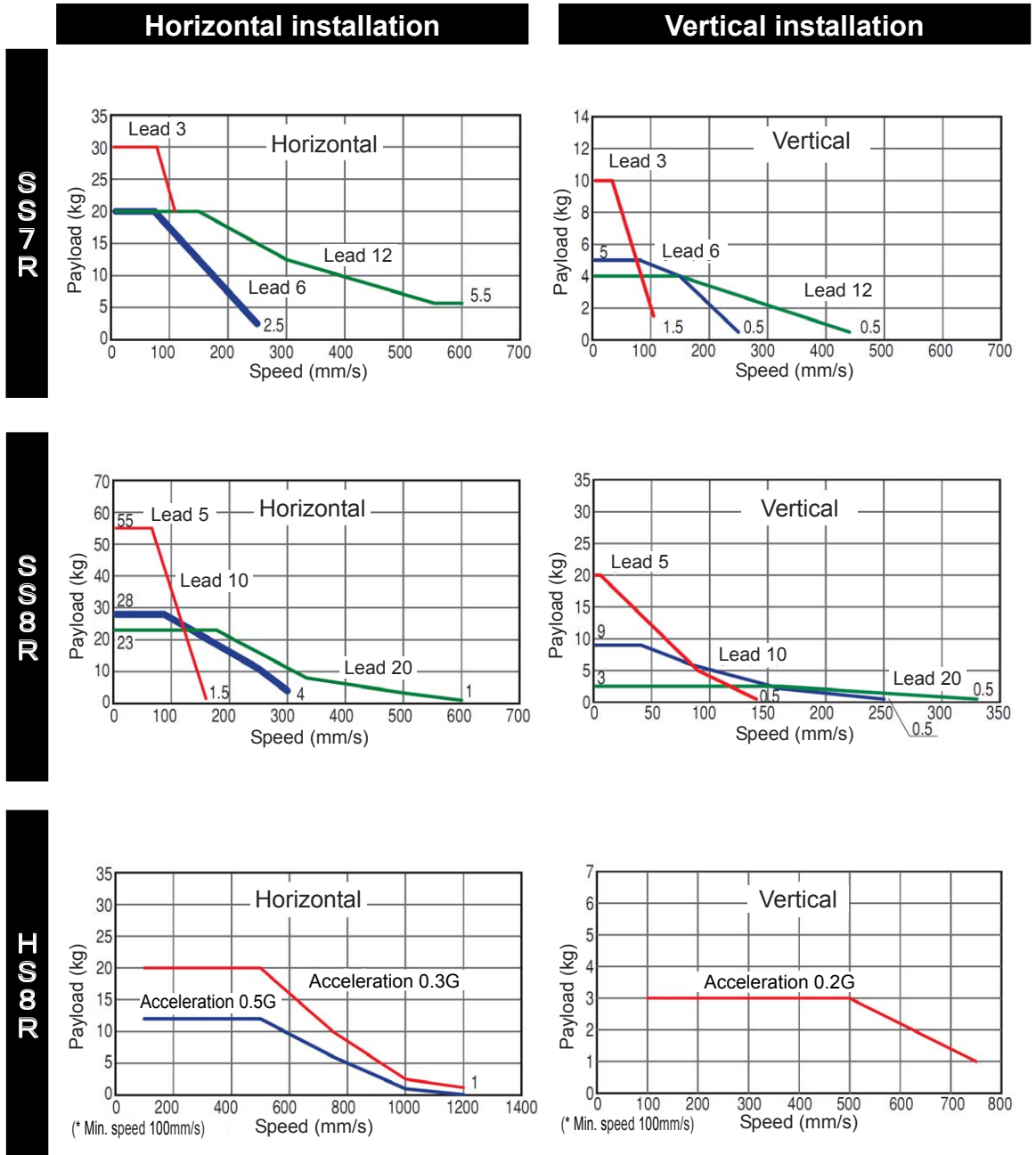

Correlation diagram of speed and payload for the standard RCP2 rod type

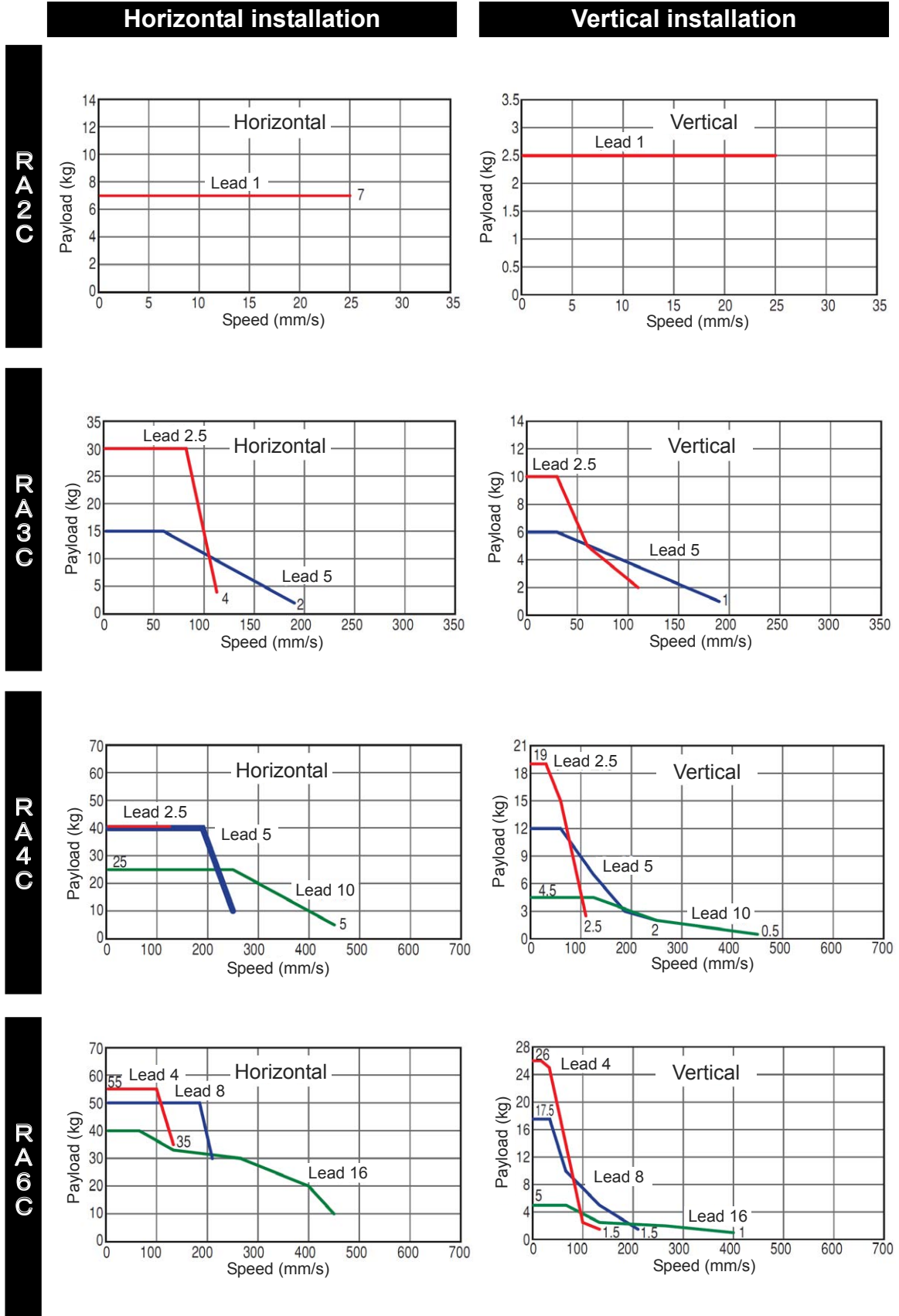

Correlation diagram of speed and payload for the standard RCP2 rod type

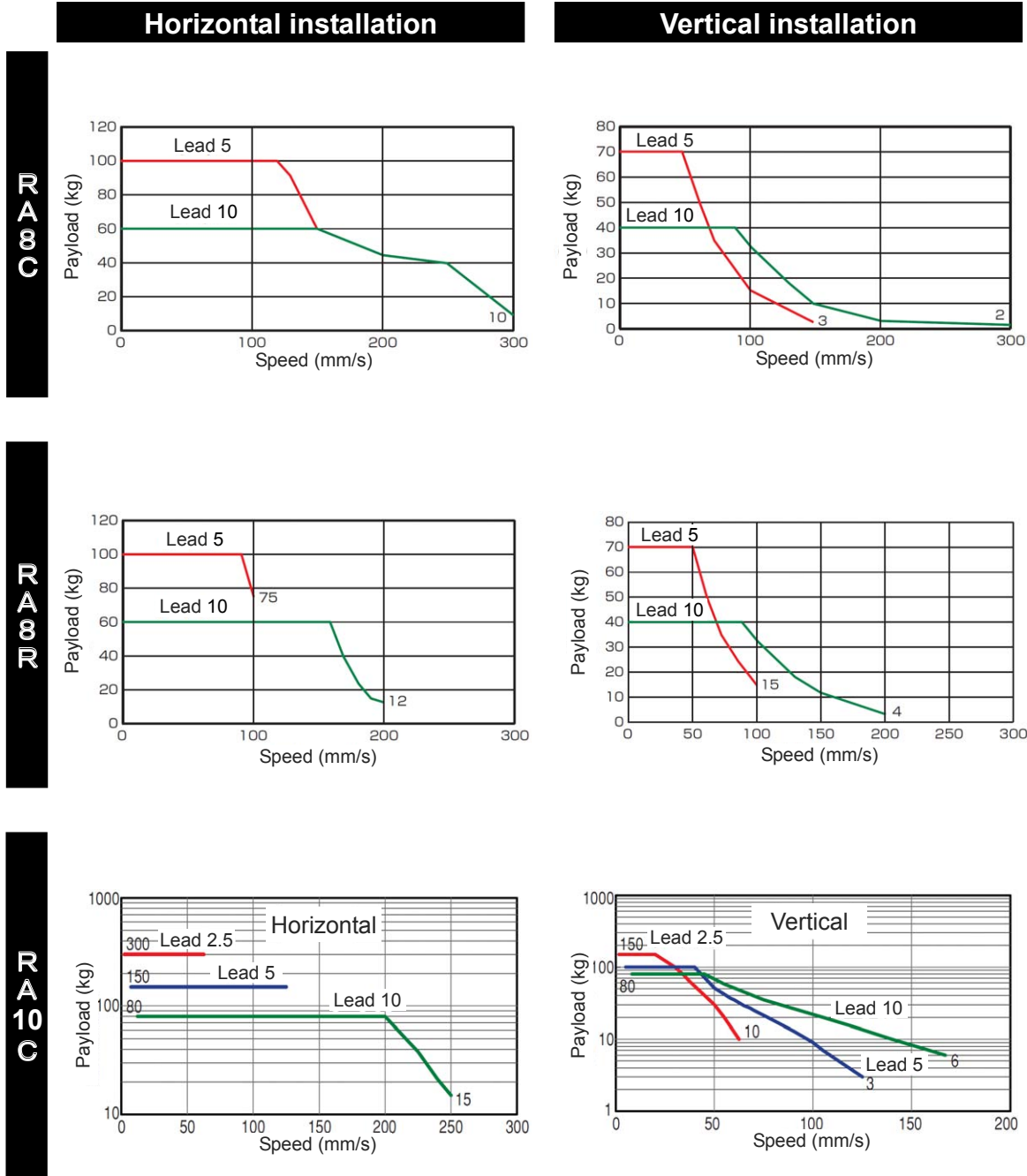

Correlation diagram of speed and payload for the RCP2 rod short type (Standard / Equipped with Guide)

Horizontal installation

Vertical installation

C4SQR

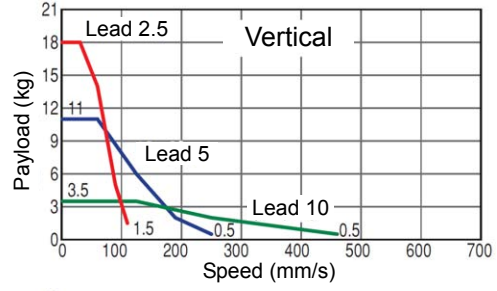
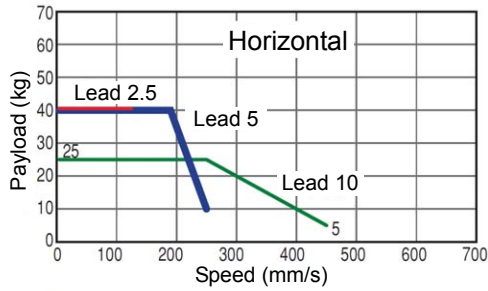

C6SQR

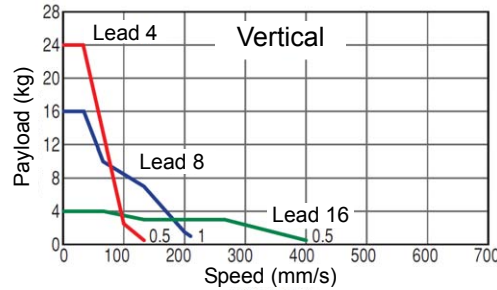
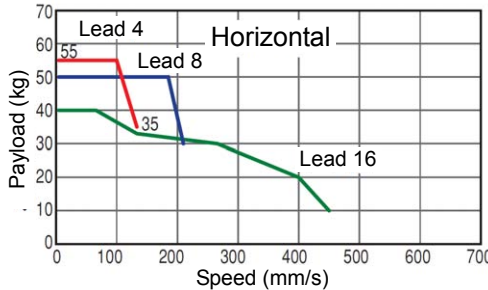

C3DGR

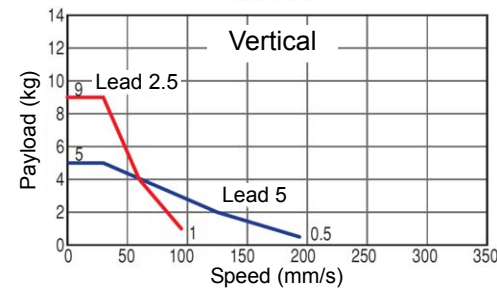
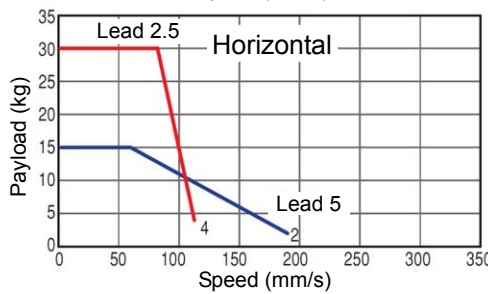

C4DGR

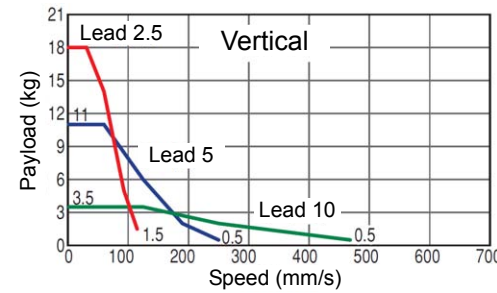
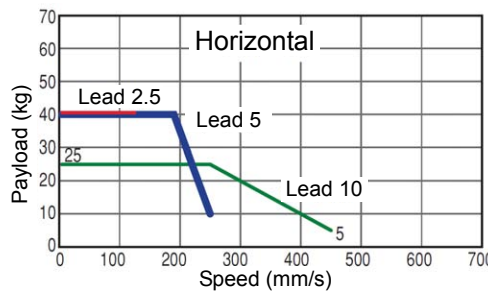

C6DGR

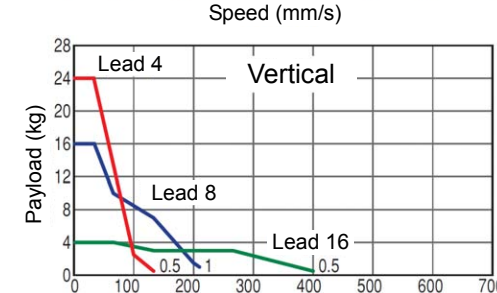
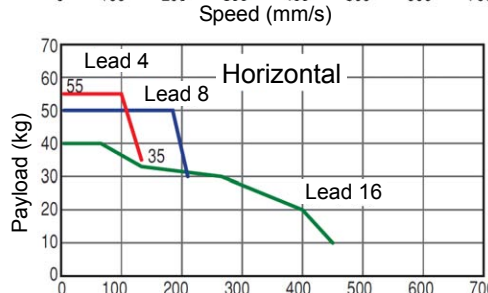

Correlation diagram of speed and payload for the RCP2 rod short type (Standard / Equipped with Guide)

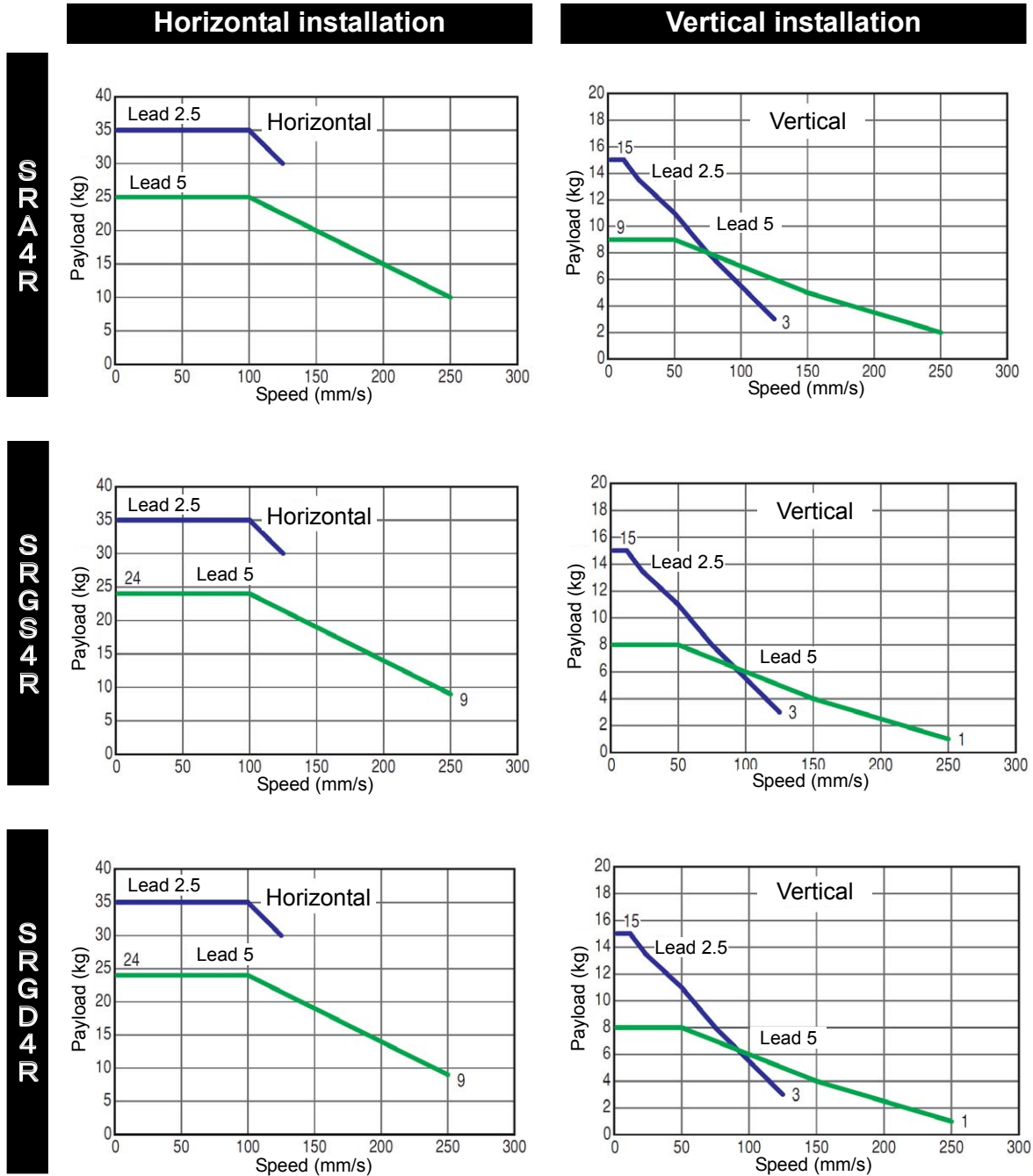

Correlation diagram of speed and payload for the RCP2W dust and drip proof type

* RCP2W-SA16C is dedicated for installation in standard horizontal orientation only.

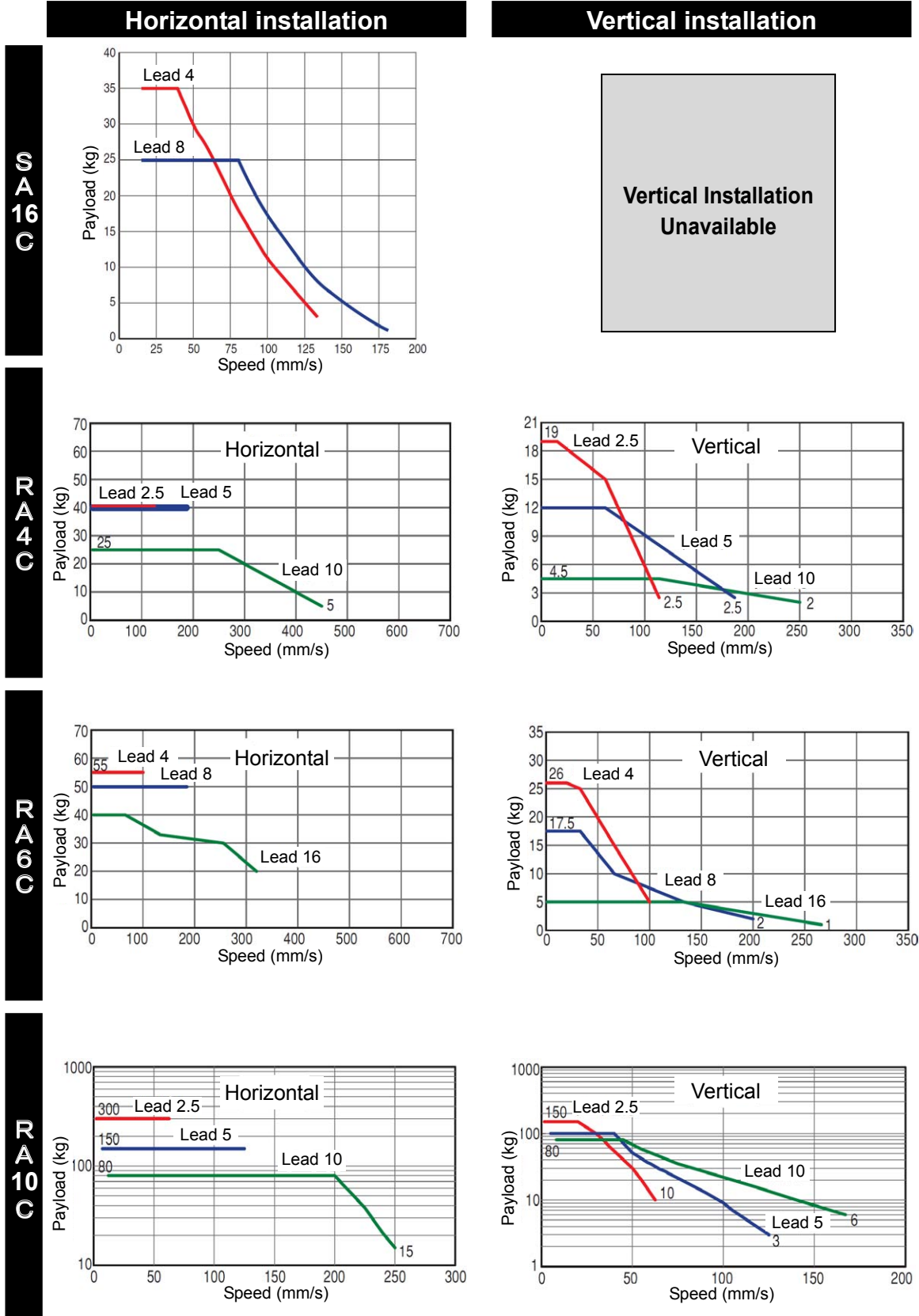

9.6.3 Push Force / Gripping Force and Current Limit Value



Caution

- The correlation of the push force and the current limit value is the rated push speed (in the setting at the delivery) and is a reference value.
- Use the actuator with the setting above the minimum push force value. The push force will be unstable if it is below the minimum push force value.
- If the positioning speed setting in the operation condition is made lower than the push speed, the push speed will follow that speed, thus cannot perform the expected push force.

RCP6 Series (Slider type / Rod type / Table type)

* Characteristics should be the same for Cleanroom/Dust and drip proof type.

SA4/RA4/RRA4/TA4 type

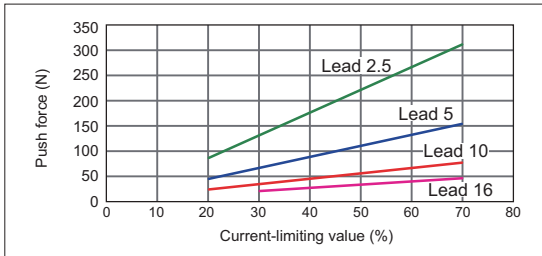

* RCP6W should start pressing at the current limit of 30% or more.

SA6/RA6/RRA6/TA6 type

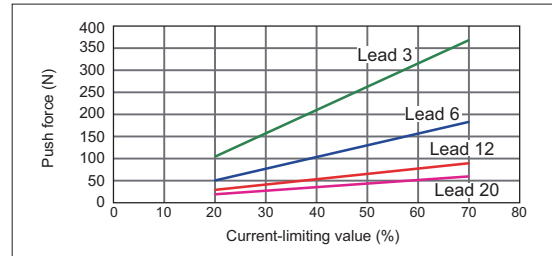

* RCP6W should start pressing at the current limit of 30% or more.

SA7/TA7/WSA14 type

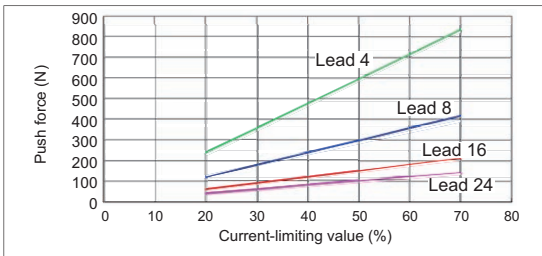

SA8 type

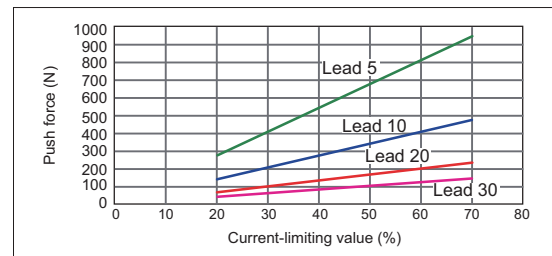

WSA10/WRA10 type

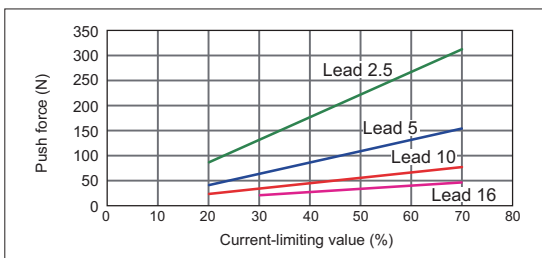

* RCP6W should start pressing at the current limit of 30% or more.

WSA12/WRA12 type

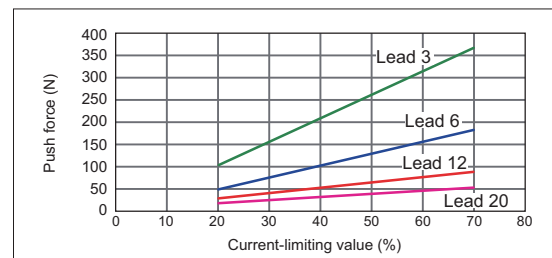

* RCP6W should start pressing at the current limit of 30% or more.

RCP6 Series (Slider type / Rod type / Table type)

* Characteristics should be the same for Cleanroom/Dust and drip proof type.

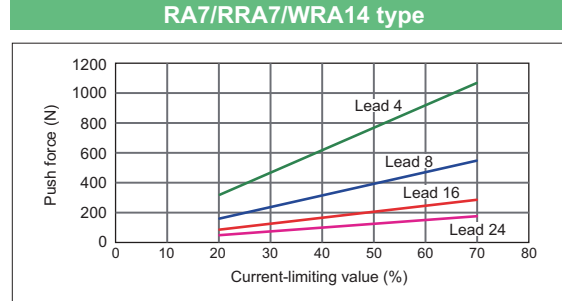
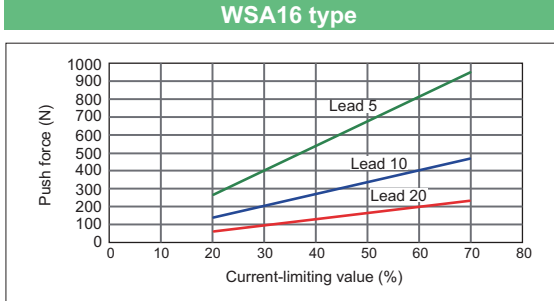

* RCP6W should start pressing at the current limit of 30% or more.

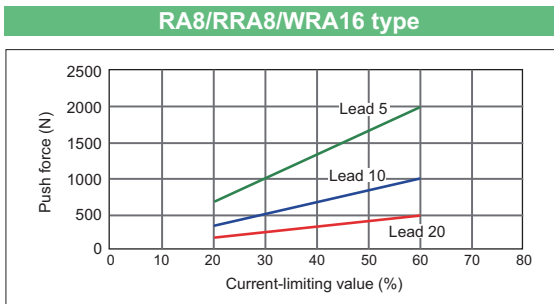

* RCP6W should start pressing at the current limit of 30% or more.

RCP6 Series (Gripper type)

* The grip force shows the total amount of two fingers.

GRT7A

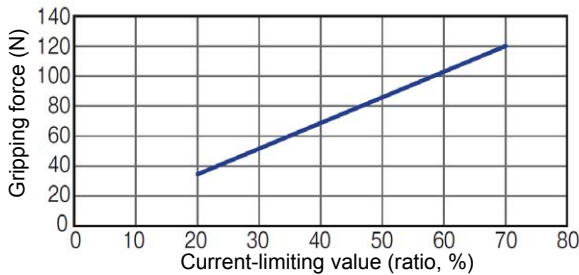

GRT7B

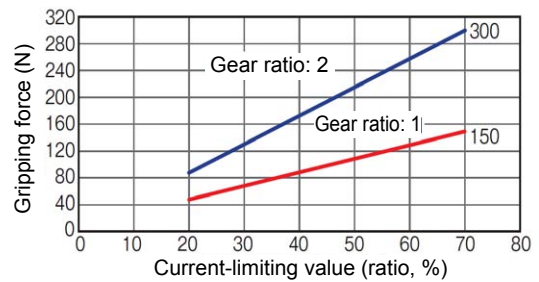

GRST6C/GRST6R

Lead 8

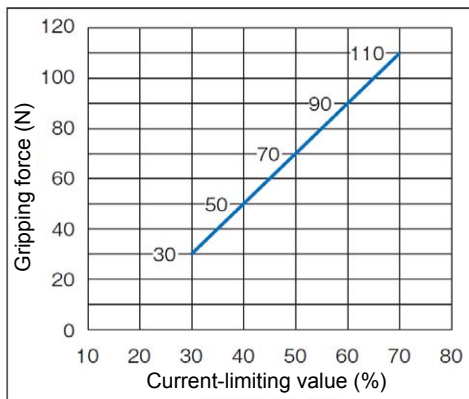

Lead 2

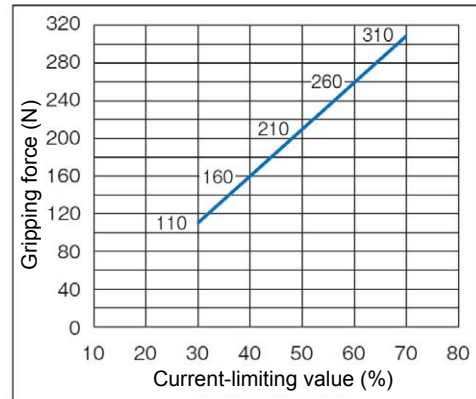

RCP6 Series (Gripper type)

GRST7C/GRST7R

Lead 8

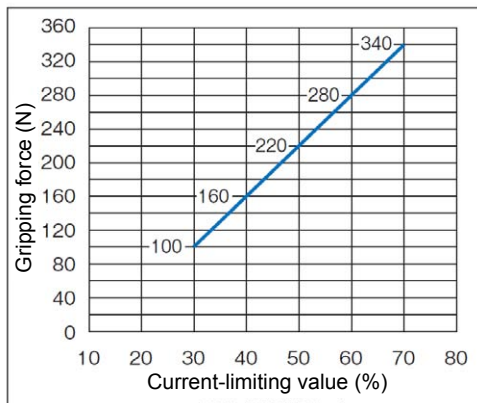

Lead 2

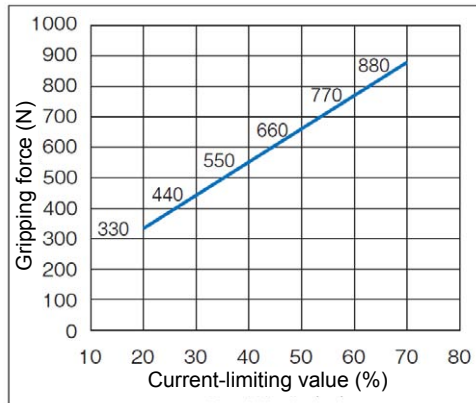

RCP5 Series (Slider type / Rod type)

- RCP5 * Characteristics should be the same for Cleanroom type.

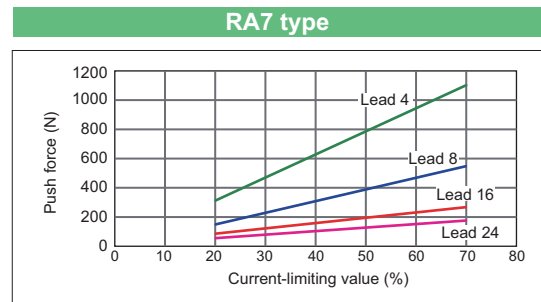
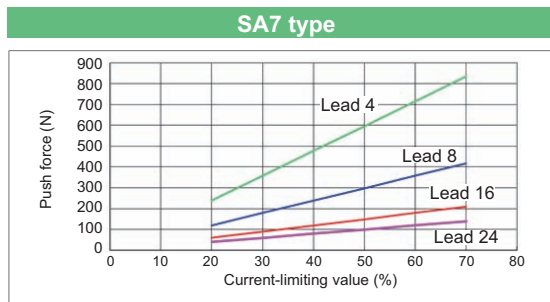
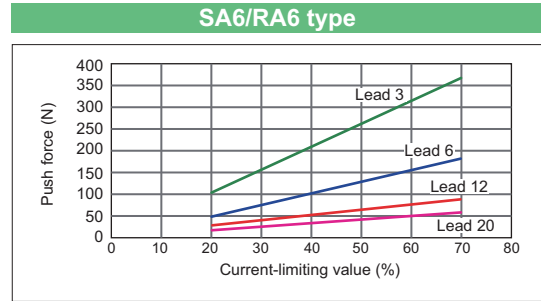
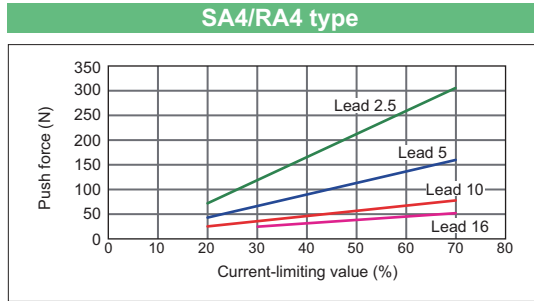

RCP5W

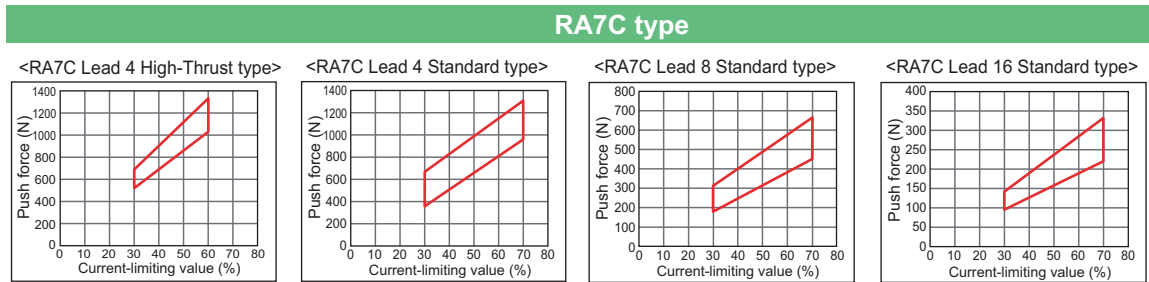
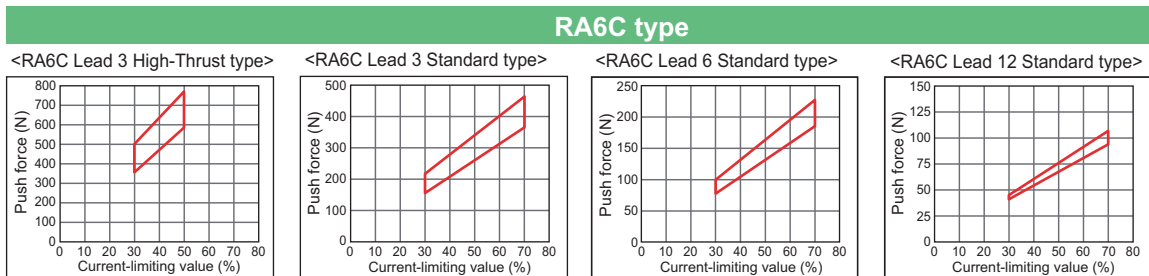

RCP5/RCP5W

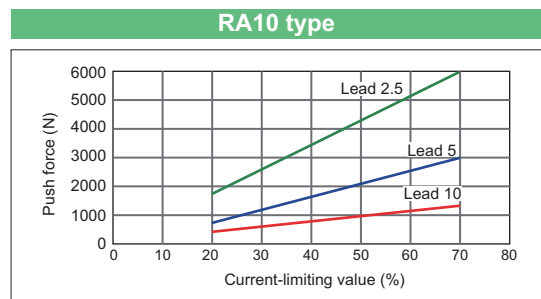
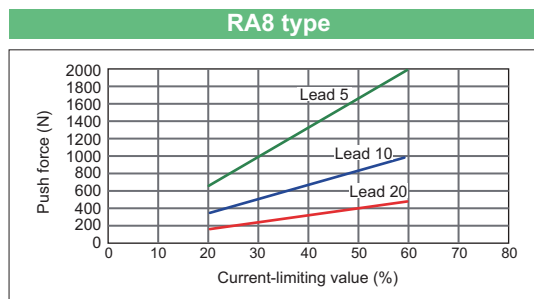

RCP4 Series (Slider type / Rod type)

* Characteristics should be the same for Cleanroom type.

SA3 type

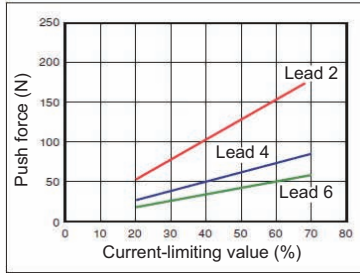

SA3 type

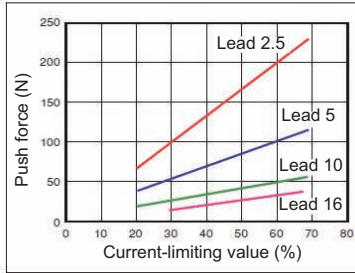

SA5/SA6/RA5 type

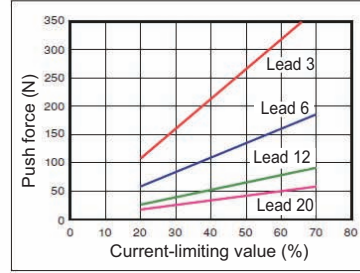

RA6 type

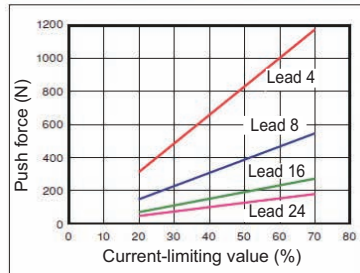

SA7 type

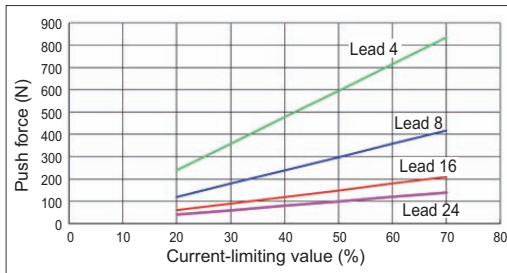

RCP4W-SA5C

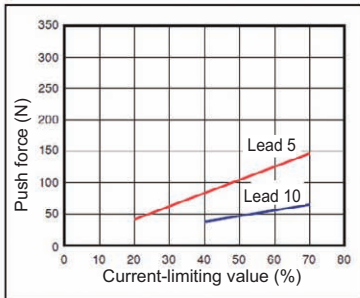

RCP4W-SA6C

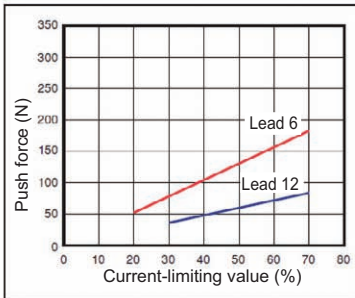

RCP4W-SA7C

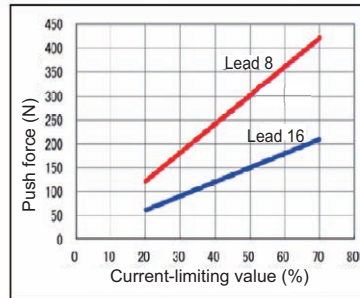

RCP4W-RA6C/RA7C type

<RA6C Lead 3 High-Thrust type>

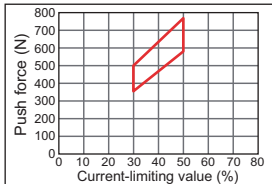

<RA6C Lead 3 Standard type>

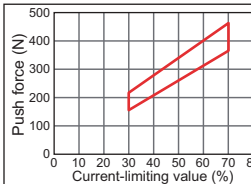

<RA6C Lead 6 Standard type>

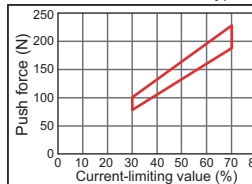

<RA6C Lead 12 Standard type>

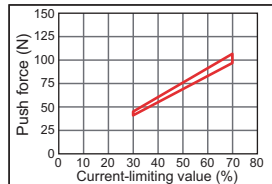

<RA7C Lead 4 High-Thrust type>

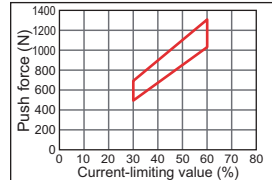

<RA7C Lead 4 Standard type>

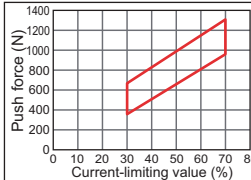

<RA7C Lead 8 Standard type>

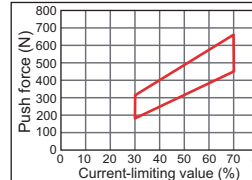

<RA7C Lead 16 Standard type>

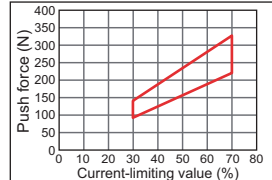

RCP4 Series (Gripper type)

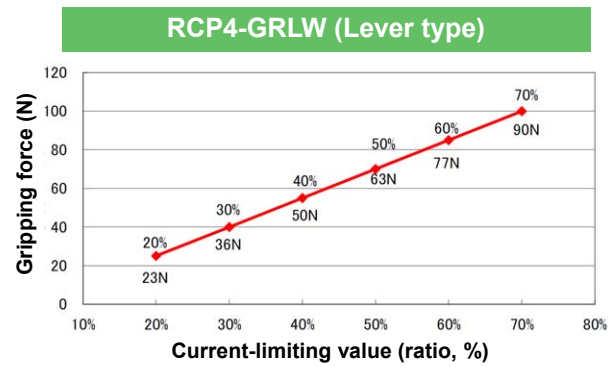
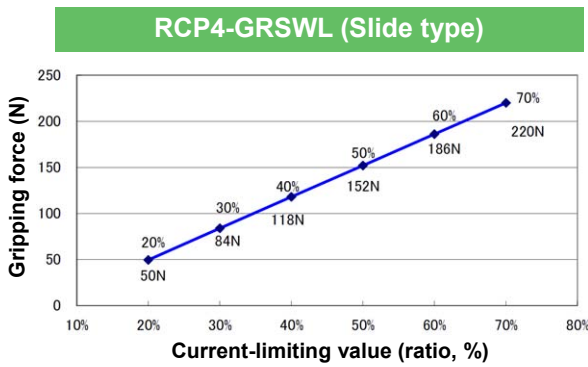
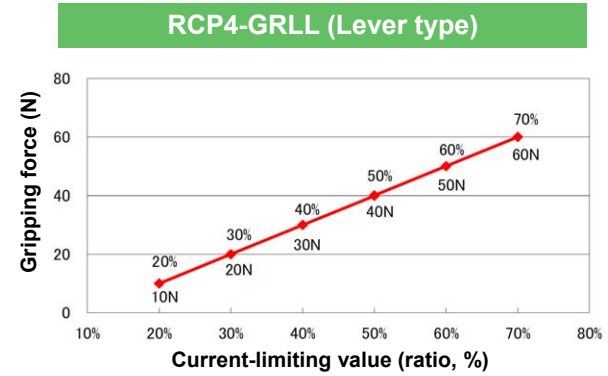
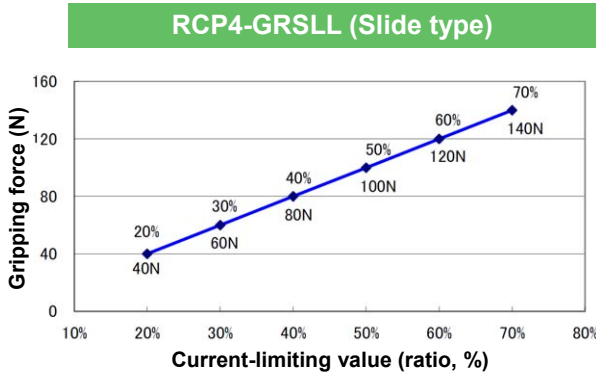
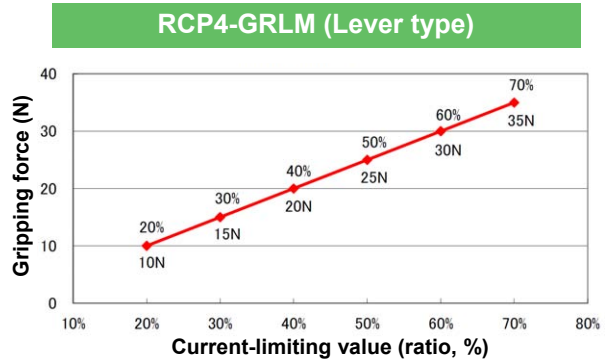
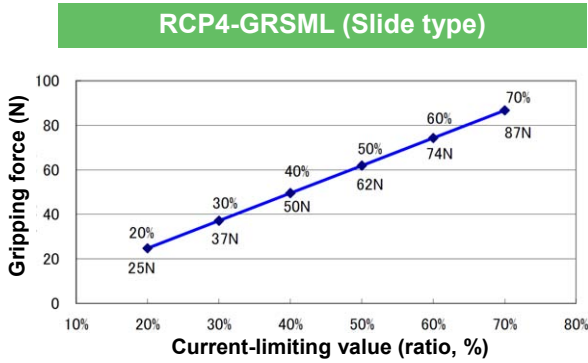

RCP3 Series (Slider type / Table type)

SA3 type

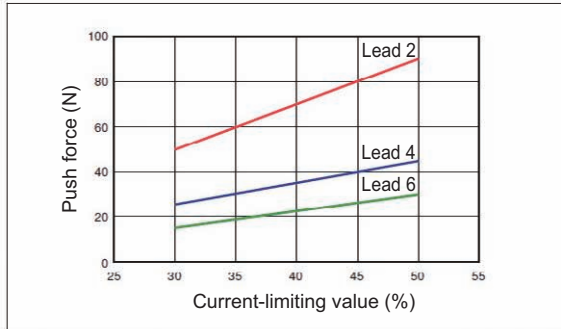

SA4 type

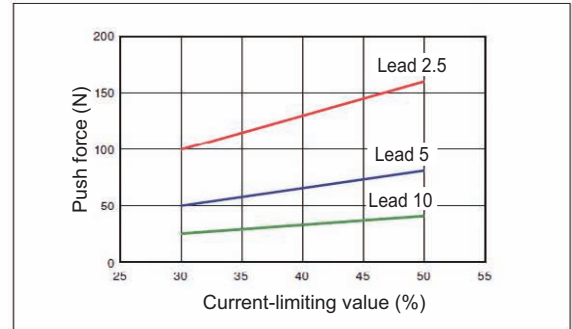

SA5/SA6 type

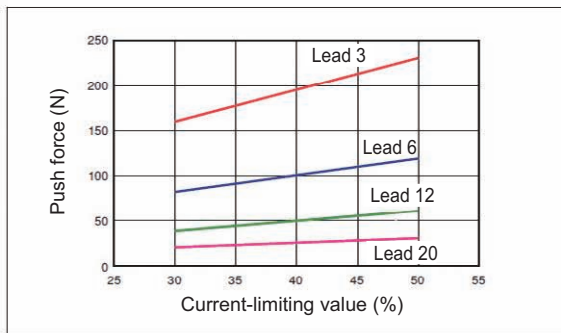

TA3 type

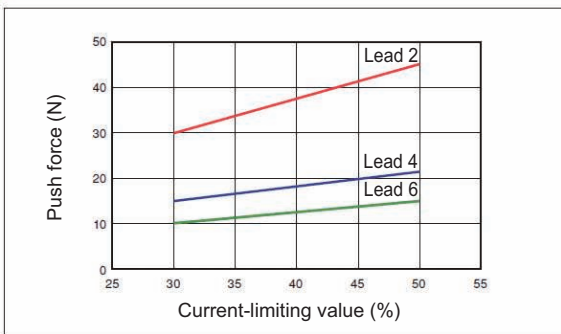

TA4 type

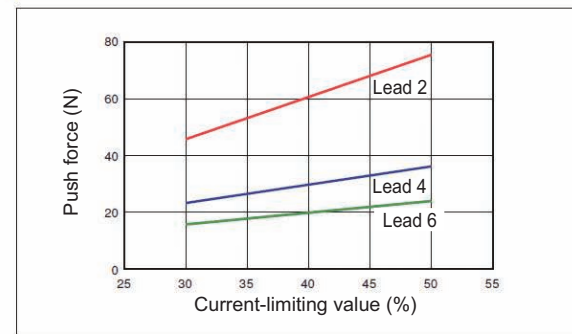

TA5 type

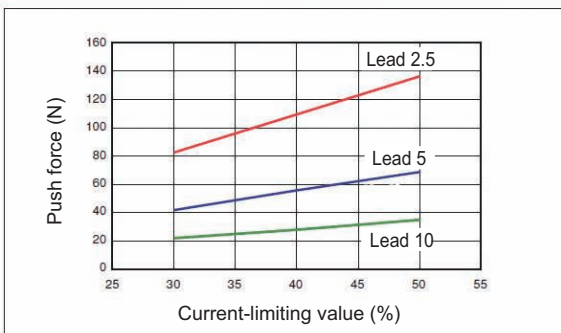

TA6/TA7 type

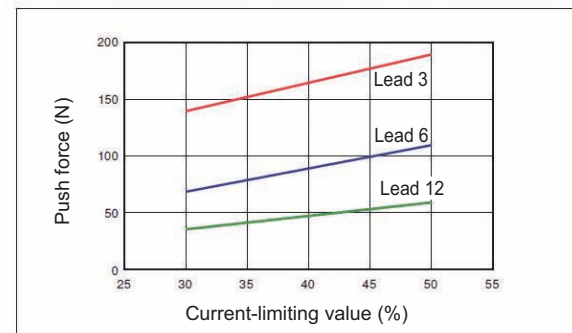

RCP3 Series (Slim, compact rod type) RA2AC/RA2BC/RA2AR/RA2BR

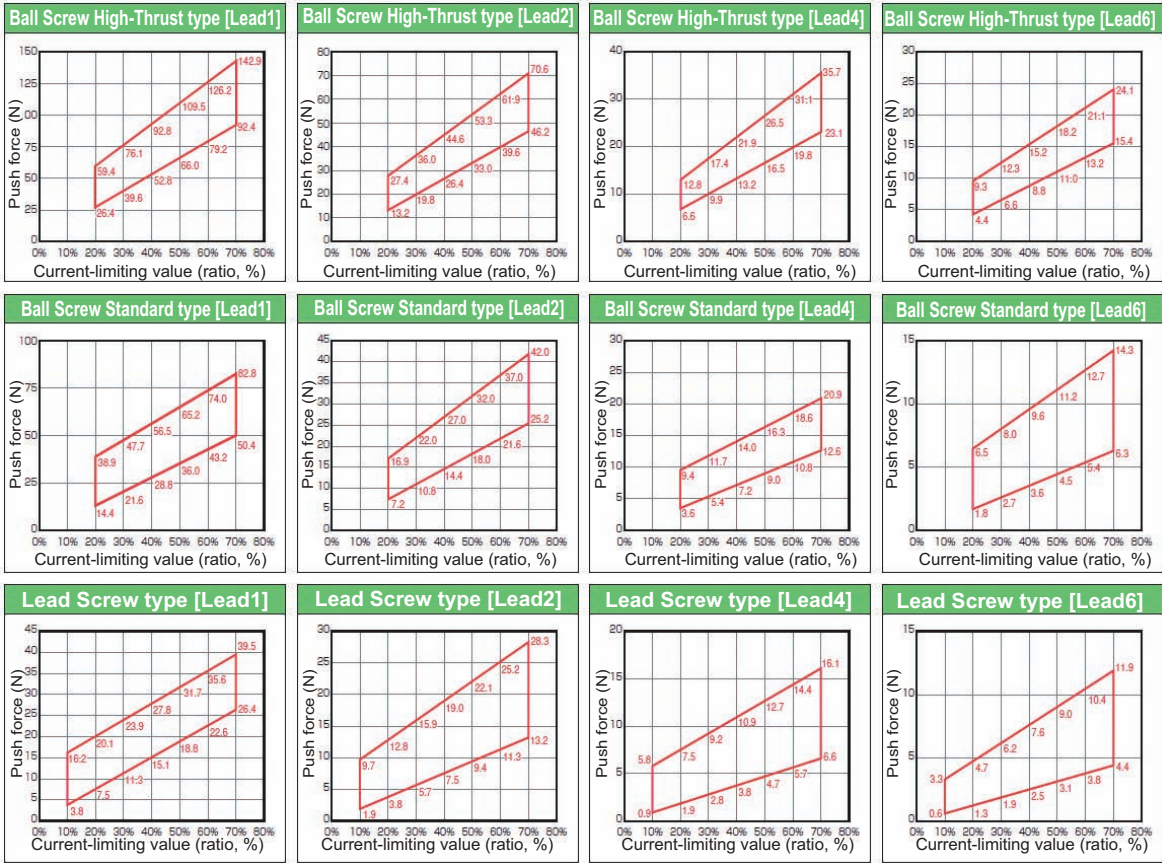

RCP2 Series (Slider type / Rod type)

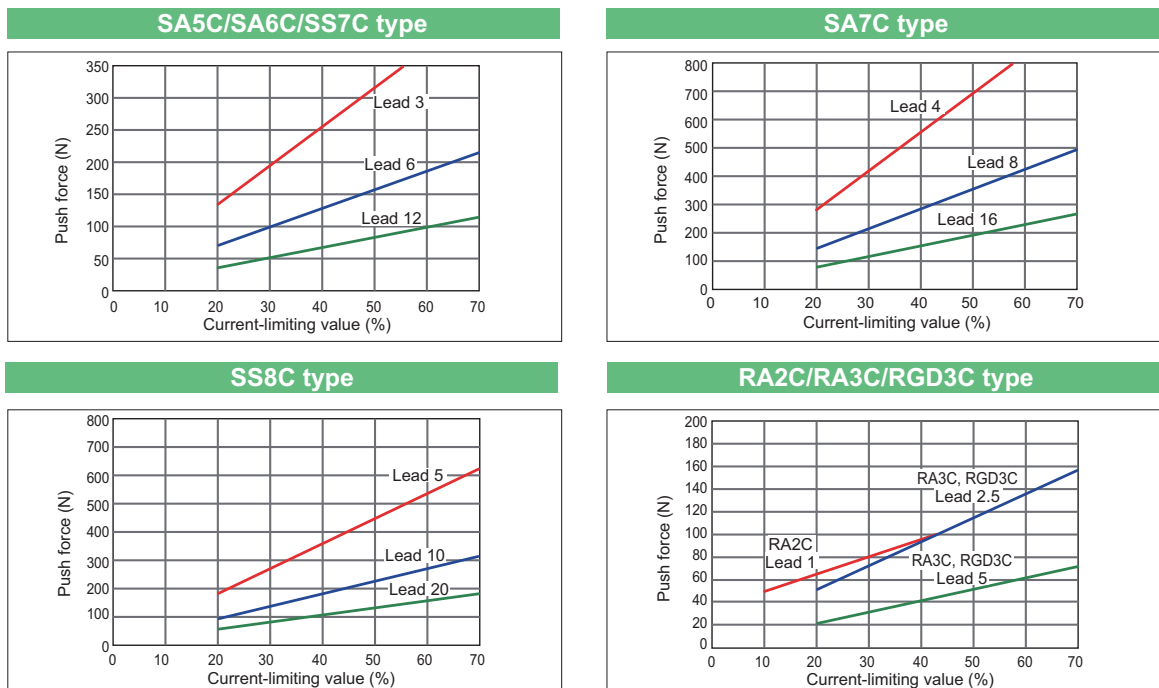

* There is the upper limit for the push force established for each stroke in RA2C. 25•50 Stroke: 100N, 75 Stroke: 70N, 100 Stroke: 55N

RCP2 Series (Slider type / Rod type)

SRA4R/SRGS4R/SRGD4R type

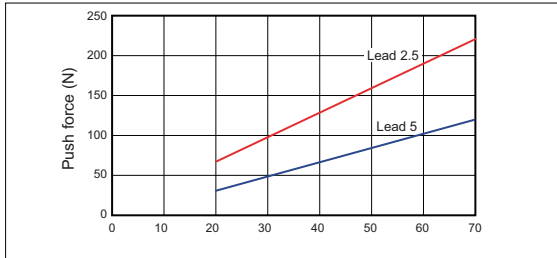

RA4C/RGS4C/RGD4C

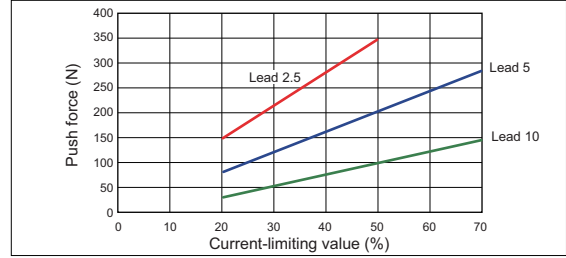

RA6C/RGS6C/RGD6C

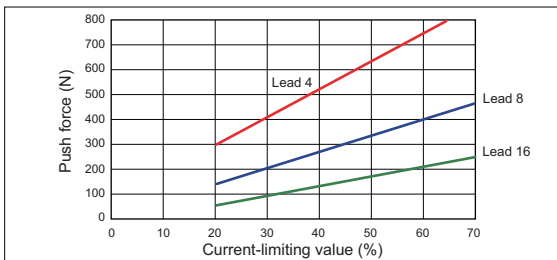

RCP2W-RA4C type

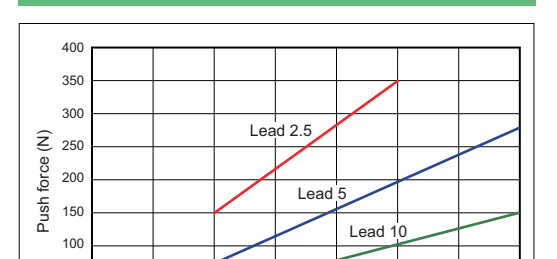

RCP2W-RA6C type

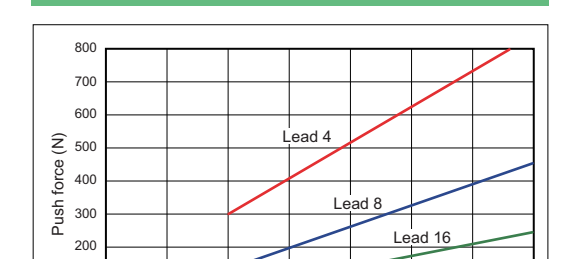

RA8 type

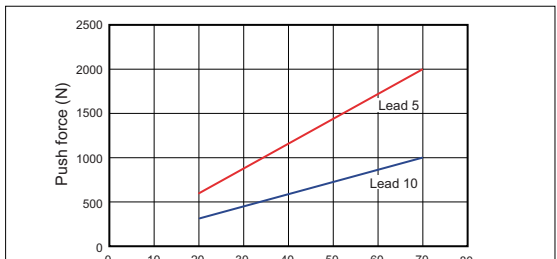

RA10 type

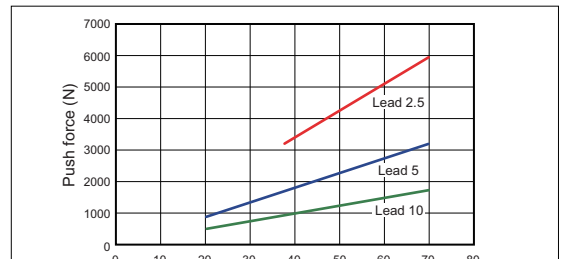

RCP2 Series (2-finger gripper type)

- * Characteristics should be the same for Cleanroom type / Dust and drip proof type.
- * The grip force shows the total amount of two fingers.

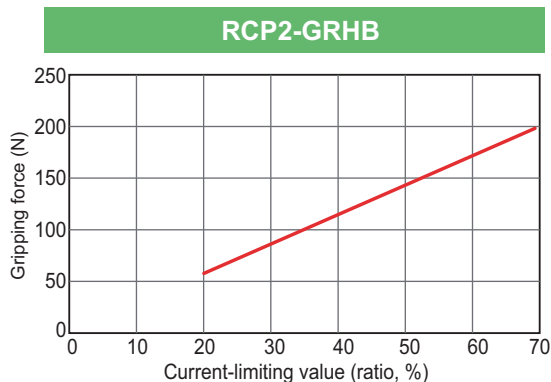
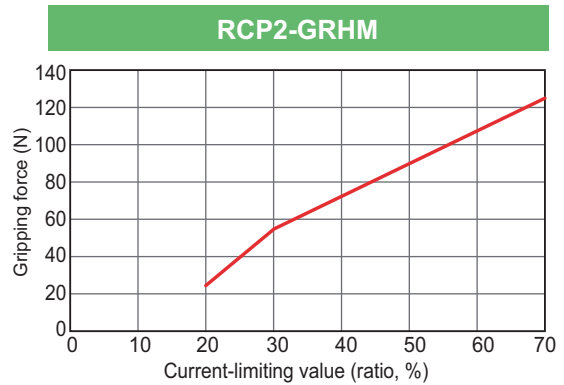
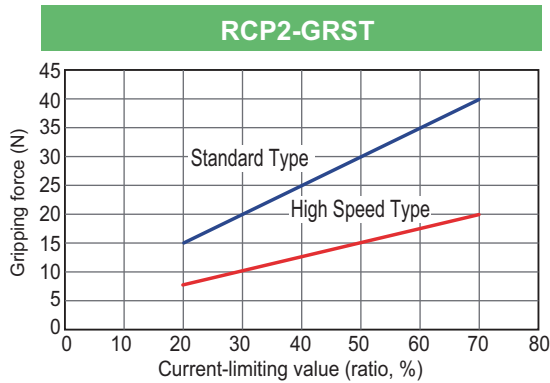
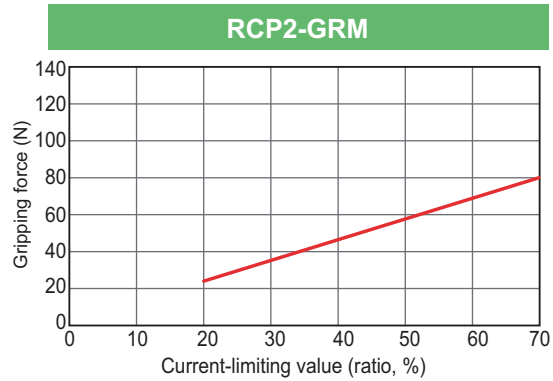
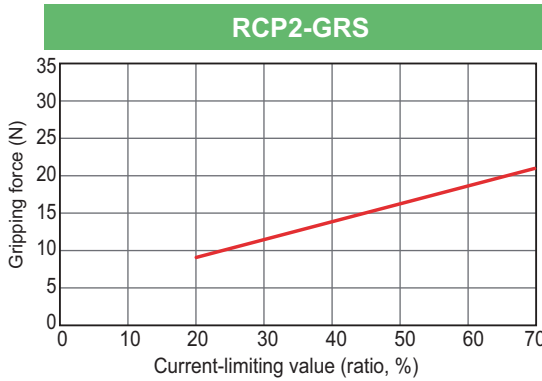
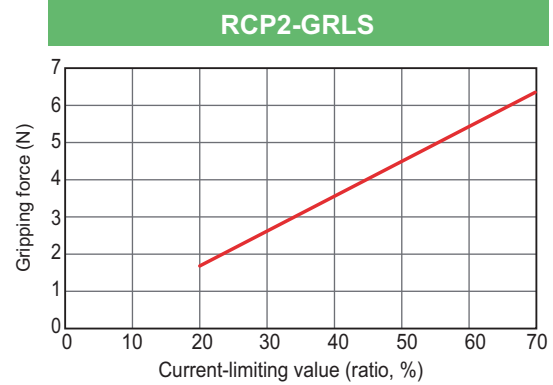
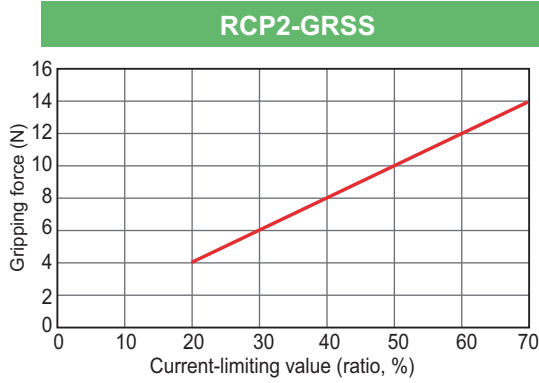

RCP2 Series (3-finger gripper type)

* Characteristics should be the same for Cleanroom type / Dust and drip proof type.

* The grip force may differ depending on the distance to the gripping point.

Refer to the instruction manual of each actuator for detail.

RCP2-GR3LS

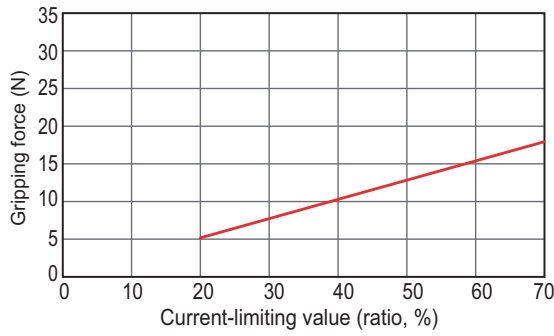

RCP2-GR3LM

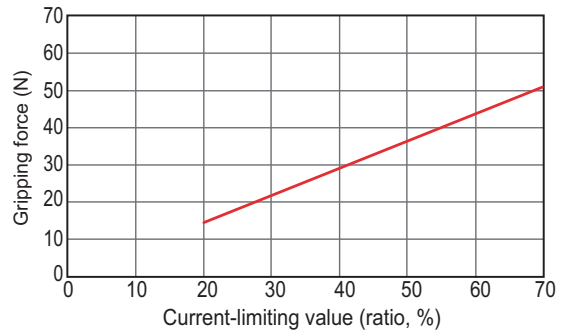

RCP2-GR3SS

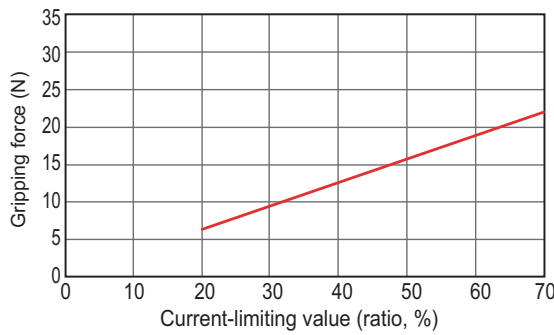

RCP2-GR3SM

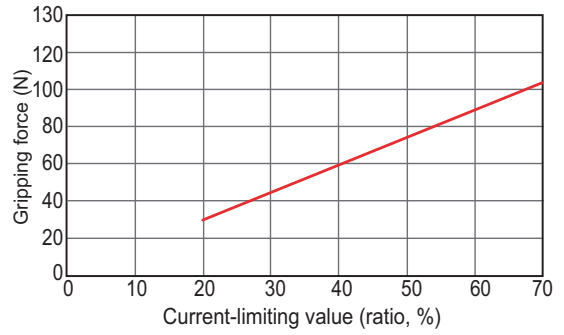

9.6.4 Rotational speed and Output torque / Allowable inertial moment

RCP2 Series (Rotary type)

* Characteristics should be the same for Cleanroom type.

RCP2-RTBS/RTBSL

■ Correlation diagram of rotational speed and output torque

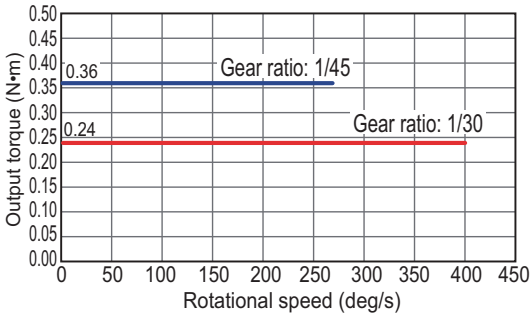

■ Correlation diagram of rotational speed and allowable inertial moment

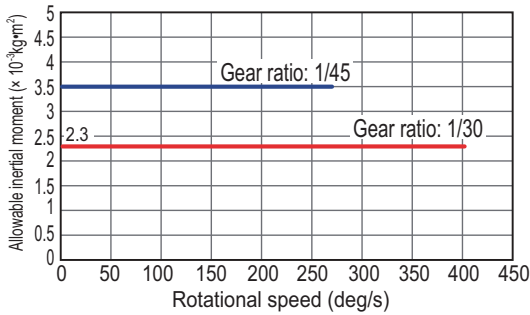

RCP2-RTCS/RTCSL

■ Correlation diagram of rotational speed and output torque

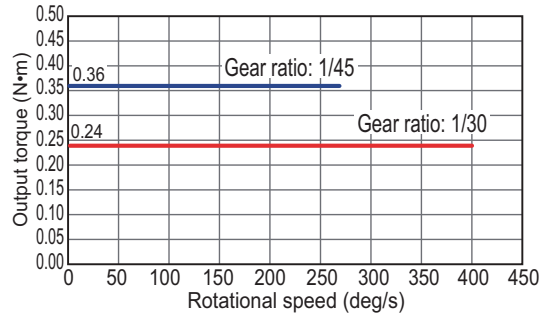

■ Correlation diagram of rotational speed and allowable inertial moment

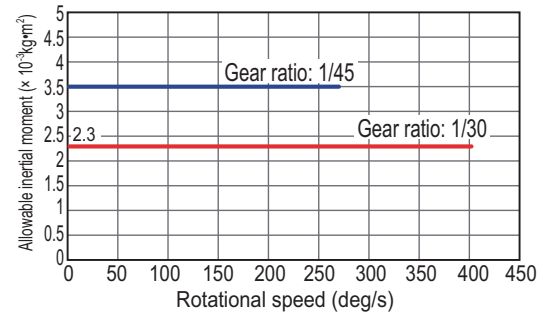

RCP2-RTB/RTBL

■ Correlation diagram of rotational speed and output torque

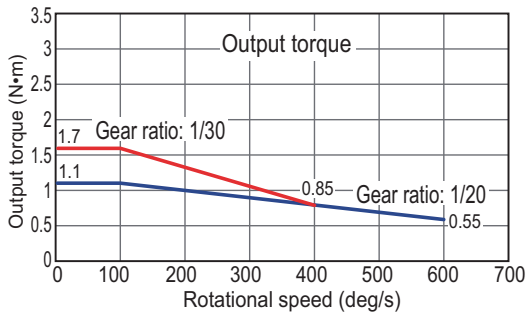

■ Correlation diagram of rotational speed and allowable inertial moment

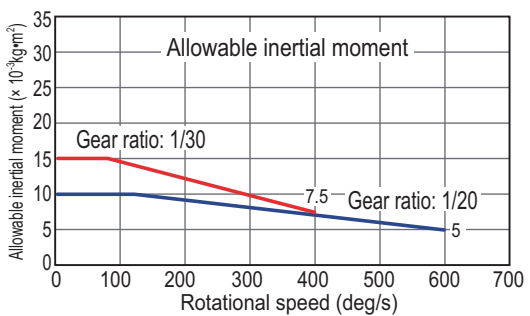

RCP2-RTC/RTCL

■ Correlation diagram of rotational speed and output torque

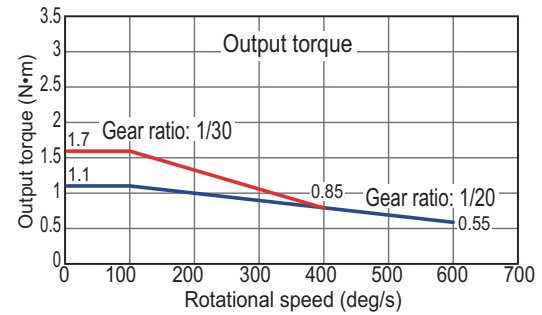

■ Correlation diagram of rotational speed and allowable inertial moment

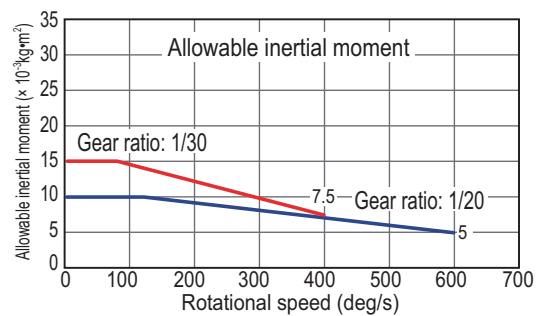

RCP2 Series (Rotary type)

* Characteristics should be the same for Cleanroom type.

RCP2-RTBB/RTBBL

■ Correlation diagram of rotational speed and output torque

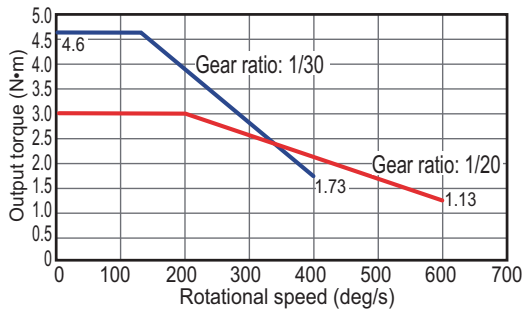

■ Correlation diagram of rotational speed and allowable inertial moment

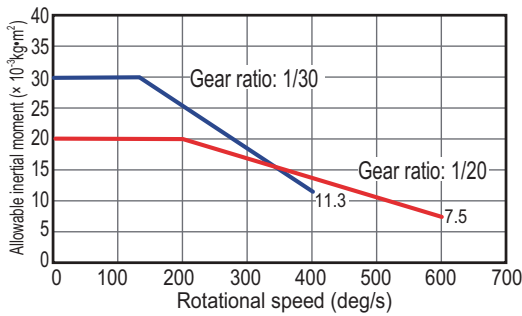

RCP2-RTCBL/RTCBL

■ Correlation diagram of rotational speed and output torque

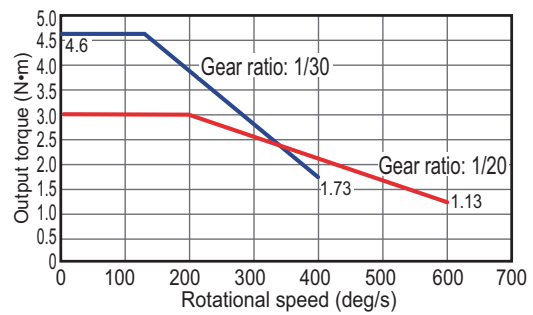

■ Correlation diagram of rotational speed and allowable inertial moment

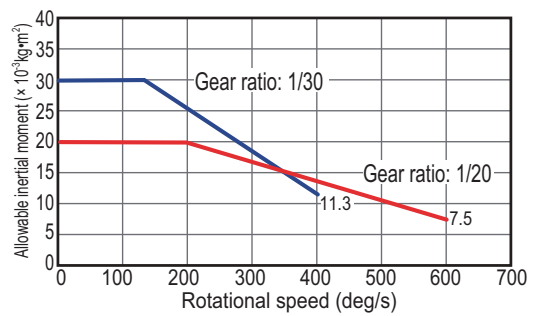

9.7 List of Actuators That Support Information Management Function

RCP6-SA4C-WA
RCP6-SA6C-WA
RCP6-SA7C-WA
RCP6-SA8C-WA

RCP6-WSA10C-WA
RCP6-WSA12C-WA
RCP6-WSA14C-WA
RCP6-WSA16C-WA

RCP6-TA4C-WA
RCP6-TA6C-WA
RCP6-TA7C-WA

RCP6-TA4R-WA
RCP6-TA6R-WA
RCP6-TA7R-WA

RCP6-SA4R-WA
RCP6-SA6R-WA
RCP6-SA7R-WA
RCP6-SA8R-WA

RCP6-WSA10R-WA
RCP6-WSA12R-WA
RCP6-WSA14R-WA
RCP6-WSA16R-WA

RCP6-TA4C-WA-DB
RCP6-TA6C-WA-DB
RCP6-TA7C-WA-DB

RCP6-TA4R-WA-DB
RCP6-TA6R-WA-DB
RCP6-TA7R-WA-DB

RCP6-RA4C-WA
RCP6-RA6C-WA
RCP6-RA7C-WA
RCP6-RA8C-WA

RCP6-RRA4C-WA
RCP6-RRA6C-WA
RCP6-RRA7C-WA
RCP6-RRA8C-WA

RCP6-WRA10C-WA
RCP6-WRA12C-WA
RCP6-WRA14C-WA
RCP6-WRA16C-WA

RCP6-RA4R-WA
RCP6-RA6R-WA
RCP6-RA7R-WA
RCP6-RA8R-WA

RCP6-RRA4R-WA
RCP6-RRA6R-WA
RCP6-RRA7R-WA
RCP6-RRA8R-WA

RCP6-WRA10R-WA
RCP6-WRA12R-WA
RCP6-WRA14R-WA
RCP6-WRA16R-WA

RCP6CR-SA4C-WA
RCP6CR-SA6C-WA
RCP6CR-SA7C-WA
RCP6CR-SA8C-WA

RCP6W-RA4C-WA
RCP6W-RA6C-WA
RCP6W-RA7C-WA
RCP6W-RA8C-WA

RCP6W-RRA4C-WA
RCP6W-RRA6C-WA
RCP6W-RRA7C-WA
RCP6W-RRA8C-WA

RCP6W-WRA10C-WA
RCP6W-WRA12C-WA
RCP6W-WRA14C-WA
RCP6W-WRA16C-WA

RCP6CR-WSA10C-WA
RCP6CR-WSA12C-WA
RCP6CR-WSA14C-WA
RCP6CR-WSA16C-WA

RCP6W-RA4R-WA
RCP6W-RA6R-WA
RCP6W-RA7R-WA
RCP6W-RA8R-WA

RCP6W-RRA4R-WA
RCP6W-RRA6R-WA
RCP6W-RRA7R-WA
RCP6W-RRA8R-WA

RCP6W-WRA10R-WA
RCP6W-WRA12R-WA
RCP6W-WRA14R-WA
RCP6W-WRA16R-WA

RCP6-GRT7A-WA
RCP6-GRT7B-WA

Chapter 10 Warranty

10.1 Warranty Period

One of the following periods, whichever is shorter:

- 18 months after shipment from our factory
- 12 months after delivery to a specified location

10.2 Scope of the Warranty

Our products are covered by warranty when all of the following conditions are met. Faulty products covered by warranty will be replaced or repaired free of charge:

- (1) The breakdown or problem in question pertains to our product as delivered by us or our authorized dealer.
- (2) The breakdown or problem in question occurred during the warranty period.
- (3) The breakdown or problem in question occurred while the product was in use for an appropriate purpose under the conditions and environment of use specified in the operation manual and catalog.
- (4) The breakdown or problem in question was caused by a specification defect or problem, or by the poor quality of our product.

Note that breakdowns due to any of the following reasons are excluded from the scope of warranty:

- [1] Anything other than our product
- [2] Modification or repair performed by a party other than us (unless we have approved such modification or repair)
- [3] Anything that could not be easily predicted with the level of science and technology available at the time of shipment from our company
- [4] A natural disaster, man-made disaster, incident or accident for which we are not liable
- [5] Natural fading of paint or other symptoms of aging
- [6] Wear, depletion or other expected result of use
- [7] Operation noise, vibration or other subjective sensation not affecting function or maintenance

Note that the warranty only covers our product as delivered and that any secondary loss arising from a breakdown of our product is excluded from the scope of warranty.

10.3 Honoring the Warranty

As a rule, the product must be brought to us for repair under warranty.

10.4 Limited Liability

- (1) We shall assume no liability for any special damage, consequential loss or passive loss such as a loss of expected profit arising from or in connection with our product.
- (2) We shall not be liable for any program or control method created by the customer to operate our product or for the result of such program or control method.

10.5 Conditions of Conformance with Applicable Standards/Regulations, Etc., and Applications

- (1) If our product is combined with another product or any system, device, etc., used by the customer, the customer must first check the applicable standards, regulations and/or rules. The customer is also responsible for confirming that such combination with our product conforms to the applicable standards, etc. In such a case we will not be liable for the conformance of our product with the applicable standards, etc.
- (2) Our product is for general industrial use. It is not intended or designed for the applications specified below, which require a high level of safety. Accordingly, as a rule our product cannot be used in these applications. Contact us if you must use our product for any of these applications:
 - [1] Medical equipment pertaining to maintenance or management of human life or health
 - [2] A mechanism or mechanical equipment intended to move or transport people (such as a vehicle, railway facility or aviation facility)
 - [3] Important safety parts of mechanical equipment (such as safety devices)
 - [4] Equipment used to handle cultural assets, art or other irreplaceable items
- (3) Contact us at the earliest opportunity if our product is to be used in any condition or environment that differs from what is specified in the catalog or operation manual.

10.6 Other Items Excluded from Warranty

The price of the product delivered to you does not include expenses associated with programming, the dispatch of engineers, etc. Accordingly, a separate fee will be charged in the following cases even during the warranty period:

- [1] Guidance for installation/adjustment and witnessing of test operation
- [2] Maintenance and inspection
- [3] Technical guidance and education on operating/wiring methods, etc.
- [4] Technical guidance and education on programming and other items related to programs

Change History

Revision Date	Revision Description
2016.01	First Edition
2016.03	1B Edition P20, 168 Change made to applicable teaching P231 Correct made e-CON model
2016.11	1C Edition [1], [2], ... added to Table of Contents Starting Procedures Ladder Edit Program deleted P11 Change made to International Standards Compliance P19 Note added in remark of 5 Dummy Plug saying "Only when PCON-CGB/CGFB" P21, 157, 219 MECHATROLINK-III added P22 Rated load current for PCON-CFB/CGFB deleted P23 Note added stating weight of battery and battery case should be added for simple absolute type P47, 61, 205 RCP6 added P65 Correct made from BKRLS to BK P71, 73 Figure swapped P80 Caution note added for first order lag filter P90 Note added stating detection range of zone signal depends on number of encoder pulse Note added stating it differs depending on models P107, 122 Explanation added for TRQS signal timing change P114 Change made to Description 4) ON → OFF P115 ST1 to ST6 → ST0 to ST6, PE1 to PE6 → PE0 to PE6 P147, 148 Table added and corrected for binary output in [10] Binary Output of Alarm Data Output P154 [3] Pulse Train Datum Position added P166 6.2 Automatic Current Reduction Feature added P179 Signal changed to ○ in "For Pulse Train Mode" in high-output setting No. 182 Automatic current reduction feature select added P179, 208 Pulse train datum position range changed from 0 to 9999.99 to -9999.99 to 9999.99 Others Correction made
2018.02	1D Edition P24 to 29 Correction made to dimensions in Appearance P49 Correction made to signal names for 8B and 9B in PIO Pattern 1 P42, 128 Explanation added for ST0 and TRQS Signals in Solenoid Valve Mode 2 P9, 265 Note added and changed in cause for Pulse Train Control Mode P138, 153 Note added for velocity setting at pressing operation in pulse train control P180, 203, 206 Correction made to parameters at delivery for Parameter No. 112 and No. 152 P225, 230 Note changed in Cause/Treatment for Alarm Code 0A3 and 0E5 P241 Correction made to TP adapter and connector numbers General Applicable for TB-02 and TB-03 Others Correction made, terms unified

POWER CON PCON-CB

Revision Date	Revision Description
2018.08	1E Edition Correction made to Applicable Connection Cable Model Codes in 2.1.3 [2]
2018.08	1F Edition Correction made to Applicable Connection Cable Model Codes in 2.2.3 [2]
2018.10	Second Edition General CC-Link IE Field added Column for "Symbol" deleted from Parameter List 8.1 Parameters No. 187 and No. 188 added 8.2 Description added for details of Parameters No. 10, No. 182, No. 187 and No. 188 9.4 Example added for occurrence of Alarm 0A1 10.6 List of Specifications of Connectable Actuators revised Others Correction made, terms unified
2019.02	2B Edition 2.1, 2.2 Change made to description regarding wiring at power supply connector 2.3 View of connector on controller side for motor/encoder cable added 3.2.6 Change made to description regarding operation in PIO Pattern 5 (Electromagnetic Valve Mode 2) 6.1 Description changed in Note 1 for Automatic Servo-off and Full Servo Functions 7.2 Section deleted for absolute battery voltage drop detection Description added for battery replacement when using absolute battery unit 8.1, 8.2 Correction made to Parameters No. 5, 6, 35, 48, 145, 149 and 151 8.2 Description added for details of Parameters No. 166 9.4 Example added for occurrence of Alarm 05C and 05E Note changed in Cause/Treatment for Alarm 0CE 10.2 View and dimensions added for dummy plug (DP-4S) 10.6 List of Specifications of Connectable Actuators revised Others Correction made, terms unified
2019.05	Third Edition General Chapter 5 and 6 integrated Precautions in Operation Contents added and changed in Item 10 2.1 Change made to description regarding LOAD/TRQS Signal 3.2 Description changed in Command Torque Level Detection at Pressing 5.3 Contents added in Actuator Information Management Function 7.1, 7.2 Correction made to Parameters No. 31, 32, 50, 51, 110, 143, 145, 146, 151, 153, 154 and 156, No. 192 added 8.4 Alarm 09C added, example added for occurrence of Alarm 0A1 Note changed in Cause/Treatment for Alarm 0D4, 0E0 and 0E5 9.6 List of Specifications of Connectable Actuators revised 9.7 List of Actuators That Support Information Management Function added Others Correction made, terms unified

Revision Date	Revision Description
2019.08	3B Edition Precautions in Operation Contents added in Item 14 3.2.1 Note added 5.2.1 Description changed in Note 1 8.2.2 Situation "Positioning of poor precision" 2) added in Cause/Check/Treatment





IAI Corporation

Head Office: 577-1 Obane Shimizu-KU Shizuoka City Shizuoka 424-0103, Japan
TEL +81-54-364-5105 FAX +81-54-364-2589
website: www.iai-robot.co.jp/

Technical Support available in USA, Europe and China

IAI America, Inc.

Head Office: 2690 W. 237th Street, Torrance, CA 90505
TEL (310) 891-6015 FAX (310) 891-0815
Chicago Office: 110 East State Parkway, Schaumburg, IL 60173
TEL(847) 908-1400 FAX (847) 908-1399
Atlanta Office: 1220 Kennestone Circle, Suite 108, Marietta, GA 30066
TEL (678) 354-9470 FAX (678) 354-9471
website: www.intelligentactuator.com

IAI Industrieroboter GmbH

Ober der Röth 4, D-65824 Schwalbach am Taunus, Germany
TEL 06196-88950 FAX 06196-889524
website: www.iai-gmbh.de

IAI (Shanghai) Co., Ltd.

SHANGHAI JIAHUA BUSINESS CENTER A8-303, 808, Hongqiao Rd. Shanghai 200030, China
TEL 021-6448-4753 FAX 021-6448-3992
website: www.iai-robot.com

IAI Robot (Thailand) Co., Ltd.

825, PhairojKijja Tower 7th Floor, Debaratana RD., Bangna-Nuea, Bangna, Bangkok 10260, Thailand
TEL +66-2-361-4458 FAX +66-2-361-4456
website: www.iai-robot.co.th