

Cleanroom Gripper Type

**RCP2CR-GR**

Dust-proof Gripper Type

**RCP2W-GR**

Cleanroom

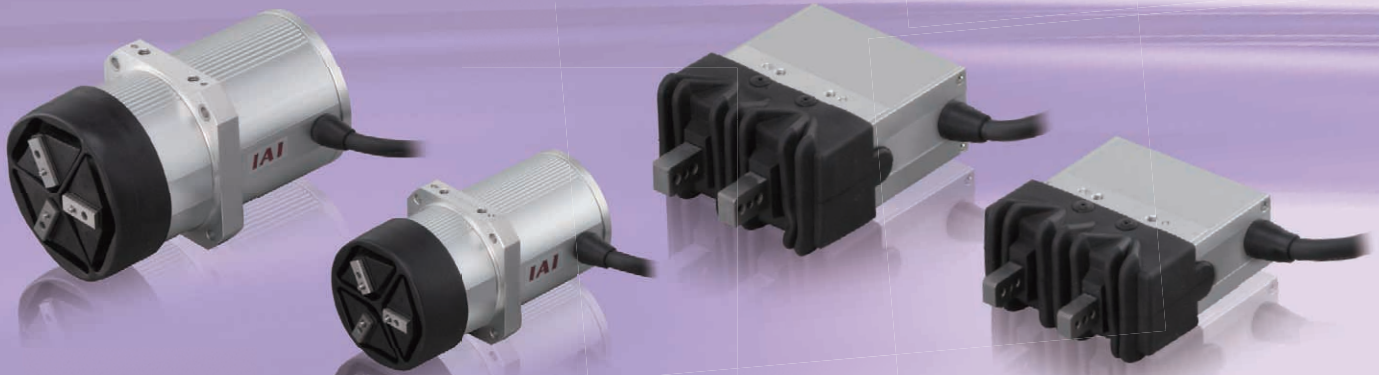

Dust-proof

# Cleanroom Type **Class 10** and Dust-proof Type **IP50** are now added to the lineup of the Two-fingered gripper RCP2-GRS/GRM and Three-fingered gripper RCP2-GR3SS/GR3SM series

## Features

### 1 Cleanroom Type and Dust-proof Type Available

Cleanroom Type and Dust-proof Type are added to the gripper slider type. They are optimized for gripper use in cleanrooms and dusty environments.

Supporting

Clean Class 10

Supporting

IP50

#### What is Cleanliness

Class 100 and Class 10 are examples of the unit of the cleanliness. Class 10 (0.1 $\mu$ m) indicates an environment with 10 pieces of dust or less that are 0.1 $\mu$ m or larger in a 1ft<sup>3</sup> area.

#### What is IP

Degree of Protection IP



1<sup>st</sup> Number

Protection against human and solid particle

2<sup>nd</sup> Number

Protection against water entry

It is the class specified in IEC standards for water proof and dust proof.

<b>IP50</b>	Solid Particle	Ingress of dust is not entirely prevented, but does not enter in sufficient quantity to interfere with the satisfactory operation of the equipment.
	Water	No protection provided against liquid.

### 2 Upgraded Rigidity

By improving the structure of the base guide, fingers of RCP2□-GRS/RCP2□-GRM series have double backlash resistance against the load moment than the resistance of previous series. Situation assumes that a transient load exceeding the allowable load moment is being applied.

Measurement of backlash versus the moment load applied to the gripper fingers.

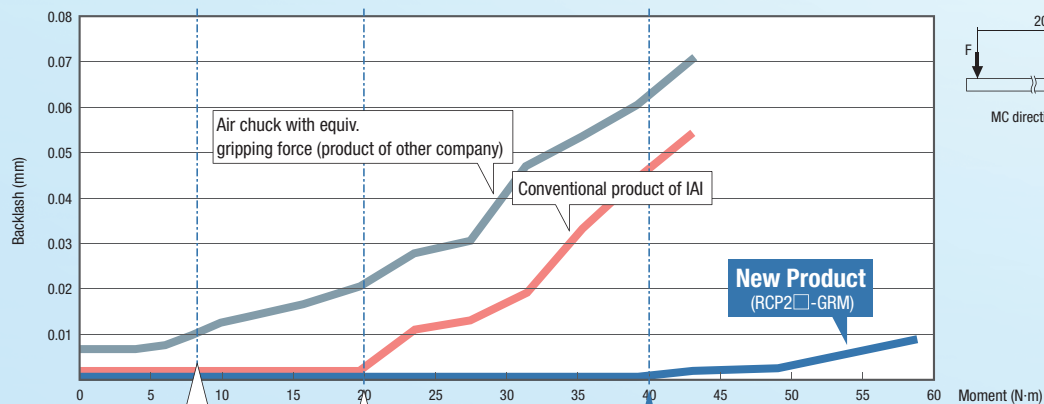

**Allowable 8.3N·m** (For RCP2□-GRM)  
It is the allowable value of moment applied by gripping operation.

Backlash generated with three times the allowable moment on conventional product

No backlash generated until five times the allowable moment of the new product is applied

<Note> Loads shown in the graph are not the allowable load. Applying a load exceeding the allowable moment might fault out the actuator which may significantly reduce product life or cause malfunction.

### 3 Supporting Multi-point Positioning, Adjustable Gripping Force

Up to 512 positioning points are supported via servo control, and the gripping force is adjustable.

This makes it easy to adjust the finger opening/closing width at setup change and to grip easy-to-deform work parts.

## Product Lineup

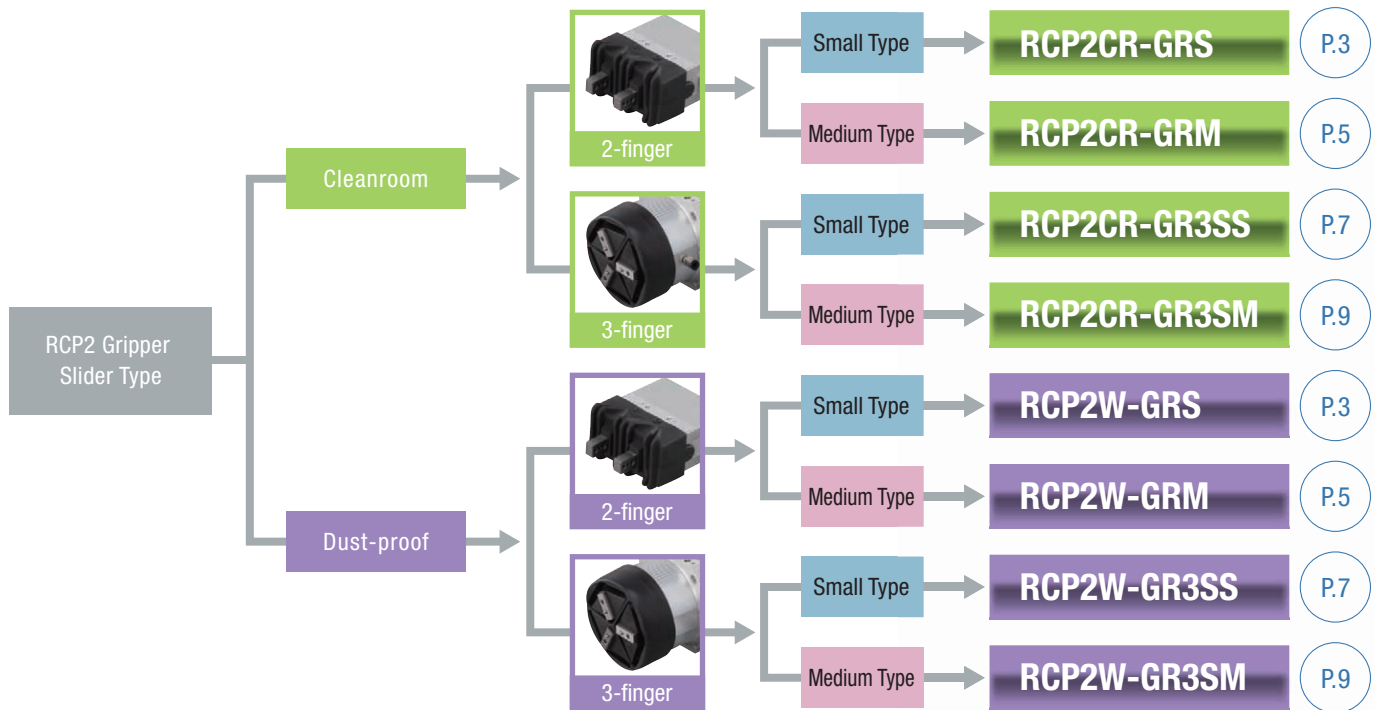

## Product Specification

Specification	Series	Number of Fingers	Type	External View	Gripper Width (mm)	Opening/Closing Stroke (mm)	Max. Gripping Force (N)	See Page
Cleanroom	RCP2CR	2-finger	GRS		74	10 (5 per finger)	21 (10.5 per finger)	P.3
			GRM		79	14 (7 per finger)	80 (40 per finger)	P.5
		3-finger	GR3SS		62	10 (5 per finger)	22 (7.3 per finger)	P.7
			GR3SM		80	14 (7 per finger)	102 (34 per finger)	P.9
Dust-proof	RCP2W	2-finger	GRS		74	10 (5 per finger)	21 (10.5 per finger)	P.3
			GRM		79	14 (7 per finger)	80 (40 per finger)	P.5
		3-finger	GR3SS		62	10 (5 per finger)	22 (7.3 per finger)	P.7
			GR3SM		80	14 (7 per finger)	102 (34 per finger)	P.9

# RCP2CR-GRS

Cleanroom ROBO Cylinder, 2-finger Gripper, Small Slider Type, 74mm Width, Pulse Motor

# RCP2W-GRS

Dust-proof ROBO Cylinder, 2-finger Gripper, Small Slider Type, 74mm Width, Pulse Motor

Model Specification Items	RCP2CR RCP2W Series	GRS Type	I Encoder	20P Motor	1 Deceleration Ratio	10 Opening/ Closing Stroke	Applicable Controllers	Cable Length	Options
	RCP2CR: Cleanroom RCP2W : Dust-proof		I: Incremental	20P: Pulse motor 20□size	1: Deceleration ratio 1/1	10: 10mm (5mm per finger)	P1: PCON-PL/PO/SE PSEL P3: PCON-CA PMEC/PSEP MSEP	N: None P: 1m S: 3m M: 5m X□□ : Custom R□□ : Robot cable	FB: Flange bracket SB: Shaft bracket VL: L-shaped vacuum joint specification

RoHS

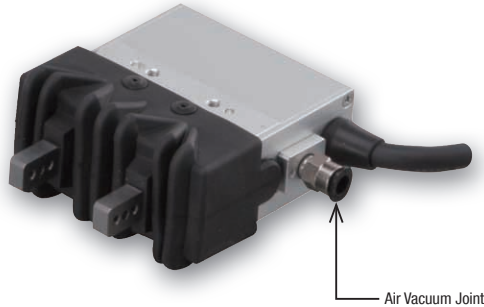

Air Vacuum Joint

\* The figure above shows the Cleanroom Type.  
There is no air vacuum joint equipped on the Dust-proof Type.

**POINT**  
Note on selection

- (1) The maximum opening/closing speed indicates the operating speed on one side. The relative operating speed is twice this value.
- (2) The maximum gripping force is the sum of the gripping forces of both fingers, at a gripping point where there is no offset or overhang distance. The work part weight that can be actually moved depends on the friction coefficient between the gripper fingers and the work part, as well as on the shape of the work part. As a rough guide, a work part's weight should not exceed 1/10 to 1/20 of the gripping force.  
\* The gripping point O should be the center of mass in the drawing.
- (3) Refer to "How to Select Gripper" at the end of the ROBO Cylinder General Catalog for how to select a gripper.
- (4) The rated acceleration while moving is 0.3G.

### Correlation Diagram of Gripping Force and Electric Current Limit

By pressing motion, the gripping (pushing) force can be adjusted freely within the range of electric current limits of 20% to 70%.

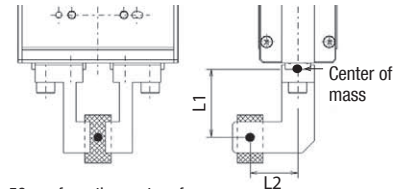

- \* Keep L1 within 50mm from the center of mass.
- \* The gripping force in the graph below assumes that L1 and L2 in the figure above are zero. Also note that the gripping force is a sum of gripping forces of both fingers.

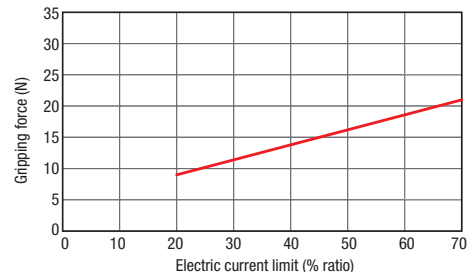

\* The gripping force graph above shows reference numbers. Please allow margins up to ±15%.

\* Please note that, when gripping (pushing), the speed is fixed at 5mm/s.

### Actuator Specifications

#### Max. Gripping Force and Stroke

Model Number	Deceleration Ratio	Max. Gripping Force (N)	Stroke (mm)
RCP2CR-GRS-I-20P-1-10-①-②-③	1	21	10
RCP2W-GRS-I-20P-1-10-①-②-③		(10.5 per finger)	(5 per finger)

Legend: ① Applicable controllers ② Cable length ③ Options

#### Stroke and Max. Opening/Closing Speed / Suction Amount

Deceleration Ratio	Stroke	10 (mm)	Suction Amount (*)
1		33.3mm/s (Per finger)	10Nℓ/min

\* For Cleanroom Type

#### Stroke

Stroke (mm)	Specification	Standard Price
10	Cleanroom	—
	Dust-proof	—

#### ② Cable Length

Type	Cable Code	Standard Price	
		Applicable Controller Code	
		P3	P1
Standard Type	P (1m)	—	—
	S (3m)	—	—
	M (5m)	—	—
Special Length	X06 (6m) ~ X10 (10m)	—	—
	X11 (11m) ~ X15 (15m)	—	—
	X16 (16m) ~ X20 (20m)	—	—
Robot Cable	R01 (1m) ~ R03 (3m)	—	Robot cable is standard for P1
	R04 (4m) ~ R05 (5m)	—	
	R06 (6m) ~ R10 (10m)	—	
	R11 (11m) ~ R15 (15m)	—	
	R16 (16m) ~ R20 (20m)	—	
		—	

#### ③ Options

Name	Option Code	Standard Price
Flange Bracket	FB	—
Shaft Bracket	SB	—
L-shaped Vacuum Joint Specification (Cleanroom Only)	VL	—

#### <Option Code>

FB...Bracket only: RCP2-FB-GRS

SB...Bracket only: RCP2-SB-GRS

\* Check the size of the bracket in the option explanation at the end of the ROBO Cylinder General Catalog.

#### Actuator Specifications

Item	Description	
	Cleanroom	Dust-proof
Series		
Drive System	Timing belt + trapezoidal screw (1.5 lead)	
Positioning Repeatability	±0.01mm	
Backlash	0.15mm or less per finger (constantly pressed out by a spring)	
Lost Motion	0.1mm or less per finger	
Allowable Static Load Moment	Ma: 6.3N·m Mb: 6.3N·m Mc: 7.0N·m	
Guide	Cross roller guide	
Cleanliness	Class 10 (0.1μm)	
IP Code	— IP50	
Weight	0.42kg	
Operating Environment	Temperature 0~40°C Humidity 20~85% RH or less (non-condensing)	

## Dimensions

CAD drawings can be downloaded from the website.

www.intelligentactuator.com

2D CAD

3D CAD

- \* The opening side of the slider is the home position.
- \* Shown below is a drawing for the Cleanroom Type. There is no air vacuum joint equipped on the Dust-proof Type.
- \* The actuator pigtail is not a robot cable.

### Note

\* Utilize  $\phi 3H7$  through hole for positioning of fingers.

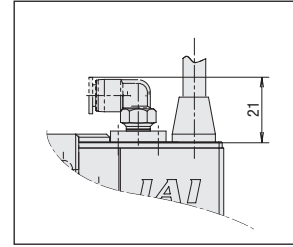
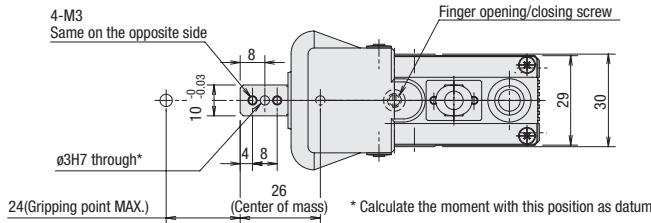

L-shaped vacuum joint specification

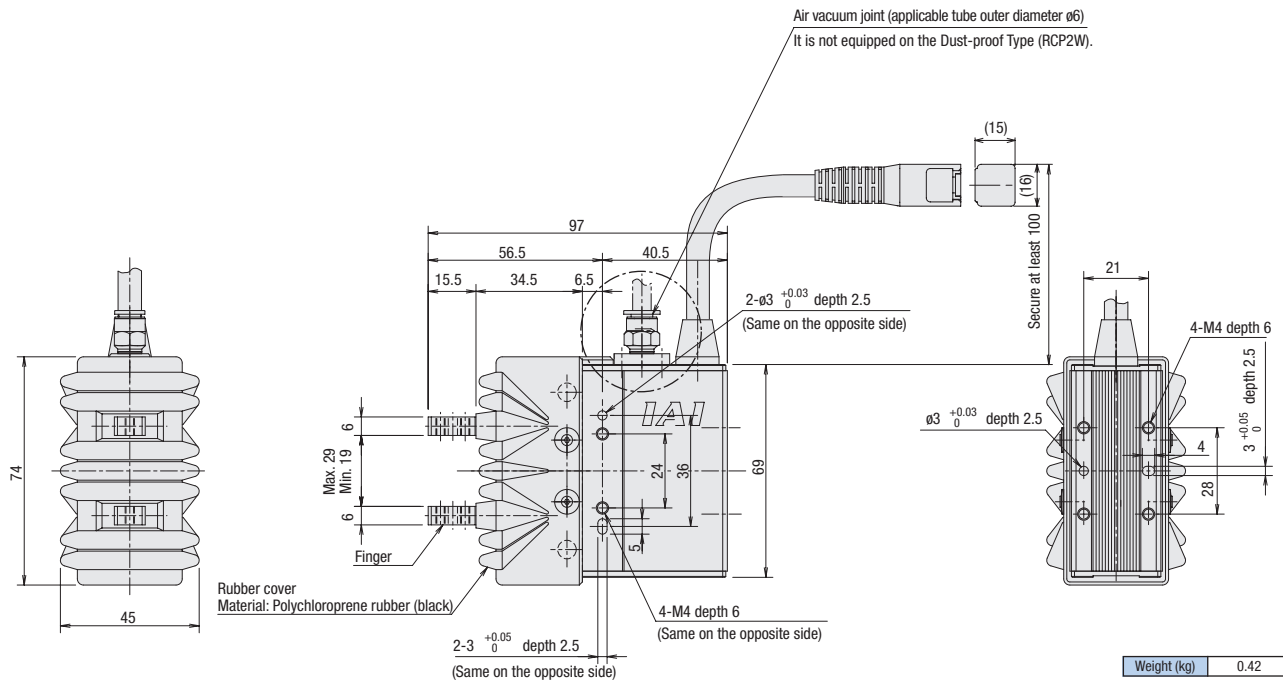

## ① Applicable Controllers

The RCP2 series actuators can operate with the controllers below. Select the controller according to your usage.

Name	External View	Model Number	Features	Max. Pos. Points	Input Voltage	Power Supply Capacity	Standard Price
Solenoid Valve Multi-axis Type (PIO Specification)		MSEP-①-③-④-①-2-0	Positioner type based on PIO control, allowing up to 8 axes to be connected	3 points	DC24V	See ROBO Cylinder General Catalog	-
Solenoid Valve Multi-axis Type (Network Specification)		MSEP-①-③-④-⑤-0-0	Field network ready positioner type, allowing up to 8 axes to be connected	256 points			-
Positioner Type High-output Specification		PCON-CA-20P①-①-2-0	Equipped with high-output driver Positioner type based on PIO control	512 points			-
Pulse Train Type High-output Specification		PCON-CA-20PWA-PL□-2-0	Equipped with high-output driver Pulse train input type	-			-
Network Type High-output Specification		PCON-CA-20P①-④-0-0	Equipped with a high-output driver Supports 8 major field networks	768 points			-
Pulse Train Type (Differential Line Driver Specification)		PCON-PL-20PI-①-2-0	Pulse train input type with differential line driver support	-			-
Pulse Train Type (Open Collector Specification)		PCON-PO-20PI-①-2-0	Pulse train input type with open collector support				-
Serial Communication Type		PCON-SE-20PI-N-0-0	Dedicated serial communication	64 points			-
Program Control Type		PSEL-CS-1-20PI-①-2-0	Program operation is possible for up to 2 axes	1500 points	-		

\* This is for the single-axis PSEL.

\* ① indicates I/O type (NP/PM).

\* ③ indicates C/LC type. Up to 6 axes can be connected if LC is selected.

\* □ indicates N (NPN specification) or P (PNP specification) code.

\* ④ indicates number of axes (1~8).

\* ⑤ indicates field network specification code.

\* ④ indicates N (NPN specification) or P (PNP specification) code.

# RCP2CR-GRM

Cleanroom ROBO Cylinder, 2-finger Gripper, Medium Slider Type, 79mm Width, Pulse Motor

# RCP2W-GRM

Dust-proof ROBO Cylinder, 2-finger Gripper, Medium Slider Type, 79mm Width, Pulse Motor

<b>Model Specification Items</b>	<b>RCP2CR</b> RCP2W	<b>GRM</b>	<b>I</b>	<b>28P</b>	<b>1</b>	<b>14</b>			
<b>Series</b>	RCP2CR: Cleanroom RCP2W: Dust-proof	<b>Type</b>	<b>Encoder</b>	<b>Motor</b>	<b>Deceleration Ratio</b>	<b>Opening/Closing Stroke</b>	<b>Applicable Controllers</b>	<b>Cable Length</b>	<b>Options</b>
			I: Incremental	28P: Pulse motor 28□size	1: Deceleration ratio 1/1	14: 14mm (7mm per finger)	P1: PCON-PL/PO/SE PSEL P3: PCON-CA PMEC/PSEP MSEP	N: None P: 1m S: 3m M: 5m X□□: Custom R□□: Robot cable	FB: Flange bracket SB: Shaft bracket VL: L-shaped vacuum joint specification

RoHS

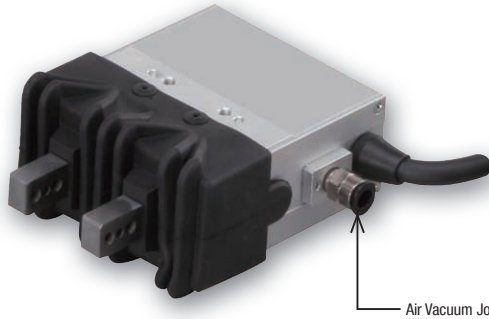

Air Vacuum Joint

\* The figure above shows the Cleanroom Type.  
There is no air vacuum joint equipped on the Dust-proof Type.

**POINT**  
Note on selection

- The maximum opening/closing speed indicates the operating speed on one side. The relative operating speed is twice this value.
- The maximum gripping force is the sum of the gripping forces of both fingers, at a gripping point where there is no offset or overhang distance. The work part weight that can be actually moved depends on the friction coefficient between the gripper fingers and the work part, as well as on the shape of the work part. As a rough guide, a work part's weight should not exceed 1/10 to 1/20 of the gripping force.
- \* The gripping point O should be the center of mass in the drawing.
- Refer to "How to Select Gripper" at the end of the ROBO Cylinder General Catalog for how to select a gripper.
- The rated acceleration while moving is 0.3G.

### Correlation Diagram of Gripping Force and Electric Current Limit

By pressing motion, the gripping (pushing) force can be adjusted freely within the range of electric current limits of 20% to 70%.

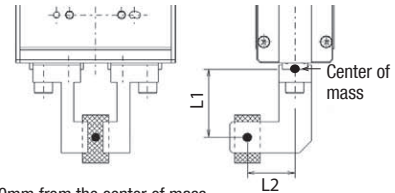

- \* Keep L1 within 80mm from the center of mass.
- \* The gripping force in the graph below assumes that L1 and L2 in the figure above are zero. Also note that the gripping force is a sum of gripping forces of both fingers.

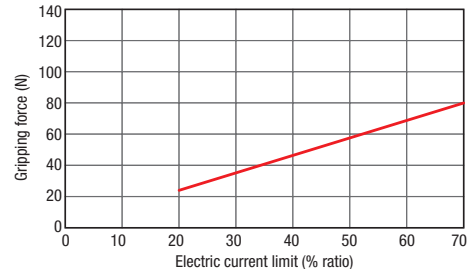

\* The gripping force graph above shows reference numbers. Please allow margins up to ±15%.

\* Please note that, when gripping (pushing), the speed is fixed at 5mm/s.

### Actuator Specifications

#### Max. Gripping Force and Stroke

Model Number	Deceleration Ratio	Max. Gripping Force (N)	Stroke (mm)
RCP2CR-GRM-I-28P-1-14-①-②-③	1	80	14
RCP2W-GRM-I-28P-1-14-①-②-③		(40 per finger)	(7 per finger)

Legend: ① Applicable controllers ② Cable length ③ Options

#### Stroke and Max. Opening/Closing Speed / Suction Amount

Deceleration Ratio	Stroke	10 (mm)	Suction Amount (*)
1		36.7mm/s (Per finger)	10Nℓ/min

\* For Cleanroom Type

#### Stroke

Stroke (mm)	Specification	Standard Price
14	Cleanroom	—
	Dust-proof	—

#### ② Cable Length

Type	Cable Code	Standard Price	
		Applicable Controller Code	
		P3	P1
Standard Type	P (1m)	—	—
	S (3m)	—	—
	M (5m)	—	—
Special Length	X06 (6m) ~ X10 (10m)	—	—
	X11 (11m) ~ X15 (15m)	—	—
	X16 (16m) ~ X20 (20m)	—	—
Robot Cable	R01 (1m) ~ R03 (3m)	—	Robot cable is standard for P1
	R04 (4m) ~ R05 (5m)	—	
	R06 (6m) ~ R10 (10m)	—	
	R11 (11m) ~ R15 (15m)	—	
	R16 (16m) ~ R20 (20m)	—	
		—	

#### ③ Options

Name	Option Code	Standard Price
Flange Bracket	FB	—
Shaft Bracket	SB	—
L-shaped Vacuum Joint Specification (Cleanroom Only)	VL	—

#### <Option Code>

FB...Bracket only: RCP2-FB-GRM

SB...Bracket only: RCP2-SB-GRM

\* Check the size of the bracket in the option explanation at the end of the ROBO Cylinder General Catalog.

#### Actuator Specifications

Item	Description	
	Cleanroom	Dust-proof
Drive System	Timing belt + trapezoidal screw (1.5 lead)	
Positioning Repeatability	±0.01mm	
Backlash	0.15mm or less per finger (constantly pressed out by a spring)	
Lost Motion	0.1mm or less per finger	
Allowable Static Load Moment	Ma: 6.3N·m Mb: 6.3N·m Mc: 8.3N·m	
Guide	Cross roller guide	
Cleanliness	Class 10 (0.1μm)	
IP Code	— IP50	
Weight	0.62kg	
Operating Environment	Temperature 0~40°C Humidity 20~85% RH or less (non-condensing)	

## Dimensions

CAD drawings can be downloaded from the website.

www.intelligentactuator.com

2D CAD

3D CAD

- \* The opening side of the slider is the home position.
- \* Shown below is a drawing for the Cleanroom Type. There is no air vacuum joint equipped on the Dust-proof Type.
- \* The actuator pigtail is not a robot cable.

### Note

\* Utilize  $\phi 3H7$  through hole for positioning of fingers.

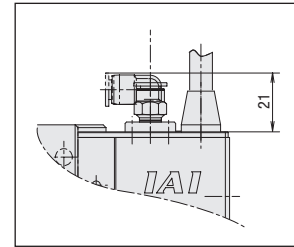
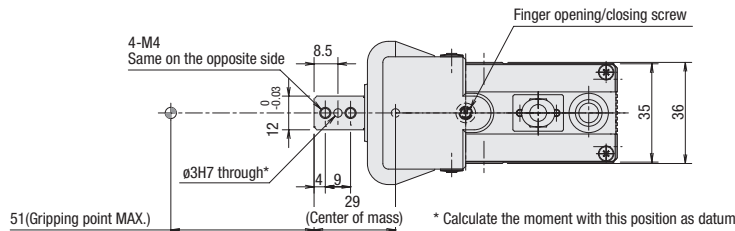

L-shaped vacuum joint specification

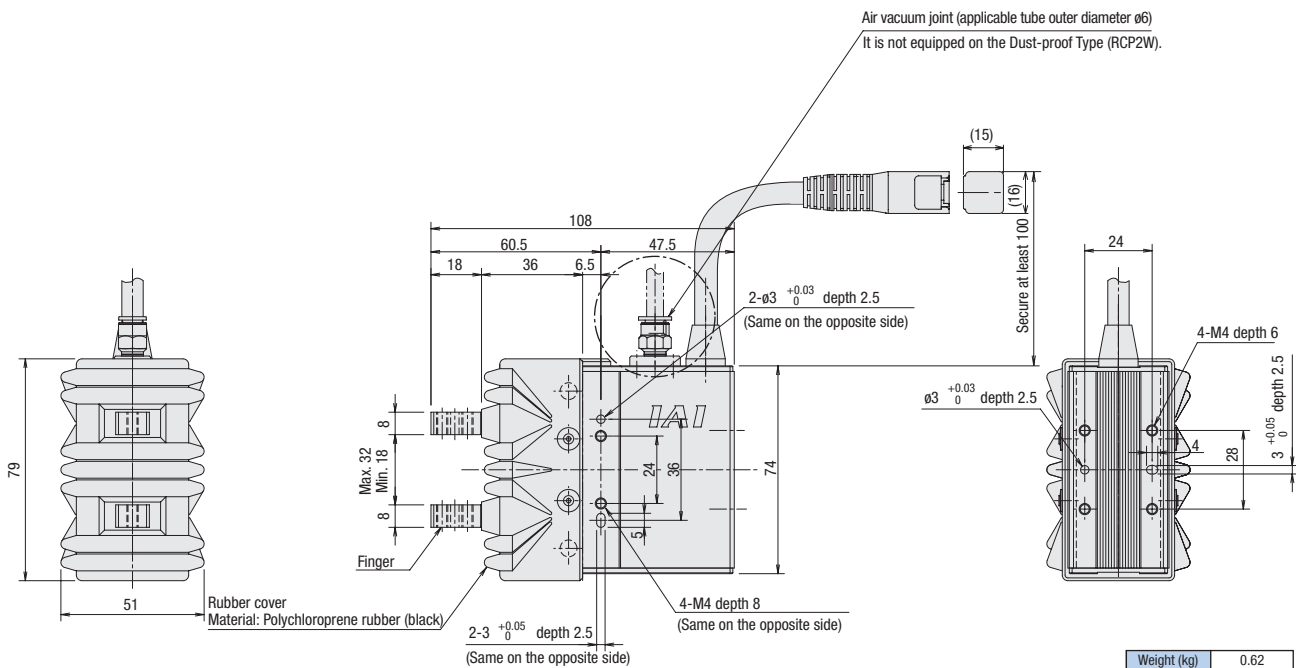

## ① Applicable Controllers

The RCP2 series actuators can operate with the controllers below. Select the controller according to your usage.

Name	External View	Model Number	Features	Max. Pos. Points	Input Voltage	Power Supply Capacity	Standard Price
Solenoid Valve Multi-axis Type (PIO Specification)		MSEP-( $\text{I}$ )-(M)- $\text{---}$ ( $\text{I}$ )-2-0	Positioner type based on PIO control, allowing up to 8 axes to be connected	3 points	DC24V	See ROBO Cylinder General Catalog	-
Solenoid Valve Multi-axis Type (Network Specification)		MSEP-( $\text{I}$ )-(M)- $\text{---}$ ( $\text{W}$ )-0-0	Field network ready positioner type, allowing up to 8 axes to be connected	256 points			-
Positioner Type High-output Specification		PCON-CA-28P( $\text{V}$ )-( $\text{I}$ )-2-0	Equipped with high-output driver Positioner type based on PIO control	512 points			-
Pulse Train Type High-output Specification		PCON-CA-28PWA-PL( $\square$ )-2-0	Equipped with high-output driver Pulse train input type	-			-
Network Type High-output Specification		PCON-CA-28P( $\text{V}$ )-( $\text{W}$ )-0-0	Equipped with a high-output driver Supports 8 major field networks	768 points			-
Pulse Train Type (Differential Line Driver Specification)		PCON-PL-28PI-( $\text{I}$ )-2-0	Pulse train input type with differential line driver support	-			-
Pulse Train Type (Open Collector Specification)		PCON-PO-28PI-( $\text{I}$ )-2-0	Pulse train input type with open collector support				-
Serial Communication Type		PCON-SE-28PI-N-0-0	Dedicated serial communication	64 points			-
Program Control Type		PSEL-CS-1-28PI-( $\text{I}$ )-2-0	Program operation is possible for up to 2 axes	1500 points	-		

\* This is for the single-axis PSEL.

\* ( $\text{I}$ ) indicates I/O type (NP/PM).

\* (M) indicates C/LC type. Up to 6 axes can be connected if LC is selected.

\* ( $\square$ ) indicates N (NPN specification) or P (PNP specification) code.

\* (1-8) indicates number of axes (1-8).

\* (W) indicates field network specification code.

\* (V) indicates encoder type. Enter WAI for incremental specification and SA for simple absolute specification.

# RCP2CR-GR3SS

Cleanroom ROBO Cylinder, 3-finger Gripper, Slider Type, 62mm Width, Pulse Motor

# RCP2W-GR3SS

Dust-proof ROBO Cylinder, 3-finger Gripper, Slider Type, 62mm Width, Pulse Motor

<b>Model Specification Items</b> RCP2CR: Cleanroom RCP2W : Dust-proof	<b>RCP2CR</b> <b>RCP2W</b> Series	<b>GR3SS</b> Type	<b>I</b> Encoder	<b>28P</b> Motor	<b>30</b> Deceleration Ratio	<b>10</b> Opening/Closing Stroke	Applicable Controllers P1: PCON-PL/PO/SE PSEL P3: PCON-CA PMEC/PSEP MSEP	Cable Length N: None P: 1m S: 3m M: 5m X□□ : Custom R□□ : Robot cable	Options FB: Flange bracket SB: Shaft bracket VL: L-shaped vacuum joint specification
---	---	----------------------	---------------------	---------------------	---------------------------------	-------------------------------------	---	---	---

RoHS



\* The figure above shows the Cleanroom Type.  
There is no air vacuum joint equipped on the Dust-proof Type.

- POINT**  
Note on selection
- (1) The maximum gripping force is the sum of gripping forces of all fingers at gripping point O (\*) and with overhang distance O. For the actual transportable work part weight, refer to the explanation to the right.  
\* The gripping point O should be the center of mass in the drawing.
  - (2) Refer to "How to Select Gripper" at the end of the ROBO Cylinder General Catalog for how to select a gripper.
  - (3) The rated acceleration while moving is 0.3G.

### Correlation Diagram of Gripping Force and Electric Current Limit

By pressing motion, the gripping (pushing) force can be adjusted freely within the range of electric current limits of 20% to 70%.

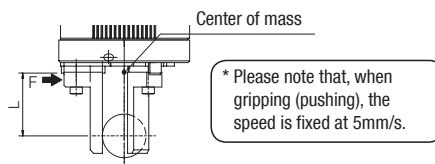

- \* Keep L within 50mm from the center of mass.
- \* The gripping force in the graph below assumes that L in the figure above is zero. Also note that the gripping force is a sum of gripping forces of all fingers.

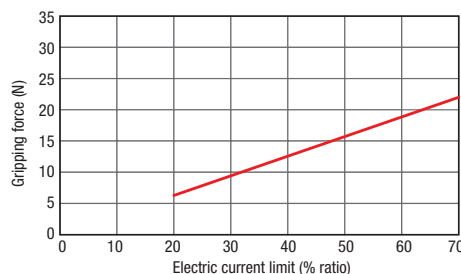

\* The gripping force graph above shows reference numbers. Please allow margins up to ±15%.

### Actuator Specifications

#### Max. Gripping Force and Stroke

Model Number	Deceleration Ratio	Max. Gripping Force (N)	Stroke (mm)
RCP2CR-GR3SS-I-28P-30-10-①-②-③	30	22	10
RCP2W-GR3SS-I-28P-30-10-①-②-③		(7.3 per finger)	(5 per finger)

Legend: ① Applicable controllers ② Cable length ③ Options

#### Stroke and Max. Opening/Closing Speed / Suction Amount

Deceleration Ratio	Stroke	10 (mm)	Suction Amount (*)
30		40mm/s	10Nℓ/min

\* For Cleanroom Type

#### Stroke

Stroke (mm)	Specification	Standard Price
10	Cleanroom	—
	Dust-proof	—

#### ② Cable Length

Type	Cable Code	Standard Price	
		Applicable Controller Code	
		P3	P1
Standard Type	P (1m)	—	—
	S (3m)	—	—
	M (5m)	—	—
Special Length	X06 (6m) ~ X10 (10m)	—	—
	X11 (11m) ~ X15 (15m)	—	—
	X16 (16m) ~ X20 (20m)	—	—
Robot Cable	R01 (1m) ~ R03 (3m)	—	Robot cable is standard for P1
	R04 (4m) ~ R05 (5m)	—	
	R06 (6m) ~ R10 (10m)	—	
	R11 (11m) ~ R15 (15m)	—	
	R16 (16m) ~ R20 (20m)	—	
		—	

#### ③ Options

Name	Option Code	Standard Price
Flange Bracket	FB	—
Shaft Bracket	SB	—
L-shaped Vacuum Joint Specification (Cleanroom Only)	VL	—

#### <Option Code>

FB...Bracket only: RCP2-FB-GR3S

SB...Bracket only: RCP2-SB-GR3S

\* Check the size of the bracket in the option explanation at the end of the ROBO Cylinder General Catalog.

#### Actuator Specifications

Item	Description	
	Cleanroom	Dust-proof
Drive System	Worm gear + Worm wheel gear	
Positioning Repeatability	±0.01mm	
Backlash	0.3mm or less per finger (constantly pressed out by a spring)	
Lost Motion	0.1mm or less per finger	
Allowable Static Load Moment	Ma: 3.8N·m Mb: 3.8N·m Mc: 3.0N·m	
Guide	Cross roller guide	
Cleanliness	Class 10 (0.1μm)	
IP Code	— IP50	
Weight	0.7kg	
Operating Environment	Temperature 0~40°C Humidity 20~85% RH or less (non-condensing)	



## Dimensions

CAD drawings can be downloaded from the website.

www.intelligentactuator.com

2D CAD

3D CAD

- \* The opening side of the slider is the home position.
- \* Shown below is a drawing for the Cleanroom Type. There is no air vacuum joint equipped on the Dust-proof Type.
- \* The actuator pigtail is not a robot cable.

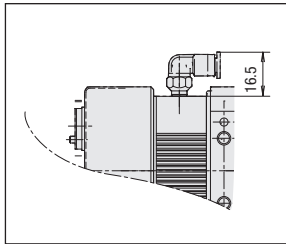

L-shaped vacuum joint specification

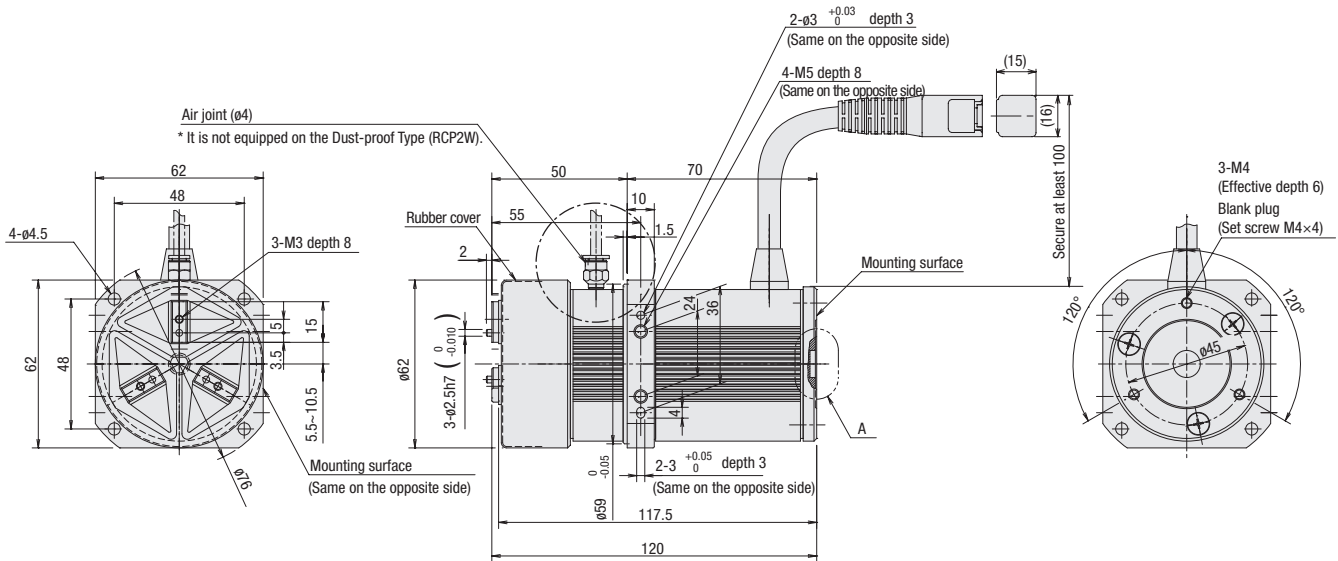
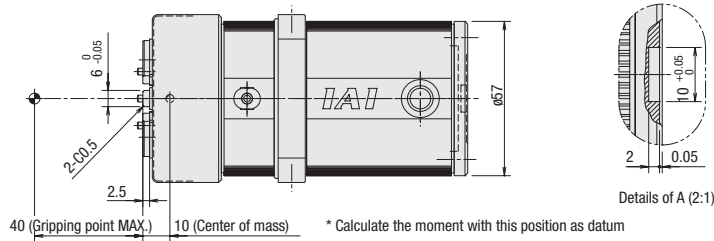

Weight (kg) 0.7

### ① Applicable Controllers

The RCP2 series actuators can operate with the controllers below. Select the controller according to your usage.

Name	External View	Model Number	Features	Max. Pos. Points	Input Voltage	Power Supply Capacity	Standard Price
Solenoid Valve Multi-axis Type (PIO Specification)		MSEP-①-③-④-①-2-0	Positioner type based on PIO control, allowing up to 8 axes to be connected	3 points	DC24V	See ROBO Cylinder General Catalog	-
Solenoid Valve Multi-axis Type (Network Specification)		MSEP-①-③-④-⑤-0-0	Field network ready positioner type, allowing up to 8 axes to be connected	256 points			-
Positioner Type High-output Specification		PCON-CA-28P①-①-2-0	Equipped with high-output driver Positioner type based on PIO control	512 points			-
Pulse Train Type High-output Specification		PCON-CA-28PWA1-PL□-2-0	Equipped with high-output driver Pulse train input type	-			-
Network Type High-output Specification		PCON-CA-28P⑤-⑤-0-0	Equipped with a high-output driver Supports 8 major field networks	768 points			-
Pulse Train Type (Differential Line Driver Specification)		PCON-PL-28PI-①-2-0	Pulse train input type with differential line driver support	-			-
Pulse Train Type (Open Collector Specification)		PCON-PO-28PI-①-2-0	Pulse train input type with open collector support	-			-
Serial Communication Type		PCON-SE-28PI-N-0-0	Dedicated serial communication	64 points			-
Program Control Type		PSEL-CS-1-28PI-①-2-0	Program operation is possible for up to 2 axes	1500 points	-		

\* This is for the single-axis PSEL.

\* ① indicates I/O type (N/P/M).

\* ③ indicates C/LC type. Up to 6 axes can be connected if LC is selected.

\* □ indicates N (NPN specification) or P (PNP specification) code.

\* ④ indicates number of axes (1-8).

\* ⑤ indicates field network specification code.

\* ⑤ indicates encoder type. Enter WAI for incremental specification and SA for simple absolute specification.

# RCP2CR-GR3SM

Cleanroom ROBO Cylinder, 3-finger Gripper, Slider Type, 80mm Width, Pulse Motor

# RCP2W-GR3SM

Dust-proof ROBO Cylinder, 3-finger Gripper, Slider Type, 80mm Width, Pulse Motor

<b>Model Specification Items</b> RCP2CR: Cleanroom RCP2W : Dust-proof	<b>RCP2CR</b> <b>RCP2W</b> Series	<b>GR3SM</b> Type	<b>I</b> Encoder	<b>42P</b> Motor	<b>30</b> Deceleration Ratio	<b>14</b> Opening/Closing Stroke	Applicable Controllers P1: PCON-PL/PO/SE PSEL P3: PCON-CA PMEC/PSEP MSEP	Cable Length N: None P: 1m S: 3m M: 5m X□□ : Custom R□□ : Robot cable	Options FB: Flange bracket SB: Shaft bracket VL: L-shaped vacuum joint specification
---	---	----------------------	---------------------	---------------------	---------------------------------	-------------------------------------	---	---	---

RoHS



\* The figure above shows the Cleanroom Type.  
There is no air vacuum joint equipped on the Dust-proof Type.

- POINT**  
Note on selection
- The maximum gripping force is the sum of gripping forces of all fingers at gripping point O (\*) and with overhang distance O. For the actual transportable work part weight, refer to the explanation to the right.  
\* The gripping point O should be the center of mass in the drawing.
  - Refer to "How to Select Gripper" at the end of the ROBO Cylinder General Catalog for how to select a gripper.
  - The rated acceleration while moving is 0.3G.

### Correlation Diagram of Gripping Force and Electric Current Limit

By pressing motion, the gripping (pushing) force can be adjusted freely within the range of electric current limits of 20% to 70%.

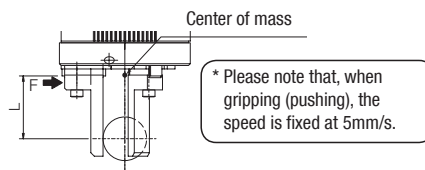

\* Please note that, when gripping (pushing), the speed is fixed at 5mm/s.

- \* Keep L within 80mm from the center of mass.
- \* The gripping force in the graph below assumes that L in the figure above is zero. Also note that the gripping force is a sum of gripping forces of all fingers.

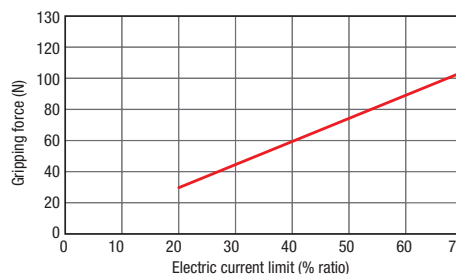

\* The gripping force graph above shows reference numbers. Please allow margins up to ±15%.

### Actuator Specifications

#### Max. Gripping Force and Stroke

Model Number	Deceleration Ratio	Max. Gripping Force (N)	Stroke (mm)
RCP2CR-GR3SM-I-42P-30-14-①-②-③	30	102 (34 per finger)	14 (7 per finger)
RCP2W-GR3SM-I-42P-30-14-①-②-③			

Legend: ① Applicable controllers ② Cable length ③ Options

#### Stroke and Max. Opening/Closing Speed / Suction Amount

Deceleration Ratio	Stroke	10 (mm)	Suction Amount (*)
30	50mm/s	10N $\pm$ /min	

\* For Cleanroom Type

#### Stroke

Stroke (mm)	Specification	Standard Price
14	Cleanroom	—
	Dust-proof	—

#### Cable Length

Type	Cable Code	Standard Price	
		Applicable Controller Code	
		P3	P1
Standard Type	P (1m)	—	—
	S (3m)	—	—
	M (5m)	—	—
Special Length	X06 (6m) ~ X10 (10m)	—	—
	X11 (11m) ~ X15 (15m)	—	—
	X16 (16m) ~ X20 (20m)	—	—
Robot Cable	R01 (1m) ~ R03 (3m)	—	Robot cable is standard for P1
	R04 (4m) ~ R05 (5m)	—	
	R06 (6m) ~ R10 (10m)	—	
	R11 (11m) ~ R15 (15m)	—	
	R16 (16m) ~ R20 (20m)	—	
		—	

#### Options

Name	Option Code	Standard Price
Flange Bracket	FB	—
Shaft Bracket	SB	—
L-shaped Vacuum Joint Specification (Cleanroom Only)	VL	—

#### <Option Code>

FB...Bracket only: RCP2-FB-GR3M

SB...Bracket only: RCP2-SB-GR3M

\* Check the size of the bracket in the option explanation at the end of the ROBO Cylinder General Catalog.

#### Actuator Specifications

Item	Description	
Series	Cleanroom	Dust-proof
Drive System	Worm gear+ Worm wheel gear	
Positioning Repeatability	±0.01mm	
Backlash	0.3mm or less per finger (constantly pressed out by a spring)	
Lost Motion	0.1mm or less per finger	
Allowable Static Load Moment	Ma: 6.3N·m Mb: 6.3N·m Mc: 5.7N·m	
Guide	Cross roller guide	
Cleanliness	Class 10 (0.1 $\mu$ m)	
IP Code	—	IP50
Weight	1.3kg	
Operating Environment	Temperature 0~40°C Humidity 20~85% RH or less (non-condensing)	



---

**IAI America, Inc.**

**Headquarters:** 2690 W. 237th Street, Torrance, CA 90505 (800) 736-1712

**Chicago Office:** 110 E. State Parkway, Schaumburg, IL 60173 (800) 944-0333

**Atlanta Office:** 1220 Kennestone Circle, Suite 108, Marietta, GA 30066 (888) 354-9470

**[www.intelligentactuator.com](http://www.intelligentactuator.com)**

The information contained in this product brochure may change without prior notice due to product improvements.

**IAI Industrieroboter GmbH**

Ober der Röth 4, D-65824 Schwalbach am Taunus, Germany

**IAI Robot (Thailand), CO., Ltd.**

825 PhairojKijja Tower 12th Floor, Bangna-Trad RD.,  
Bangna, Bangna, Bangkok 10260, Thailand

