

**Datasheet · 703413**

Subject to technical alteration  
Issue date: 21.03.2019 • A100

**» APPLICATION**

Differential pressure and volume flow transducer for monitoring differential pressure and volume flow of air and other non-flammable and non-aggressive gases. Three types with eight different measuring ranges are available for different applications. In addition to differential pressure all variants provide the calculated volume flow as second analog output signal. K-values for flow calculation (default 1500) can be parameterized via Thermokon USEapp. With the option board relay two-point controllers or a 2-stage 2-point controller for differential pressure or volume flow can be realized. The mounting base (included in delivery) allows mounting on a level surface or mounting on DIN rail TS35 (35x7,5 mm) according to EN 60715.

**» TYPES AVAILABLE****Differential pressure transducer – 2x 0..10 V | optional with Relay**

DPA250+ VV MultiRange <Relay> <AZ>  
DPA2500+ VV MultiRange <Relay> <AZ>  
DPA7000+ VV MultiRange <Relay> <AZ>

**Differential pressure transducer – 2x 4..20 mA**

DPA250+ AA MultiRange <AZ>  
DPA2500+ AA MultiRange <AZ>  
DPA7000+ AA MultiRange <AZ>

MultiRange: Measuring ranges adjustable at the transducer  
<AZ>: automatic zero-point calibration (optional)  
<Relay>: Relay (optional)

**» PRODUCT TESTING AND CERTIFICATION**

Declaration of conformity

The declaration of conformity of the products can be found on our website <https://www.thermokon.de/>.

## » SECURITY ADVICE – CAUTION



The installation and assembly of electrical equipment should only be performed by authorized personnel.

The product should only be used for the intended application. Unauthorised modifications are prohibited! The product must not be used in relation with any equipment that in case of a failure may threaten, directly or indirectly, human health or life or result in danger to human beings, animals or assets. Ensure all power is disconnected before installing. Do not connect to live/operating equipment.

Please comply with

- Local laws, health & safety regulations, technical standards and regulations
- Condition of the device at the time of installation, to ensure safe installation
- This data sheet and installation manual

## » NOTES ON DISPOSAL



As a component of a large-scale fixed installation, Thermokon products are intended to be used permanently as part of a building or a structure at a pre-defined and dedicated location, hence the Waste Electrical and Electronic Act (WEEE) is not applicable. However, most of the products may contain valuable materials that should be recycled and not disposed of as domestic waste. Please note the relevant regulations for local disposal.

## » TECHNICAL DATA

Measuring values	differential pressure, volume flow		
Medium	air or other non-flammable/non-aggressive gases		
Output voltage	0..10 V or 0..5 V, min. load 10 kΩ (live-zero configuration via Thermokon USEapp)		
Output Amp (type-dependent)	<b>AA</b> 2x 4..20 mA. max. load 500 Ω		
Output switch contact (type-dependent)	<b>Relay</b> 2 floating contacts for 24 V ~ or 24 V = / 3 A		
Power supply (type-dependent)	<b>VV   Relay</b> 15..35 V = or 19..29 V ~	<b>AA</b> 15..35 V =	
Power consumption	max. 2,3 W (24 V =)   max. 4,3 VA (24 V ~)		
Measuring range velocity	0... 750.000 m³/h (default), optionally configured via Thermokon USEapp		
Measuring range pressure *selectable at the device	<b>type 250</b> 0..+25   0..+50   0..+100   0..+250   -25..+25   -50..+50   - 100..+100   -150..+150 Pa	<b>type 2500</b> -100..+100   0..+100   0..+250   0..+500   0..+1000   0..+1500   0..+2000   0..+2500 Pa	<b>type 7000</b> 0..+1000   0..+1500   0..+2000   0..+2500   0..+3000   0..+4000   0..+5000   0..+7000 Pa
Accuracy pressure *deviation from calibration reference device (calibrator)	±1 Pa at range <250 Pa	±5 Pa at range <500 Pa, ±10 Pa at range >500 Pa	±10 Pa at range <2000 Pa, ±25 Pa at range >2000 Pa
Max. working overpressure	40 kPa		
Calibration	manually, automatic zero-point calibration (optional)		
Sensor	piezo measuring element		
Enclosure	enclosure USE-L, PC, pure white, with removable cable entry		
Protection	IP65 according to EN 60529		
Cable entry (type-dependent)	<b>VV   AA</b> Flextherm M16, for wire Ø=3..7 mm	<b>Relay</b> M25, for wire max. Ø=7 mm, seal insert for fourfold cable entry	
Connection electrical	removable plug-in terminal, max. 2,5 mm²		
Connection mechanical	pressure connection male Ø=5,0 mm / Ø=6,3 mm, connection tube: PVC, soft		
Ambient condition	-10..+50 °C, max. 85% rH short term condensation		
Mounting	screw mounted onto flat surface, prepared for mounting on DIN rail TS35 (35x7,5 mm) according to EN 60715		

» **MOUNTING ADVICES**

Before installing the device, please check the leak tightness of the pressure lines. A prerequisite for the operation is a proper installation of all electrical supply, control and sensing leads as well as the pressurized connection line.

- In order to connect the device, the process lines must be unpressurized
- Consider the suitability of the device for the medium to be measured
- Consider maximum pressures

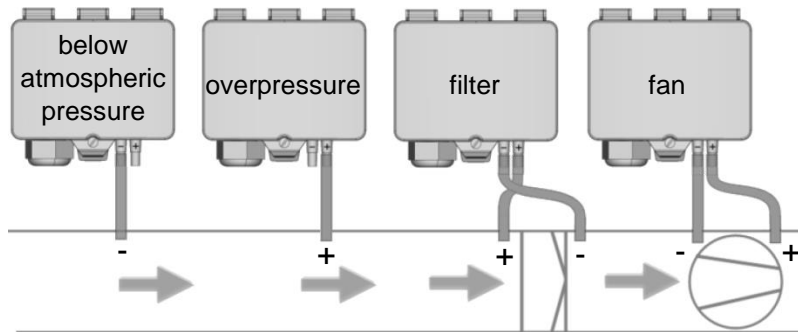

» **CONNECTION PLAN**

**DPA+ VV MultiRange**

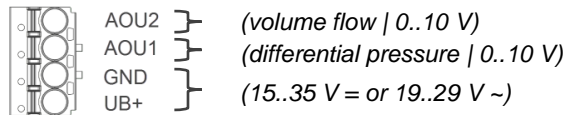
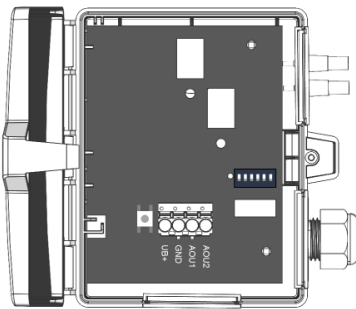

**DPA+ AA MultiRange**

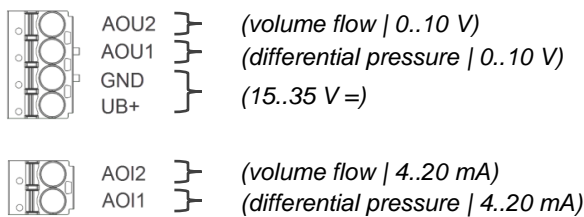
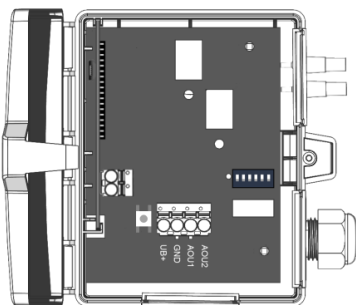

**DPA+ VV MultiRange Relay**

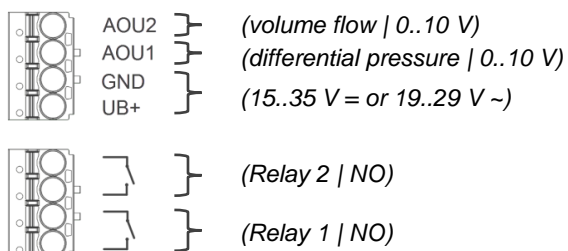
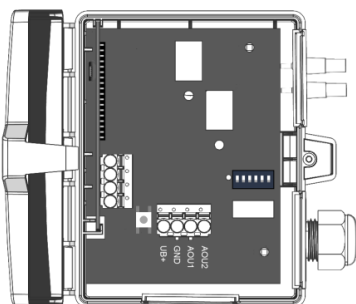

Measuring range adjustment – type 250 | 2500 | 7000

Measuring range adjustment								☐ = ON ☑ = OFF
ON	ON	ON	ON	ON	ON	ON	ON	
1 2 3	1 2 3	1 2 3	1 2 3	1 2 3	1 2 3	1 2 3	1 2 3	
0..+250	0..+100	0..+50	0..+25	-25..+25	-50..+50	-100..+100	-150..+150	Pa
0..+2500	0..+2000	0..+1500	0..+1000	0..+500	0..+250	0..+100	-100..+100	Pa
0..+7000	0..+5000	0..+4000	0..+3000	0..+2500	0..+2000	0..+1500	0..+1000	Pa
0..+1	0..+0.4	0..+0.2	0..+0.1	-0.1..+0.1	-0.2..+0.2	-0.4..+0.4	-0.6..+0.6	inchWC
0..+10	0..+8	0..+6	0..+4	0..+2	0..+1	0..+0.4	-0.4..+0.4	inchWC
0..+28	0..+20	0..+16	0..+12	0..+10	0..+8	0..+6	0..+4	inchWC

default

Response time

Output voltage

Unit

Response time		Output voltage		Unit	
ON	ON	ON	ON	ON	ON
4	4	5	5	6	6
0,8 sec	4,0 sec	0..10 V	0..5 V	Pa	inchWC
default		default		default	

Flow calculation: (default parameters)

$$q = k * \sqrt{2 * \frac{\Delta p}{\rho}}$$

with k=1500, fan manufacturer Rosenberg, Comefri, Nicotra Gebhardt, default measuring range 0..750.000 m³/h.

Further calculation formulas, fan manufacturers and k-values can be selected via the USEapp.

Rosenberg · Comefri · Gebhardt · Nicotra	Ziehl-Abegg · EBM-Papst	Fläkt Woods
$q = k * \sqrt{2 * \frac{\Delta p}{\rho}}$	$q = k * \sqrt{\Delta p}$	$q = \frac{1}{k} * \sqrt{\Delta p}$

» **AUTOMATIC ZERO-POINT CORRECTION - (OPTIONAL)**



Transmitters equipped with the auto-zero correction are maintenance free.

The auto-zero correction electronically adjusts the transmitter zero every 10 minutes. The function eliminates all output signal drift due to thermal, electronic or mechanical effects. The auto-zero correction takes approx. 4 seconds after which the device returns to its normal measuring mode. During the 4 second correction period, the output and display values will freeze to the latest measured value.

» **MANUAL ZERO-POINT CORRECTION (FOR DEVICES WITHOUT AUTO-ZERO FUNCTION)**

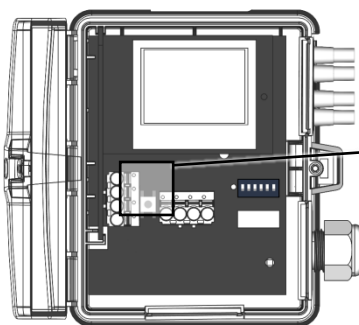

In normal operation zero point correction should be executed every 12 months.

**Attention! For executing zero point correction the power supply must be connected one hour before.**

- Release both connection tubes from the pressure terminals + and -
- Press the button until the LED lights permanently
- Wait until the LED flashes again and reinstall the connection tubes to the pressure ports (note + and -)

» **CONFIGURATION**



The Thermokon bluetooth dongle with micro-USB is required for communication between USEapp and USE-M / USE L (Item No.: 668262). Commercial bluetooth dongles are not compatible.



Application-specific reconfiguration of the devices can be carried out using the Thermokon USEapp. The configuration is carried out in the voltage-supplied state.



The configuration-app and the app description can be found in the Google Play Store or in the Apple App Store.

» **DIMENSIONS (MM)**

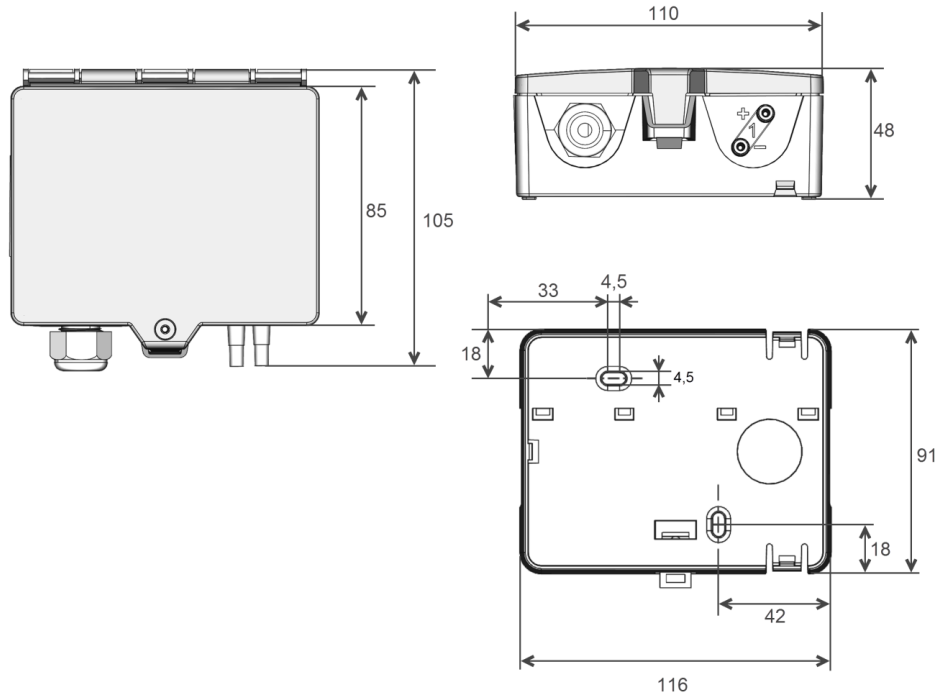

» **ACCESSORIES (INCLUDED IN DELIVERY)**

Mounting base enclosure USE-L  
2 m PVC connection tube  
KKS40 kit

- 2 plastic duct flanges
- 4 mounting screws 4x20

Item No. 668361  
Item No. 484268  
Item No. 430135

Mounting kit universal

- Cover screw + screw cover • 2 Rawlplugs • 2 Screws (countersunk head) • 2 Screws (rounded head)

Item No. 698511

» **ACCESSORIES (OPTIONAL)**

Bluetooth dongle USE for USEapp  
Cable entry M25 USE white, sealing insert 4x Ø=7 mm (4 pcs)  
T-hose connector for pressure hoses Ø=4 mm (10 pcs)  
Adapter 90° angle for pressure hoses Ø=4 mm  
Metal duct connectors 40 mm  
Metal duct connectors 100 mm

Item No. 668262  
Item No. 641364  
Item No. 668323  
Item No. 668330  
Item No. 265138  
Item No. 302531

**M16 Sealing inserts cable entry (packaging unit 10 pcs.)**

for wire with Ø	8 mm
Item No	641340

**M20 Sealing inserts cable entry (packaging unit 10 pcs.)**

for wire with Ø	2x6 mm	2x7 mm	6 mm	8 mm
Item No	641319	641333	641074	641081