

Datasheet

Subject to technical alteration
Issue date: 26.09.2018 • A004



Application

The fan coil room thermostat has been designed for individual control of temperature in commercial, industrial and residential buildings. It is tailored for 4-pipe fan coil with two-wire electric valves. With its flush mounted modern design the device combines digital technology with a large LCD display and additional buttons, which enables the single room controller to be used intuitively.

Security Advice – Caution



The installation and assembly of electrical equipment should only be performed by authorized personnel.

The product should only be used for the intended application. Unauthorised modifications are prohibited! The product must not be used in relation with any equipment that in case of a failure may threaten, directly or indirectly, human health or life or result in danger to human beings, animals or assets. Ensure all power is disconnected before installing. Do not connect to live/operating equipment.



CAUTION! Risk of electric shock due to live components within the enclosure, especially devices with mains voltage supply (usually between 90..265 V).

Please comply with

- Local laws, health & safety regulations, technical standards and regulations
- Condition of the device at the time of installation, to ensure safe installation
- This data sheet and installation manual

Notes on Disposal



As a component of a large-scale fixed installation, Thermokon products are intended to be used permanently as part of a building or a structure at a pre-defined and dedicated location, hence the Waste Electrical and Electronic Act (WEEE) is not applicable. However, most of the products may contain valuable materials that should be recycled and not disposed of as domestic waste. Please note the relevant regulations for local disposal.

Remarks to Room Sensors

Location and Accuracy of Room Sensors

The room sensor should be mounted in a suitable location for measuring accurate room temperature. The accuracy of the temperature measurement also depends directly on the temperature dynamics of the wall. It is important, that the back plate is completely flush to the wall so that there is sufficient circulation of air through the vents in the cover, otherwise, deviations in temperature measurement will occur due to uncontrolled air circulation. The temperature sensor should not be covered by furniture or other objects. Mounting next to doors (due to draught) or windows (due to colder outside wall) should be avoided.

Surface and Flush Mounting

The measuring result is influenced by the thermal characteristics of the wall. A solid concrete wall responds to thermal fluctuations within a room in a much slower than a light-weight structure wall. Room temperature sensors installed in flush-mounted boxes have a longer response time to thermal variations. In extreme cases they detect the radiant heat of the wall even if the air temperature in the room is lower for example. The quicker the dynamics of the wall (temperature acceptance of the wall) or the longer the selected inquiry interval of the temperature sensor is the smaller the deviations limited in time are.

Technical Data

Measuring values	temperature	
Output voltage	0..10 V = (for 6-way valves)	
Output switch contact	3x Fancoil normally open contacts, 250 V load max. 5 A	
Power supply	24 V = 24 V ~	
Power consumption	3 W (24 V =)	
Measuring range temp.	+1..+50 °C	
Accuracy temperature	±1 °C (typ. at 21 °C, offset adjusted ¹)	
Inputs	terminal 9 – ESI DP input digital for floating contact, window contact, dew point sensor	terminal 10 - OCC input digital for floating contact, occupancy sensor
Control functions	set point adjustment +1..+50 °C, (default +16..+30 °C)	
Display	LCD 64x41 mm, white background lighting	
Enclosure	ABS, pure white	
Protection	IP20 according to EN 60529	
Cable entry	rear entry	
Connection electrical	terminal block max. 1,5 mm ²	
Ambient condition	-10..+50 °C, max. 95% rH non-condensing	
Weight	160 g	
Mounting	flush mounted with standard EU box (Ø=60 mm)	

¹ This Accuracy can be set using the offset to ensure that precise measurements can be carried out even under very different operating conditions (structural conditions).



Declaration of conformity

The declaration of conformity of the products can be found on our website <https://www.thermokon.de/>.

Connection Plan

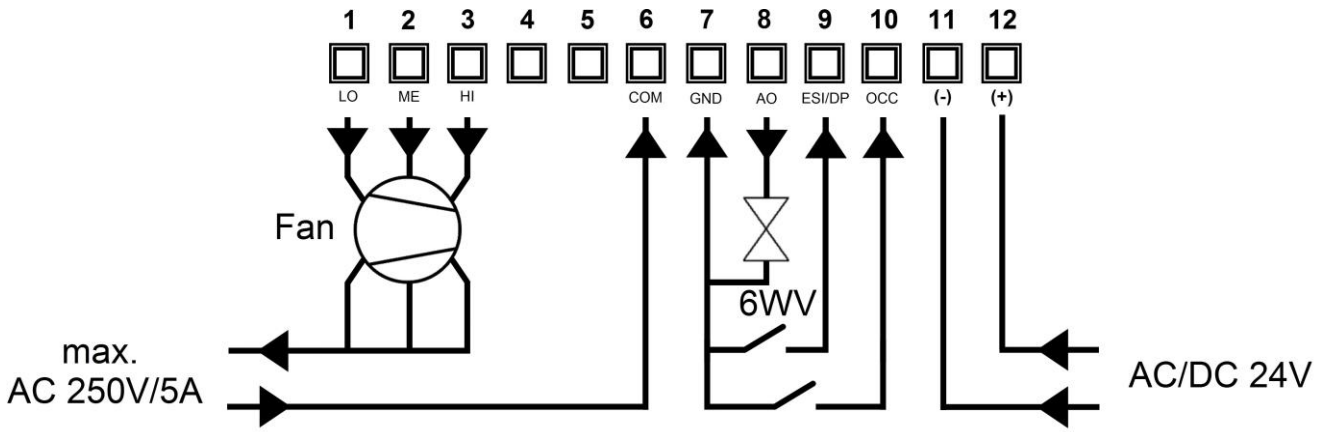

Display Panel

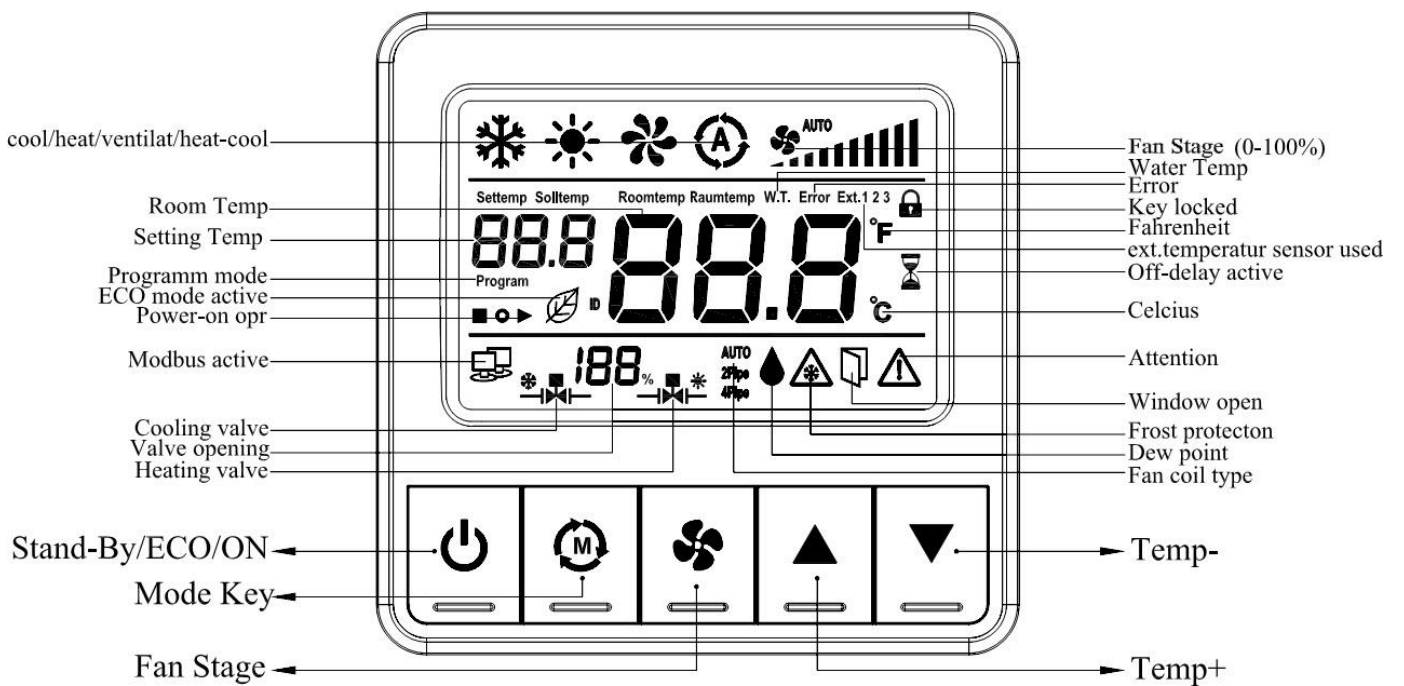

Function Description

During device start-up the version and type number are displayed on the start screen for a short time.

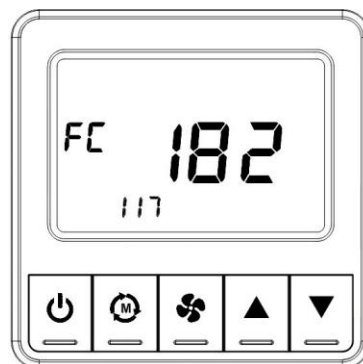

Valve Characteristic Curve

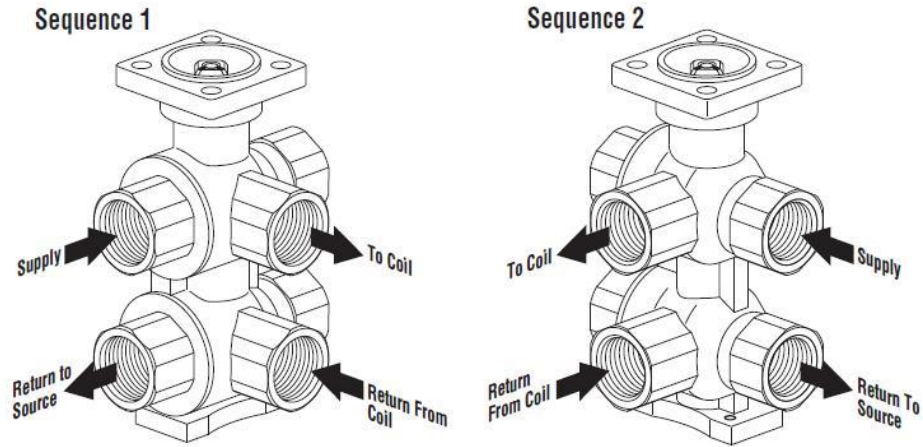

Sequence 1 - 2.0..4.7 V (Cooling) → 7.3..10.0 V (Heating)

Sequence 2 - 2.0..4.7 V (Heating) → 7.3..10.0 V (Cooling)

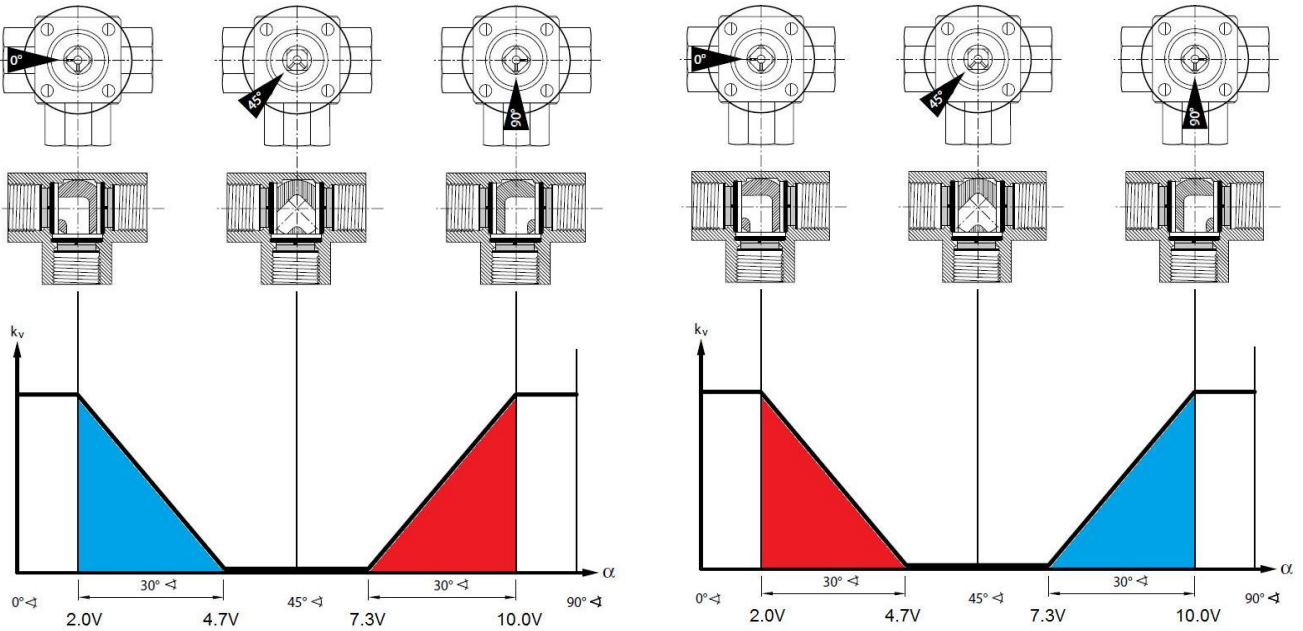

Mode selective

Press the “”key, to adjust the mode cyclically

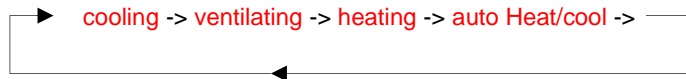

which is indicated by the according symbols:



Fan speed selective

Switches the fan speed cyclically (Low > Med > Hi > Auto > Low...).

°F/°C selective

With the device switched ON, press “▲” and “▼” key at the same time for more than 3s, to change from °F to °C or vice versa. Temp display range is 32 °F..99 °F, respectively 0 °C..50 °C (factory default is °C).

Temperature offset correction

The internal sensor will be affected by the Thermostat’s self-heating. As a consequence it would display a higher room temperature than the average of indoor temperature (real value). Item 1 of the parameter table does contain the correction of temperature offset (resolution 0,1 °C).

Set the Temperature set point range

Press “▲” or “▼” key to adjust the temperature set point range. Factory default (°C) is 16 °C..30 °C, When °F has been selected Temp range is 60 °F..86 °F (Item 4 and item 5 of the parameter table).

Heating / Cooling mode logic

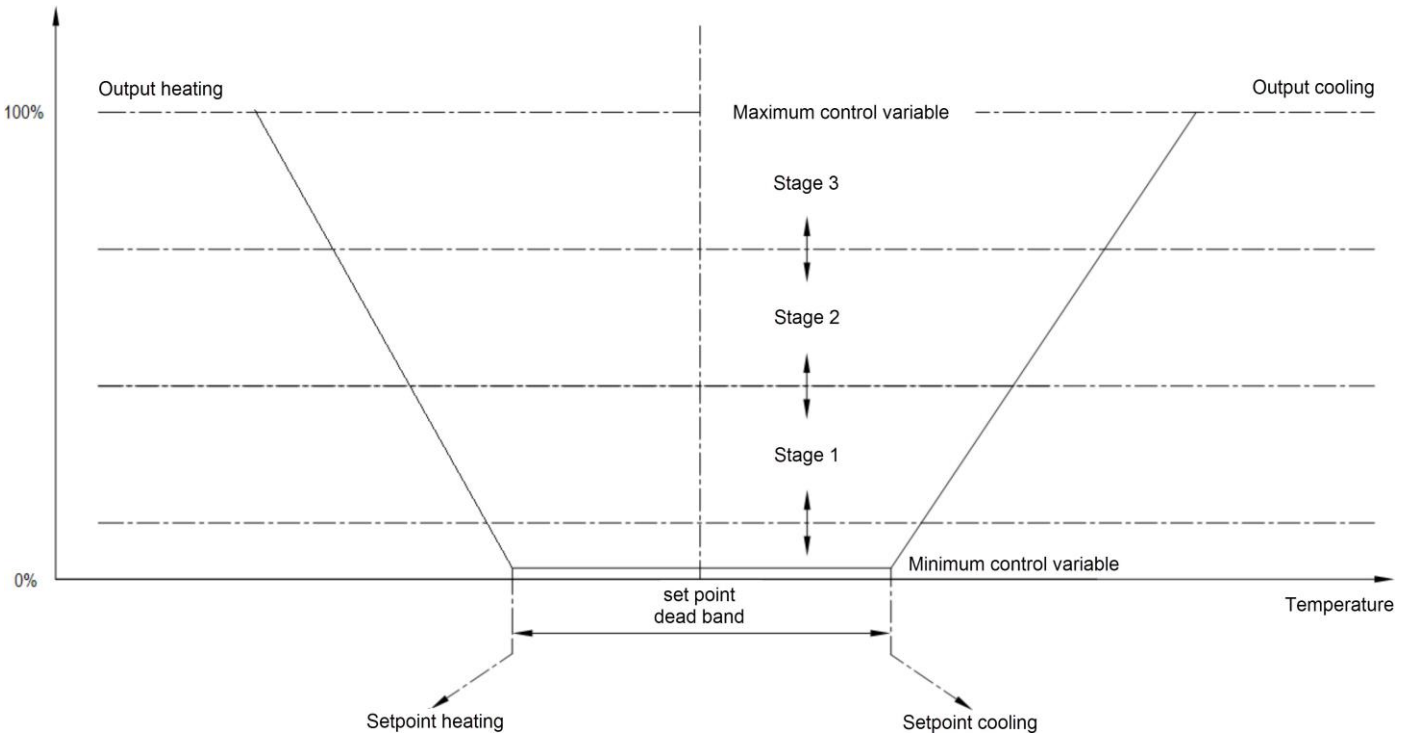

Minimum and maximum control variable are set in the parameter table (item 8 & 9).

PI loop’s output will be converted to an analogue voltage depending on valve type:

Valve Type	Characteristic
0: Belimo 6 way	Sequence 1 Cooling: (100%...0%) = 2,0...4,7V Heating: (0%...100%) = 7,3V...10.0V
1: Sauter 6 way with Ø15mm	similar to Sequence 1 Cooling: (100%...0%) = 0,6...3,9V Heating: (0%...100%) = 6,1V...9.2V
2: Sauter 6 way with Ø20mm	similar to Sequence 1 Cooling: (100%...0%) = 1,3...4,8V Heating: (0%...100%) = 5,3..8,5V
3: Belimo 6 , counter direction	way counter direction = Sequence 2 Heating: (100%...0%) = 2,0...4,7V Cooling: (0%...100%) = 7,3V...10.0V
4: Sauter 6 way with Ø15mm, counter direction	similar to Sequence 2 Heating: (100%...0%) = 0,6...3,9V Cooling: (0%...100%) = 6,1V...9.2V
5: Sauter 6 way with Ø20mm, counter direction	similar to Sequence 2 Heating: (100%...0%) = 1,3...4,8V Cooling: (0%...100%) = 5,3..8,5V

Fan Mode Auto/ON Selection (item 7 in parameter table):

When Fan Mode is set to ON, the Fan will follow the valve, when the valve is switched off the fan will stay at LOW even if control variable is below 5%.

When Fan Mode is set to AUTO: Fan will follow the valve according to the figure below. When the valve is switched off the fan will do the same after a delay of 120s to make use of the energy stored in the heat exchanger when the valve is closing. Exception will be if an open window is detected. (See ESI input description)

Fan speed according to manual setting: Low, Med, Hi. To turn off the fan manually the thermostat shall be turned off.

When the thermostat is turned OFF or to Ventilation Mode the valve output must maintain the valve at centre position to close the valve fully. The voltage will depend on the type of valve selected.

When fan speed AUTO is selected the fan speed will be according to the output of the control variable (PI Loop output):

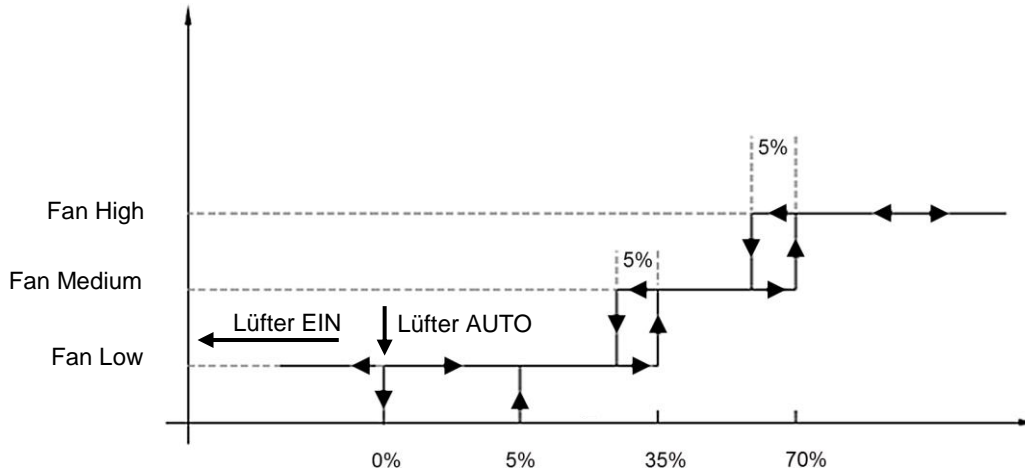

Ventilating mode running logic

In ventilating mode, the valve is closed, the fan speed is according the manual selection: Low > Med > Hi. In case Fan-Auto is selected in Ventilating mode, it will follow table above (2-point controller is active with 1 K Hysteresis).

Fan control “Auto” in ventilating mode

Condition for 2-point Control and ventilation mode	Fan status
$\Delta T \leq 1\text{ }^{\circ}\text{C}$	
$1\text{ }^{\circ}\text{C} < \Delta T < 3\text{ }^{\circ}\text{C}$	
$\Delta T \geq 3\text{ }^{\circ}\text{C}$	

Key lock selection

Please see item 2 in parameter table. If a key is pressed that is locked, the lock symbol will appear for 2s and blink 2x but no further action is taken.

Power failure – Restart selection

Please see item 3 in parameter table to set.

On the LCD, there are three symbols that define how the thermostat will restart after a power failure:

Keep thermostat switched OFF

Switch thermostat to last state before power failure (Record and Memorize)

Turn the thermostat ON

LCD backlight selection

Please see item 6 in parameter table to set.

parameter table

To enter the parameter table, switch off the thermostat and while switched off press the "Mode Key" for more than 3s. Once the Display comes on, it will prompt for the password set by parameter 18. The password can be entered digit by digit. Each digit can be increased / decreased using the "▲" or "▼" keys. With the "Mode Key" the next digit will be selected.

Each parameter can be increased / decreased using the "▲" or "▼" keys. With the "Mode Key" the display will move on to the next parameter. Once the end of the table is reached the parameter setting will be exited to normal operation.



No.	Name of parameter	Parameter definition	Factory default
1	Temp offset	range : -100..+100, scaling factor 10 (-10.0 °C..+10.0 °C)	0
2	Key-lock	0x00 = unlocked 0x01 = lock "on/off" 0x02 = lock "mode" 0x08 = lock "fan speed" 0x10 = lock "temp setting" 0x1F = lock all keystrokes Once a locked key is pressed the LOCK symbol shall be displayed for 2 s and blink twice.	0
3	State after Power failure	0 - keep power off 1 - Memo status before power failure 2 - switch on with power on	0
4	Temp upper limit	range: 1 °C..+50 °C / 34 °F..+99 °F	30 °C / 86 °F
5	Temp lower limit	range: 1 °C..+50 °C / 34 °F..+99 °F	16 °F / 60 °F
6	LCD backlight	0 - backlight OFF, 1 - backlight ON	1
7	Fan Mode	0 - fan is ON permanently, 1 - fan stops when valve closes	0
8	Minimal Control Variable	0= 0.0V... 40 = 4.0V	0
9	Maximal Control Variable	60= 6.0V... 100 = 10.0V	100
10	OCC Input	0 = OCC (NC=Open when Occupied) 1 = OCC (NO=Closed when Occupied) Default setting (0) will indicate OCCupied in case no sensor is connected	1
11	ESI /DP input	0 = window contact (NC=Open when window Open) 1 = window contact (NO=Closed when window Open) 2 = dew point (NC=Open when dew point is reached/exceeded) 3 = dew point (NO=Closed when dew point is reached/exceeded)	1
12	Xp	0=0... 100 (0...10.0K)	4
13	Tn	0=0... 100	21
14	"Eco Mode" Heating setpoint	Range : 1 °C..+50 °C / 34 °F..+99 °F	18 °C / 64 °F
15	"Eco Mode" Cooling setpoint	Range : 1 °C..+50 °C / 34 °F..+99 °F	25 °C / 77 °F
16	Valve selection	0: Belimo 6 way 1: Sauter 6 way with Ø15mm 2: Sauter 6 way with Ø20mm 3: Belimo 6 way, counter direction 4: Sauter 6 way with Ø15mm, counter direction 5: Sauter 6 way with Ø20mm, counter direction	0
17	Language	0 = German 1 = English	0
18	Password	Password to change parameters	987

OCC Input function

If the input is configured for an Occupancy sensor (Item 10 of parameter table to set OCC sensor). If the sensor indicates "UnOccupied" the current setpoint will be replaced by the Eco Mode Setpoint Temp (parameter 15) The display will show the leaf symbol  to indicate the ECO mode. Once the room occupancy is detected again the previously used Setpoint will be restored and the leaf symbol will not be showing any more.

Window contact (ESI) function

If the input is configured as window contact (Item 11 in parameter table to set window contact), the "Window open" Symbol will be displayed the thermostat will check every 3 seconds the input whether active. The cooling valve will be closed as long as the input will be active. The rest of the thermostat will work as usual, the user may change the setpoint or the fan stage, but the valve

outputs will remain in valve closed position. Depending on parameter 11 the "Window open"  or the Dew Point symbol  will be flashing. When the input will not be active, the thermostat's outputs return to normal operation and operates the outputs normally.

Memo while the power failure

The status will be kept in EEPROM, while the power failure, so no data will be lost.

Sensor failure alarm

In case the room NTC temp sensor is open or short, thermostat switches fan to medium and the valve to 50% (5V output, 50% duty cycle for PWM and ON/OFF). The display will show (blinking) error code: "E1" Thermostat will allow to control fan manually as well as the valve output using the "▲" or "▼" keys. Every operation of the "▲" or "▼" keys will decrement / increment the output voltage by 1V = 10% AND the PWM by 10%. The percentage is shown in the display.

Installation

For Installing or repairing, please make sure the power is disconnected.

Insert the screw driver in the plastic tooth of thermostat. Clockwise rotation of the screwdriver will separate front cover from base plate. Please follow the wiring diagram to connect the wires. Fix the thermostat base plate to the wall through the four screw holes with distance between axes of 60 mm. Fasten base plate and front cover. Do not press the panel in order to protect LCD.

Dimensions (mm)

