

Think Automation and beyond...



LUMIFA™

LF1D/LF2D Series LED Illumination Units

Brightest in its class, great power savings!

The unique lens design, optimized power circuit, and heat dissipation structure achieves high brightness both at the center and periphery.



IDEC CORPORATION

(100611)

Illumination for industrial purposes are required to guarantee resistance against harsh environments subject to water, oil, and metal chips, while providing brightness specified by standards. IDEC's LUMIFA LED Illumination units ensure long service life, energy savings, low heat generation, cleanliness and high resistance against shock. The LUMIFA series achieves high environment resistance and brightness required to ensure safety in working environments. The slim profile design of the highly bright LED modules and efficient heat dissipation technology is ideal for installation in various machines and equipment.

LF1D/LF2D Series LED Illumination Units

Brightest in its class, excellent power savings. The optimal optical design achieves high brightness both at both the center and edges. IP67f degree of protection.



Robust and Resistant

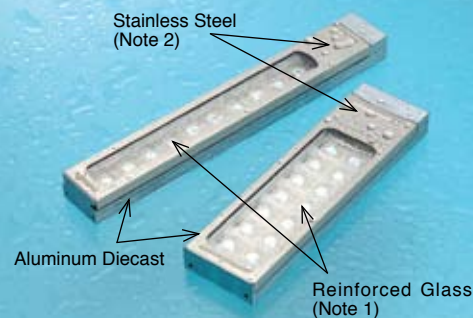

- Degree of protection IP67f (reinforced glass illumination surface). Waterproof, dust-proof, and oil-proof. Can be used in environments subject to water, dust, and oil.
- Construction of diecast aluminum (base), stainless steel (front), and reinforced glass. Resistant against flying chips.

Note 1: Polycarbonate available for applications such as food machines.

Note 2: LF2D is in aluminum diecast.

High Brightness, Energy Savings, and Compact Size!

• Brightest in its class

The optimal optical design achieves high brightness. Achieves illuminance specified by EN1837: 1999, 4.2. (1100 lx at 1m directly below)

• Heat Dissipation

Heat is dissipated by the aluminum housing efficiently.



• Efficient power circuit

Highly efficient, low-heat power circuit.

• Glare prevention

Diffused type available to prevent glaring light and reflection. (EN1837: 1999, 4.3.)



Optimal Light Distribution

• Distribution Characteristics (reference value at 1.0m)

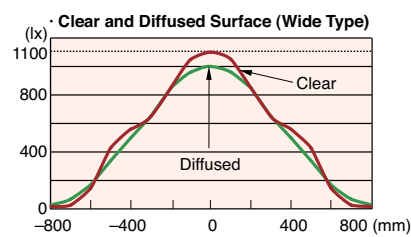
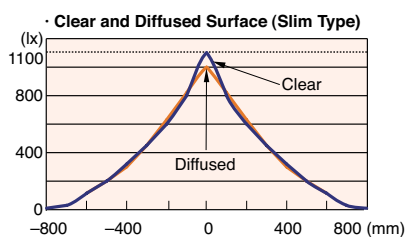
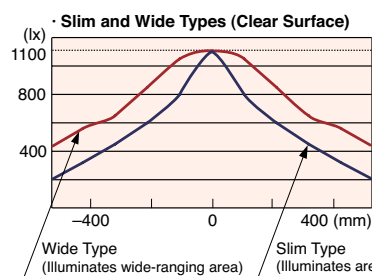

LF series LED Illumination Units

Low heat:	LED illumination generate very little heat, unlike incandescent and halogen lamps.
Long service life:	Maintenance-free operation for 50,000 hours.
Vibration/shock resistance:	Highly resistant.
Energy saving:	Less power consumption when compared with fluorescent lamps, contributing to CO ₂ reduction.
RoHS compliant:	Environmentally friendly compared with mercury-laden fluorescent lamps.

Easy Maintenance

• Spring-clamp terminal blocks

Removable direct plug-in terminal block and spring clamp connections ensure a high quality connection, making it easy to install or replace the LED illumination unit.

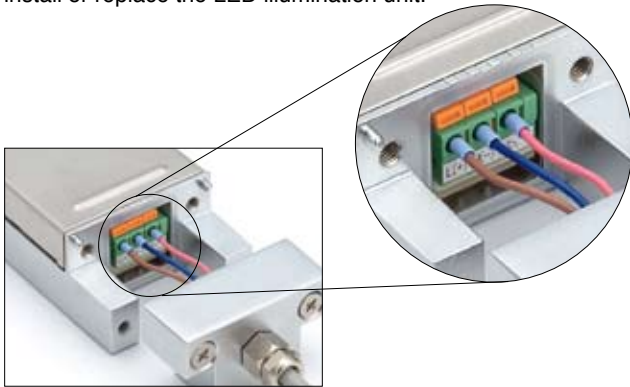

<Connection Example>

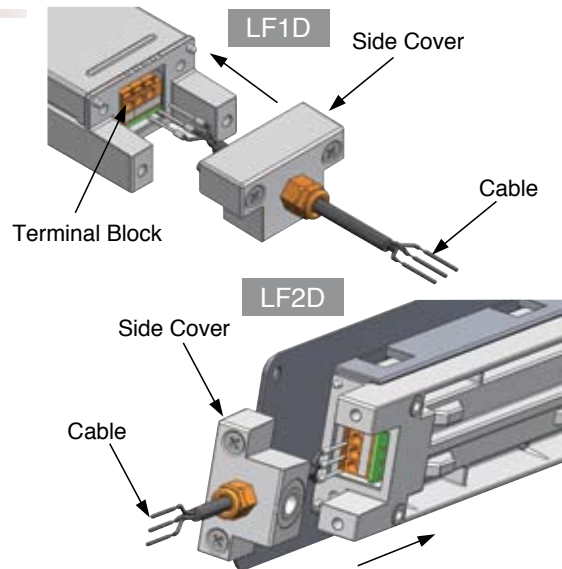

Accessories

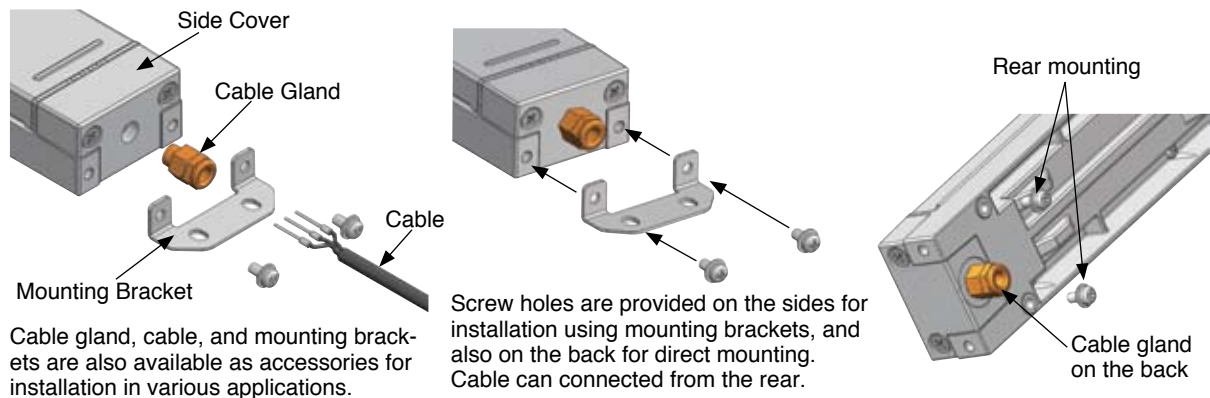

Applications

LF1D

An application in a drilling machine.



LF2D—slim flange design.

Only 5 mm extension from the mounting panel.

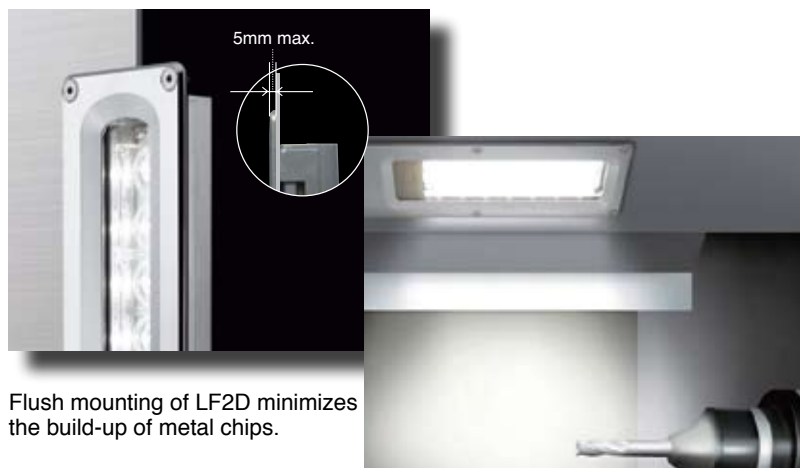

LUMIFA™ LF1D/LF2D LED Illumination Units

Brightest in its class, excellent power savings. Optimal optical design achieves high brightness at both the center and periphery. IP67f degree of protection.

- LED provides energy-savings, long-life, space-saving and no-maintenance advantages.
- Illumination surface variety—reinforced glass or polycarbonate, both in clear or diffused type.
- IP67f degree of protection (polycarbonate: IP67)
- Robust housing of aluminum diecast and stainless steel.
- Thin and slim profiles allow installation in space-limited areas.
- Even low profile is available with the sleek design of LF2D. Resistant to dust build up on the surface.

Application examples

Machine tools, food processing equipment, automatic manufacturing machines, printing machines, production system, test equipment, refrigeration and freezers.



Types

• LF1D (Illumination color: white)

Type			Slim Type (LF1D-E)		Wide Type (LF1D-F)	
Appearance						
LED Arrangement			10 LEDs × 1 row		7 LEDs × 2 rows	
Optional Accessories			Illumination Surface		Illumination Surface	
Cable Gland LF9Z-A11	Cable LF9Z-C05	Mounting Bracket LF9Z-B11, -B12	Clear Reinforced Glass	Clear Polycarbonate	Clear Reinforced Glass	Clear Polycarbonate
Without (Cable gland hole on the side of LF1D)	—	—	LF1D-E2F-2W	LF1D-E3G-2W	LF1D-F2F-2W	LF1D-F3G-2W
		With	LF1D-E2F-2W-101	LF1D-E3G-2W-101	LF1D-F2F-2W-101	LF1D-F3G-2W-101
Without (Cable gland hole on the back of LF1D)	—	—	LF1D-E2F-2W-200	LF1D-E3G-2W-200	LF1D-F2F-2W-200	LF1D-F3G-2W-200
		With	LF1D-E2F-2W-201	LF1D-E3G-2W-201	LF1D-F2F-2W-201	LF1D-F3G-2W-201
With (Side)	—	—	LF1D-E2F-2W-300	LF1D-E3G-2W-300	LF1D-F2F-2W-300	LF1D-F3G-2W-300
		With	LF1D-E2F-2W-301	LF1D-E3G-2W-301	LF1D-F2F-2W-301	LF1D-F3G-2W-301
	With	—	LF1D-E2F-2W-350	LF1D-E3G-2W-350	LF1D-F2F-2W-350	LF1D-F3G-2W-350
		With	LF1D-E2F-2W-A	LF1D-E3G-2W-A	LF1D-F2F-2W-A	LF1D-F3G-2W-A
With (Back)	—	—	LF1D-E2F-2W-400	LF1D-E3G-2W-400	LF1D-F2F-2W-400	LF1D-F3G-2W-400
		With	LF1D-E2F-2W-401	LF1D-E3G-2W-401	LF1D-F2F-2W-401	LF1D-F3G-2W-401
	With	—	LF1D-E2F-2W-450	LF1D-E3G-2W-450	LF1D-F2F-2W-450	LF1D-F3G-2W-450
		With	LF1D-E2F-2W-451	LF1D-E3G-2W-451	LF1D-F2F-2W-451	LF1D-F3G-2W-451

• Contact IDEC for cable gland hole other than the standard M8 size.

• LF2D (Illumination color: white)

Type			Slim Type (LF2D-E)		Wide Type (LF2D-F)	
Appearance						
LED Arrangement			10 LEDs × 1 row		7 LEDs × 2 rows	
Optional Accessories			Illumination Surface		Illumination Surface	
Cable Gland LF9Z-A11	Cable LF9Z-C05		Clear Reinforced Glass	Clear Polycarbonate	Clear Reinforced Glass	Clear Polycarbonate
Without (cable gland hole on the side of LF2D)	—		LF2D-E2F-2W	LF2D-E3G-2W	LF2D-F2F-2W	LF2D-F3G-2W
			LF2D-E2F-2W-200	LF2D-E3G-2W-200	LF2D-F2F-2W-200	LF2D-F3G-2W-200
With (Side)	—		LF2D-E2F-2W-300	LF2D-E3G-2W-300	LF2D-F2F-2W-300	LF2D-F3G-2W-300
		With	LF2D-E2F-2W-A	LF2D-E3G-2W-A	LF2D-F2F-2W-A	LF2D-F3G-2W-A
With (Back)	—		LF2D-E2F-2W-400	LF2D-E3G-2W-400	LF2D-F2F-2W-400	LF2D-F3G-2W-400
		With	LF2D-E2F-2W-450	LF2D-E3G-2W-450	LF2D-F2F-2W-450	LF2D-F3G-2W-450

• Contact IDEC for cable gland hole other than the standard M8 size.

Accessories

Type	Material	Type No.	Remarks	Package Quantity
Cable Gland	Brass	LF9Z-A11	M8, applicable wire size: ø3.5 to 5.5 mm	1
Mounting Bracket	Stainless Steel	For LF1D-E (slim type)	LF9Z-B11	With mounting screws
		For LF1D-F (wide type)	LF9Z-B12	With mounting screws
Cable	PVC	LF9Z-C05	5m	1

• Contact IDEC for angle adjustable mounting bracket (LF1D).

LUMIFA™ LF1D/LF2D LED Illumination Units

Type No. Development

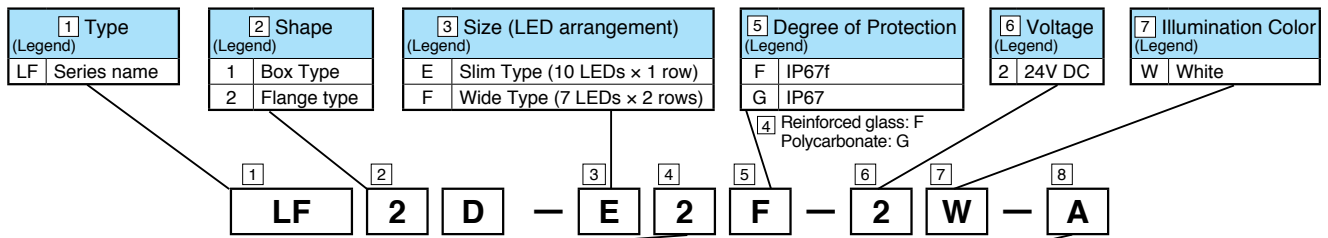

4 Illumination Surface (Legend)	2 Clear	Reinforced glass
	3 Clear	Polycarbonate
	5 Diffused	Polycarbonate
	9 Diffused	Reinforced glass

8 Cable Gland (Legend) (LF9Z-A11)	Blank Without accessories. Cable gland hole on the side.	8 Cable (Legend) (LF9Z-C05)	8 Mounting Bracket (Legend) (LF9Z-B11, LF9Z-B12)
A	With cable gland (standard). With cable. With mounting bracket (LF1D only)		
1	Without cable gland. Cable gland hole on the side.	0	Without
2	Without cable gland. Cable gland hole in the back.	0	Without
3	With cable gland (standard) on the side.	0	Without
4	With cable gland (standard) in the back.	5	Yes

- LF1D/LF2D: "100" and "351" are not available.
- LF2D: "350" and "351" (with mounting bracket) are not available.

Specifications

• General Specifications

Series	LF1D		LF2D	
	Slim	Wide	Slim	Wide
Type	Slim	Wide	Slim	Wide
Rated Voltage	24V DC			
Voltage Range	21.6 to 26.4V DC			
Rated Power (typ.) (at rated voltage)	9W	12.5W	9W	12.5W
Insulation Resistance	1MΩ minimum (500V DC megger)			
Dielectric Strength	1000V AC 50/60Hz, 1 minute			
Vibration Resistance (damage limits)	Frequency 5 to 55 Hz, amplitude 0.5 mm			
Shock Resistance (damage limits)	1000 m/s ²			
Operating Temperature	-30 to +55°C (no freezing)			
Operating Humidity	45 to 85% RH (no condensation)			
Storage Temperature	-35 to +70°C (no freezing)			
Operating Atmosphere	No corrosive gas			
Life (Note 1)	50,000 hours (The illumination duration in which the brightness maintains a minimum of 70% of the initial value at 25°C.)			
Degree of Protection (Note 2)	IP67f (reinforced glass), IP67 (polycarbonate)			
Material (Note 3)	Housing: Diecast aluminum Front cover: Stainless steel Illumination surface: Reinforced glass or polycarbonate		Housing and flange: Diecast aluminum Illumination surface: Reinforced glass or polycarbonate	
Weight (approx.)	LF1D-E**2W*: 750g LF1D-E**2W-A*: 950g	LF1D-F**2W*: 800g LF1D-F**2W-A*: 1000g	LF2D-E**2W*: 850g LF2D-E**2W-A*: 1000g	LF2D-F**2W*: 900g LF2D-F**2W-A*: 1050g

Note 1: LED life depends on the operating environment.

Note 2: Waterproof or oil-proof characteristics specified by IEC 60529 and JEM1030.

For illumination units without accessories, use a cable gland and cable that satisfy IP67f or IP67 degree of protection.

Note 3: The reinforced glass and polycarbonate illumination surfaces have the same appearance, but have different degrees of protection (IP67f or IP67).

• LED Optical Specifications

Series	LF1D				LF2D			
	Slim		Wide		Slim		Wide	
Type	Slim	Wide	Slim	Wide	Slim	Wide	Slim	Wide
Illumination Surface	Clear	Diffused	Clear	Diffused	Clear	Diffused	Clear	Diffused
Illumination Color	White							
Color Temperature (typ.)	5700K							
Total Luminous Flux (typ.)	600 lm		840 lm		600 lm		840 lm	
Reference Illuminance (typ.) at 1.0m directly below	1100 lx	1000 lx	1100 lx	1000 lx	1100 lx	1000 lx	1100 lx	1000 lx

• LED modules and illumination units may vary in illumination color and illuminance.

Illuminance Distribution (LF1D/LF2D) at 1.0m

• Slim Type

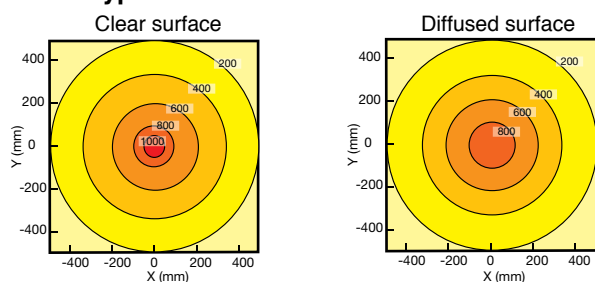

• Wide Type

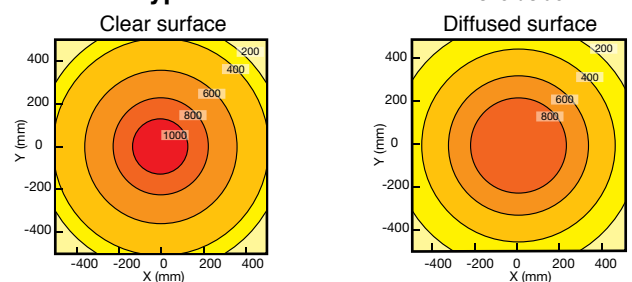

X: long side
Y: short side

Clear surface

Diffused surface

Terminal Block Wiring

• Slim Type

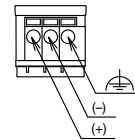

• Wide Type

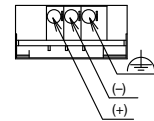

Applicable ferrules: 0.25 to 0.75 mm²

Recommended source:

Phoenix Contact:

AI 0,25-12 BU, AI 0,34-12 TQ,

AI 0,5-12 WH, AI 0,75-12 GY

Internal Circuit

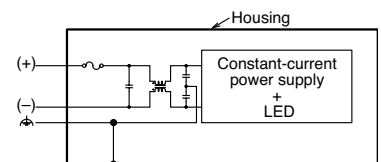

LUMIFA™ LF1D/LF2D LED Illumination Units

Dimensions

All dimensions in mm.

• LF1D-E (Slim Type, 10 LEDs × 1 row)

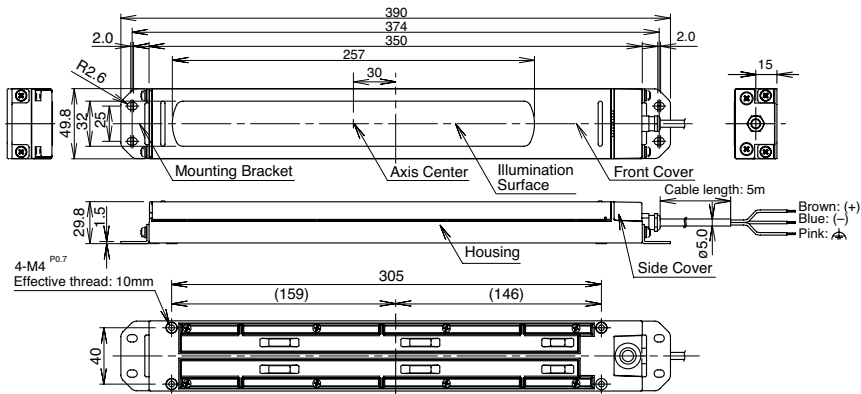

• Mounting Hole Layout

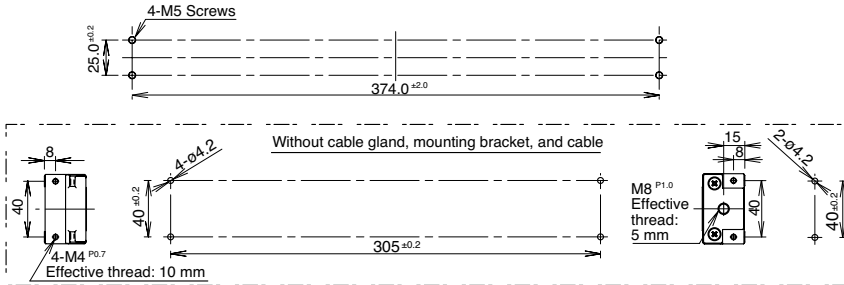

• LF1D-F (Wide Type, 7 LEDs × 2 rows)

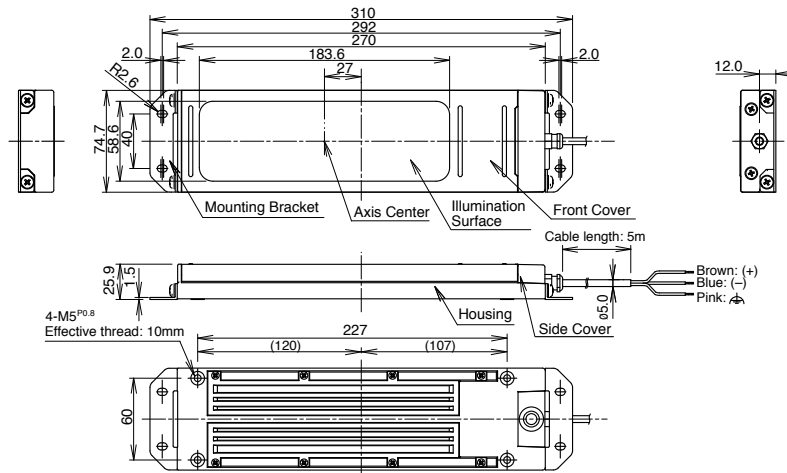

• Mounting Hole Layout

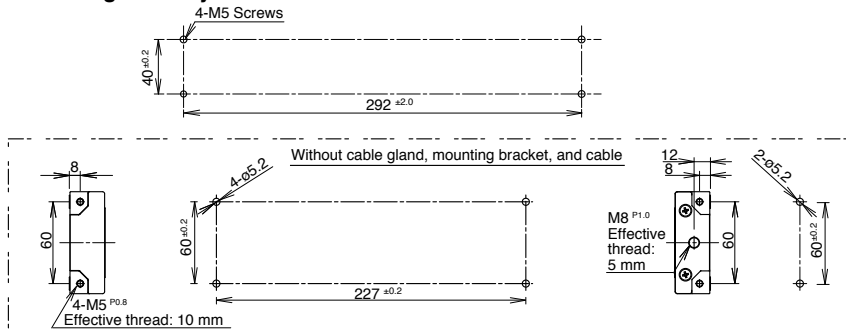

LUMIFA™ LF1D/LF2D LED Illumination Units

Dimensions

• LF2D-E (Slim Type, 10 LEDs × 1 row)

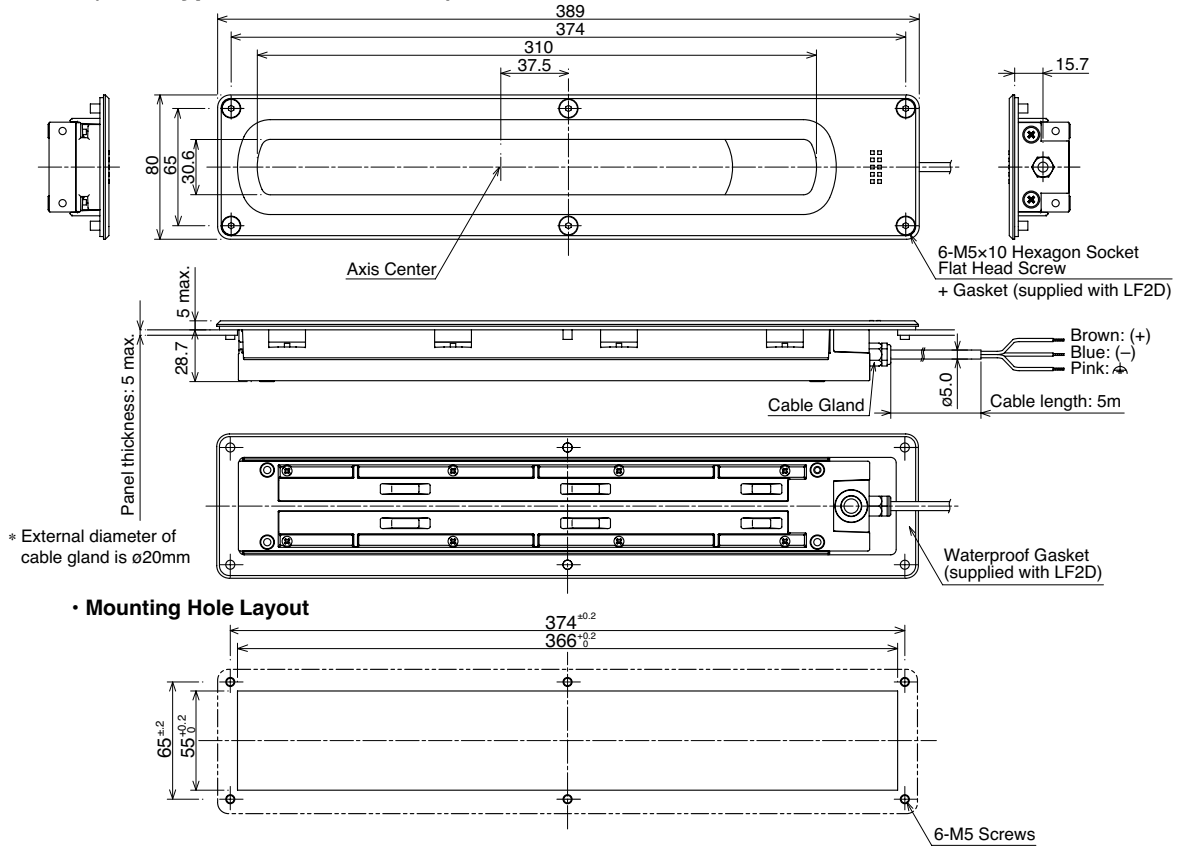

• LF2D-F (Wide Type, 7 LEDs × 2 rows)

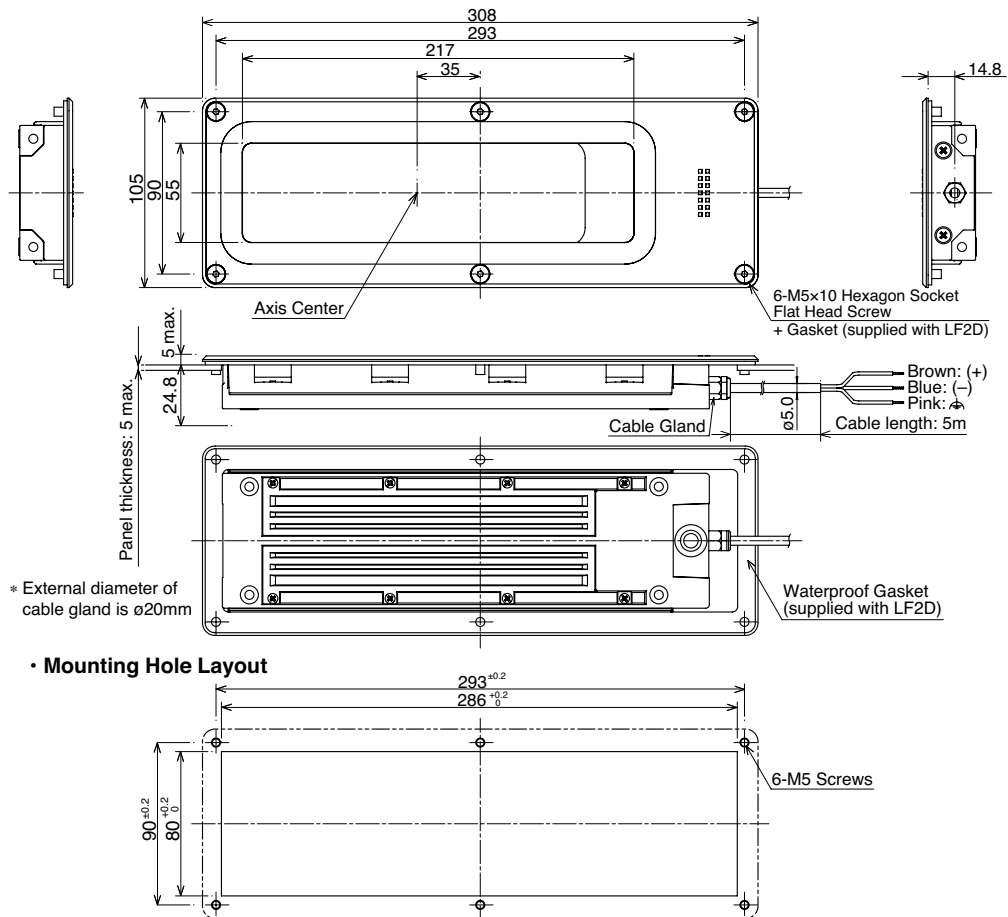



Safety Precautions

- Do not disassemble, repair, or modify illumination units. Otherwise electric shock, fire, or malfunction may occur.
- Turn off power to the illumination units before wiring. Make sure of correct wiring, otherwise electric shock or damage may result.
- Do not stare directly into the illumination unit while it is lit, and do not project the light to other people, otherwise eyes may be injured.
- The illumination unit is a general-purpose industrial electric device. Do not use the illumination unit for electronic equipment which may damage the human body or threaten life in case a malfunction or failure occurs.

Instructions

- Before designing final equipment and powering up illumination units, confirm the specifications described on the instruction sheet. If there is any uncertainty, contact IDEC before powering up illumination units.
- Apply voltage within the rated value, otherwise the LED elements may be damaged.
- The illumination unit is vulnerable to static electricity. Take sufficient measure for protection against static electricity and voltage surges.
- Make sure that the illumination unit does not fall during transportation, installation, and operation, otherwise damage may result.
- Do not pull or push the cable of the illumination unit, otherwise damage may result. Allow sufficient slack to the cable while wiring.
- Do not apply excessive force to the illumination unit. Do not leave a damaged illumination unit unattended or use a damaged illumination unit.
- Ensure the correct operating temperature around the illumination unit. Otherwise internal temperature rise may result in damage.
- Do not use or store the illumination unit in a place subjected to vibration and shock.
- Do not use the illumination unit in the following places:
 - * Exposed to direct sunlight, near heaters, and at high temperatures
 - * Subject to chemicals, and corrosive gases (Plastic illumination surface types: Iron powder and oil)
 - * Basements, greenhouses, or other humid places
 - * Cold storage warehouses and cooler exhaust outlets (make sure that no freezing occurs)
- Do not loosen screws, otherwise the protection characteristics will be impaired.
- For the LF2D illumination units, make sure to provide sufficient strength for mounting panel. Required waterproof characteristics cannot be obtained if a distorted mounting panel is used.
- Use illumination units with a Class 2 power supply.

Specifications and other descriptions in this catalog are subject to change without notice.



IDEC CORPORATION

7-31, Nishi-Miyahara 1-Chome, Yodogawa-ku, Osaka 532-8550, Japan
Tel: +81-6-6398-2571, Fax: +81-6-6392-9731
E-mail: marketing@idec.co.jp

IDEC CORPORATION (USA)

1175 Elko Drive, Sunnyvale, CA 94089-2209, USA
Tel: +1-408-747-0550 / (800) 262-IDEC (4332)
Fax: +1-408-744-9055 / (800) 635-6246
E-mail: opencontact@idec.com

IDEC CANADA LIMITED

3155 Pepper Mill Court, Unit 4, Mississauga, Ontario, L5L 4X7, Canada
Tel: +1-905-890-8561, Toll Free: (888) 317-4332
Fax: +1-905-890-8562
E-mail: sales@ca.idec.com

IDEC AUSTRALIA PTY. LTD.

2/3 Macro Court, Rowville, Victoria 3178, Australia
Tel: +61-3-9763-3244, Toll Free: 1800-68-4332
Fax: +61-3-9763-3255
E-mail: sales@au.idec.com

IDEC ELECTRONICS LIMITED

Unit 2, Beechwood, Chineham Business Park, Basingstoke, Hampshire RG24 8WA, UK
Tel: +44-1256-321000, Fax: +44-1256-327755
E-mail: sales@uk.idec.com

IDEC ELEKTROTECHNIK GmbH

Wendenstrasse 331, 20537 Hamburg, Germany
Tel: +49-40-25 30 54 - 0, Fax: +49-40-25 30 54 - 24
E-mail: service@idec.de

IDEC (SHANGHAI) CORPORATION

Room 608-609, 6F, Gangtai Plaza, No. 700, Yan'an East Road, Shanghai 200001, PRC
Tel: +86-21-5353-1000, Fax: +86-21-5353-1263
E-mail: idec@cn.idec.com

IDEC (BEIJING) CORPORATION

Room 211B, Tower B, The Grand Pacific Building, 8A Guanghua Road, Chaoyang District, Beijing 100026, PRC

Tel: +86-10-6581-6131, Fax: +86-10-6581-5119

IDEC (SHENZHEN) CORPORATION

Unit AB-3B2, Tian Xiang Building, Tian'an Cyber Park, Fu Tian District, Shenzhen, Guang Dong 518040, PRC
Tel: +86-755-8356-2977, Fax: +86-755-8356-2944

IDEC IZUMI (H.K.) CO., LTD.

Units 11-15, Level 27, Tower 1, Millennium City 1, 388 Kwun Tong Road, Kwun Tong, Kowloon, Hong Kong
Tel: +852-2803-8989, Fax: +852-2565-0171
E-mail: info@hk.idec.com

IDEC TAIWAN CORPORATION

8F-1, No. 79, Hsin Tai Wu Road, Sec. 1, Hsi-Chih, Taipei County, Taiwan
Tel: +886-2-2698-3929, Fax: +886-2-2698-3931
E-mail: service@tw.idec.com

IDEC IZUMI ASIA PTE. LTD.

No. 31, Tannery Lane #05-01, HB Centre 2, Singapore 347788
Tel: +65-6746-1155, Fax: +65-6844-5995
E-mail: info@sg.idec.com