

## » JOY SR HC 3AO RS485 Modbus

Electronic Room Thermostat

**thermokon**<sup>®</sup>  
HOME OF SENSOR TECHNOLOGY

### Datasheet

Subject to technical alteration  
Issue date: 01.04.2019 • A102



### » APPLICATION

The 24 V supplied type 3AO has three 0..10 V outputs for controlling heating/cooling valves or a 6-way valve. The analog output is also used to control a 6-way valve. Two configurable inputs can be used as sensor input, room occupancy or energy lock. In addition to wired valve drives and sensors, sensors and actuators can also be controlled by radio. In addition, as an alternative to wired sensors, an external radio temperature sensor, radio motion detector, a radio temperature sensor for changeover function and radio window contacts/handles can be learnt in. The override by radio is possible by means of higher-level controller profile and cable-bound via Modbus. Radio and wired sensors and actuators are processed identically and can be used in any combination. This guarantees individual and energy-efficient room air conditioning. The device (front of glass in white or black) has a monochrome display and touch-sensitive control buttons. It has a timer with three time channels of four time periods each. Mounting is designed for a flush-mounted box. For hotel applications, the device offers the option of an additional zone (bathroom heating) in conjunction with room temperature sensor and radio actuator SAB.

### » SECURITY ADVICE – CAUTION



The installation and assembly of electrical equipment should only be performed by authorized personnel.

The product should only be used for the intended application. Unauthorised modifications are prohibited! The product must not be used in relation with any equipment that in case of a failure may threaten, directly or indirectly, human health or life or result in danger to human beings, animals or assets. Ensure all power is disconnected before installing. Do not connect to live/operating equipment.

Please comply with

- Local laws, health & safety regulations, technical standards and regulations
- Condition of the device at the time of installation, to ensure safe installation
- This data sheet and installation manual

### » NOTES ON DISPOSAL



As a component of a large-scale fixed installation, Thermokon products are intended to be used permanently as part of a building or a structure at a pre-defined and dedicated location, hence the Waste Electrical and Electronic Act (WEEE) is not applicable. However, most of the products may contain valuable materials that should be recycled and not disposed of as domestic waste. Please note the relevant regulations for local disposal.

## » REMARKS TO ROOM SENSORS

### Location and Accuracy of Room Sensors

The room sensor should be mounted in a suitable location for measuring accurate room temperature. The accuracy of the temperature measurement also depends directly on the temperature dynamics of the wall. It is important, that the back plate is completely flush to the wall so that the circulation of air occurs through the vents in the cover. Otherwise, deviations in temperature measurement will occur due to uncontrolled air circulation. Also the temperature sensor should not be covered by furniture or similar devices. Mounting next to doors (due to draught) or windows (due to colder outside wall) should be avoided.

The temperature dynamics of the wall will influence the temperature measurement. Various wall types (brick, concrete, dividing and hollow brickwork) all have different behaviours with regards to thermal variations.

### Surface and Flush Mounting

The temperature dynamics of the wall influence the measurement result of the sensor. Various wall types (brick, concrete, dividing and hollow brickwork) have different behaviours with regard to thermal variations. A solid concrete wall responds to thermal fluctuations within a room in a much slower way than a light-weight structure wall. Room temperature sensors installed in flush boxes have a longer response time to thermal variations. In extreme cases they detect the radiant heat of the wall even if the air temperature in the room is lower for example. The quicker the dynamics of the wall (temperature acceptance of the wall) or the longer the selected inquiry interval of the temperature sensor is the smaller the deviations limited in time are.

## » TECHNICAL DATA

Measuring values	temperature	
Network technology	RS485 Modbus, baud rate 9.600, 19.200, 38.400 or 57.600, parity none (2 stopbits), even or odd (1 stopbit)	
Radio technology	EnOcean (IEC 14543-3-10)	
Frequency	868 MHz	
Output voltage	3x 0..10 V, max. load 5 mA, 6-way valve control, heating & cooling	
Power supply	24 V = ( $\pm 10\%$ ) or 24 V ~ ( $\pm 10\%$ ) SELV	
Power consumption	max. 1,5 W (24 V =)	
Measuring range temp.	0..+50 °C	
Accuracy temperature	$\pm 1$ K (typ. at 21 °C)	
Inputs	<b>DI 1</b> 1 input for NTC10K or floating contact	<b>DI 2</b> 1 input for floating contact
Control function	setpoint adjustment 0..+50 °C	
Display	LCD 2,5", 240x160 px, white backlighting	
Functions	integrated PI-controller, MSG server for 2nd control loop via radio	
Enclosure	PC and glass, optional black or white	
Protection	IP30 according to EN 60529	
Connection electrical	<b>Terminal 1..8</b> terminal block max. 1,5 mm <sup>2</sup>	<b>Terminal 9..12</b> terminal block max. 1.0 mm <sup>2</sup>
Ambient condition	0..+50 °C, max. 85% rH non-condensing	
Weight	195 g	
Mounting	flush mounted with standard EU box ( $\varnothing=60$ mm)	
Notes	there are 20 EnOcean transmit / receive channels available for various functions	

## » PRODUCT TESTING AND CERTIFICATION



### Declaration of conformity

The declaration of conformity of the products can be found on our website <https://www.thermokon.de/>.

## » INFORMATION ABOUT EASYSENS® (RADIO) / AIRCONFIG GENERAL USAGE



### EasySens® - airConfig

Basic information about EasySens® radio and about general usage of our airConfig software, please download from our website.

## » OVERVIEW OF THE RADIO TELEGRAMS



### EEP

The structure of the data contained in the telegram can be found in the EEP (EnOcean equipment profile) list provided by the EnOcean Alliance.

## » DIAGNOSTICS MENU

To access the diagnostics menu, select the header in the startscreen of the parameter menu, and press the ENTER key. Here you will find various information, such as device type, software version, state of the inputs and outputs and controller state (current manipulated variable).

## » MOUNTING ADVICES

Plasterboard boxes shall be covered by wall paper or paint to avoid that the plasterboard box's front rim will be partially visible underneath JOY. Maybe consider using white plasterboard boxes (i.e. Kaiser 9063-77)

## » SUPPORTED PROFILES

### Receiving profiles

EnOcean-EEP	Type	Direction	Description	Thermokon Devices	Max. Quantity	LCD/ Funktions-gruppe
F6-02-01	RPS	Rx	EnOcean button	Diverse	1	RPS
D5-00-01	1BS	Rx	Windows contacts	SRW01	max.5	SRW
F6-10-00	RPS	Rx	Windows handle	SRG02		SRG
A5-02-06	4BS	Rx	Temperature 0-50°C	SR65 VFG, SR65 TF, SR65 AKF, SR65	1	VFG
A5-02-16	4BS	Rx	Temperature 0-80°C			VFG
A5-02-05	4BS	Rx	Room Sensor (Temperature 0-40°C)	SR04, LC-SR04, SR07, SR65	1	EXT
A5-10-03	4BS	Rx	(Room Operating Panel) Temperatur, Set Point	SR07P, SR04P, SR06 2T/2T+		WRF
A5-07-01	4BS	Rx	Room Sensor (Occupancy)	SR-MDS Solar, SR-MOC Solar, SR-MOW Solar	max. 3	OCC
A5-08-01	4BS	Rx	Room Sensor (Occupancy, Light, Temperature)	SR-MDS		OCC
F6-04-01	RPS	Rx	Keycard	SR-KCS02, SR-KCS	1	KEY
A5-20-01	4BS	Rx/Tx	SAB	SAB+, SAB05	max. 6	SAB
A5-20-12	4BS	Rx	Superior Control Unit (Fan. Set Point, Controller, Energy Hold OFF/Dew point, Occup)		1	SUP

### Transmitting profiles

EnOcean-EEP	Type	Direction	Description	Max. Quantity	LCD
A5-10-02 (V2.1.1 +)	4BS	Tx	<b>Valid from Version 2.1.1 (up to 2.1.0: A5-10-01)</b> Room operating panel (Fan, Temp, Sollwert, Occup)	1	WRF
A5-10-06 (V2.1.1 +)	4BS	Tx	<b>Valid from Version 2.1.1 (up to 2.1.0: A5-10-05)</b> Room operating panel (Temp, Sollwert, Occup)		
A5-11-02	4BS	Tx	Temperature Controller (Fan, Set point, alarming, Controller state, Energy Hold OFF, Occup)	1	OUT
A5-20-01	4BS	Rx/Tx	SAB	max. 5+1	SAB

### » CONNECTION PLAN

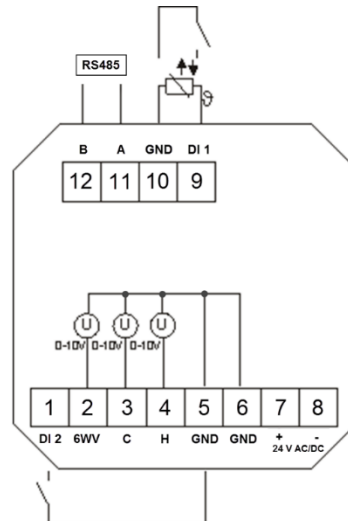

1 Digital Input 2	12 Modbus B
2 6-way valve (0..10 V)	11 Modbus A
3 Cooling (0..10 V)	10 GND DI 1
4 Heating (0..10 V)	9 Digital Input 1 (or NTC10K)
5 GND DI 2	
6 GND	
7 24 V = ( $\pm 10\%$ ) or 24 V ~ ( $\pm 10\%$ )	
8 GND	

### » FUNCTION DESCRIPTION - BUTTONS

On the touch-surface are the keys for setpoint adjustment. While pressing of these buttons, the white LED of the Power-button lights up for visual feedback.

The room thermostat can be set in standby mode by pressing the power button (E) for at least 3 seconds.



The buttons (A) and (C) change the setpoint in the range  $\pm 3^\circ\text{C}$  (default setting, configurable).

With power-button (E), the device can be set in standby mode by pressing the button (if keycard-switch is NOT used). If the button is used as a occupancy button, the button must be pressed for at least 3s, in all other cases, a short actuation is sufficient. In standby mode, the display and all outputs are switched off (controller deactivated). The frost and heat protection monitoring remains active. **Modbus registers can still be read (e.g. room temperature).**

» **FUNCTION DESCRIPTION – CONTROLLER**

The room thermostat has a "PI controller" for heating and cooling.

**6WV (PI-controller 0..10 V)**

The manipulated variable is output as a proportional control signal at the output for the 6-way valve. The type of valve used is set via the configuration software. You can choose from 2..10 V / 2..10 V INV (Belimo), 0..10 V DN15 / DN15 INV, DN20 / DN20 INV (Sauter).

**Heating/ cooling with PI-controller (0..10 V)**

The time response of the PI control loop depends on the control parameters xp for the proportional area and tn for the reset time of the integral range. In case of an error variable, the P portion immediately changes the position value proportionally to the error variable, while the integral portion takes effect after a certain time.

**The resulting manipulated variable is output as an analogue 0..10 V signal directly to the outputs.**

**Proportional range Xp**

The proportional band is the deviation in which controller emits 100% value. A small Xp leads to a stronger control action in case of slight deviations, but increases the oscillation tendency.

**Integral time Tn**

The reset time Tn is the time which the I-component of the controller would require to produce the same positioning signal that the P-component forms immediately once the control deviation is present. The effect of the I component decreases with increasing reset time.

**Minimum and maximum actuating variable**

This setting defines a fixed minimum or maximum value of the actuating variable. The parameter "Mode selection actuating variable" can be used to select whether the minimum actuating variable a) is retained until the controller changes mode or b) whether the actuating variable of the controller is output to the output only when the minimum actuating variable is exceeded.

**Main screen/ Value display**

The Display shows the measured value of the internal sensor. The value of an external sensor will be shown if connected and configured accordingly. In this case the room thermostat controls to the external sensor.

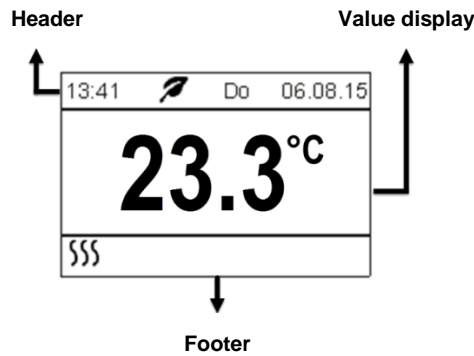

**Header**









Current date and time will be displayed in the header. If enabled, ECO-mode status is indicated via symbol .

An attention symbol  can be displayed in the header. This symbol has a higher priority than the ECO-mode symbol and is prefixed instead of this.

**Footer**

Depending upon the heating or cooling mode, occupancy or window contact status, the corresponding symbols will be shown in the footer. The symbol "active timechannel" will be shown only if active.

**Symbols**

Occupancy	 
Window contact/dew point	 
Heating/Cooling	 
Active timechannel	 

**» CONFIGURATION**

**Navigation**

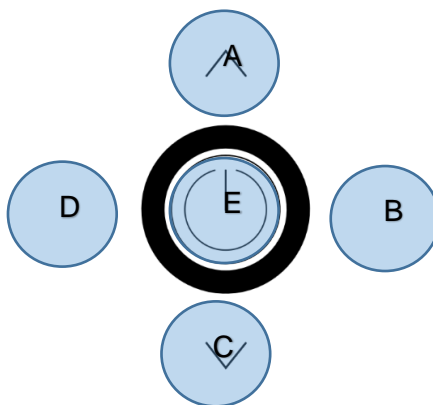

Menu navigation on the touch-surface is performed by pressing the buttons "up" (A), "down" (C), "left" (D), "right" (B) or the power button. Choose the desired parameter and press "right" (B) to open up the submenu. The menu will default after 30 seconds if no button is pressed. To exit the menu select the header line and press "left" (D).

**Enter Parameter Menu**

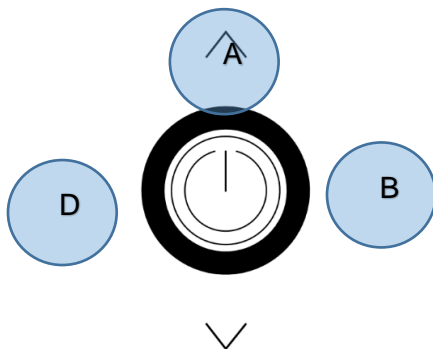

The configuration menu is called up by simultaneously pressing the buttons "up" (A), "left" (D) and "right" (B) for at least 3 seconds.

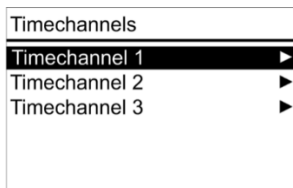

**Time channels**

**After commissioning, the device must be supplied with power for at least 12 h so that the internal energy storage device is charged. In case of a power failure the internal real-time clock is stored for at least 60 days.**

Set point and timer can be set in this menu. Three different time channels with four periods of time are available. The Time channels are prioritised. Channel 3 has the highest priority.

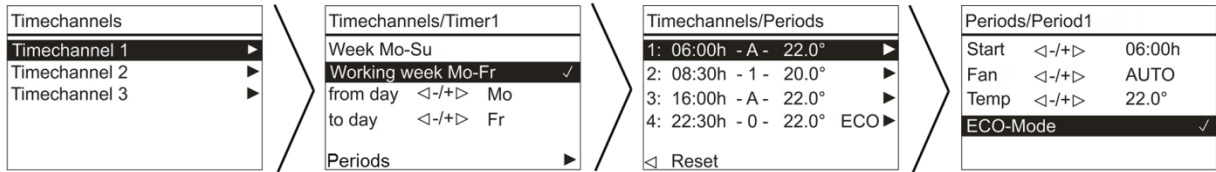

Choose the time channel and press "right" to enter the submenu. It is possible to select the total week as well as individual days

The selected parameter will be marked with the symbol ✓

To edit the parameter of the selected timer, select "Periods" and press "right".

ECO-mode is also available in the menu "section", when selecting the dead zone increase from 2 °C to 10 °C. The adjustable dead zone between the activation of heating or cooling modes enables an optimisation between comfort and energy saving.

The dead zone between heating and cooling in the ECO-mode will be set to the configured dead band range (see common settings, default 10.0 K).

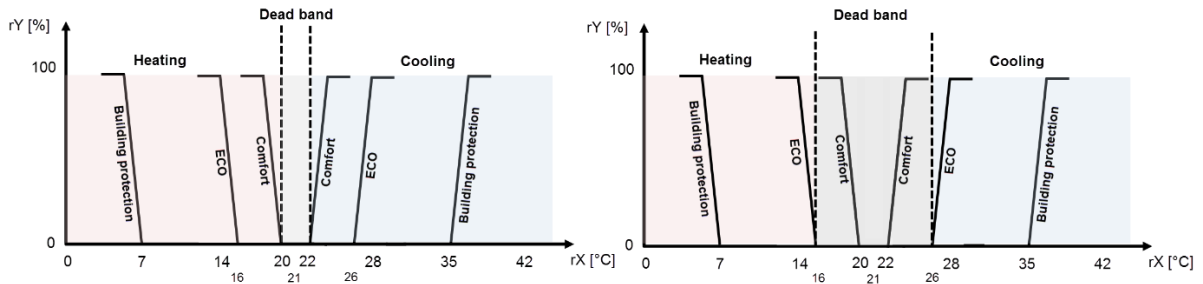

Further information for the parameterisation of the time channels, please refer the detailed description of the JOY Modbus.

**Modbus Parameter Menu**

The configuration menu is activated by simultaneously pressing the buttons "up" (A), "down" (C) for at least 5 seconds.

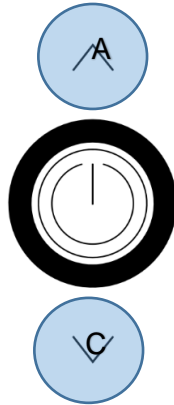

Modbus settings		
Address	<-/+>	32
Baudrate	<-/+>	19200
Parity	<-/+>	Even

**Address (default: 32)**  
Adjustable address (1-247)

**Baud rate (default: 19200)**  
9600Bd | 19200Bd | 38400Bd | 57600Bd

**Parity (default: even)**  
Non | odd | even

**» INPUTS**

2 inputs are configurable for functions such as windows contact, dew point, occupancy, change-over or external sensor option.

**Sensor (NTC10K)**

The value of an external sensor will be shown if connected and configured accordingly. In this case, the room thermostat controls according to the external sensor.

**Change-Over DI**

Which controller is active depends on the state of the Change-Over contact. (Factory default: contact open heating controller active, contact closed cooling controller active). The terminals 3 and 4 are used as outputs for heating resp. cooling.

**Change-Over Sensor**

The Change-Over Sensor is used for switching between heating and cooling mode automatically. If the temperature is below 19 ° C, the controller is in cooling mode. If it is above 28 ° C, it is a heating mode.

If an input is configured as a change-over, the room thermostat is automatically in 2-pipe operating mode and both outputs (terminals 3 and 4) are used as outputs for heating resp. cooling.

**Window contact/Energy hold off**

If a window contact is enabled via the digital input, the reference will switch to a setback set point (Heat SP/Cool SP).

**Dewpoint**

An active dewpoint contact locks the cooling controller.

**Occupancy**

If occupancy-function is active, the symbol will be displayed automatically. In state of "unoccupied" the heating set point is reduced by 2K (default setting) resp. the cooling set point raised by 2K.

**Keycard-Switch**

When the card is not inserted, the device is switched in sleep mode. Operation of the keys is locked, the display is switched off and the controller adjusts to the nominal values of the "unoccupied"-State.



» **ENOCEAN**

There are 20 channels available that can be assigned different functions. A channel can be configured as a receive channel, as a send channel or as a message server (SAB communication).

6 channels can be configured with SAB valve actuator, one of these can be set with the bath function. For the SAB with the bath function, an additional setpoint offset can be set. If SAB valve actuators are learned in, the analogue outputs to the internal controller remain active and can also be used.

**Functional Overview SAB**

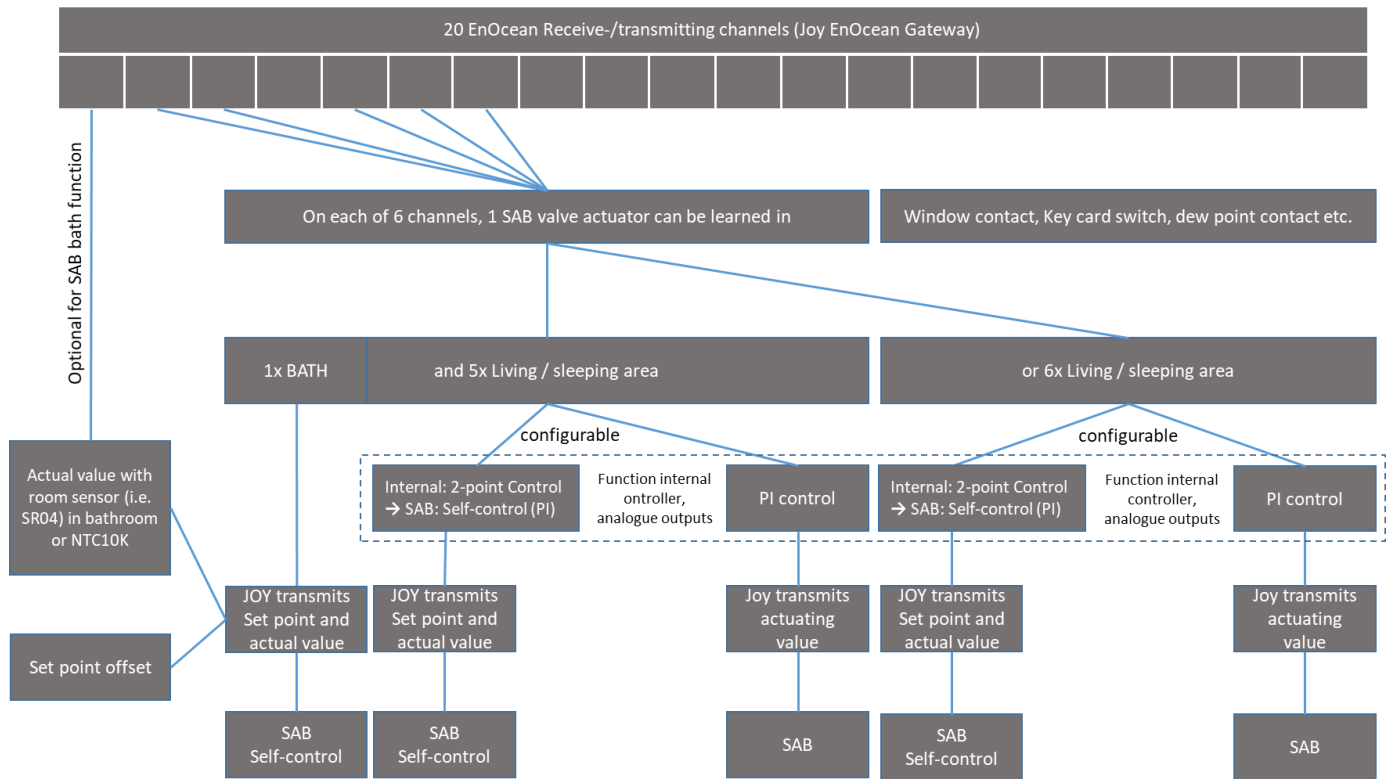

**The profiles used are divided into functional groups**

<b>SRW/SRG</b>	Window contact and window handle. Both have an influence on the window contact function and are linked to the digital inputs or the Modbus default. Up to five sensors can be learned-in.
<b>VFG</b>	Sensor for changeover control. Only one changeover sensor can be learned in.
<b>EXT/WRF</b>	Receiving channel: Temperature preset by an external room temperature sensor. Overrides the internal temperature sensor. Max. one sensor can be learned in. An EnOcean room operating unit is displayed on the send channel.
<b>OCC</b>	Up to 3 motion sensors can be learned in and affect the occupancy function. The last changed value (Modbus, EnOcean, Button) will be accepted. If several EnOcean motion sensors have been learned-in, the "ROOM UNOCCUPIED" value will only be accepted once all sensors have signaled "ROOM UNOCCUPIED".
<b>KEY</b>	Controls the internal keycard function. When learning a key card switch, the card must not be plugged in AND pulled immediately during the learn-in process. It is necessary to wait at least 5 seconds until the second action is performed with the card. Only then will the switch be assigned as key card switch, otherwise it will be learned in as a radio rocker switch (function group RPS).
<b>SUP</b>	A superior control unit to override the internal functions.
<b>SAB (5+1 Bath)</b>	Up to 6 SAB's can be learned in. One pcs. can be assigned with the „Bath“ function. The other channels can be used optionally for heating or cooling. For each SAB channel, an offset for the setpoint can be configured via Modbus.
<b>OUT</b>	Only in direction of transmission. A controller status (A5-11-02) every 15 minutes (configurable) and with every change of any value.

**Commissioning**

Two additional selection menus appear in the menu, <EnOcean list> and <EnOcean configuration>. The EnOcean list is a simple list display of the EnOcean sensors that have been taught in, in addition to the list, further information on the individual sensors can be called up.

**EnOcean list**

Menu
Timechannel ▶
Time/Date ▶
EnOcean list ▶
EnOcean configuration ▶

All channels with the learned sensors or actuators are displayed in this list.

With <Selection>, detailed information are displayed:

1 Rx 01-8C-03-98 EXT !!	<b>Index:</b> 2 <b>ID:</b> FF-81-CC-01 <b>Dir:</b> Rx <b>Typ:</b> SAB <b>EEP:</b> A5-20-01_B <b>SAB-Ch:</b> 2 <b>RSSI:</b> -67dB <b>Time:</b> 340s <b>Errors:</b> 00001 <b>Pending:</b> Y <b>Sensor Channel:</b> 2 ENTER to acknowledge
2 Rx FF-81-CC-01 OCC	
3 FF-FF-FF-FF	
4 <b>Rx</b> FF-81-CC-03 SAB	
5 Rx FF-81-CC-00 VFG !!!	
6 Rx 00-8B-CE-DA KEY	
< Selection >	

**EnOcean configuration**

In this menu item, the radio channels can be configured and individual information can be called up.

Menu
Timechannel ▶
Time/Date ▶
EnOcean list ▶
EnOcean configuration ▶

In the footer, various menu items can be selected with the LEFT / RIGHT keys and the corresponding menu item is selected with the ENTER key.

SAB valve actuators are learned in with the function <SET ACTOR>.

1	FF-FF-FF-FF	EXIT    DELETE CHANNEL    < LEARN SENSOR >    SET ACTOR    SHOW CHANNEL
2	FF-FF-FF-FF	
3	FF-FF-FF-FF	
4	<b>FF-FF-FF-FF</b>	
5	FF-FF-FF-FF	
6	FF-FF-FF-FF	

The access to the menu <EnOcean configuration> can be protected with a password via Modbus. The login remains unlocked in the EnOcean menu until 10 minutes after the last key press. Default password: 2030.

More detailed information for the configuration of the EnOcean channels can be found in the specification.

**» APPLICATION NOTICE**

**Boot Loader**

A bootloader integrated in the device, makes it possible to install a new application (update, upgrade) using a MicroSD card. To insert the SD card, the upper part must be removed. If the boot loader is activated, the ring illumination blinks in a 1s cycle, while display is not triggered! After recognition of a MicroSD card with a valid application the update process is started. Now, ring illumination blinks fast in a 300ms cycle. After a successful update process (Duration approx. 20-30 seconds!), the new application is started automatically. Afterwards, SD card have to be removed! A firmware update can also be performed via the Modbus interface. In this case, the program "Thermokon Bootloader" (as of version 2.0.0) and the corresponding firmware file are needed.

**SD-Card**

The parameterization of the receive channels for EasySens transmitter (i.e. SRW0x window contact) and the configuration of the device can be done with a MicroSD card. You can create a configuration file with the Thermokon tool uConfig. This means that sensors can be learned-in without having to press the LRN buttons of the relevant sensors.

The MicroSD card can also be used to read a configuration from the JOY. The MicroSD card can be plugged in during the current configuration or it can be used after the configuration has been completed. If a MicroSD card is inserted during the configuration, each learn / learn process is wrote directly into the file. If the MicroSD card is inserted after the configuration, the configuration file is automatically created on the card after a restart.

Note: EasySens receivers such as SAB or actuators need the ID of the transmitter (Joy) via manually initiated teach-in telegram. Only MicroSD cards formatted in the FAT file system can be used! NTFS and exFAT file systems are not supported.

## Software uConfig

A detailed description of the parameter and the configuration software uConfig can be downloaded from our website.

**The parameters for the display, set point, controller and the 6-way valve output configuration can only be changed via the configuration software.**

→ [Download for Windows](#)

→ [Download for Mac OS](#)

## » DIMENSIONS (MM)

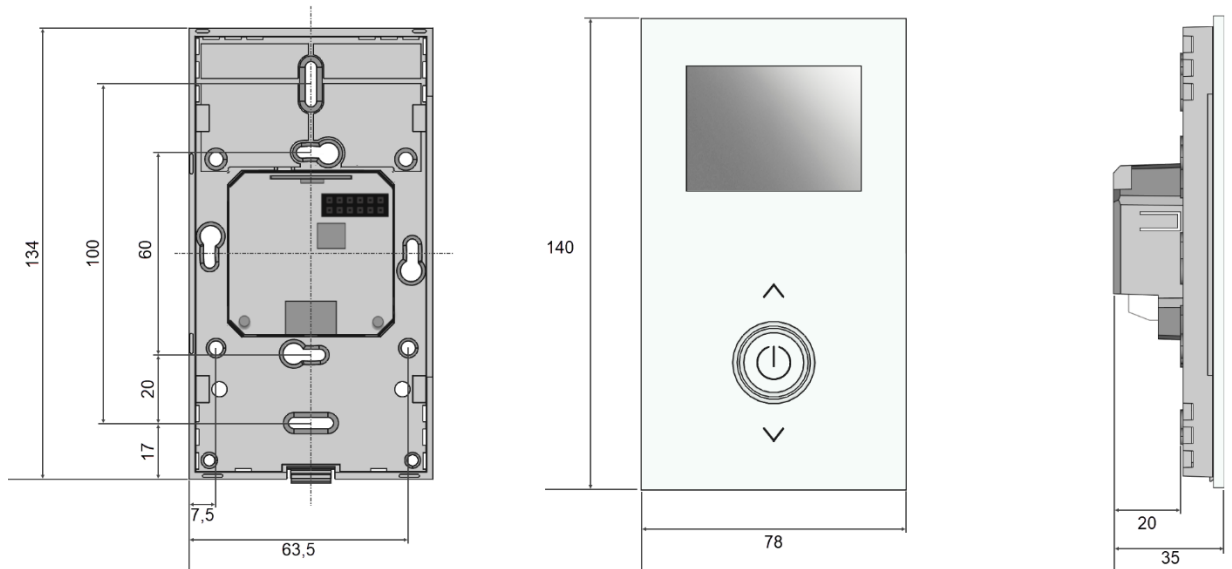

## » ACCESSORIES (OPTIONAL)

Converter RS485 Modbus - USB  
Decorative frame pure white for JOY  
MicroSD card 2GB

Item No. 668293  
Item No. 614771  
Item No. 500098