

Datasheet

Subject to technical alteration
Issue date: 24.11.2017 • A002



Application

Modern design, flush mounting room thermostat. Used for individual control of temperature in commercial, industrial and residential buildings. It is tailored for two-pipe and four-pipe units with two-wire electric valves and controlling a 6-way valve (Sauter or Belimo). The device combines a modern design with a 2,5" LCD and a touch-sensitive surface, 3 time program options each with 4 time periods options.

Security Advice – Caution



The installation and assembly of electrical equipment should only be performed by authorized personnel.

The product should only be used for the intended application. Unauthorised modifications are prohibited! The product must not be used in relation with any equipment that in case of a failure may threaten, directly or indirectly, human health or life or result in danger to human beings, animals or assets. Ensure all power is disconnected before installing. Do not connect to live/operating equipment.

Please comply with

- Local laws, health & safety regulations, technical standards and regulations
- Condition of the device at the time of installation, to ensure safe installation
- This data sheet and installation manual

Notes on Disposal



As a component of a large-scale fixed installation, Thermokon products are intended to be used permanently as part of a building or a structure at a pre-defined and dedicated location, hence the Waste Electrical and Electronic Act (WEEE) is not applicable. However, most of the products may contain valuable materials that should be recycled and not disposed of as domestic waste. Please note the relevant regulations for local disposal.

Remarks to Room Sensors

Location and Accuracy of Room Sensors

The room sensor should be mounted in a suitable location for measuring accurate room temperature. The accuracy of the temperature measurement also depends directly on the temperature dynamics of the wall. It is important, that the back plate is completely flush to the wall so that the circulation of air occurs through the vents in the cover. Otherwise, deviations in temperature measurement will occur due to uncontrolled air circulation. Also the temperature sensor should not be covered by furniture or similar devices. Mounting next to doors (due to draught) or windows (due to colder outside wall) should be avoided.

The temperature dynamics of the wall will influence the temperature measurement. Various wall types (brick, concrete, dividing and hollow brickwork) all have different behaviours with regards to thermal variations.

Surface and Flush Mounting

The temperature dynamics of the wall influence the measurement result of the sensor. Various wall types (brick, concrete, dividing and hollow brickwork) have different behaviours with regard to thermal variations. A solid concrete wall responds to thermal fluctuations within a room in a much slower way than a light-weight structure wall. Room temperature sensors installed in flush boxes have a longer response time to thermal variations. In extreme cases they detect the radiant heat of the wall even if the air temperature in the room is lower for example. The quicker the dynamics of the wall (temperature acceptance of the wall) or the longer the selected inquiry interval of the temperature sensor is the smaller the deviations limited in time are.

Technical Data

Measuring values	temperature	
Network technology	RS485 Modbus, baud rate 9.600, 19.200, 38.400 or 57.600, parity none (2 stopbits), even or odd (1 stopbit)	
Output voltage	3x 0..10 V, 6-way valve control, heating & cooling	
Power supply	24 V = ($\pm 10\%$) or 24 V ~ ($\pm 10\%$) SELV	
Power consumption	max. 1,5 W (24 V =)	
Measuring range temp.	0..+50 °C	
Accuracy temperature	± 1 K (typ. at 21 °C)	
Inputs	DI 1 1 input for NTC10K or floating contact	DI 3 1 input for floating contact
Control function	setpoint adjustment 0..+50 °C	
Display	LCD 2,5", 240x160 px, white backlighting	
Functions	integrated PI-controller	
Enclosure	PC, hardened acrylic glass with high scratch resistance	
Protection	IP30 according to EN 60529	
Connection electrical	Terminal 1..8 terminal block max. 1,5 mm ²	Terminal 9..12 terminal block max. 1.0 mm ²
Ambient condition	0..+50 °C, max. 85% rH non-condensing	
Weight	195 g	
Mounting	flush mounted with standard EU box ($\varnothing=55$ mm)	

Diagnostics Menu

To access the diagnostics menu, select the header in the startscreen of the parameter menu, and press the ENTER key. Here you will find various information, such as device type, software version, state of the inputs and outputs and controller state (current manipulated variable).

Mounting Advices

Plasterboard boxes shall be covered by wall paper or paint to avoid that the plasterboard box's front rim will be partially visible underneath JOY.

Maybe consider using white plasterboard boxes (i.e. Kaiser 9063-77)

Connection Plan

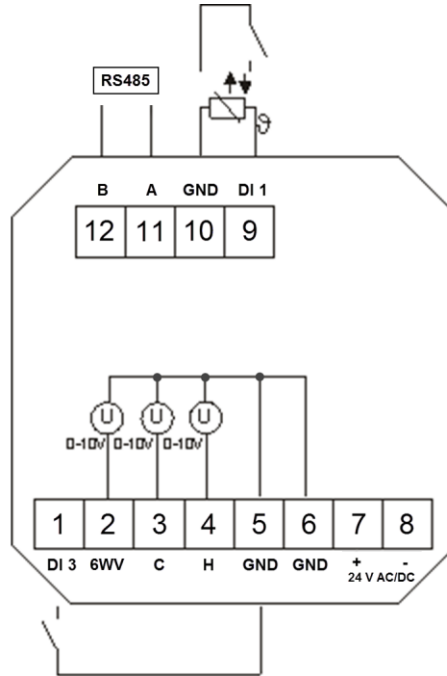

1	Digital Input 3	7	24 V = (±10%) or 24 V ~ (±10%)
2	6-way valve (0..10 V)	8	GND
3	Cooling (0..10 V)	9	Digital Input 1 (or NTC10K)
4	Heating (0..10 V)	10	GND DI 1
5	GND DI3	11	Modbus A
6	GND	12	Modbus B

Function Description - Buttons

On the touch-surface are the keys for setpoint adjustment. While pressing of these buttons, the white LED of the Power-button lights up for visual feedback.

The room thermostat can be set in standby mode by pressing the power button 3 for at least 3 seconds.



The buttons (1) and (2) change the setpoint in the range ± 3 ° C (default setting, configurable).

With power-button (3), the device can be set in standby mode by pressing the button (if keycard-switch is NOT used). If the button is used as a occupancy button, the button must be pressed for at least 3s, in all other cases, a short actuation is sufficient. In standby mode, the display and all outputs are switched off (controller deactivated). The frost and heat protection monitoring remains active.

Modbus registers can still be read (e.g. room temperature).

Function Description – Controller

The room thermostat has a "PI controller" for heating and cooling.

6WV (PI-controller 0..10 V)

The manipulated variable is output as a proportional control signal at the output for the 6-way valve. The type of valve used is set via the configuration software.

You can choose from 2..10 V / 2..10 V INV (Belimo), 0..10 V DN15 / DN15 INV, DN20 / DN20 INV (Sauter).

Heating/ cooling with PI-controller (0..10 V)

The time response of the PI control loop depends on the control parameters x_p for the proportional area and t_n for the reset time of the integral range. In case of an error variable, the P portion immediately changes the position value proportionally to the error variable, while the integral portion takes effect after a certain time.

The resulting manipulated variable is output as an analogue 0..10 V signal directly to the outputs.

Proportional range X_p

The proportional band is the deviation in which controller emits 100% value. A small X_p leads to a stronger control action in case of slight deviations, but increases the oscillation tendency.

Integral time T_n

The reset time T_n is the time which the I-component of the controller would require to produce the same positioning signal that the P-component forms immediately once the control deviation is present. The effect of the I component decreases with increasing reset time.

Minimum and maximum actuating variable

This setting defines a fixed minimum or maximum value of the actuating variable. The parameter "Mode selection actuating variable" can be used to select whether the minimum actuating variable a) is retained until the controller changes mode or b) whether the actuating variable of the controller is output to the output only when the minimum actuating variable is exceeded.

Main screen/ Value display

The Display shows the measured value of the internal sensor. The value of an external sensor will be shown if connected and configured accordingly. The room thermostat controls in this case according to the external sensor.

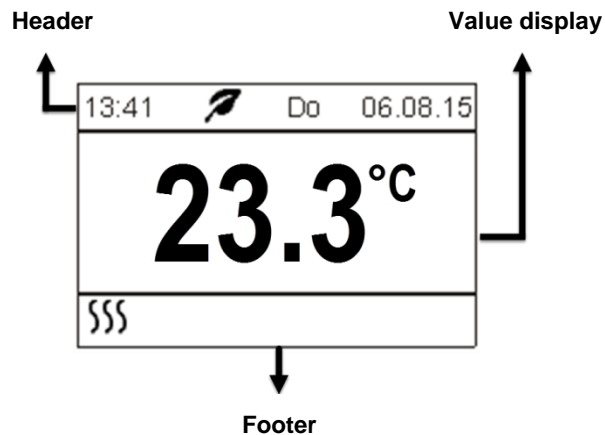

Header









Current date and time will be displayed in the header. If enabled, ECO-mode status is indicated via symbol .

An attention symbol  can be displayed in the header. This symbol has a higher priority than the ECO-mode symbol and is prefixed instead of this.

Footer

Depending upon the heating or cooling mode, occupancy or window contact status, the corresponding symbols will be shown in the footer. The symbol "active timechannel" will be shown only if active.

Symbols

Occupancy		
Window contact/dew point		
Heating/Cooling		
Active timechannel		

Configuration

The setpoint of the Modbus version can be adjusted to any particular requirements or overwritten by a higher-level control.

Navigation

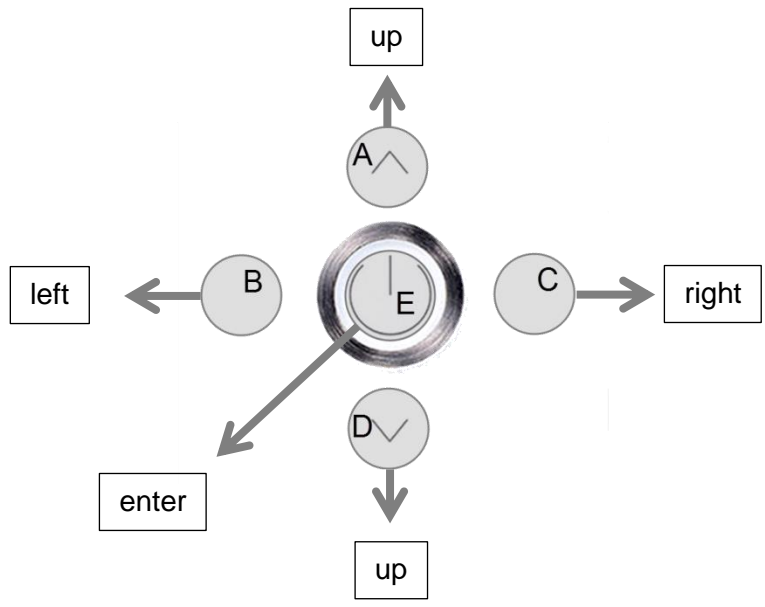

Menu navigation on the touch-surface is performed by pressing the buttons "up" (A), "down" (D), "left" (B), "right" (C) or the power button. Choose the desired parameter and press "right" (C) to open up the submenu. The menu will default after 30 seconds if no button is pressed. To exit the menu select the header line and press "left" (B)

Enter Parameter Menu

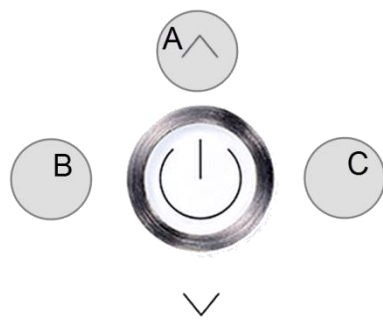

The configuration menu is activated by simultaneously pressing the buttons "up" (A), "left" (B) and "right" (C) for at least 3 seconds.

Timechannels
Timechannel 1
Timechannel 2
Timechannel 3

Time channels

Set point and timer can be set in this menu. Three different time channels with four periods of time are available. The Time channels are prioritised. Channel 3 has the highest priority.

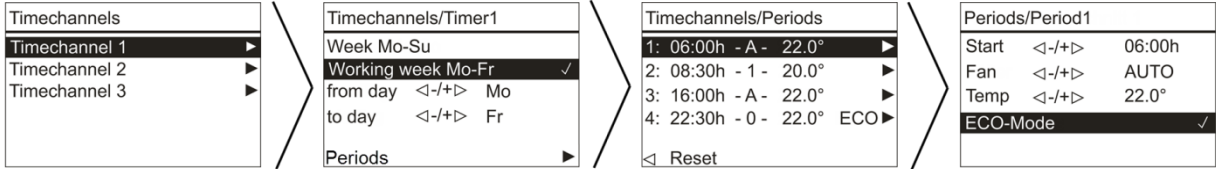

Choose the time channel and press “right” to enter the submenu. It is possible to select the total week as well as individual days
The selected parameter will be marked with the symbol ✓

To edit the parameter of the selected timer, select “Periods” and press “right”.

ECO-mode is also available in the menu “section”, when selecting the dead zone increase from 2 °C to 10 °C. The adjustable dead zone between the activation of heating or cooling modes enables an optimisation between comfort and energy saving.

The dead zone between heating and cooling in the ECO-mode will be set to the configured dead band range (see common settings, default 10.0 K).

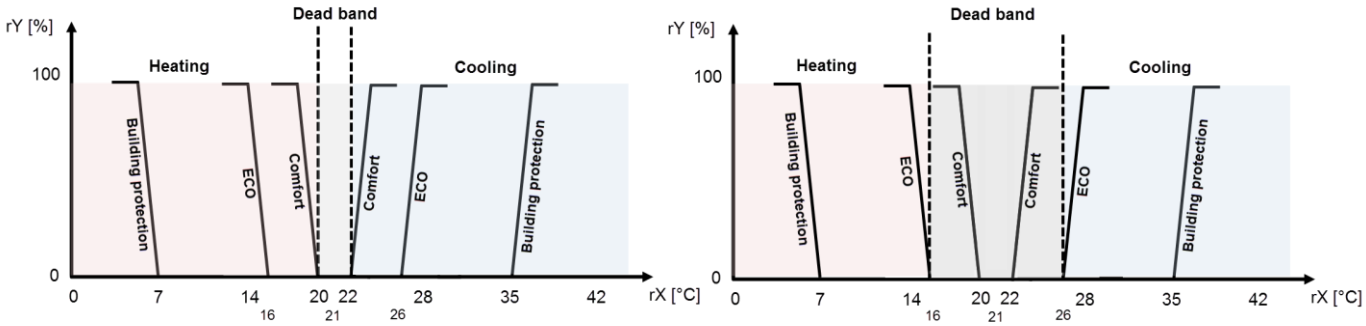

Further information for the parameterisation of the time channels, please refer the detailed description of the JOY Modbus. (See link under **software**)

Modbus Parameter Menu

The configuration menu is activated by simultaneously pressing the buttons “up” (1), “down” (2) for at least 5 seconds.



Modbus settings		
Address	◀-/+▶	32
Baudrate	◀-/+▶	38400
Parity	◀-/+▶	None

Address
Adjustable address (1-247)

Baud rate
9600Bd | 19200Bd | 38400Bd | 57600Bd

Parity
Non | odd | even

Inputs

Up to 3 inputs are configurable for functions such as windows contact, dew point, occupancy, change-over or external sensor option.

Sensor (NTC10K)

The value of an external sensor will be shown if connected and configured accordingly. In this case, the room thermostat controls according to the external sensor.

Change-Over DI

Which controller is active depends on the state of the Change-Over contact. (Factory default: contact open heating controller active, contact closed cooling controller active). The terminals 3 and 4 are used as outputs for heating resp. cooling.

Change-Over Sensor

The Change-Over Sensor is used for switching between heating and cooling mode automatically. If the temperature is below 19 ° C, the controller is in cooling mode. If it is above 28 ° C, it is a heating mode.

If an input is configured as a change-over, the room thermostat is automatically in 2-pipe operating mode and both outputs (terminals 3 and 4) are used as outputs for heating resp. cooling.

Window contact/Energy hold off

If a window contact is enabled via the digital input, the reference will switch to a setback set point (Heat SP/Cool SP).

Dewpoint

An active dewpoint contact locks the cooling controller.

Occupancy

If occupancy-function is active, the symbol will be displayed automatically. In state of “unoccupied” the heating set point is reduced by 2K (default setting) resp. the cooling set point raised by 2K.

Keycard-Switch

When the card is not inserted, the device is switched in sleep mode. Operation of the keys is locked, the display is switched off and the controller adjusts to the nominal values of the "unoccupied"-State.

Application notice

SD-Card

A Micro-SD card slot inside the device can be used to update a new firmware version or a new device configuration. With the PC configuration tool a configuration file with extended parameter set can be created and uploaded via SD card. Only SD cards formatted in the FAT file system can be used! NTFS and exFAT file systems are not supported.

Boot Loader

Because of an integrated bootloader a new application (update, upgrade) can be uploaded by means of a SD card. To insert the SD card, the upper part must be removed. If the boot loader is activated, the ring illumination blinks in a 1s cycle, while display is not triggered! After recognition of a SD card with a valid application the update process is started. Now, ring illumination blinks in a 300ms cycle. After a successful update process (Duration approx. 2-3 minutes!) the new application is started automatically. Afterwards, SD card shall be removed!



Software:

A detailed description of the parameter and the configuration software can be found using the following link.

→ [Download](#)

Dimensions (mm)

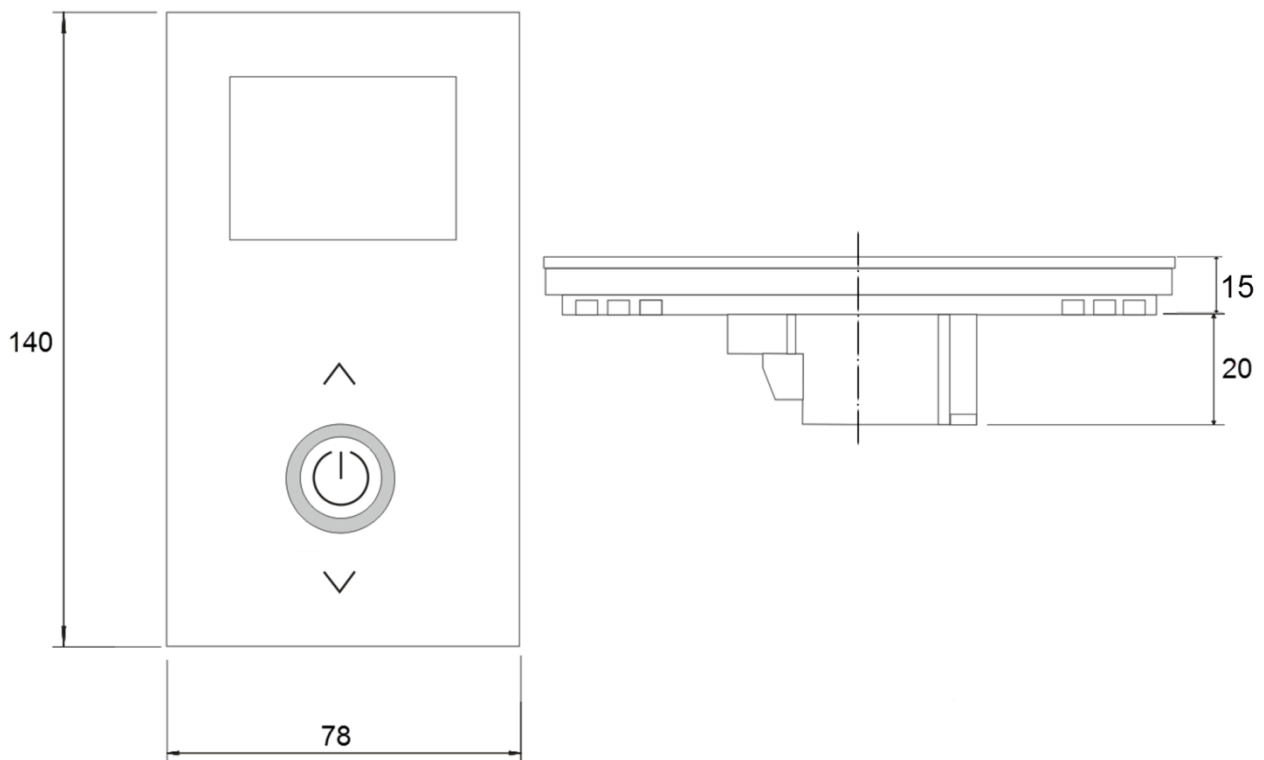

Accessories (optional)

Converter RS485 Modbus - USB

Item No. 668293