

INTRODUCTION

Thank you for choosing an HK Instruments DPT-MOD series differential pressure transmitter. The DPT-MOD series is intended for use in commercial environments. DPT-MOD is a multifunctional transmitter for measuring volume flow, velocity, and static and differential pressure. The measurements can be read and the configuration done via Modbus communication. DPT-MOD requires less wiring than the traditional 3-wire transmitters because multiple devices can be connected on serial line. DPT-MOD can also be used with several different measurement probes such as FloXact™ or pitot tube, and air dampers.

The DPT-MOD series is comprised of DPT-MOD-2500 and DPT-MOD-7000 with measurement ranges of -250...2500 Pa and -250...7000 Pa respectively. All models come with display and optional autozero calibration.

APPLICATIONS

DPT-MOD series devices are commonly used in HVAC/R systems for:

- fan, blower and filter monitoring
- pressure and flow monitoring
- valve and damper control
- pressure monitoring in cleanrooms
- air flow monitoring across centrifugal fans and blowers
- in-duct air flow or pressure monitoring
- measuring air flow or pressure in VAV applications

SPECIFICATIONS

Performance

Accuracy (at applied pressure):

Model 2500:

Pressure < 125 Pa = 1 % + ±2 Pa

Pressure > 125 Pa = 1 % + ±1 Pa

Model 7000:

Pressure < 125 Pa = 1.5 % + ±2 Pa

Pressure > 125 Pa = 1.5 % + ±1 Pa

(Accuracy specifications include: general accuracy, linearity, hysteresis, long term stability, and repetition error)

Thermal effects:

Temperature compensated 0...50 °C

Overpressure:

Proof pressure: 25 kPa

Burst pressure: 30 kPa

Zero point calibration:

Automatic autozero, manual pushbutton or via Modbus register

Response time:

1.0–20 s, selectable via menu or via Modbus register

Communication

Protocol: MODBUS over Serial Line

Transmission Mode: RTU

Interface: RS485

Byte format (11 bits) in RTU mode:

Coding System: 8-bit binary

Bits per Byte:

1 start bit

8 data bits, least significant bit sent first

1 stop bit

1 bit for parity

1 stop bit

Baud rate: selectable in configuration

Modbus address: 1–247 addresses selectable in configuration menu

Technical Specifications

Media compatibility:

Dry air or non-aggressive gases

Pressure units (select via menu):

Pa, kPa, mbar, inWC, mmWC

Flow units (select via menu):

Volume: m³/s, m³/hr, cfm, l/s

Velocity: m/s, ft/min

Measuring element:

MEMS, no flow-through

Environment:

Operating temperature: -20...50 °C,

with autozero (-AZ) calibration -5...50 °C

Storage temperature: -40...70 °C

Humidity: 0 to 95 % rH, non condensing

Physical

Dimensions:

Case: 90.0 x 95.0 x 36.0 mm

Weight:

150 g

Mounting:

2 each 4.3 mm screw holes, one slotted

Materials:

Case: ABS

Lid: PC

Duct connectors: ABS

Tubing: PVC

Protection standard:

IP54

Display

2-line display (12 characters/line)

Line 1: Volume or velocity measurement

Line 2: Pressure measurement

Size: 46.0 x 14.5 mm

WARNING

- READ THESE INSTRUCTIONS CAREFULLY BEFORE ATTEMPTING TO INSTALL, OPERATE OR SERVICE THIS DEVICE.
- Failure to observe safety information and comply with instructions can result in PERSONAL INJURY, DEATH AND/OR PROPERTY DAMAGE.
- To avoid electrical shock or damage to equipment, disconnect power before installing or servicing and use only wiring with insulation rated for full device operating voltage.
- To avoid potential fire and/or explosion do not use in potentially flammable or explosive atmospheres.
- Retain these instructions for future reference.
- This product, when installed, will be part of an engineered system whose specifications and performance characteristics are not designed or controlled by HK Instruments. Review applications and national and local codes to assure that the installation will be functional and safe. Use only experienced and knowledgeable technicians to install this device.

Electrical connections:

4-screw terminal block

Wire: 0.2–1.5 mm² (12–24 AWG)

Cable entry:

Strain relief: M16

Knockout : 16 mm

Pressure fittings

Male ø 5.0 mm and 6.3 mm

Electrical

Supply voltage:

24 VAC or VDC ± 10 %

Power consumption:

< 1.3 W

Output signal:

via Modbus

Conformance

Meets requirements for CE marking:

EMC Directive 2014/30/EU

RoHS Directive 2011/65/EU

WEEE Directive 2012/19/EU

COMPANY WITH
MANAGEMENT SYSTEM
CERTIFIED BY DNV GL
= ISO 9001 = ISO 14001 =



SCHEMATICS

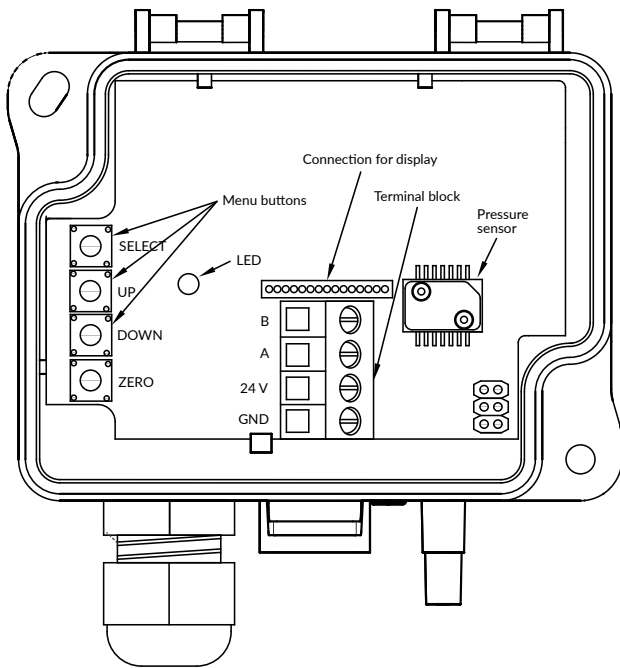

DIMENSIONAL DRAWINGS

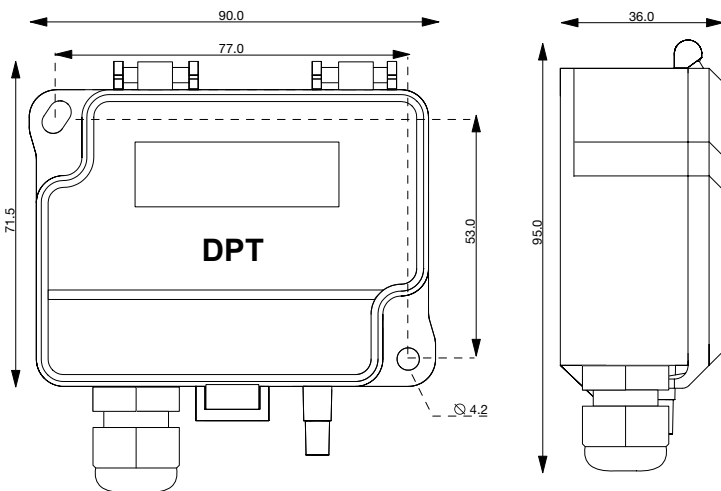

INSTALLATION

- 1) Mount the device in the desired location (see step 1).
- 2) Open the lid and route the cable through the strain relief and connect the wires to the terminal block(s) (see step 2).
- 3) The device is now ready for configuration.

⚠ WARNING! Apply power only after the device is properly wired.

STEP 1: MOUNTING THE DEVICE

- 1) Select the mounting location (duct, wall, panel).
- 2) Use the device as a template and mark the screw holes.
- 3) Mount with appropriate screws.

MOUNTING THE DEVICE CONTINUED

Figure 1a - Surface mounting

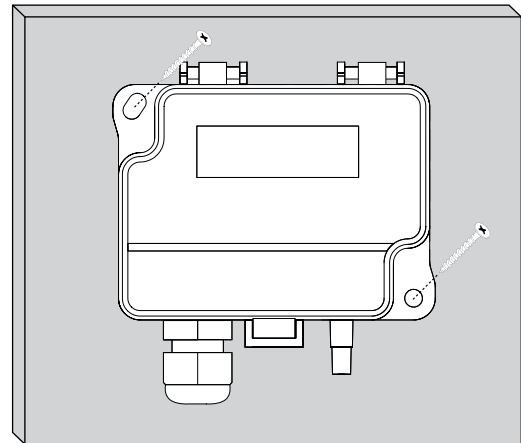

Figure 1b - Mounting orientation

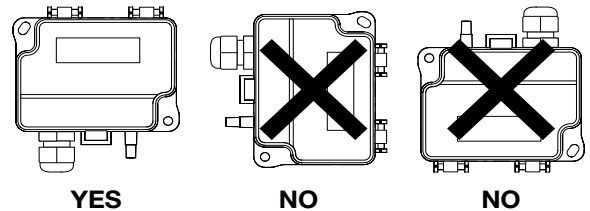
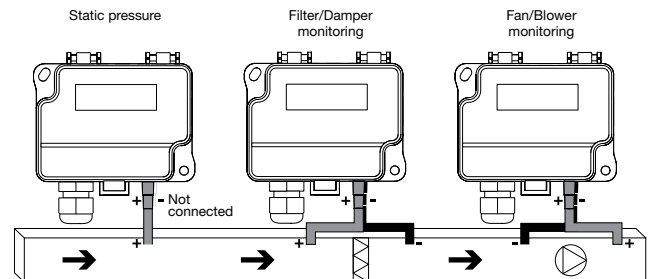

Figure 1c - Application connections

Pressure



Flow

The pressure tubes are connected to a flow measurement probe (i.e. FloXact), or to the measurement ports specified by the fan manufacturer. Please see the FloXact installation guide or the fan manufacturer's technical specifications for more information.

STEP 2: WIRING DIAGRAMS

For CE compliance, a properly grounded shielding cable is required.

- 1) Unscrew the strain relief and route the cable.
- 2) Connect the wires as shown in figure 2.
- 3) Tighten the strain relief.

Figure 2 - Wiring diagram

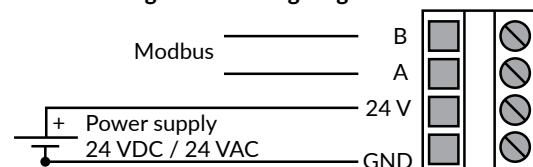

STEP 3: CONFIGURATION

NOTE: The flow unit *none* is selected by default and the display shows only the pressure reading.

1) Select the functioning mode of the flow meter:

- Select *Manufacturer* when connecting DPT-MOD to a fan with pressure measurement points
- Select *Common probe* when using DPT-MOD with a common measurement probe that follows the formula:
 $q = k \cdot \sqrt{\Delta P}$ (i.e. FloXact)

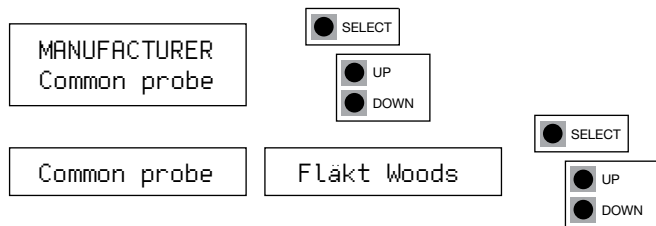

2) If *Common probe* selected: select measurement units used in the formula (aka Formula unit) (i.e. l/s)

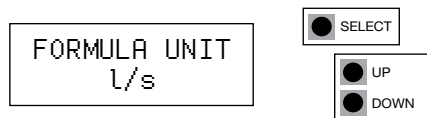

3) Select K-value

a. If manufacturer selected in step 1:

Each fan has a specific K-value. Select the K-value from fan manufacturer's specifications.

Manufacturer:	K-value:
Fläktwoods	k = 0,3...99
Rosenberg	k = 37...800
Nicotra	k = 10...1500
Comefri	k = 10...2000
Ziehl	k = 10...1500
Ebm-papst	k = 10...1500
Gebhardt	k = 50...4700

b. If *Common probe* selected in step 1:

Each common probe has a specific K-value. Select the K-value from common probe manufacturer's specifications.

Available K-value range: 0.001...9999.000.



4) Select pressure unit for display: Pa, kPa, mbar, inWC, mmWC or none.

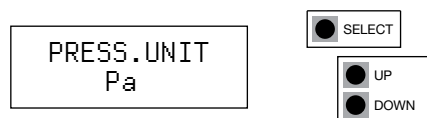

5) Select flow unit for display:

Flow volume: m³/s, m³/h, cfm, l/s, none (default)
 Velocity: m/s, f/min, none

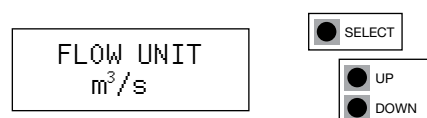

CONFIGURATION CONTINUED

6) Response time: Select response time between 1.0-20 s.

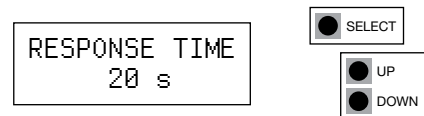

7) Select the address for Modbus: 1...247.

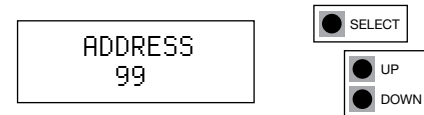

8) Select the baud rate: 9600/19200/38400.



9) Select the parity bit: None/Even/Odd.



10) Push select button to save changes and to exit menu.

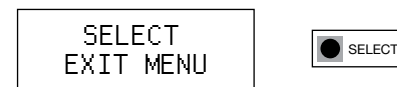

STEP 4: ZEROING THE DEVICE

NOTE! Always zero the device before use.

To zero the device three options are available:

- 1) Manual Pushbutton zero point calibration
- 2) Autozero calibration
- 3) Via Modbus register

Does my transmitter have an autozero calibration? See the product label. If it shows -AZ in the model number, then you have the autozero calibration.

1) Manual Pushbutton zero point calibration

NOTE: Supply voltage must be connected at least one hour prior to zero point adjustment.

- a) Disconnect both pressure tubes from the pressure ports labeled + and -.
- b) Push down the zero button until the LED light (red) turns on and the display reads "zeroing" (display option only). (see figure 3)
- c) The zeroing of the device will proceed automatically. Zeroing is complete when the LED turns off, and the display reads 0 (display option only).
- d) Reinstall the pressure tubes ensuring that the High pressure tube is connected to the port labeled +, and the Low pressure tube is connected to the port labeled -.

ZEROING THE DEVICE CONTINUED

Figure 3

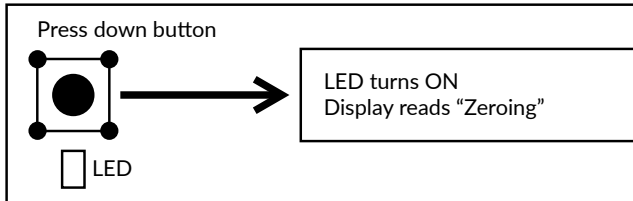

2) Autozero calibration

If the device includes the optional autozero circuit, no action is required.

Autozero calibration (-AZ) is an autozero function in the form of an automatic zeroing circuit built into the PCB board. The autozero calibration electronically adjusts the transmitter zero at predetermined time intervals (every 10 minutes). The function eliminates all output signal drift due to thermal, electronic or mechanical effects, as well as the need for technicians to remove high and low pressure tubes when performing initial or periodic transmitter zero point calibration. The autozero adjustment takes 4 seconds after which the device returns to its normal measuring mode. During the 4 second adjustment period, the output and display values will freeze to the latest measured value.

Transmitters equipped with the autozero calibration are virtually maintenance free.

3) Via Modbus register

Make sure there is no pressure in the duct when the zeroing is done via Modbus register.

STEP 5: MODBUS REGISTERS

Function code 04 - Read input register

Register	Parameter description	Data Type	Value	Range
3x0001	Program version	16 bit	0...9900	0,00...99,00
3x0002	Pressure reading	16 bit	-250...2500/7000	-250...2500/7000 Pa
3x0003	Flow m ³ /s	16 bit	0...10000	0...100 m ³ /s
3x0004	Flow m ³ /h	16 bit	0...30000	0...30000 m ³ /h
3x0005	Flow cfm	16 bit	0...30000	0...30000 cfm
3x0006	Flow l/s	16 bit	0...3000	0...3000 l/s
3x0007	Velocity m/s	16 bit	0...1000	0...100 m/s
3x0008	Velocity f/min	16 bit	0...5000	0...5000 f/min

Function code 05 - Write single coil

Register	Parameter description	Data Type	Value	Range
0x0001	Zero point calibration	Bit 0	0...1	On - Off

Function code 03 - Read input holding register

Register	Parameter description	Data Type	Value	Range
4x0001	Manufacturer	16 bit	0...7	0...7
4x0002	Formula unit (Manufacturer=7)	16 bit	0...5	0: m ³ /s, 1: m ³ /h, 2: cfm, 3: l/s, 4: m/s, 5: f/min
4x0003	K-factor integer	16 bit	0...9999	0...9999
4x0004	K-factor decimal	16 bit	0...999	0...999
4x0005	Response time	16 bit	1...20	1...20 s

MODBUS REGISTERS CONTINUED

Function code 06 - Write single register

Register	Parameter description	Data Type	Value	Range
4x0001	Manufacturer	16 bit	0...7	0...7
4x0002	Formula unit (Manufacturer=7)	16 bit	0...5	0: m ³ /s, 1: m ³ /h, 2: cfm, 3: l/s, 4: m/s, 5: f/min
4x0003	K-factor integer	16 bit	0...9999	0...9999
4x0004	K-factor decimal	16 bit	0...999	0...999
4x0005	Response time	16 bit	1...20	1...20 s

Function code 16 - Write multiple registers

Register	Parameter description	Data Type	Value	Range
4x0001	Manufacturer	16 bit	0...7	0...7
4x0002	Formula unit (Manufacturer=7)	16 bit	0...5	0: m ³ /s, 1: m ³ /h, 2: cfm, 3: l/s, 4: m/s, 5: f/min
4x0003	K-factor integer	16 bit	0...9999	0...9999
4x0004	K-factor decimal	16 bit	0...999	0...999
4x0005	Response time	16 bit	1...20	1...20 s

RECYCLING/DISPOSAL

The parts left over from installation should be recycled according to your local instructions. Decommissioned devices should be taken to a recycling site that specializes in electronic waste.



WARRANTY POLICY

The seller is obligated to provide a warranty of five years for the delivered goods regarding material and manufacturing. The warranty period is considered to start on the delivery date of the product. If a defect in raw materials or a production flaw is found, the seller is obligated, when the product is sent to the seller without delay or before expiration of the warranty, to amend the mistake at his/her discretion either by repairing the defective product or by delivering free of charge to the buyer a new flawless product and sending it to the buyer. Delivery costs for the repair under warranty will be paid by the buyer and the return costs by the seller. The warranty does not comprise damages caused by accident, lightning, flood or other natural phenomenon, normal wear and tear, improper or careless handling, abnormal use, overloading, improper storage, incorrect care or reconstruction, or changes and installation work not done by the seller or his/her authorized representative. The selection of materials for devices prone to corrosion is the buyer's responsibility, unless otherwise is legally agreed upon. Should the manufacturer alter the structure of the device, the seller is not obligated to make comparable changes to devices already purchased. Appealing for warranty requires that the buyer has correctly fulfilled his/her duties arisen from the delivery and stated in the contract. The seller will give a new warranty for goods that have been replaced or repaired within the warranty, however only to the expiration of the original product's warranty time. The warranty includes the repair of a defective part or device, or if needed, a new part or device, but not installation or exchange costs. Under no circumstance is the seller liable for damages compensation for indirect damage.