

PRODUCT CATALOGUE



HK Instruments 4
 Values, vision, mission 6
 OEM 7
 References 8
 Join our HK Instruments Family of Distributors 10
 Applications 12
 Accessories 96

PRODUCT PORTFOLIO

DIFFERENTIAL PRESSURE TRANSMITTERS

DPT-R8 8-range differential pressure transmitter . 20
DPT-PRIMA High accuracy differential pressure transmitter22
DPT-MOD Differential pressure transmitter with air flow measurement and Modbus communication 24
DPT-IO-MOD Differential pressure transmitter with Input terminal and Modbus communication26
DPT-DUAL-MOD Differential pressure transmitter with two pressure sensors and Modbus communication 28
DPT-DUAL Differential pressure transmitter with two pressure sensors30
DPT-2W Differential pressure transmitter with 2-wire configuration 32
DPI Electronic differential pressure switch and transmitter 34



AIR FLOW AND VELOCITY TRANSMITTERS

DPT-FLOW FLOXACT™ Flow transmitter for HVAC systems 40
 Averaging multi-point pitot tube for flow measurements. 42
DPT-FLOW-BATT Battery powered differential pressure and air flow meter 44
AVT Air velocity and temperature transmitter with relay output. 46



PRESSURE AND FLOW CONTROLLERS

DPT-CTRL PID controllers with differential pressure or air flow transmitter50
DPT-CTRL-MOD PID controllers with differential pressure or air flow transmitter and Modbus communication52



CARBON DIOXIDE TRANSMITTERS

CDT2000 Wall mount CO₂ and temperature transmitter56
CDT-MOD-2000 Wall mount CO₂ and temperature transmitter with Modbus communication ..56
CDT2000 DUCT CO₂ and temperature transmitter for duct . 58
CDT-MOD-2000 DUCT CO₂ temperature transmitter for duct with Modbus communication58



HUMIDITY TRANSMITTERS

RHT Wall mount humidity (rH) and temperature transmitter62
RHT-MOD Wall mount humidity (rH) and temperature transmitter with Modbus communication62
RHT DUCT Humidity (rH) and temperature transmitter for duct64
RHT-MOD DUCT Humidity (rH) and temperature transmitter for duct with Modbus communication64



INDOOR AIR QUALITY

SIRO Indoor air quality transmitter 68
SIRO-MOD Indoor air quality transmitter with Modbus communication. 70
CMT Carbon monoxide transmitter72



PRESSURE TRANSMITTERS FOR LIQUIDS

PTL-HEAT Pressure transmitter for liquids in heating systems 74
PTL-COOL Pressure transmitter for liquids in cooling systems 74
DPTL Differential pressure transmitter for liquids. 74



PASSIVE TEMPERATURE SENSORS

PTE-DUCT Duct temperature sensor 78
PTE-ROOM Room temperature sensor 78
PTE-CABLE Cable temperature sensor 78
PTE-O/OI Outside air temperature/illuminance sensor. 80
PTE-I Immersion sensor 82
PTE-FI Fast response immersion sensor 82
PTE-SF Surface sensor 84
PTE-FG Frost guard sensor 84



AIR PRESSURE GAUGES & MANOMETERS

DPG Differential pressure gauge 86
MM Liquid column manometer with leakage protection system.88
MMU U-tube manometer88
YM-3 Overpressure meter for shelters 90

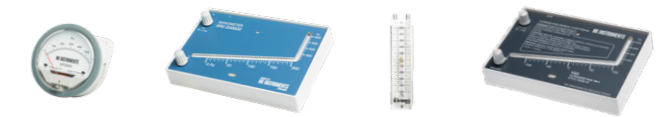

PRESSURE SWITCHES

PS Mechanical differential pressure switch92



FILTER ALERTS (DISPLAY + RELAY)

MM/PS Combination of liquid column manometer and differential pressure switch 94
DPG/PS Combination of differential pressure gauge and differential pressure switch94



MICROMANOMETER

PHM-V1 Handheld micromanometer for measuring air pressure and air flow. 96



HIGH-QUALITY MEASURING DEVICES FOR CLEAN INDOOR AIR

HK Instruments is a family-owned Finnish company that helps its customers to keep the quality of indoor air and the functionality of buildings high, resulting in wellbeing and energy savings. We design highly accurate and easy to-use measuring devices for HVAC applications in ventilation and building automation systems.

Having lived in the clean Finnish climate, we know what it is like to breathe in good-quality fresh air. This is why we have been leading the way, in Finland and abroad, for more than 30 years, allowing everyone to enjoy good-quality indoor air.

Our advanced measuring devices produce highly accurate real-time information about indoor air to the building management system. This leads to high functionality of the building, which supports the wellbeing of people while keeping energy costs down. Our products are known for their ease of use. Applications for our devices range from highly demanding laboratory conditions to regular residential buildings.

We understand that there are different needs in different parts of the world and in different applications. This is why we work with you to customize our solutions for your needs. Using the information our devices produce, we help you to make smart decisions to support the wellbeing of your people and the functionality of your building. Our decades of experience and our broad product range allow us to offer our services to market areas at highly different levels of development.

WE SPEND NEARLY 90 % OF OUR TIME INDOORS. THE QUALITY OF INDOOR AIR IS NOT INSIGNIFICANT. CLEAN INDOOR AIR THAT MAINTAINS WELLBEING IS ONE OF THE PRECONDITIONS FOR LIFE. THE CORRECT KIND OF INDOOR AIR MAINTAINS HEALTH, ENERGY LEVELS AND COMFORT. GOOD INDOOR AIR QUALITY SAVES COSTS IN HEALTHCARE AND BUILDING MAINTENANCE.



VALUES

FAMILY | FRIENDSHIP | BASIC NEEDS OF PEOPLE

We respect Family and Friendship. Every person sharing our journey is welcomed to our HK Instruments Family. We care about people's wellbeing – including their right to breathe clean air.



VISION

To deliver the best user and customer experience in HVAC and building automation.



MISSION

Our mission is to provide clean indoor air and energy savings by manufacturing user-friendly measuring devices for HVAC.

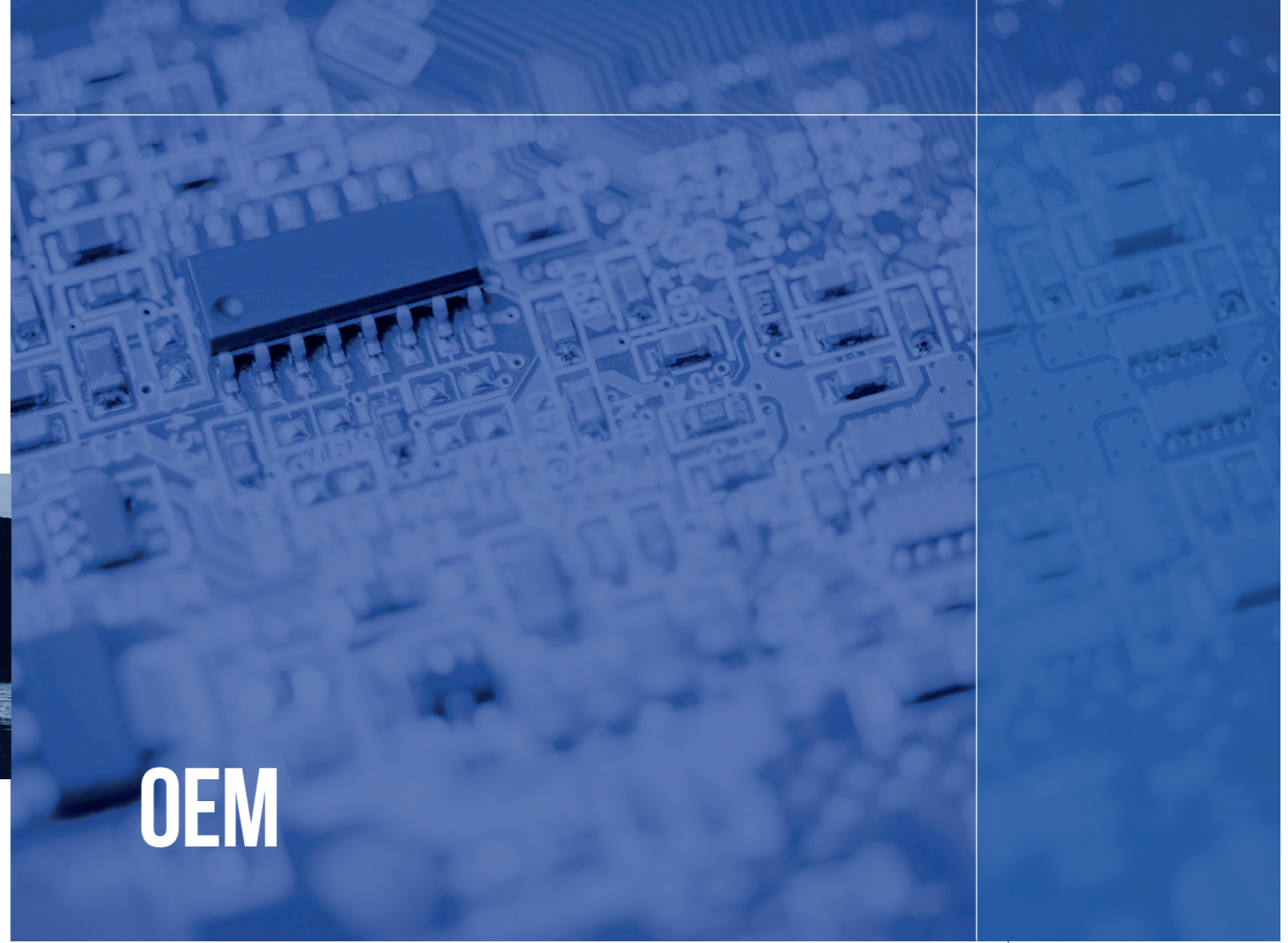

OEM

Many of our customers are OEMs, in particular companies manufacturing air handling units. They need solutions tailored to their individual needs. We excel at unique, customer-focused implementations.

HK Instruments has cooperated closely with OEMs for more than 30 years. We have gained broad and varied experience in unique device solutions, and we have always found a functional solution for the customer's specific needs. Our expert team is attuned to your needs and knows how to meet them. We stand out from the competition by being flexible and efficient. We stay on schedule and within budget – while also listening to our customer's needs at all times. Our OEM customers are actively involved throughout the manufacturing process, as we are convinced that continuous interaction produces the best results.

We are always open to new challenges and opportunities and would like to hear from you. We will find a solution that meets your and your company's needs.

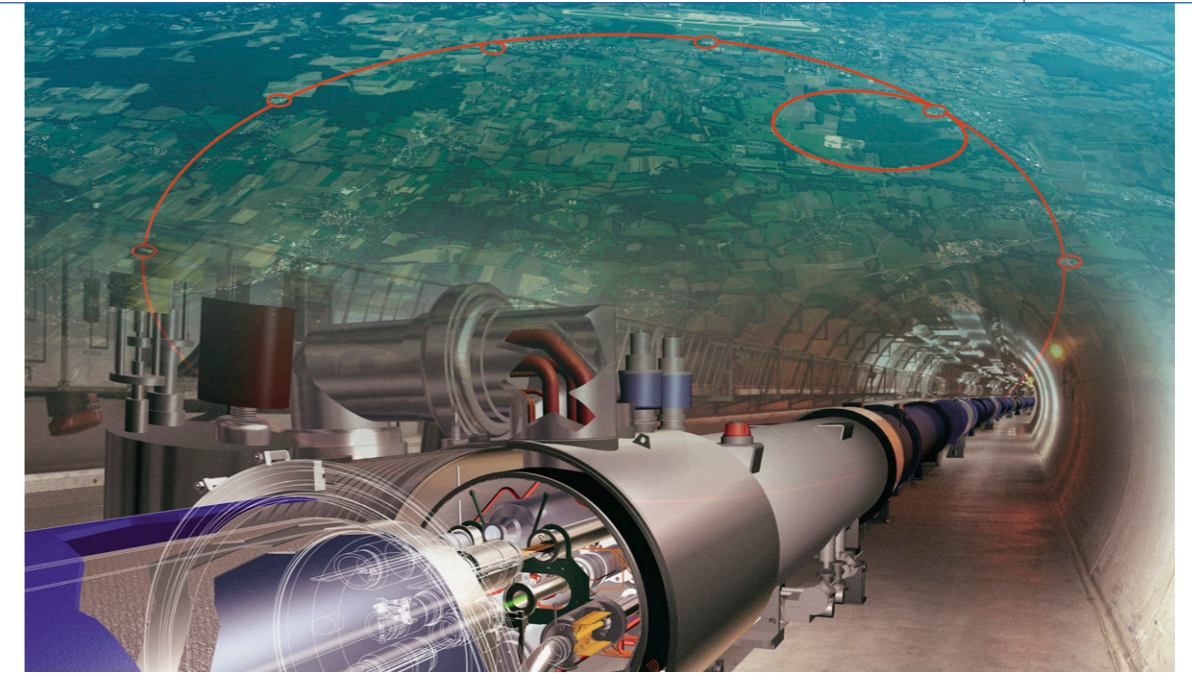

Image: CERN

OUR PARTNER IN INDIA

Parshvi Technology is HK Instruments' exclusive distributor partner in India. We are a family-run, medium-sized and financially independent company. We offer reliable, high-quality products for process applications. We work closely with our customers to understand their process applications and to offer the right products that make them happy. We have successfully worked together with HK Instruments for the last three years and are supplying the demanding Indian market with products of outstanding quality and beautiful design. Our success is based on products and services that offer our business partners added value.

Parshvi Technology is one of the leading companies within the industry in India. India's HVAC and lighting requirements, customer priorities, market adoption rate, and as a result, market realities, are very different from the rest of the world. That said, there are four key trends that are the most evident in the Indian commercial buildings segment - increasing automation across commercial spaces, increasing awareness of the need for energy efficiency, customers becoming more demanding in terms of comfort and indoor air quality, and lastly, new technologies making all these benefits available at a price point affordable to most.

HK Instruments is specialized in producing high-quality measuring devices for clean indoor air. We have associated with HK instruments to offer high-quality products made in Finland to Indian customers who are always looking for reliable products with a competitive price level. HK Instruments is known for their user-friendly devices. Indian customers especially appreciate the differential pressure transmitter with 8 selectable measuring ranges, Modbus configuration and pressure unit selection. In addition, the DPT-Flow is much appreciated by customers for its easy configuration and high accuracy in measurement.

Parshvi feels that our cooperation with HK Instruments is based on mutual trust and having a common goal. Parshvi always wants to make the customer happy and to build a long business partnership.

Ramnarayan Ajmera
 Manager
 Parshvi Technology (India) PVT LTD

“PARSHVI FEELS THAT OUR COOPERATION WITH HK INSTRUMENTS IS BASED ON MUTUAL TRUST AND HAVING A COMMON GOAL.”

HK INSTRUMENTS EXPERTISE IN CERN

CERN, the European Laboratory for Particle Physics, is carrying out a large project to monitor and regulate the air conditioning inside the LHC (Large Hadron Collider), the particle accelerator that led to the discovery of the Higgs Boson. For the differential pressure measurements, CERN has selected the DPT250-R8 sensor from HK Instruments to meet the Organization's stringent requirements in terms of accuracy, reliability and ease of integration. A total of 50 DPT transmitters have been installed in the underground areas such as experimental caverns, across galleries and pressurized modules. In addition, air quality transmitters of type CDT2000 are used for the control of air conditioning in control rooms of the LHC experiments.

CERN HAS SELECTED THE DPT250-R8 SENSOR FROM HK INSTRUMENTS TO MEET THE ORGANIZATION'S STRINGENT REQUIREMENTS IN TERMS OF ACCURACY.

JOIN OUR HK INSTRUMENTS FAMILY OF DISTRIBUTORS

We are constantly looking for new distributors to join our HK Instruments family. Our distributors are long-term partners, and we put in work to nurture a relationship built on trust, service and true friendship. In our 30 years' experience, this has been the key to our company's steady growth and strength. Through our success, we've been able to continually develop and create outstanding products for HVAC and building automation.

1. SALES SUPPORT

We will provide you with an HK Instruments account manager dedicated to assist you with any questions you may have, for example choosing the suitable products for your customers.

2. LEAD GENERATION

We understand the importance of more leads for your business to grow. We are skilled in developing a sales pipeline and will offer you valuable leads to utilize in networking and sales.

3. MARKETING SUPPORT

Building your brand equity will help us both win. HK Instruments is a well-known and trusted brand in Europe, and we are generous in sharing our brand equity with your business. You will receive access to our extensive

media library, where you will find all marketing support materials ready to use. This includes catalogues in several languages, posters, photos, images, presentations etc.

4. TECHNICAL SUPPORT

We guarantee friendly and professional technical support between the hours of 8 a.m. and 4 p.m. GMT+2. We are here to help you.

5. FREE SALES AND TECHNICAL TRAINING

We offer our distributors sales and technical training free of charge. In some cases, we can provide you with personal technical training in Finland or in your premises. Contact your personal account manager for more information.

6. NFR SAMPLES

We are happy to send you Not for Resale (NFR) samples of HK Instruments products for use in testing, demonstrations and training.

7. SHARING BEST PRACTICES

We encourage you to share your success stories and feedback with our community. Connect with us and your fellow HK Instrument partners around the world.

8. PAYMENT TERMS

In some cases, we can offer you exclusive longer payment terms. We will always evaluate these cases individually and offer these terms solely to companies of solid credit standing and financial strength.

9. IMMEDIATE REPLACEMENT

In some cases, we offer immediate replacement of the products for our long standing partners, within our 5-year warranty period. No waiting for repair – instead, you will be instantly sent a fully functional product after sending us the defective piece.

10. PROJECT PRICING OPTION

When you are competing against a strong offer from a competitor for a substantial project, you can always ask for a project price.

MOST IMPORTANTLY, WE OFFER PRODUCTS THAT SELL.

In the HVAC and building automation industry, HK Instruments is known for:

- constant product development efforts to meet the highest standards of the HVAC industry
- competitive pricing and high quality products
- high-end Finnish design and quality

- 5-year warranty
- customized OEM products and private labeling
- its strong Nordic brand that is trusted globally by a wide scope of OEMs, system integrators, distributors and well-know multinational corporations
- more than 30 years of experience in manufacturing measuring devices for HVAC and building automation.

Contact our export sales managers for a chat and let's discuss more opportunities!

APPLICATIONS

AIR HANDLING UNITS (AHU) — MEASUREMENTS AND CONTROLS

TRADITIONAL SOLUTION

Air handling units are used in nearly all new and renovated buildings to ensure high-quality indoor air. In addition to providing clean indoor air, HK Instruments' easy-to-use devices enable cost-efficiency and effortless installation and monitoring of air handling units. In comparison with analogue devices, modern Modbus devices require less wiring, which reduces the cost of cabling work. Designed specifically for AHUs, the DPT-Dual-MOD-AHU combination is the only one of its kind on the market.

DPT-Flow (1) enables accurate air volume flow adjustment and control for supply and extracted air. DPT-R8 (3,5) monitors filter cleanliness and frosting in the heat recovery unit. The CDT (4), RHT (8) and PTE (2,6,7) sensors ensure demand-controlled ventilation.

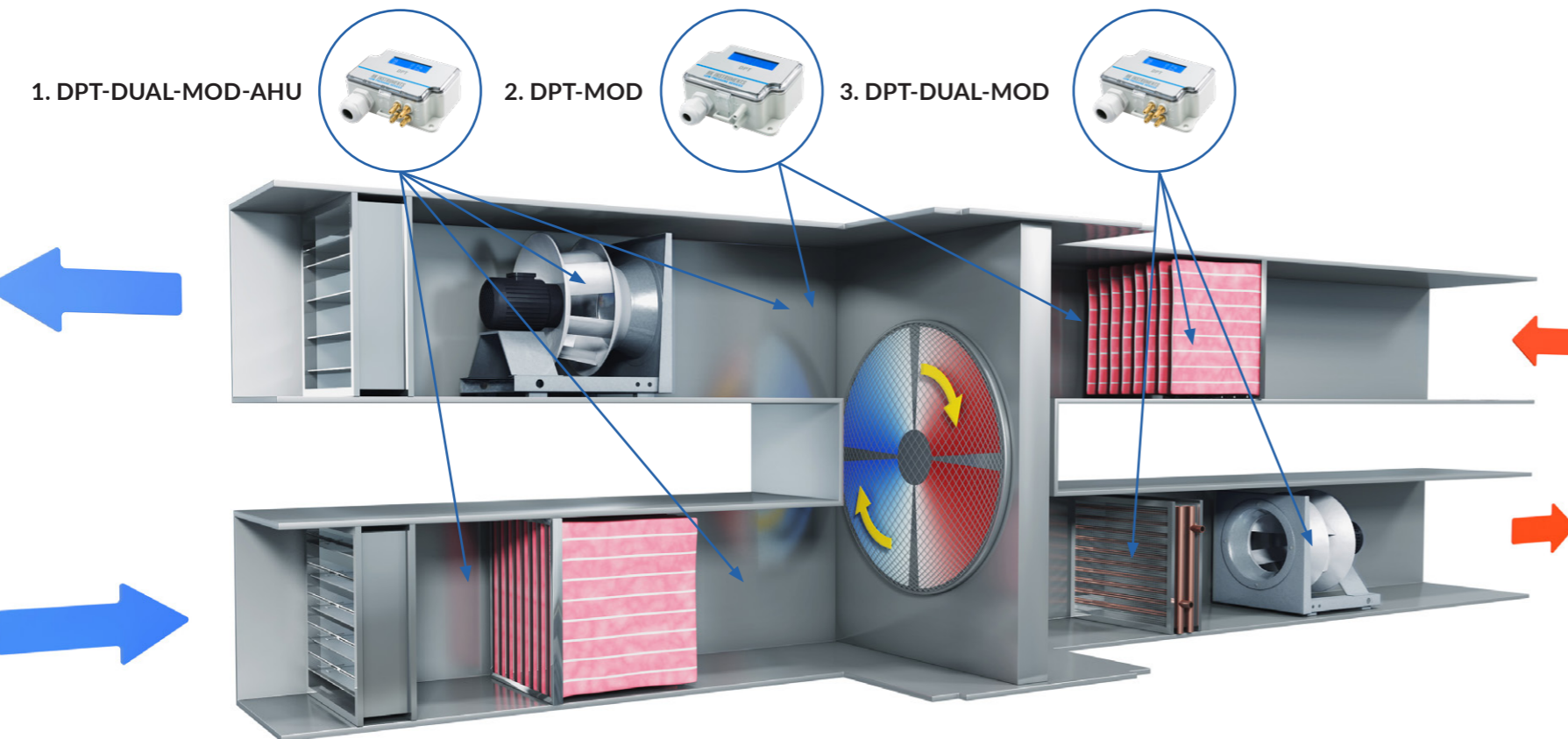
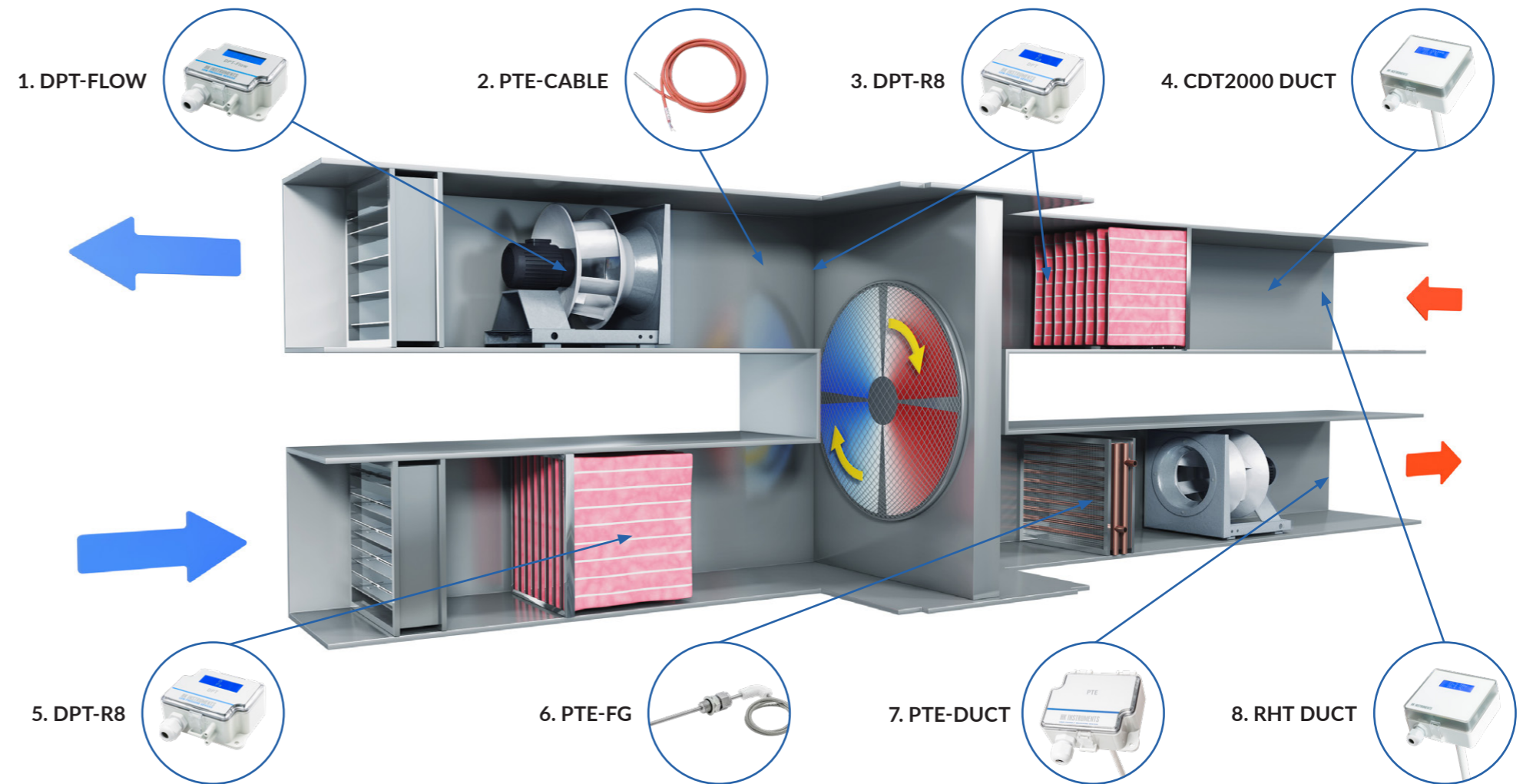

MODBUS SOLUTION

Our main products are also available with Modbus communication. When using a bus solution, you need less wires in cables and fewer input points in the controller. As a result, you will save in costs of the devices and installation.

DPT-Dual-MOD combines two differential pressure transmitters into one device. When using the Input terminal, temperature transmitters can be replaced with temperature sensors. This makes it possible to measure four different types of data.

With the Modbus solution, you only need 4 wires as opposed to 23 wires when using the traditional solution.

In the Modbus solution, DPT-Dual-MOD-AHU (1) monitors and controls air volumes. It also functions as a filter alert, replacing two separate measuring devices: air flow transmitter and differential pressure transmitter. DPT-Dual-MOD (3) is the right choice when you want to monitor and control duct pressure instead of air volumes. Two temperature sensors are connected to both DPT-Dual-MOD models. These sensors are essential for the functioning of the air handling unit. DPT-MOD (2) prevents frosting in the heat recovery unit.



ROOF EXTRACTION UNIT

In apartment buildings, roof extraction units are often necessary to ensure clean, high-quality indoor air. Ventilation in apartment buildings is often set at a default level, even though the load varies. This results in a significant loss of energy. Ventilation applications in apartment buildings are easy to implement by using HK Instruments' measurement devices. Our cost-efficient solutions do not necessarily need to be supported by an expensive building automation system.

DPT-Ctrl-MOD (2) keeps the air volume in the laundry facility at the desired standard value by controlling the EC exhaust fan. RHT-1R (1) monitors the air humidity and causes DPT-Ctrl-MOD to increase capacity when the air humidity increases. Siro-VOC-rH (3) and CDT-MOD-2000-DC-1R (5) monitor the air quality in apartments, and DPT-Ctrl-MOD (4) actively adjusts the exhaust fan. When the time extension mode of the CDT-MOD-2000-DC-1R is activated, the DPT-Ctrl-MOD receives the information via its binary input and boosts ventilation. CDT2000 and DPT devices communicate seamlessly with the building management system through the Modbus interface.

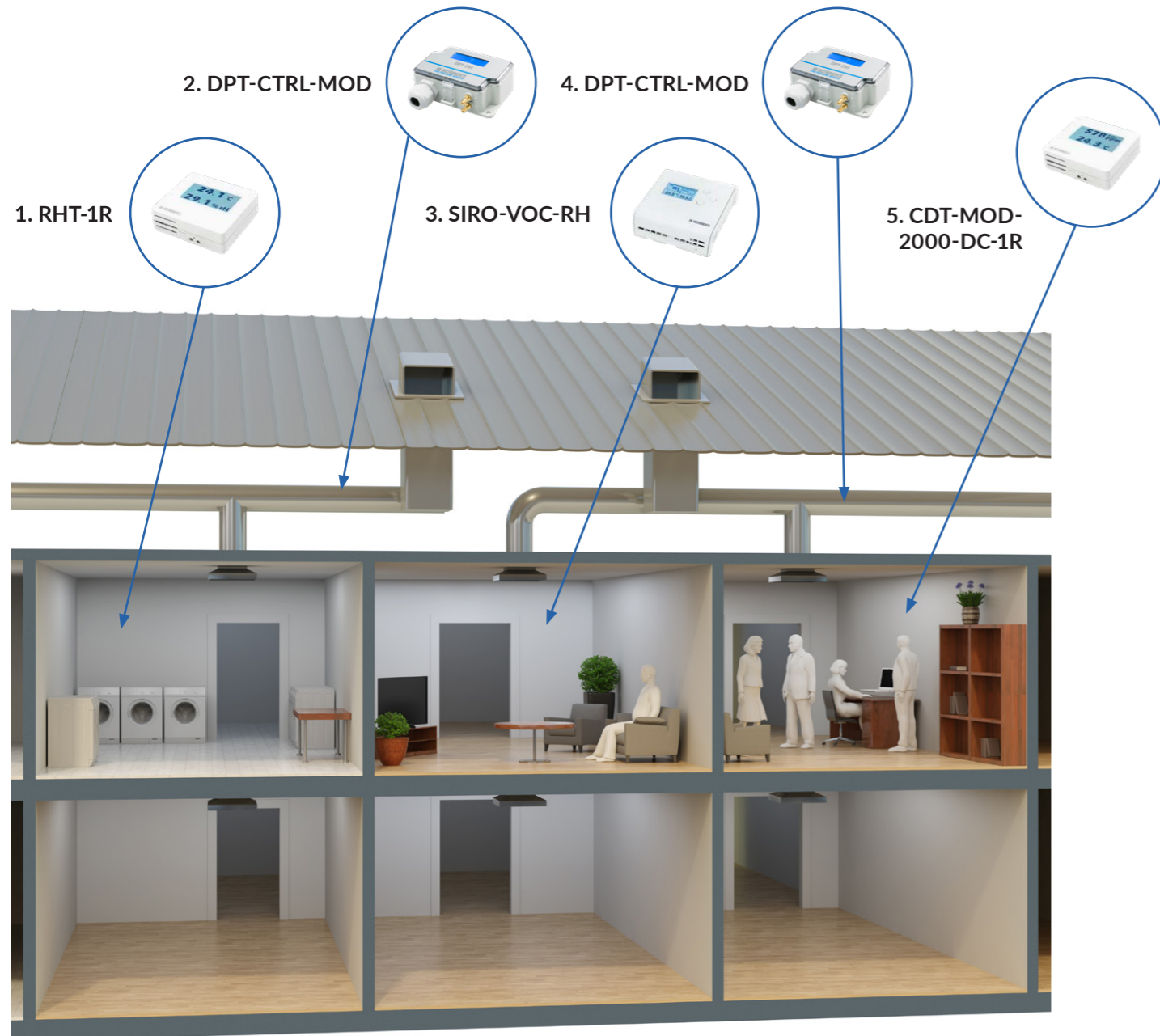

DEMAND-CONTROLLED VENTILATION (DCV)

HK Instruments' multifunctional measuring devices are used as a part of demand-controlled ventilation. Ventilation is boosted when a large number of people are in the building. Ventilation solutions of this type are needed in schools, offices, sports halls and hotels – that is, in all locations where it is important to maintain good air quality, even if utilisation rates vary greatly. In addition to ensuring good air quality, demand-controlled ventilation reduces energy consumption in buildings.

As a result of technical innovations, our devices are even more versatile than before. CDT2000-DC, a CO₂ transmitter using Dual Channel technology, is maintenance-free and can also be used in hospitals, nursing homes and other environments that would be challenging for ordinary CO₂ transmitters. The large display on a CDT device is informative and easy to read, which also creates added value for the users of the building.

Siro-rH (1) and CDT2000 (3) monitor the air quality in individual rooms and communicate any needs for added capacity to the building management system. CDT2000 Duct (2) monitors the extracted air across the area, enabling demand-controlled ventilation in the entire office.

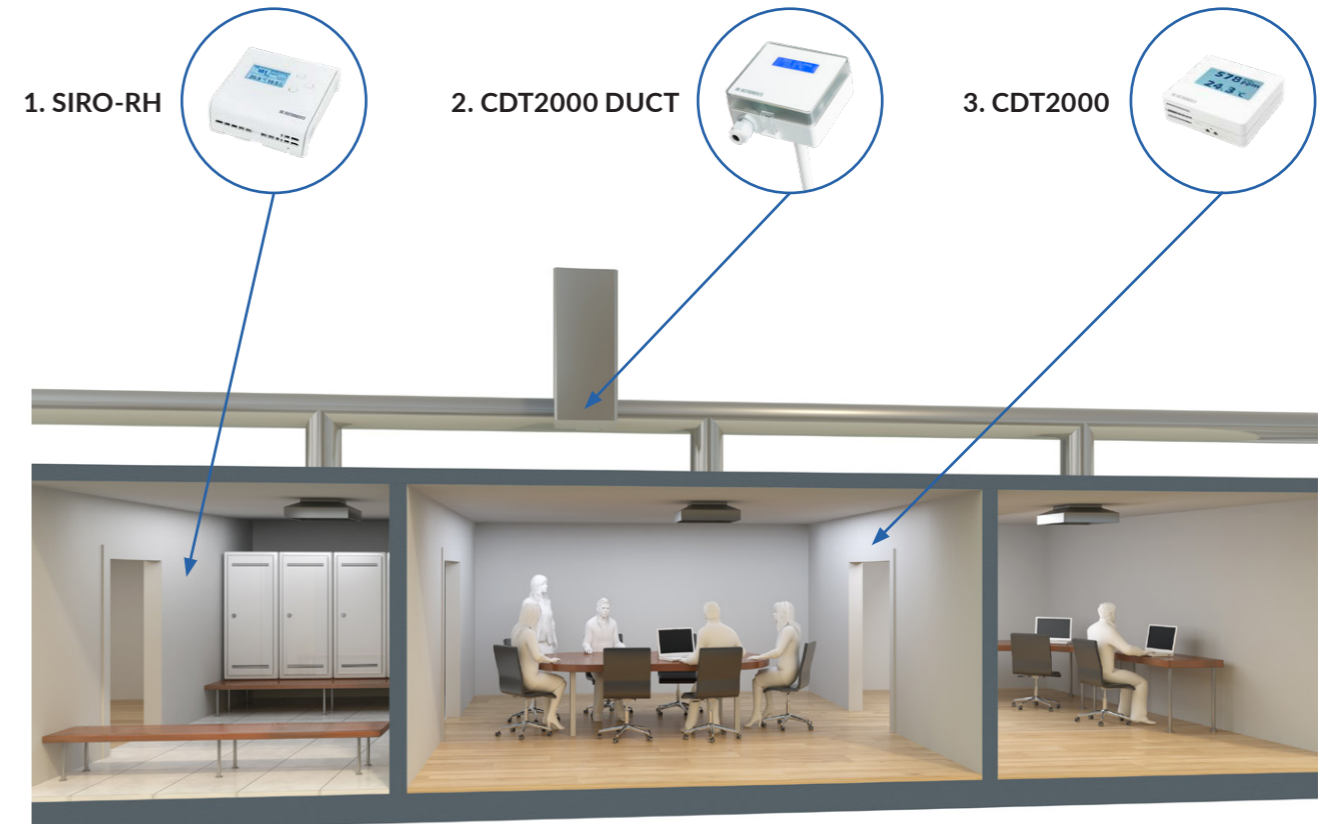

COMMERCIAL BUILDING SOLUTIONS

HK Instruments produces user-friendly measurement devices for indoor and outdoor facilities. Passive outdoor temperature and light sensors are reliable in use and reduce the need for cabling. These sensors predict the need for heating in a building and control outdoor lighting sensibly and energy-efficiently. Liquid pressure transmitters can be used to monitor district heating and cooling, as well as detecting any leaks and preventing water damage. Surveillance of differential pressure across the building envelope takes care of the health of the building and prevents serious structural problems.

PTE-OI (5) measures outdoor temperatures and the level of outdoor light. Together with PTE-Room (3), which measures room temperatures, and PTE-I (1), which measures heating system temperatures, the sensors enable the proactive control of the heating network. PTL-Heat (2) monitors pressure in the heating network and provides alerts about leaks when pressure decreases. PTE-OI carries out light measurements to determine when outdoor lighting should be switched on and off. DPT-Priima (4) measures the differential pressure over building envelope, maintaining the desired pressure balance. SPP (6), static pressure port, connected to DPT-Priima, prevents direct wind interference on the transmitter by filtering any wind gusts.

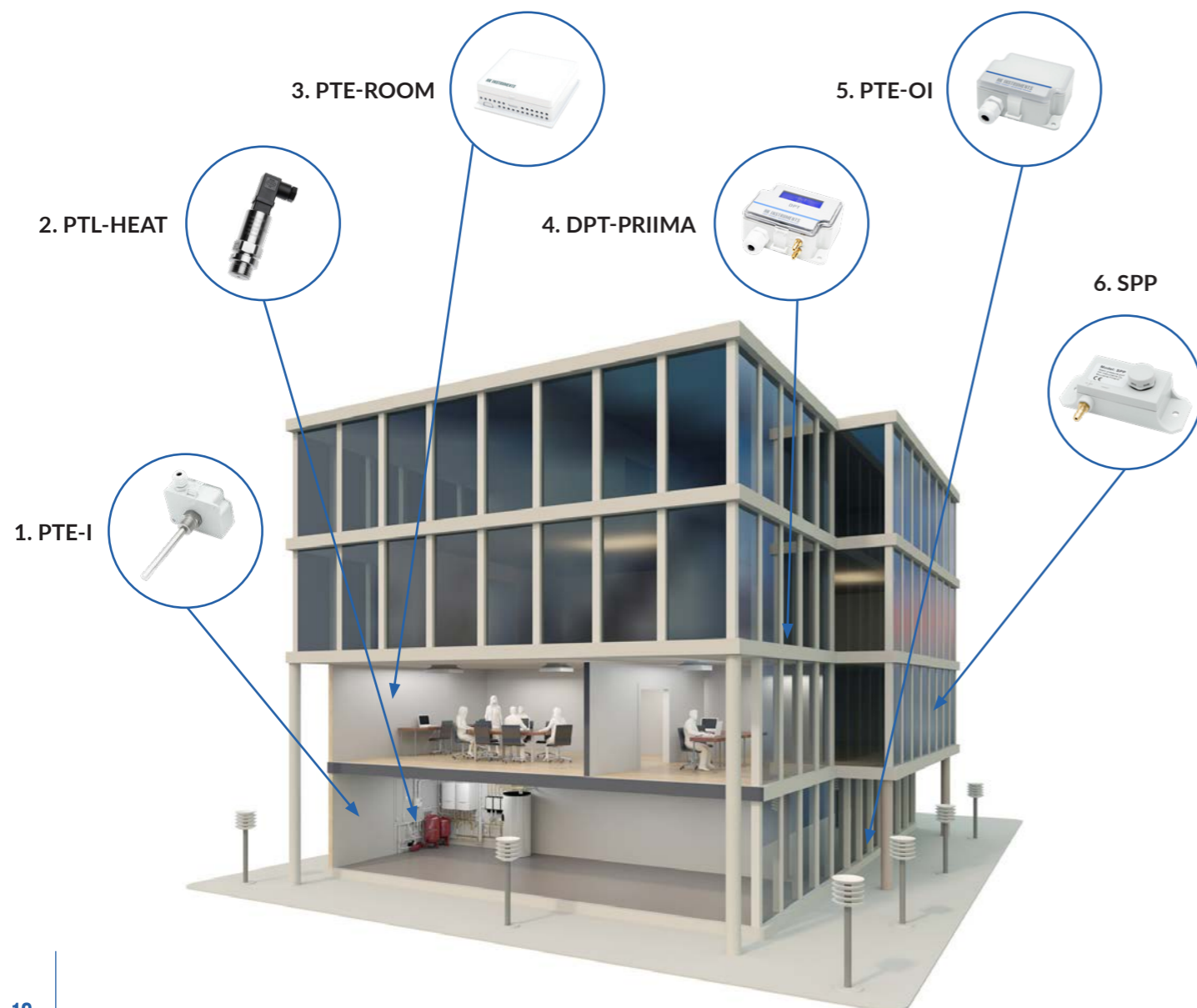

CLEANROOM APPLICATION

Pressure differences between rooms in hospitals, laboratories and other demanding environments can be controlled through pressurisation and depressurisation to ensure favourable working conditions and the cleanliness of products. Designed to monitor pressure differences between rooms, differential pressure transmitters measure the difference in pressure between the cleanroom and the outdoor air. DPT-Priima-AZ-D-S, which measures even the smallest pressure differences, is an excellent choice when the pressurisation of facilities requires high accuracy and operational reliability. In addition to measuring pressure differences, it is important to measure the temperature and humidity in cleanrooms. The RHT humidity and temperature transmitter is the perfect choice for such measurements. All our cleanroom devices include field calibration and are available with a calibration certificate. Our devices ensure uninterrupted production in cleanrooms, which require reliable, continuous monitoring.

The DPT-Priima-AZ-D-S (1) high-accuracy differential pressure transmitter monitors overpressure in laboratory facilities. The relay of the DPI±500-2R-AZ (2) electronic differential pressure switch and transmitter activates the beacon alarm light if the pressure in the facility exceeds the threshold value. Siro-rH (3) communicates the room temperature and humidity to the automation system. The DPG analogue gauge (4) is easy to read, which makes it suitable for indicating the exact pressure in the laminar flow cabinet. PTE-Cable (5) measures the temperature in a refrigerated cabinet, making it possible to collect long-term historical data.

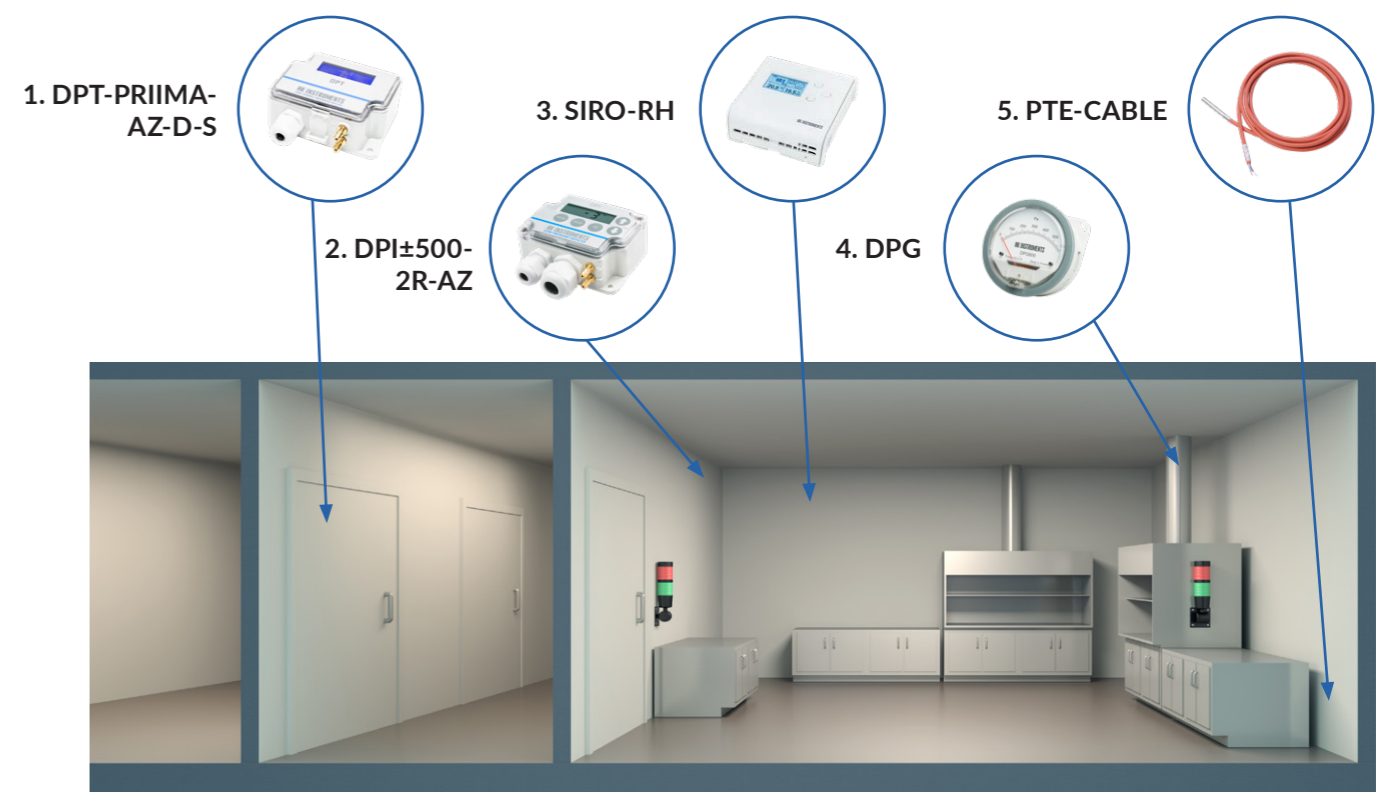

DIFFERENTIAL PRESSURE TRANSMITTERS

DPT series pressure transmitters are accurate and user-friendly devices with a stylish and modern design. Fully automated zero point calibration, AZ-calibration, offers reliability in the most sensitive of applications. In addition, the AZ-calibration provides cost savings over the lifetime of a building, as it makes the device completely maintenance-free.

The excellent usability of DPT-R8 series is widely known among electricians and installers all over the world. DPT-Priima is designed especially for high accuracy applications. DPT-MOD and DPT-IO-MOD series Modbus transmitters can be connected on serial line and therefore require less wiring than traditional transmitters. Modbus communication is a modern and distortion-free way to transmit measurement data.

The DPT-Dual-MOD with Modbus communication offers savings in the device and installation costs due to its two pressure sensors and Input terminal.



DPT-R8



DPT-PRIIMA



DPT-MOD



DPT-IO-MOD



DPT-DUAL-MOD



DPT-DUAL



DPT-2W



DPI

DPT-R8 DIFFERENTIAL PRESSURE TRANSMITTERS

THREE-WIRE

USER-FRIENDLY
DEVICES WITH AN
EXCEPTIONAL DESIGN



DPT-R8

The DPT-R8 series includes electronic differential pressure transmitters that offer exceptional performance, high quality and competitive pricing. Because of the high accuracy of the devices, it is usually not necessary to narrow down the range to get accurate measurements. DPT-R8 devices are easily customizable, and also available for private labeling.

USAGE & APPLICATIONS

The differential pressure transmitter is used for measuring low pressures of air and non-combustible gases in order to monitor and control building automation, HVAC and cleanroom systems.

OPTIONS

AZ: autozero element D: display S: span point calibration for high accuracy applications

-40C: cold-resistant model

TECHNICAL DETAILS

Accuracy (from applied pressure): (models 250 and 2500)	Pressure < 125 Pa = 1 % + ±2 Pa Pressure > 125 Pa = 1 % + ±1 Pa
Accuracy (from applied pressure): (model 7000)	Pressure < 125 Pa = 1.5 % + ±2 Pa Pressure > 125 Pa = 1.5 % + ±1 Pa
Zero point calibration:	automatic with autozero element (-AZ) or by pushbutton
Measuring units:	Pa, kPa, mbar, inchWC, mmWC, psi
Supply voltage:	24 VDC ±10 % / 24 VAC ±10 %
Power consumption:	< 1.0 W (< 1.2 W with output current 20 mA) -40 °C model: <4.0 W when <0 °C
Output signals (3-wire):	0...10 VDC 4...20 mA
Operating temperature:	-20...+50 °C (with autozero calibration -5...+50 °C) -40...+50 °C (-40C model)
Response time:	0.8 / 8 s
Protection standard:	IP54

DPT-R8

Example: DPT2500-R8-AZ-D	Product series					
	DPT	Differential pressure transmitter				
	Measuring ranges (Pa)					
	250	-150...+150 / -100...+100 / -50...+50 / -25...+25 / 0...25 / 0...50 / 0...100 / 0...250				
	2500	-100...+100 / 0...100 / 0...250 / 0...500 / 0...1000 / 0...1500 / 0...2000 / 0...2500				
	7000	0...1000 / 0...1500 / 0...2000 / 0...2500 / 0...3000 / 0...4000 / 0...5000 / 0...7000				
	Model type					
	-R8	Eight measuring ranges				
	Zero point calibration					
	-AZ	With autozero calibration Standard with pushbutton manual zero point calibration				
Display						
-D	With display Without display					
Span point calibration						
-S	Span point calibration Without span point calibration					
Cold resistance						
-40C	-40 °C cold resistant (not available with autozero calibration) Without -40 °C cold resistance					
Model	DPT	2500	-R8	-AZ	-D	

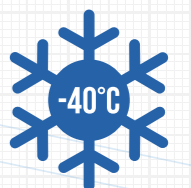

DPT-PRIIMA DIFFERENTIAL PRESSURE TRANSMITTERS

HIGH ACCURACY

HIGH ACCURACY
TRANSMITTER FOR
DEMANDING APPLICATIONS



TECHNICAL DETAILS

Accuracy (from applied pressure):	0.4 % + ±0.4 Pa
Measuring ranges (Pa):	-25...+25 / -50...+50 / -100...+100 / -500...+500 / 0...25 / 0...50 / 0...250 / 0...1000
Zero point calibration:	automatic with autozero element (-AZ) or by pushbutton
Measuring units:	Pa, kPa, mbar, inchWC, mmWC, psi
Supply voltage:	24 VDC ±10 % / 24 VAC ±10 %
Power consumption:	< 1.0 W (< 1.2 W with output current 20 mA)
Output signals (3-wire):	0...10 VDC 4...20 mA
Operating temperature:	-5...+50 °C
Response time:	0.4 / 8 s
Protection standard:	IP54

DPT-PRIIMA

Example: DPT-Priima-AZ-D-S	Product series				
	DPT	Differential pressure transmitter			
	Model type				
	-Priima	High accuracy			
	Zero point calibration				
	-AZ	With autozero calibration			
	Display				
	-D	With display			
		Without display			
	Span point calibration				
-S	Span point calibration				
	Without span point calibration				
Calibration certificate					
-C	With calibration certificate				
	Without calibration certificate				
Model	DPT	-Priima	-AZ	-D	-S

DPT-PRIIMA

DPT-Priima is a high accuracy differential pressure transmitter designed for cleanrooms and other demanding applications. DPT-Priima has a new, extremely accurate sensor and automatic zero point calibration, and optional span point calibration and calibration certificate.

USAGE & APPLICATIONS

DPT-Priima is used in applications where the required accuracy is higher than the regular building automation pressure transmitters can reach. The most common applications are pressure monitoring in cleanrooms and over the building envelope.

OPTIONS

D: display S: span point calibration C: calibration certificate



DPT-PRIIMA TOGETHER WITH SPP
(STATIC PRESSURE PORT) IS A
COMPLETE SOLUTION FOR BUILDING
ENVELOPE MEASUREMENT

DPT-MOD DIFFERENTIAL PRESSURE TRANSMITTERS

WITH AIR FLOW MEASUREMENT AND MODBUS COMMUNICATION

ALL-IN-ONE TRANSMITTER:
MEASURE VOLUME FLOW,
VELOCITY AND DIFFERENTIAL
PRESSURE



DPT-MOD

DPT-MOD is a multifunctional transmitter for measuring volume flow, velocity, and static and differential pressure. The measurements can be read and the configuration done via Modbus communication. DPT-MOD requires less wiring than the traditional 3-wire transmitters because multiple devices can be connected on serial line.

USAGE & APPLICATIONS

The DPT-MOD is used for measuring air flow or low pressures of air and non-combustible gases in order to monitor and control building automation, HVAC and cleanroom systems. It can also be used with several different measurement probes such as FloXact™ or pitot tube, and air dampers.

TECHNICAL DETAILS

Communication:	RS-485 Modbus (RTU)
Accuracy (from applied pressure): (model 2500)	Pressure < 125 Pa = 1 % + ±2 Pa Pressure > 125 Pa = 1 % + ±1 Pa
Accuracy (from applied pressure): (model 7000)	Pressure < 125 Pa = 1.5 % + ±2 Pa Pressure > 125 Pa = 1.5 % + ±1 Pa
Zero point calibration:	automatic with autozero element (-AZ), by pushbutton or via Modbus
Measuring units:	Pressure: Pa, kPa, mbar, inchWC, mmWC, psi Flow: m³/s, m³/h, cfm, l/s, m/s, ft/min
Supply voltage:	24 VAC ±10 % / 24 VDC ±10 %
Power consumption:	< 1.3 W
Output signal:	via Modbus
Response time:	1.0-20 s, selectable via menu or via Modbus
Operating temperature:	-20...+50 °C (with autozero calibration -5...+50 °C) -40...+50 °C (-40C model)
Protection standard:	IP54

DPT-MOD

Example: DPT-MOD-2500-AZ-D	Product series DPT Differential pressure transmitter
	Model type -MOD Modbus communication
	Measuring ranges (Pa) -2500 -250...2500 -7000 -700...7000
	Zero point calibration -AZ With autozero calibration Standard with pushbutton manual zero point calibration
	Display -D With display
	Cold resistance -40C -40 °C cold resistant (not available with autozero calibration) Without -40 °C cold resistance
Model	DPT -MOD -2500 -AZ -D



NOW AVAILABLE WITH AIR FLOW MEASUREMENT
AND AUTOZERO CALIBRATION

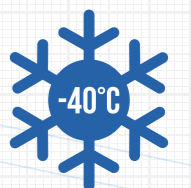

DPT-IO-MOD DIFFERENTIAL PRESSURE TRANSMITTERS

WITH MODBUS COMMUNICATION AND INPUT TERMINAL

SAVE IN COSTS OF
THE DEVICES AND
IN THE INSTALLATION
COSTS



DPT-IO-MOD

DPT-IO-MOD differential pressure transmitter for air is designed for Modbus (RTU) communication network. The DPT-IO-MOD has an input terminal that turns it into a multifunction transmitter. When using the input terminal, temperature transmitters can be replaced with temperature sensors. Very precise pressure sensor and easily operated interface make the device reliable and user-friendly.

USAGE & APPLICATIONS

The DPT-IO-MOD is used for measuring low pressures of air and non-combustible gases in order to monitor and control building automation, HVAC and cleanroom systems.

TECHNICAL DETAILS

Communication:	RS-485 Modbus (RTU)
Accuracy (from applied pressure):	Pressure < 125 Pa = 1 % + ±2 Pa Pressure > 125 Pa = 1 % + ±1 Pa
Accuracy (from applied pressure):	Pressure < 125 Pa = 1.5 % + ±2 Pa Pressure > 125 Pa = 1.5 % + ±1 Pa
Zero point calibration:	by pushbutton or via Modbus
Measuring units:	Pa, kPa, mbar, inchWC, mmWC, psi
Supply voltage:	24 VDC ±10 % / 24 VAC ±10 %
Power consumption:	< 1.3 W
Output signal:	via Modbus
Operating temperature:	-20...+50 °C
Response time:	1...20 s selectable via menu
Protection standard:	IP54

DPT-IO-MOD

Example: DPT-IO-MOD-2500-D	Product series	DPT	Differential pressure transmitter
	Model type	-IO-MOD	Input terminal and Modbus communication
	Measuring ranges (Pa)		
	-2500	-250...2500	
	-7000	-700...7000	
Display			
-D	With display		
Model	DPT	-IO-MOD	-2500

Traditional system:

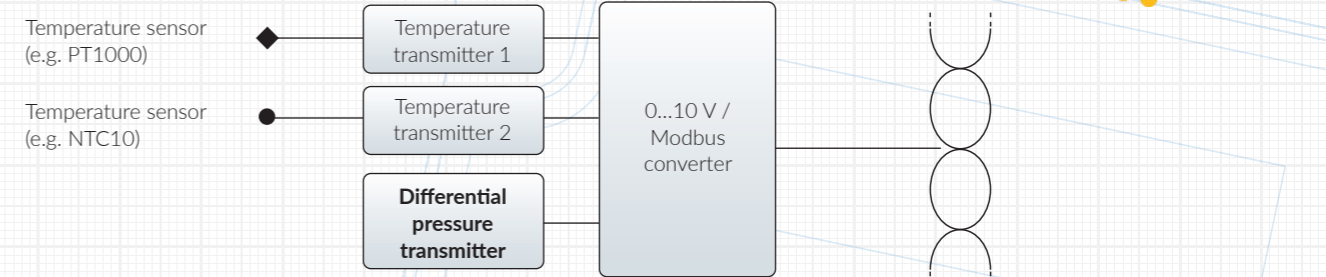

New system with DPT-IO-MOD or DPT-Dual-MOD

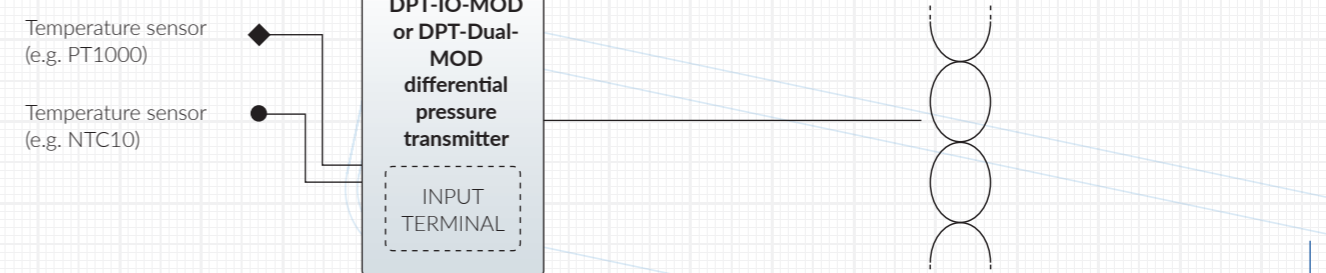

DPT-DUAL-MOD DIFFERENTIAL PRESSURE TRANSMITTERS

WITH TWO PRESSURE SENSORS AND MODBUS COMMUNICATION

AHU MODEL INCLUDES
AN AIR FLOW
TRANSMITTER



DPT-DUAL-MOD

DPT-Dual-MOD combines two differential pressure transmitters into one device. It offers a possibility to measure pressure from two different points. One of the measurements can be set to show the air flow rate. DPT-Dual-MOD has a Modbus interface and an Input terminal. When using the Input terminal, temperature transmitters can be replaced with temperature sensors. As a result, you will save in costs of the devices and in the installation costs. The AHU model that includes an air flow transmitter has been designed especially for ventilation units.

USAGE & APPLICATIONS

DPT-Dual-MOD can be used in all applications where you need to measure two different pressures. With the AHU model one of the measurements can be air flow. The devices are suitable for air and non-combustible gases.

TECHNICAL DETAILS

Communication:	RS-485 Modbus (RTU)
Accuracy (from applied pressure):	Pressure < 125 Pa = 1 % + ±2 Pa Pressure > 125 Pa = 1 % + ±1 Pa
Accuracy (from applied pressure):	Pressure < 125 Pa = 1.5 % + ±2 Pa Pressure > 125 Pa = 1.5 % + ±1 Pa
Zero point calibration:	by pushbutton or via Modbus
Measuring units:	Pressure: Pa, kPa, mbar, inchWC, mmWC, psi Flow: (AHU model) m³/s, m³/h, cfm, l/s, m/s, ft/min
Supply voltage:	24 VDC ±10 % / 24 VAC ±10 %
Power consumption:	< 1.3 W
Output signal:	via Modbus
Operating temperature:	-20...+50 °C
Response time:	1...20 s selectable via menu
Protection standard:	IP54

DPT-DUAL-MOD

Example:	Product series	DPT Differential pressure transmitter	
DPT-Dual-MOD-2500-D	DPT	Differential pressure transmitter	
		Model type	
		-Dual-MOD	Two pressure sensors and Modbus communication
		Measuring ranges (Pa)	
		-2500	-250...2500
		-7000	-700...7000
		-AHU	both 2500 and 7000 sensors, with flow measurement
		Display	
		-D	With display
Model	DPT	-Dual-MOD	-2500
			-D

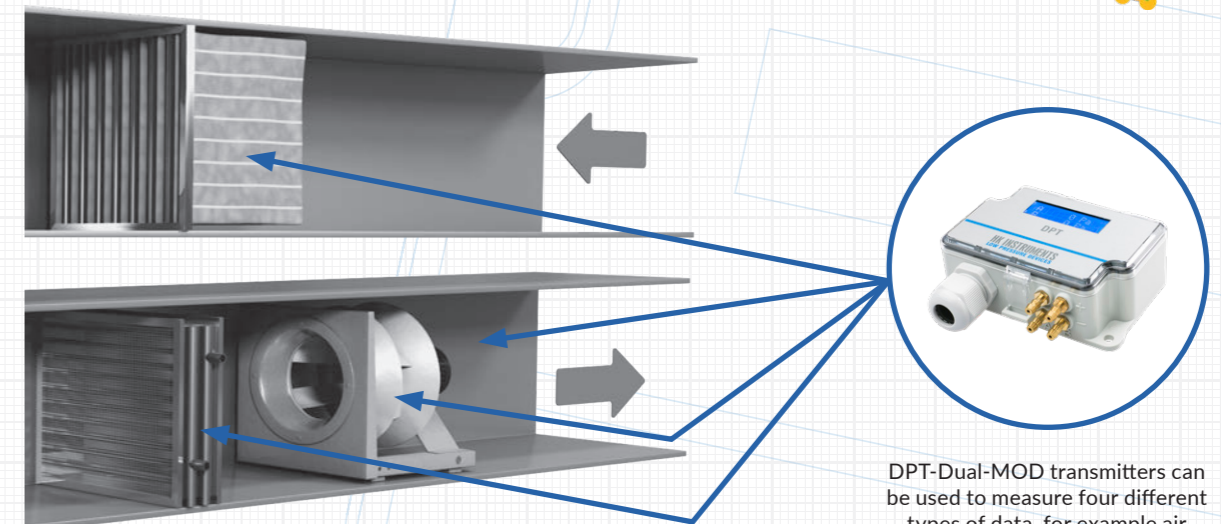

DPT-Dual-MOD transmitters can be used to measure four different types of data, for example air flow, filter condition, heating coil and air temperature.

DPT-DUAL DIFFERENTIAL PRESSURE TRANSMITTERS

WITH TWO PRESSURE SENSORS



TECHNICAL DETAILS

Accuracy (from applied pressure):	Pressure < 125 Pa = 1 % + ±2 Pa (model 2500) Pressure > 125 Pa = 1 % + ±1 Pa
Accuracy (from applied pressure):	Pressure < 125 Pa = 1.5 % + ±2 Pa (model 7000) Pressure > 125 Pa = 1.5 % + ±1 Pa
Zero point calibration:	by pushbutton
Measuring units:	Pa, kPa, mbar, inchWC, mmWC, psi
Supply voltage:	24 VDC ±10 % / 24 VAC ±10 %
Power consumption:	< 1.0 W
Output signals (3-wire):	2 x 0...10 VDC or 2 x 0...5 VDC (selectable by jumper)
Operating temperature:	-20...+50 °C
Response time:	0.8 / 4 s
Protection standard:	IP54

DPT-DUAL

Example: DPT-Dual-2500-D	Product series			
	DPT	Differential pressure transmitter		
	Model type			
	-Dual	With two pressure sensors		
	Measuring ranges (Pa)			
	-2500	-100...+100 / 0...100 / 0...250 / 0...500 / 0...1000 / 0...1500 / 0...2000 / 0...2500		
	-7000	0...1000 / 0...1500 / 0...2000 / 0...2500 / 0...3000 / 0...4000 / 0...5000 / 0...7000		
		Display		
	-D	With display		
		Without display		
Model	DPT	-Dual	-2500	-D

DPT-DUAL

DPT-Dual series differential pressure transmitters are engineered for building automation in the HVAC/R industry. DPT-Dual is a technologically advanced transmitter measuring static and differential pressure from two different points, with field selectable units, range and output, all in a single device.

USAGE & APPLICATIONS

The differential pressure transmitter is used for measuring low pressures of air and non-combustible gases in order to monitor and control building automation and HVAC systems.

DPT-2W DIFFERENTIAL PRESSURE TRANSMITTERS

TWO-WIRE



TECHNICAL DETAILS

Accuracy (from FS):	±1.5 %
Long term stability, typical 1 year:	≤ ± 8 Pa; model 2500
Measuring unit:	Pa
Zero point calibration:	by pushbutton
Supply voltage:	10...35 VDC
Output signal:	4...20 mA
Operating temperature:	-10...+50 °C
Response time:	0.8 / 4 s
Protection standard:	IP54

DPT-2W

Example: DPT-2W-2500-R8-D	Product series			
	DPT-2W	Differential pressure transmitter with 2-wire configuration		
	Measuring ranges (Pa)			
	-2500 -100...+100 / 0...100 / 0...250 / 0...500 / 0...1000 / 0...1500 / 0...2000 / 0...2500			
Model	Model type			
	-R8	Eight measuring ranges		
	Display			
	-D	With display		
		Without display		
Model	DPT-2W	-2500	-R8	-D

LOOP-POWERED 4–20 mA TRANSMITTER

DPT-2W

The DPT-2W is a differential pressure transmitter with two-wire connection.

USAGE & APPLICATIONS

The differential pressure transmitter is used for measuring low pressures of air and non-combustible gases in order to monitor and control building automation, HVAC and cleanroom systems.

DPI ELECTRONIC DIFFERENTIAL PRESSURE SWITCH AND TRANSMITTER

THE RIGHT CHOICE WHEN
YOU NEED AN AIR
PRESSURE ALARM



TECHNICAL DETAILS

Accuracy (from FS):	±1.5 % (±0.7 % with span point calibration) (including: general accuracy, temperature drift, linearity, hysteresis, and repetition error)
Long term stability, typical 1 year:	±1 Pa (±8 Pa without autozero element -AZ)
Zero point calibration:	automatic with autozero element (-AZ) or by using the buttons on the lid
Supply voltage:	21-35 VDC / 24 VAC ±10 % (without -AZ option) 24 VDC ±10 % / 24 VAC ±10 % (with -AZ option)
Current consumption:	35 mA + relays (7 mA each) + AZ (20 mA) + 0...10 V output (10 mA)
Output signals:	0...10 V Relay output 1 (250 VAC / 30 VDC / 6 A) Optional relay output 2 (250 VAC / 30 VDC / 6 A)
Operating temperature:	-10...+50 °C (with autozero calibration -5...+50 °C)
Response time:	0.5...10 s
Protection standard:	IP54

DPI

Example: DPI±500-2R-D	Product series			
	DPI	Electronic differential pressure switch and transmitter		
	Measuring ranges (Pa)			
	±500	-100...100 / -250...250 / -300...300 / -500...500		
	2500	0...100 / 0...250 / 0...1000 / 0...2500		
	Number of relays			
	-1R	One relay		
	-2R	Two relays		
	Zero point calibration			
	-AZ	With autozero calibration		
		Standard with manual zero point calibration		
	Display			
	-D	With display		
	-D			
Model	DPI	±500	-1R	-D

UP TO TWO RELAYS WHICH CAN BE CONFIGURED SEPARATELY

ALSO WITH AUTOZERO CALIBRATION

DPI

The DPI is an electronic differential pressure switch and transmitter with up to two relay outputs.

USAGE & APPLICATIONS

The DPI is used for measuring and indicating low pressures of air and non-combustible gases in order to monitor and control building automation, HVAC and cleanroom systems.

AIR FLOW AND VELOCITY TRANSMITTERS

DPT-Flow transmitters are unique devices that make measuring air flow easier than ever before. Together with FloXact™ measurement probes the same devices are the right option when measuring flow in a duct. Again, if you wish to measure air velocity, your selection would be AVT which offers multiple measuring ranges in a single device together with relay and temperature output signals. DPT-Flow-Batt is an on-site display for air flow or differential pressure designed for environments where electricity is not available.



DPT-FLOW



FLOXACT™



DPT-FLOW-BATT



AVT

FLOW MEASUREMENT

PRODUCT SELECTION GUIDE

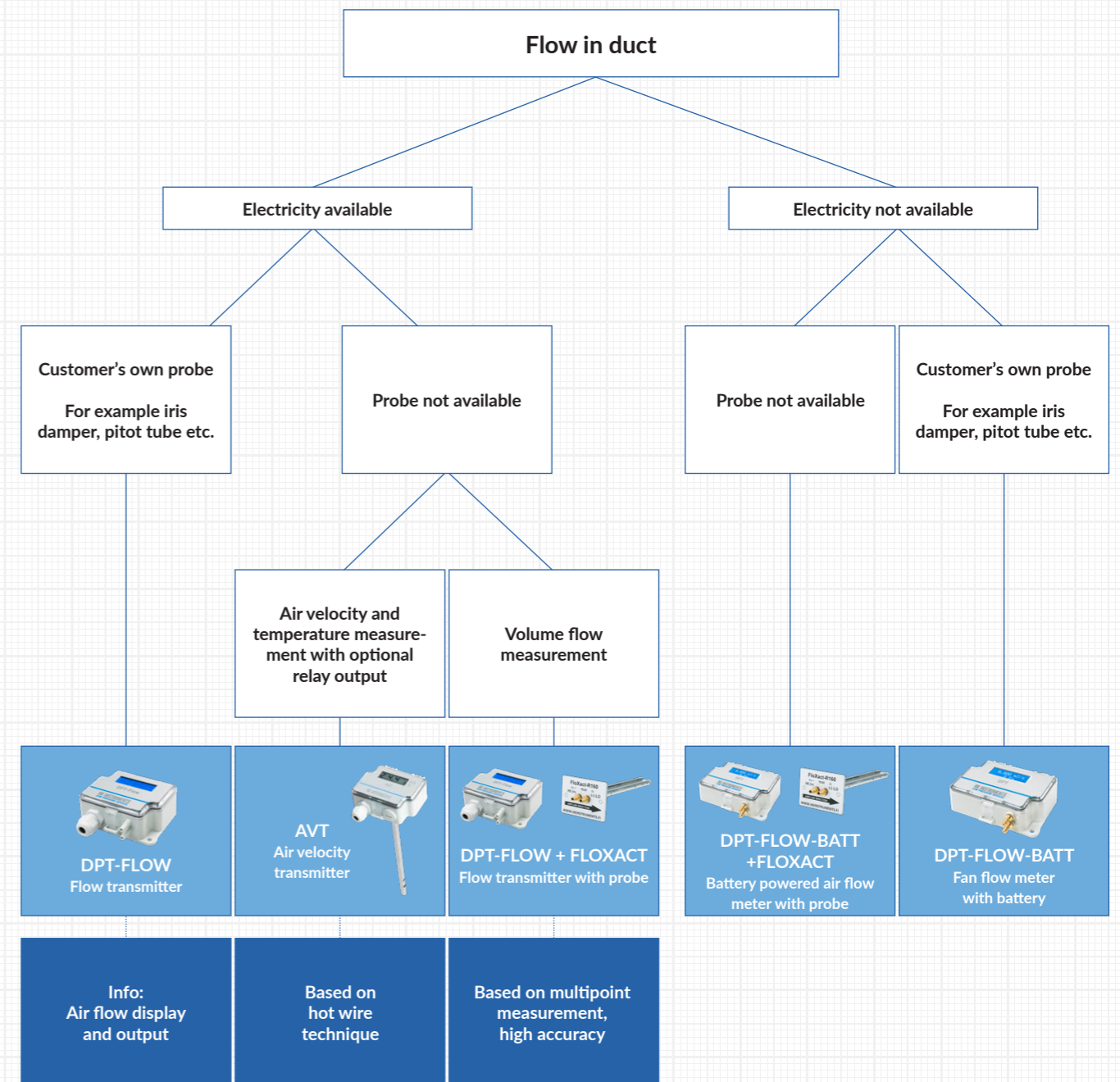
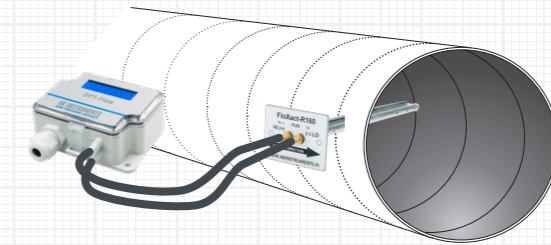
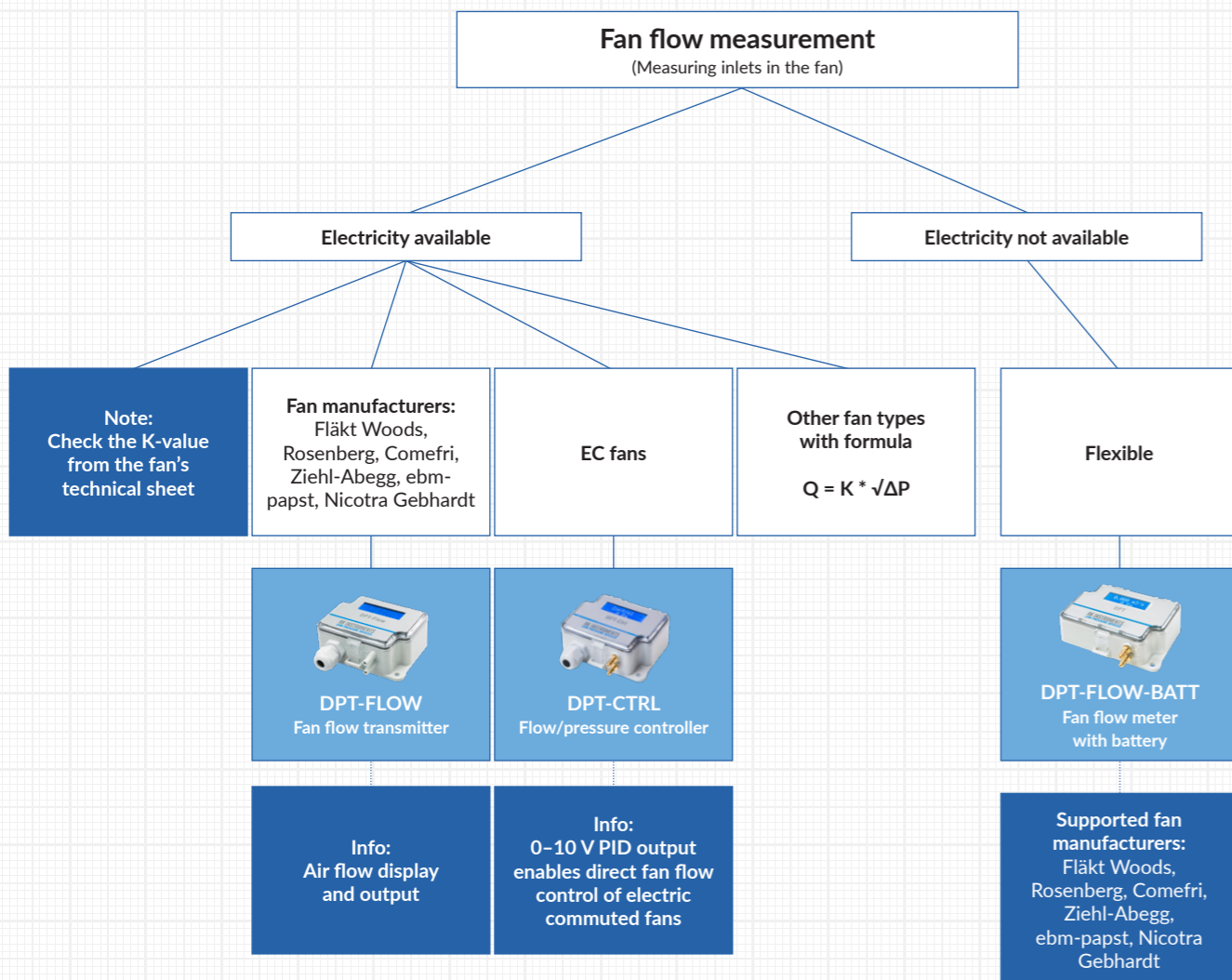
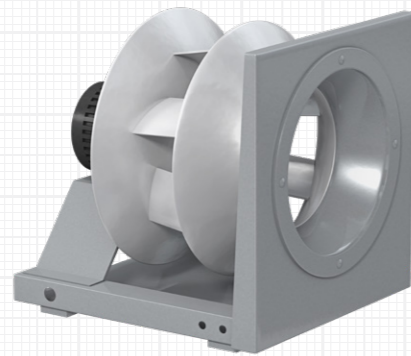

DPT-FLOW FLOW TRANSMITTER FOR HVAC SYSTEMS

IDEAL PRODUCT FOR
MEASURING THE FLOW
RATE BOTH ON CENTRIFUGAL
FANS AND IN A DUCT SYSTEM



DPT-FLOW

DPT-Flow is a flow transmitter that provides an easy way to measure the flow rate on centrifugal fans or in a duct system. One device is suitable for a range of fan types. It can also be used with several different measurement probes such as FloXact™ or pitot tube, and air dampers.

USAGE

The DPT-Flow can be used to measure the air flow on centrifugal fans or as a transmitter to regulate the air flow in a duct or on the selected fan or blower. It can also be used in a duct system or in air-handling units as an on-site display for flow.

APPLICATIONS

The DPT-Flow is an ideal instrument for air flow monitoring and control, and fan and blower control.

TECHNICAL DETAILS

Accuracy (from applied pressure): (models 1000 and 2000)	Pressure < 125 Pa = 1 % + ±2 Pa Pressure > 125 Pa = 1 % + ±1 Pa
Accuracy (from applied pressure): (models 5000 and 7000)	Pressure < 125 Pa = 1.5 % + ±2 Pa Pressure > 125 Pa = 1.5 % + ±1 Pa
Zero point calibration:	automatic with autozero element (-AZ) or by pushbutton
Measuring units:	Pressure: Pa, kPa, mbar, inchWC, mmWC, psi Flow: m³/s, m³/h, cfm, l/s, m/s, ft/min
Supply voltage:	24 VAC ±10 % / 24 VDC ±10 %
Power consumption:	< 1.0 W -40C model: <4.0 W when <0 °C
Output signals for pressure and air flow (selectable by jumper):	0...10 VDC 4...20 mA
Operating temperature:	-20...+50 °C (with autozero calibration -5...+50 °C) -40...+50 °C (-40C model)
Response time:	1...20 s
Protection standard:	IP54

ALSO USABLE WITH
MEASUREMENT PROBES
SUCH AS FLOXACT™,
PITOT TUBES,
AND AIR DAMPERS

DPT-FLOW

Example: DPT-Flow-2000-AZ-D	Product series			
	DPT-Flow	Flow transmitter for HVAC systems		
	Measuring ranges (Pa)			
	-1000	0...1000		
	-2000	0...2000		
	-5000	0...5000		
	-7000	0...7000		
	Zero point calibration			
	-AZ	With autozero calibration		
		Standard with pushbutton manual zero point calibration		
	Display			
	-D	With display		
	Cold resistance			
	-40C	-40 °C cold resistant (not available with autozero calibration)		
		Without -40 °C cold resistance		
Model	DPT-Flow	-2000	-AZ	-D

PRE-PROGRAMMED FAN MANUFACTURERS

Fläkt Woods, Rosenberg, Nicotra Gebhardt, Comefri, Ziehl-Abegg, ebm-papst

The fan only needs to have a pressure tap/port to which the DPT-Flow can be connected

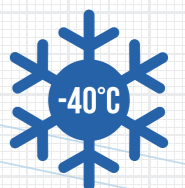

FLOXACT™ AVERAGING MULTI-POINT PITOT TUBE FOR FLOW MEASUREMENTS



FLOXACT™

The FloXact™ probe is a differential air pressure device designed to measure air volume flow in a duct. It includes multiple sensing points to measure total and static pressures. The FloXact™ probe incorporates a unique design to amplify the differential pressure by 2.5 times for accurate measurement of lower air velocities down to 1.0 m/s (200 fpm). It is easy to install and cost-effective.

DESIGN FEATURES

- Multiple sensing points for greater accuracy
- Easy installation
- Chamfered sensing points for consistent readings
- 2 % accuracy
- 2.5 X signal amplification
- Accepts 1/4" OD tubing

OPERATION

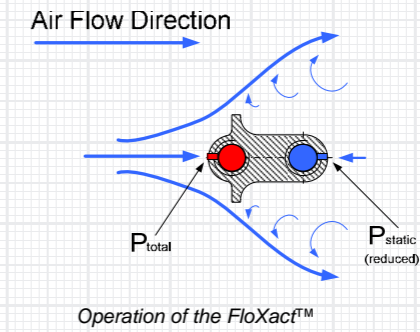

INSTALLATION

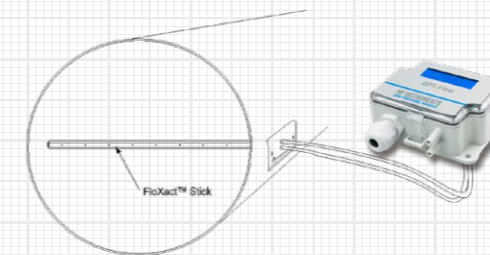

Figure 1. FloXact™ -R mounting.

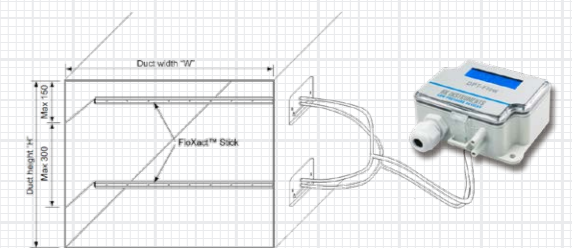
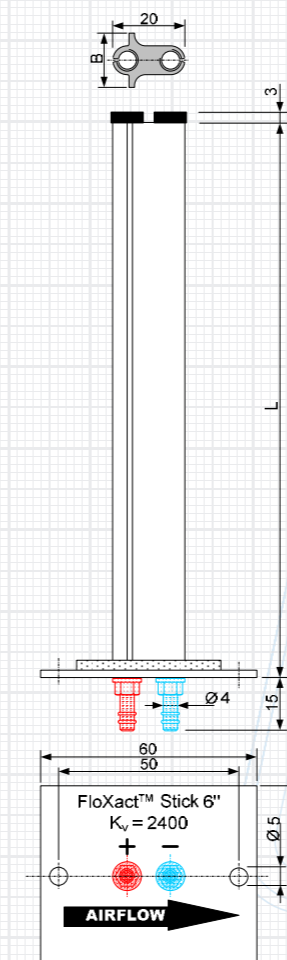

Figure 2. FloXact™ -L mounting.

DIMENSIONS

FloXact™-R available models :
All standard round duct sizes up to 1500 m



FloXact™-L available models :
250, 300, ... 1500 (50 mm steps)

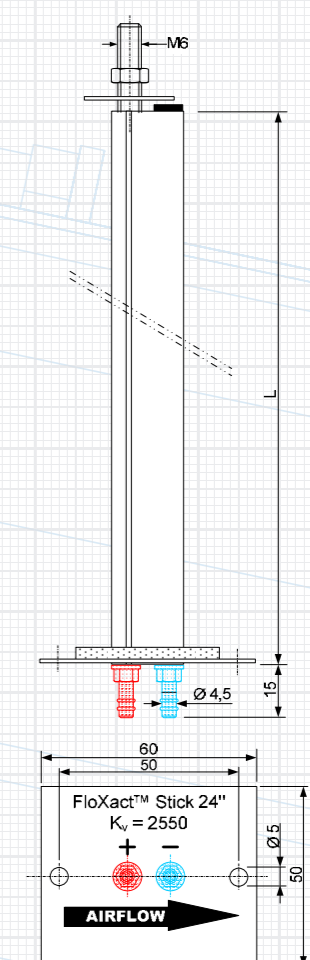

DPT-FLOW-BATT BATTERY POWERED DIFFERENTIAL PRESSURE AND AIR FLOW METER

MEASURE THE AIR FLOW
IN ENVIRONMENTS WHERE
ELECTRICITY IS
NOT AVAILABLE



DPT-FLOW-BATT

DPT-Flow-Batt is a user-friendly on-site display for air flow or differential pressure designed for environments and applications where electricity is not available. One device is suitable for a range of different fan types. It also provides an easy way to measure the flow rate in a duct system for example together with a FloXact™ averaging measurement probe.

USAGE & APPLICATIONS

DPT-Flow-Batt is an on-site display designed for air handling units to measure the air flow on centrifugal fans. DPT-Flow-Batt can also be used in the duct system as an on-site display for flow. The device can be used with several different measurement probes such as FloXact™ or pitot tube, and air dampers. The requirement is that the K-value of the measurement probe or damper is known.

TECHNICAL DETAILS

Accuracy (from FS):	±1.5 % (Including: general accuracy, temperature drift, linearity, hysteresis, long term stability, and repetition error)
Zero point calibration:	by pushbutton
Measuring units:	Pressure: Pa, kPa, mbar, inchWC, mmWC, psi Flow: m³/s, m³/h, cfm, l/s, m/s, ft/min
Supply voltage:	9 V battery
Current consumption:	~20 mA on active mode
Operating temperature:	-20...+50 °C
Response time:	1.0-10 s, selectable via menu
Protection standard:	IP54

DPT-FLOW-BATT

Example: DPT-Flow-Batt-7000-D	Product series	
	DPT-Flow-Batt	Battery powered air flow meter
Model	Measuring ranges (Pa)	
	-7000	0...7000
Model	Display	
	-D	With display
Model	DPT-Flow-Batt	-7000 -D

AVT AIR VELOCITY AND TEMPERATURE TRANSMITTER

WITH RELAY OUTPUT



AVT
The AVT is an electronic air velocity and temperature transmitter for air and non-combustible gases with optional relay output.

USAGE
AVT is used in HVAC and building automation systems.

APPLICATIONS
Monitoring air velocity and temperature in ducts and laminar flow cabinets, and at ventilators and dampers.

TECHNICAL DETAILS

Accuracy (from reading):	< 0.2 m/s + 5 % (Range 0...2 m/s) < 0.5 m/s + 5 % (Range 0...10 m/s) < 1.0 m/s + 5 % (Range 0...20 m/s)
Measuring units:	m/s, °C
Supply voltage:	24 VDC ±10 % / 24 VAC ±10 %
Power consumption:	35 mA (50 mA with relay) + 40 mA with mA outputs
Output signal 1:	0...10 V or 4...20 mA (linear to °C)
Output signal 2:	0...10 V or 4...20 mA (linear to m/s)
Optional relay output:	Potential free SPDT 250 VAC, 6 A / 30 VDC, 6 A with adjustable switching point and hysteresis
Operating temperature:	0...+50 °C
Probe:	Adjustable immersion length 50...180 mm, mounting flange included
Protection standard:	IP54

AVT

Example: AVT-D-R	Product series		
	AVT	Air velocity transmitter, measuring ranges 0...2 / 0...10 / 0...20 m/s	
	Display		
	-D	With display	
		Without display	
	Relay		
	-R	With relay	
		Without relay	
Model	AVT	-D	-R

PRESSURE AND FLOW CONTROLLERS

The DPT-Ctrl series PID controllers are engineered for stand-alone building automation in the HVAC/R industry. With the built-in controller it is possible to control the constant pressure or flow of fans, VAV systems or dampers. DPT-Ctrl series offers various models for energy-efficient control of modern EC fans in all sizes of systems.

The DPT-Ctrl-MOD can be used as a pressure or flow controller in modular building automation systems. Setpoints and other parameters can be adjusted remotely via bus. With the temperature compensation feature, the fan speed can be adjusted according to temperature. This saves energy by exhausting the right amount of air in cold environments.



DPT-CTRL



DPT-CTRL-MOD

DPT-CTRL PID CONTROLLERS

WITH DIFFERENTIAL PRESSURE OR AIR FLOW TRANSMITTER



DPT-CTRL

DPT-CTRL is a multifunctional PID controller with differential pressure or air flow transmitter. It enables controlling constant pressure or flow of fans, VAV systems or dampers. When controlling flow, it is possible to select a fan manufacturer or a common measuring probe that has a K-value.

USAGE & APPLICATIONS

DPT-CTRL can be used to control air flow or constant pressure in applications where it is important to keep a constant vacuum or a steady air flow, such as vacuuming units in renovation sites that keep a constant negative pressure so that impurities do not spread to other spaces.

TECHNICAL DETAILS

Accuracy (from applied pressure): (model 2500)	Pressure < 125 Pa = 1 % + ±2 Pa Pressure > 125 Pa = 1 % + ±1 Pa
Accuracy (from applied pressure): (model 7000)	Pressure < 125 Pa = 1.5 % + ±2 Pa Pressure > 125 Pa = 1.5 % + ±1 Pa
Measuring units:	Pressure: Pa, kPa, mbar, inchWC, mmWC, psi Flow: m³/s, m³/h, cfm, l/s, m/s, ft/min
Control signal:	0...10 VDC
Output signal for pressure or air flow (selectable via menu):	0...10 VDC 4...20 mA
PID-parameters:	Adjustable via menu
Zero point calibration:	Automatic with autozero element (-AZ) or by pushbutton
Supply voltage:	24 VDC ±10 % / 24 VAC ±10 %
Power consumption:	< 1.0 W
Operating temperature:	-20...+50 °C with autozero (-AZ) calibration -5...+50 °C -40...+50 °C (-40C model)
Protection standard:	IP54

DPT-CTRL

Example: DPT-CTRL-2500-AZ-D	Product series			
	DPT-CTRL	Pressure and flow controller		
	Measuring ranges (Pa)			
	-2500	0...2500		
	-7000	0...7000		
	Zero point calibration			
	-AZ	With autozero calibration		
		Standard with pushbutton manual zero point calibration		
	Display			
	-D	With display		
	Cold resistance			
	-40C	-40 °C cold resistant (not available with autozero calibration)		
		Without -40 °C cold resistance		
Model	DPT-CTRL	-2500	-AZ	-D

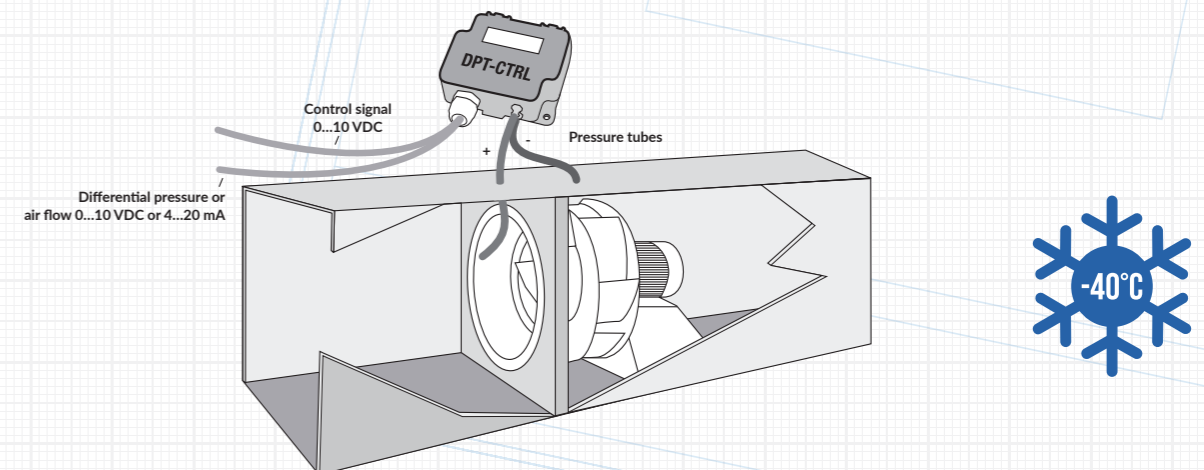

DPT-CTRL-MOD PID CONTROLLERS

WITH DIFFERENTIAL PRESSURE OR AIR FLOW TRANSMITTER
AND MODBUS COMMUNICATION



DPT-CTRL-MOD

The DPT-Ctrl-MOD controller is engineered for building automation in the HVAC industry. With the built-in controller of the DPT-Ctrl-MOD it is possible to control the constant pressure or flow of fans, VAV systems or dampers. When controlling air flow, it is possible to select a fan manufacturer or a common measuring probe that has a K-value. Modbus communication enables remote adjustment of the setpoint and other parameters, so it can be used as a part of building management systems (BMS).

USAGE & APPLICATIONS

DPT-Ctrl-MOD is designed to be used in buildings with a BMS to control air flow or constant pressure of an individual zone. A building operator can easily monitor and adjust the parameters via Modbus. The outdoor temperature compensation feature brings energy savings in cold areas automatically by decreasing extract air flow rates to preserve warm air.

TECHNICAL DETAILS

Communication:	RS-485 Modbus (RTU)
Accuracy (from applied pressure):	Pressure < 125 Pa = 1 % + ±2 Pa Pressure > 125 Pa = 1 % + ±1 Pa
Measuring units:	Pressure: Pa, kPa, mbar, inchWC, mmWC, psi Flow: m ³ /s, m ³ /h, cfm, l/s, m/s, ft/min
Control signal:	0...10 VDC
PID-parameters:	Selectable via menu and Modbus
Zero point calibration:	via Modbus or by pushbutton
Supply voltage:	24 VDC ±10 % / 24 VAC ±10 %
Power consumption:	< 1.0 W
Output signal:	via Modbus
Operating temperature:	-20...+50 °C
Protection standard:	IP54

DPT-CTRL-MOD

Example: DPT-Ctrl-MOD- 2500-D	Product series			
	DPT-Ctrl	Pressure and flow controller		
	Model type			
	-MOD	Modbus communication		
	Measuring ranges (Pa)			
	-2500	-250...2500		
	-7000	-700...7000		
Display				
	-D	With display		
Model	DPT-Ctrl	-MOD	-2500	-D



**OUTSIDE AIR TEMPERATURE COMPENSATION FUNCTION AND FIXED OUTPUT
FUNCTION VIA MENU AND MODBUS**

**2SP FEATURE WITH A BINARY INPUT TO SELECT BETWEEN TWO USER-
ADJUSTABLE SETPOINTS**

CARBON DIOXIDE TRANSMITTERS

CDT2000 series products are versatile devices that measure CO₂ concentration and temperature. These devices are available for duct or wall mounting. CDT2000 is the first device measuring CO₂ with a large touchscreen display enabling easy configuration and adjustment. CDT2000 Duct is a cost-effective solution for measuring the total concentration of CO₂ in duct systems.



CDT2000



CDT2000 DUCT

CDT2000 CARBON DIOXIDE TRANSMITTERS

WALL MOUNTED

TOUCHSCREEN
DISPLAY
FOR EASY
ADJUSTMENT



CDT2000

CDT2000 combines CO₂ concentration, temperature and optional relative humidity measurements into one easy-to-use device with a touchscreen display. It offers easy installation and adjustment, several different model options and various output signals that are configurable separately for each measurement parameter. CDT2000 utilizes the industry standard NDIR measurement principle with self-calibrating ABC logic™ for CO₂ measurement. CDT2000-DC is a dual channel model with a measuring channel and a reference channel that makes a continuous comparison and the necessary adjustment accordingly. CDT2000-DC is also suitable for buildings that are continuously occupied.

USAGE & APPLICATIONS

CDT2000 wall mount model is used to monitor and control CO₂ and humidity levels in offices, public spaces, meeting rooms and classrooms. CDT2000-DC series devices can also be used in applications where there is a constant source of carbon dioxide present (for example hospitals and greenhouses).

TECHNICAL DETAILS

Accuracy:	CO ₂ : ±40 ppm + 2 % of reading, DC model: 75 ppm or 10 % of reading (whichever is greater) Temperature: <0.5 °C Relative humidity: ±2...3 % rH at 0...50 °C and 10...90 % rH Total error band includes accuracy, hysteresis and temperature effect over 5...50 °C and 10-90 % rH
Measuring units:	ppm, °C, % rH
Calibration:	Automatic self-calibration, ABC Logic™ or continuous comparison (DC)
Supply voltage:	24 VDC/VAC ±10 %
Output signal 1:	0/2...10 V or 4...20 mA (linear to CO ₂)
Optional output signal 2:	0/2...10 V or 4...20 mA (linear to rH)
Output signal 3:	0/2...10 V or 4...20 mA (linear to Temp)
Optional relay output:	Potential free SPDT 250 VAC, 6 A / 30 VDC, 6 A with adjustable switching point and hysteresis
Operating temperature:	0...+50 °C
Protection standard:	IP20

CDT2000-DC IS ALSO SUITABLE FOR BUILDINGS THAT ARE CONTINUOUSLY OCCUPIED

CDT2000

Example:	Product series
CDT2000-1R-D	CDT2000 Carbon dioxide transmitter, analog outputs
	CDT-MOD-2000 Carbon dioxide transmitter, Modbus communication
	Calibration
	ABC logic™, Automatic Background Calibration
	-DC Dual channel, for continuously occupied space
	Mounting
	Wall mount
	Relay
	-1R With relay
	Without relay
	Relative humidity sensor
	-rH With relative humidity sensor
	Without relative humidity sensor
	Display
	-D With display
	Without display
Model	CDT2000 -1R -D



TIME EXTENSION BUTTON ENABLES BOOSTING VENTILATION MANUALLY USING THE TOUCH-SCREEN DISPLAY

CDT2000 DUCT CARBON DIOXIDE TRANSMITTERS

DUCT MOUNTED

MEASURE THE TOTAL
CONCENTRATION OF CO₂
WHERE ROOM MEASUREMENT
IS NOT POSSIBLE



CDT2000 DUCT

CDT2000 Duct combines CO₂ and temperature measurements into one device installed in a ventilation duct. Illuminated display ensures easy readability also from a distance. The CDT2000 Duct has a screwless lid and an easily adjustable mounting flange that make installing the device easy. CDT2000 utilizes the industry standard NDIR measurement principle with self-calibrating ABC logic™ for CO₂ measurement. CDT2000-DC is a dual channel model with a measuring channel and a reference channel that makes a continuous comparison and the necessary adjustment accordingly. CDT2000-DC is also suitable for buildings that are continuously occupied.

USAGE & APPLICATIONS

CDT2000 Duct is used to monitor and control CO₂ concentration of incoming and return air in a ventilation system. CDT2000-DC Duct series devices can also be used in applications where there is a constant source of carbon dioxide present (for example hospitals and greenhouses).

TECHNICAL DETAILS

Accuracy:	CO ₂ : ±40 ppm + 2 % of reading, DC model: 75 ppm or 10 % of reading (whichever is greater) Temperature: <0.5 °C
Measuring units:	ppm, °C
Calibration:	Automatic self-calibration, ABC Logic™ or continuous comparison (DC)
Supply voltage:	24 VDC/VAC ±10 %
Output signal 1:	0/2...5/10 V (linear to CO ₂)
Output signal 2:	0/2...5/10 V (linear to Temp)
Optional output signal 3:	4...20 mA (linear to CO ₂) (A model)
Optional output signal 4:	4...20 mA (linear to Temp) (A model)
Operating temperature:	0...+50 °C
Protection standard:	IP54

CDT DUCT

Example: CDT2000 Duct-D	Product series		
	CDT2000	Carbon dioxide transmitter, analog outputs	
	CDT-MOD-2000	Carbon dioxide transmitter, Modbus communication	
	Calibration		
		ABC logic™, Automatic Background Calibration	
	-DC	Dual channel, for continuously occupied space	
	Mounting		
	Duct	Duct mount	
	Output		
		Voltage output	
	-A	Voltage and current output	
	Display		
	-D	With display	
		Without display	
Model	CDT2000	Duct	-D



ALSO AVAILABLE WITH MODBUS COMMUNICATION AND mA OUTPUT

HUMIDITY TRANSMITTERS

RHT series devices measure relative humidity (rH) and temperature. They are available for duct or wall mounting. The configuration and adjustment of the RHT is quick and easy because of the large touchscreen display. RHT Duct is a user-friendly solution for measuring relative humidity in air ducts.



RHT



RHT DUCT

RHT HUMIDITY TRANSMITTERS

WALL MOUNTED

TOUCHSCREEN
DISPLAY
FOR EASY
ADJUSTMENT



RHT

RHT is a wall mounted relative humidity and temperature transmitter that offers several different model options for easy customizability.

USAGE & APPLICATIONS

RHT wall mount model is used to monitor and control relative humidity levels in offices, public spaces, hospitals, meeting rooms and classrooms.

TECHNICAL DETAILS

Accuracy:	Temperature: <0.5 °C Relative humidity: ±2...3 % rH at 0...50 °C and 10...90 % rH Total error band includes accuracy, hysteresis and temperature effect over 5...50 °C and 10-90 % rH
Measuring units:	°C, % rH
Supply voltage:	24 VDC/VAC ±10 %
Output signal 1:	0/2...10 V or 4...20 mA (linear to rH)
Output signal 2:	0/2...10 V or 4...20 mA (linear to Temp)
Optional relay output:	Potential free SPDT 250 VAC, 6 A / 30 VDC, 6 A with adjustable switching point and hysteresis
Operating temperature:	0...+50 °C
Protection standard:	IP20

RHT

Example: RHT-1R-D	Product series		
	RHT	Relative humidity transmitter, analog outputs	
RHT-MOD	Relative humidity transmitter, Modbus communication		
	Mounting		
	Wall mount		
	Relay		
	-1R	With relay	
		Without relay	
	Display		
	-D	With display	
		Without display	
Model	RHT	-1R	-D



ALSO AVAILABLE WITH MODBUS COMMUNICATION

RHT DUCT HUMIDITY TRANSMITTERS

DUCT MOUNTED



RHT DUCT

RHT Duct is a duct mounted humidity and temperature transmitter available also with an illuminated display.

USAGE & APPLICATIONS

RHT Duct is used to monitor and control relative humidity of incoming and return air in ventilation system.

TECHNICAL DETAILS

Accuracy:	Temperature: <0.5 °C Relative humidity: ±2...3 % rH at 0...50 °C and 10...90 % rH Total error band includes accuracy, hysteresis and temperature effect over 5...50 °C and 10-90 % rH
Measuring units:	°C, % rH
Supply voltage:	24 VDC/VAC ±10 %
Output signal 1:	0/2...5/10 V (linear to rH)
Output signal 2:	0/2...5/10 V (linear to Temp)
Optional output signal 3:	4...20 mA (linear to rH) (A model)
Optional output signal 4:	4...20 mA (linear to Temp) (A model)
Operating temperature:	0...+50 °C
Protection standard:	IP54

RHT DUCT

Example: RHT Duct-D	Product series		
	RHT	Relative humidity transmitter, analog outputs	
	RHT-MOD	Relative humidity transmitter, Modbus communication	
	Mounting		
	Duct	Duct mount	
	Output		
			Voltage output
	-A	Voltage and current output	
	Display		
	-D	With display	
		Without display	
Model	RHT	Duct	-D



ALSO AVAILABLE WITH MODBUS COMMUNICATION AND mA OUTPUT

INDOOR AIR QUALITY

Easily customizable Siro indoor air quality transmitters measure carbon dioxide, VOC (volatile organic compound), PM (particulate matter), relative humidity and temperature.

Measuring CO₂ concentration in the indoor air is important. If the concentration is too high, people feel tired and get headaches, which decreases work efficiency and learning skills. If the concentration is in a good level, the air quality in general is also good and the ventilation efficient enough. This indicates that the quantity of airborne viruses and other particles in the indoor air is low. Measuring CO₂ concentration also helps in achieving demand-controlled ventilation, which improves the energy efficiency of the building. In big picture, this helps to control the climate change.

The VOC concentration is measured to regulate demand-controlled ventilation and to keep the indoor air quality in a good level. The VOC molecules originate from both people and materials (for example building materials, cigarette smoke, detergents) and can be harmful to people.

The PM sensor measures the size and amount of particulates in the indoor air. The particulates originate from, for example, traffic, industry, energy production and all burning processes. The particulates are globally one of the most important factors affecting the air quality and human health. The smaller the particulate, the more harmful it is. The PM measurements are made, for example, to assess the performance of air filters or to see if the cleaning in public places is at an adequate level.



SIRO



SIR-MOD

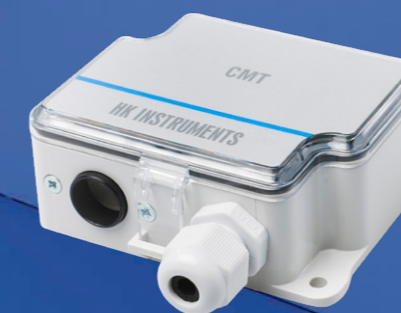

CMT

SIRO INDOOR AIR QUALITY TRANSMITTERS

ALL THE MOST
RELEVANT IAQ
SENSORS IN
ONE DEVICE



SIRO

Siro is an indoor air quality transmitter with a modern design and new hardware, including sensors. The transmitter is available with several optional air quality sensors including temperature, relative humidity, CO₂ concentration, VOC (Volatile Organic Compounds) and PM (Particulate Matter). It offers easy installation and adjustment, several different model options and various output signals that are configurable separately for each measurement parameter. Siro utilizes the industry standard NDIR measurement principle with self-calibrating ABC logic™ for CO₂ measurement.

USAGE & APPLICATIONS

Siro is used to monitor and control temperature, humidity, CO₂, VOC and PM levels in offices, public spaces, meeting rooms and classrooms.

TECHNICAL DETAILS

Accuracy:	CO ₂ : ±33 ppm + 3 % of reading Relative humidity: ±2.4 % rH (typical at 20 °C, 3 % rH) Temperature: ±0.5 °C (typical at 20 °C) TVOC: ±15 % of reading typical PM: 0...100 µg/m ³ : PM2.5: ±15 µg/m ³ ; PM1.0, PM10: ±25 µg/m ³ 100...1000 µg/m ³ : PM2.5: ±15 %; PM1.0, PM10: ±25 % (at 25 °C ±5 °C)
Measuring units:	CO ₂ : ppm Relative humidity: % rH Temperature: °C VOC CO ₂ eq: ppm TVOC: ppm, µg/m ³ PM1/2.5/10: µg/m ³
Calibration (CO₂):	Automatic self-calibration, ABC Logic™
Supply voltage:	24 VDC/VAC ±10 %
Output signal 1-4:	0...10 V / 2...10 V / 0...5 V optional 4...20 mA linear to selected measurement (CO ₂ , VOC, PM, rH or Temp)
Operating temperature:	0...+50 °C
Protection standard:	IP20

SIRO

Example:	Product series
Siro-CO2-T-D	Siro Indoor air quality transmitter
	CO₂ sensor
	-CO2 With CO ₂ sensor (option not available with PM sensor)
	Without CO ₂ sensor
	VOC sensor
	-VOC With VOC sensor (option not available with PM sensor)
	Without VOC sensor
	PM sensor
	-PM With PM sensor (option not available with CO ₂ and VOC sensors)
	Without PM sensor
	Relative humidity sensor
	-rH With relative humidity sensor
	Without relative humidity sensor (option not available with VOC sensor)
	Temperature sensor
	-T With temperature sensor
	Without temperature sensor (option not available with VOC or rH sensor)
	Output
	Voltage output
	-A Voltage and current output
	Display
	-D With display
	Without display
Model	Siro -CO2 -T -D

SIRO-MOD INDOOR AIR QUALITY TRANSMITTERS

WITH MODBUS COMMUNICATION



SIRO-MOD

Siro-MOD is an indoor air quality transmitter with Modbus communication. Siro-MOD has a modern design and new hardware, including sensors. The transmitter is available with several optional air quality sensors including temperature, relative humidity, CO₂ concentration, VOC (Volatile Organic Compounds) and PM (Particulate Matter). It offers easy installation and adjustment, several different model options and various output signals that are configurable separately for each measurement parameter. Siro utilizes the industry standard NDIR measurement principle with self-calibrating ABC logic™ for CO₂ measurement.

USAGE & APPLICATIONS

Siro-MOD is used to monitor and control temperature, humidity, CO₂, VOC and PM levels in offices, public spaces, meeting rooms and classrooms.

TECHNICAL DETAILS

Communication:	RS-485 Modbus (RTU)
Accuracy:	CO ₂ : ±30 ppm + 3 % of reading Relative humidity: ±2.2 % rH (typical at 20 °C, 30 % rH) Temperature: ±0.4 °C (typical at 20 °C) TVOC: ±15 % of reading typical PM: 0...100 µg/m ³ : PM2.5: ±15 µg/m ³ ; PM1.0, PM10: ±25 µg/m ³ 100...1000 µg/m ³ PM2.5: ±15 %; PM1.0, PM10: ±25 % (at 25 °C ±5 °C)
Measuring units:	CO ₂ : ppm Relative humidity: % rH Temperature: °C VOC CO ₂ eq: ppm TVOC: ppm, µg/m ³ PM1/2.5/10: µg/m ³
Calibration (CO₂):	Automatic self-calibration, ABC Logic™
Supply voltage:	24 VDC/VAC ±10 %
Operating temperature:	0...+50 °C
Protection standard:	IP20

ALL VALUES ARE AVAILABLE
SIMULTANEOUSLY VIA MODBUS

SIRO-MOD

Example: Siro-MOD -PM-T-D	Product series					
	Siro	Indoor air quality transmitter				
	Model type					
	-MOD	With Modbus communication				
	CO₂ sensor					
	-CO2	With CO ₂ sensor (option not available with PM sensor)				
		Without CO ₂ sensor				
	VOC sensor					
	-VOC	With VOC sensor (option not available with PM sensor)				
		Without VOC sensor				
	PM sensor					
	-PM	With PM sensor (option not available with CO ₂ and VOC sensors)				
		Without PM sensor				
	Relative humidity sensor					
	-rH	With relative humidity sensor				
	Without relative humidity sensor (option not available with VOC sensor)					
Temperature sensor						
-T	With temperature sensor					
	Without temperature sensor (option not available with VOC or rH sensor)					
Output						
	Voltage output					
-A	Voltage and current output					
Display						
-D	With display					
	Without display					
Model	Siro	-MOD	-PM	-T	-D	

CMT CARBON MONOXIDE TRANSMITTER

SCREW FIXING MAKES REPLACING THE SENSOR EASY. THIS IS PARTICULARLY USEFUL WHEN THE DEVICE NEEDS CALIBRATING.



TECHNICAL DETAILS

Measuring unit:	ppm
Measuring range:	0...300 ppm CO
Measuring element:	Electro-chemical
Linearity:	≤2 % on 300 ppm CO
Cross sensitivity:	≤2 % on 300 ppm CO
Response time t90:	<60 s
Supply voltage:	14...28 VDC
Output signal:	4-20 mA (2-wire)
Operating temperature:	-10...+40 °C
Protection standard:	IP54

CMT

The CMT is an easy-to-use, reliable transmitter for detecting CO gas. It is commonly used in places where air includes CO gas, such as parking garages.

PRESSURE TRANSMITTERS FOR LIQUIDS

Pressure detection in liquids in heating and cooling systems. Also suitable for refrigerants and non-aggressive gases.



PTL-HEAT

PTL-Heat is used for pressure detection in non-condensing applications such as district heating or heat recovery systems.



PTL-COOL

PTL-Cool is designed for extreme conditions where condensation is a common problem. PTL-Cool has a two-layer protection for electronics. This is why the possible condensation does not harm the device. Suitable for plants that use refrigerants.



DPTL

The DPTL is made for differential pressure detection in liquids for air-conditioning, heating and water systems. The equipment can withstand mildly corrosive substances and liquids.

TECHNICAL DETAILS PTL-HEAT

Accuracy (from FS):	±1.0 %
Supply voltage:	15...24 VDC/VAC
Output signal:	0...10 V or 4...20 mA (2-wire)
Protection standard:	IP65, one-layer protection
Pressure connector:	inside thread G1/4"
Ambient temperature:	0...+105 °C, non-condensing
Temperature of medium:	0...+125 °C

TECHNICAL DETAILS PTL-COOL

Accuracy (from FS):	±1.0 %
Supply voltage:	15...24 VDC/VAC
Output signal:	0...10 V or 4...20 mA (2-wire)
Protection standard:	IP65, two-layer protection against condensation
Pressure connector:	inside thread G1/4"
Ambient temperature:	-40...+60 °C
Temperature of medium:	-40...+50 °C

PTL

Example: PTL-Heat-4-V	Product series		
	PTL	Pressure transmitter for liquids	
	Application		
	- Heat	For heating applications	
	- Cool	For cooling applications	
	Measuring range (bar)		
	-4	0...4 (PTL-Cool only on request)	
	-6	0...6	
	-10	0...10	
	-16	0...16 (PTL-Cool only on request)	
	-25	0...25 (PTL-Cool only on request)	
	Output		
	-V	Voltage	
	-A	Current (2-wire)	
Model	PTL	-Heat	-4

PTL-COOL HAS A TWO-LAYER PROTECTION FOR ELECTRONICS. THIS IS WHY THE POSSIBLE CONDENSATION DOES NOT HARM THE DEVICE.

TECHNICAL DETAILS DPTL

Accuracy (from FS):	±1.0 %
Supply voltage:	15...24 VDC/VAC
Output signal:	0...10 V or 4...20 mA (3-wire)
Protection standard:	IP65
Pressure connector:	inside thread G1/4"
Operating temperature:	-10...+80 °C

DPTL

Example: DPTL-2,5-V	Product series		
	DPTL	Differential pressure transmitter for liquids	
	Measuring range (bar)		
	-1	0...1	
	-2,5	0...2,5	
	-4	0...4	
	-6	0...6	
	Output		
	-V	Voltage	
	-A	Current (3-wire)	
Model	DPTL	-2,5	-V

PASSIVE TEMPERATURE SENSORS

PTE series passive temperature sensors are engineered for HVAC applications. The design approach has been to offer user-friendly and premium quality products with competitive pricing.

PTE products are available with the following sensor types and accuracies:

- NTC10k $\pm 0.25\text{ }^{\circ}\text{C}$ @ $25\text{ }^{\circ}\text{C}$
- NTC20k $\pm 0.25\text{ }^{\circ}\text{C}$ @ $25\text{ }^{\circ}\text{C}$
- Pt1000 $\pm 0.3\text{ }^{\circ}\text{C}$ @ $0\text{ }^{\circ}\text{C}$
- Ni1000 $\pm 0.4\text{ }^{\circ}\text{C}$ @ $0\text{ }^{\circ}\text{C}$
- Ni1000-LG $\pm 0.4\text{ }^{\circ}\text{C}$ @ $0\text{ }^{\circ}\text{C}$
- NTC1.8k $\pm 0.5\text{ }^{\circ}\text{C}$ @ $25\text{ }^{\circ}\text{C}$



PTE-DUCT



PTE-ROOM



PTE-CABLE



PTE-O



PTE-OI



PTE-I



PTE-FI



PTE-SF



PTE-FG

PASSIVE TEMPERATURE SENSORS FOR GAS



PTE-DUCT DUCT TEMPERATURE SENSOR

PTE-Duct is used to sense air temperature inside a ventilation duct. The temperature sensor is housed inside a stainless steel tube that protects it from the environment and condensation, ensuring long service life.



PTE-ROOM ROOM TEMPERATURE SENSOR

PTE-Room is used to sense air temperature indoors. The temperature sensor is housed in a modern white plastic housing. PTE-Room is particularly easy to install. The cover can be opened without tools and the cable can be routed from behind or above/below the installation surface. PTE-Room can be installed on top of a standard electrical switch box.

PTE-CABLE CABLE TEMPERATURE SENSOR

PTE-Cable senses temperatures in a wide range. It is well protected from the environment by its stainless steel sleeve which is crimped on to premium quality silicone rubber cable. Inside the sleeve, the temperature sensor is protected against condensation, ensuring long service life. The cable is halogen-free and oil resistant. PTE-Cable has a high protection rating of IP67.

TECHNICAL DETAILS PTE-DUCT

Operating temperature:	-50 ... +100 °C
Sensor tube length:	190 mm
Sensor tube outer diameter:	7 mm
Protection class:	IP54

**EASY INSTALLATION
WITH MOUNTING HOLES**

TECHNICAL DETAILS PTE-ROOM

Operating temperature:	-10 ... +50 °C
Housing dimensions:	85 x 85 x 27,5 mm
Protection class:	IP20

NEW HOUSING

TECHNICAL DETAILS PTE-CABLE

Operating temperature:	-60 ... +180 °C
Short-term temperature:	up to +250 °C
Materials:	Sleeve: Stainless steel Cable: Silicone rubber
Sleeve dimensions:	Outer diameter: 6 mm Length: 50 mm
Cable length:	2.0 m (Custom lengths available upon request)
Protection class:	IP67

**PTE-CABLE HAS A HIGH
PROTECTION RATING OF IP67**

PTE-DUCT / PTE-ROOM / PTE-CABLE

Example:	Product series		
	PTE-Duct-NTC10 PTE-Room-NTC10 PTE-Cable-NTC10	PTE	Passive temperature sensor for gas
	Installation type		
	-Duct	Duct	
	-Room	Room	
	-Cable	Cable	
	Sensor element		
	-NTC10	10 kΩ @ 25 °C	
	-NTC20	20 kΩ @ 25 °C	
	-Pt1000	1000 Ω @ 0 °C	
	-Ni1000	1000 Ω @ 0 °C	
	-Ni1000-LG	1000 Ω @ 0 °C	
	-NTC1.8k	1.8 kΩ @ 25 °C	
Model	PTE	-Duct	-NTC10
	PTE	-Room	-NTC10
	PTE	-Cable	-NTC10

PASSIVE TEMPERATURE SENSORS FOR GAS



PTE-0

OUTSIDE AIR TEMPERATURE SENSOR

PTE-0 is used to sense outside air temperature. The temperature sensor is hermetically sealed for protection.



PTE-OI

OUTSIDE AIR TEMPERATURE AND ILLUMINANCE SENSOR

PTE-OI is a combination of a passive temperature and an illuminance sensor. It is used to sense outside air temperature and ambient lighting conditions. In addition to the outside air temperature, the PTE-OI includes an ambient illuminance sensor. The illuminance sensor is hermetically sealed for protection.

TECHNICAL DETAILS PTE-0

Operating temperature: -50 ... +50 °C
 Protection class: IP54

TECHNICAL DETAILS PTE-OI

Operating temperature: -50 ... +50 °C
 Measuring range: 0...1000 lx
 Illuminance sensor accuracy: ±20 % @100 lx
 Protection class: IP54

PTE-0 / PTE-OI

Example: PTE-O-NTC10 PTE-OI-NTC10	Product series		
	PTE	Passive temperature sensor for gas	
	Installation type		
	-O	Outside	
	-OI	Outside with illuminance	
	Sensor element		
	-NTC10	10 kΩ @ 25 °C	
	-NTC20	20 kΩ @ 25 °C	
	-Pt1000	1000 Ω @ 0 °C	
	-Ni1000	1000 Ω @ 0 °C	
	-Ni1000-LG	1000 Ω @ 0 °C	
	-NTC1.8k	1.8 kΩ @ 25 °C	
Model	PTE	-O	-NTC10
	PTE	-OI	-NTC10

PASSIVE TEMPERATURE SENSORS FOR LIQUIDS

PTE-I IMMERSION SENSOR

PTE-I immersion sensor is used to sense the liquid temperature in pipes in HVAC systems. PTE-I needs to be installed into an immersion pocket.

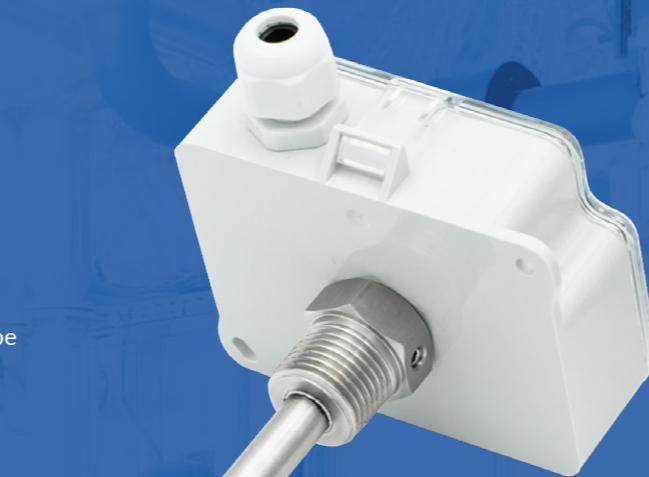

PTE-FI FAST RESPONSE IMMERSION SENSOR

PTE-FI immersion sensor is used to sense the liquid temperature in pipes in HVAC systems. PTE-FI is a fast response immersion sensor for liquid applications where fast response time is needed.



TECHNICAL DETAILS PTE-I

Operating temperature:	-50 ... +180 °C
Immersion length:	100 mm
Sensor tube outer diameter:	7 mm
Materials:	Sensor tube: Stainless steel SS316
Protection class:	IP54

TECHNICAL DETAILS IMMERSION POCKET

Operating temperature:	-50 ... +180 °C
Length:	100 mm
Outer diameter:	10 mm
Material:	Stainless steel SS316
Pressure rating:	PN40

TECHNICAL DETAILS PTE-FI

Operating temperature:	-50 ... +120 °C
Sensor tube length:	85 mm
Sensor tube outer diameter:	4 mm
Material:	Stainless steel SS316
Pressure rating:	PN40
Protection class:	IP54

**EASY INSTALLATION
WITH MAGNETIC
FASTENING
(PATENT PENDING)**

PTE-I / PTE-FI

Example: PTE-I-NTC10 PTE-FI-NTC10	Product series		
	PTE	Passive temperature sensor for liquids	
	Installation type		
	-I	Immersion	
	-FI	Fast response immersion	
	Sensor element		
	-NTC10	10 kΩ @ 25 °C	
	-NTC20	20 kΩ @ 25 °C	
	-Pt1000	1000 Ω @ 0 °C	
	-Ni1000	1000 Ω @ 0 °C	
	-Ni1000-LG	1000 Ω @ 0 °C	
	-NTC1.8k	1.8 kΩ @ 25 °C	
Model	PTE	-I	-NTC10
	PTE	-FI	-NTC10

PASSIVE TEMPERATURE SENSORS FOR LIQUIDS

PTE-SF SURFACE SENSOR

PTE-SF immersion sensor is used to sense the liquid temperature in pipes in HVAC systems. PTE-SF is easy to install and does not need immersion pocket to sense pipe temperature.



PTE-FG FROST GUARD SENSOR

PTE-FG frost guard sensor is used to sense the liquid temperature in radiators and pipes in HVAC systems. PTE-FG is a fast response sensor for protecting radiators from freezing.

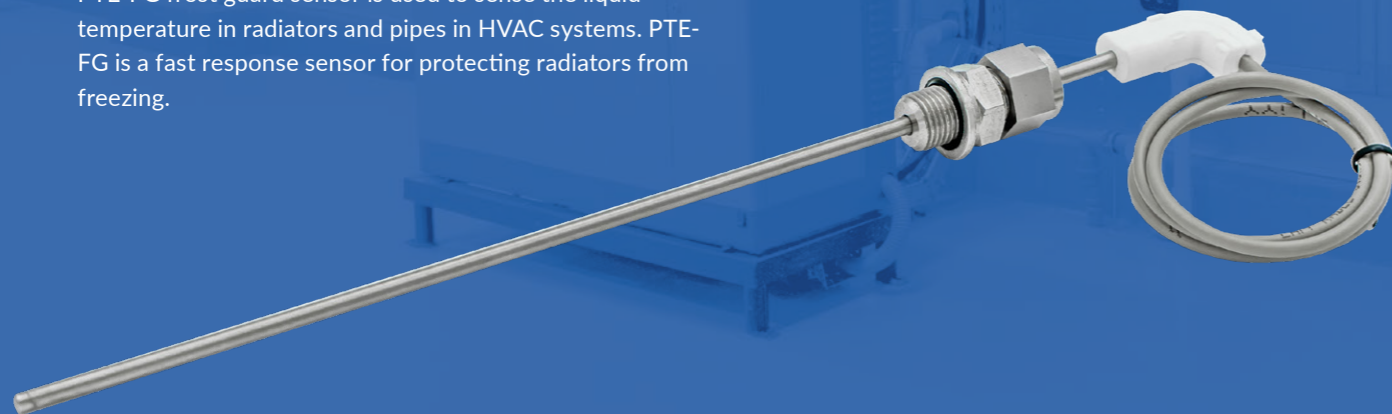

TECHNICAL DETAILS PTE-SF

Operating temperature:	-50 ... +80 °C
Short-term temperature:	up to +150 °C
Materials:	Sleeve: Stainless steel Cover: PA2200 Cable: Silicone rubber
Sleeve dimensions:	Outer diameter: 6 mm Length: 50 mm
Cable length:	2.0 m (Custom lengths available upon request)
Protection class:	IP67

**FAST AND EASY
INSTALLATION –
NO TOOLS NEEDED**

TECHNICAL DETAILS PTE-FG

Operating temperature:	-50 ... +120 °C
Materials:	Housing: ABS Cover: PC Sensor tube: Stainless steel SS316
Dimensions:	Sensor tube outer diameter: 4 mm Sensor tube length: 300 mm
Pressure rating:	PN40
Protection class:	IP54

**EASY TO INSTALL
EVEN IN NARROW
SPACES BECAUSE
OF THE L-BEND**

PTE-SF / PTE-FG

Example: PTE-SF-NTC10 PTE-FG-NTC10	Product series		
	PTE	Passive temperature sensor for liquids	
	Installation type		
	-SF	Surface (strap-on)	
	-FG	Frost guard	
	Sensor element		
		-NTC10	10 kΩ @ 25 °C
		-NTC20	20 kΩ @ 25 °C
		-Pt1000	1000 Ω @ 0 °C
		-Ni1000	1000 Ω @ 0 °C
		-Ni1000-LG	1000 Ω @ 0 °C
		-NTC1.8k	1.8 kΩ @ 25 °C
Model	PTE	-SF	-NTC10
	PTE	-FG	-NTC10

DPG

DIFFERENTIAL PRESSURE GAUGE



TECHNICAL DETAILS

Accuracy (from FS):	< ±2 % (DPG60 < ±4 % ; DPG100 < ±3 %)
Operating temperature:	-5...+60 °C
Zero point adjustment screw:	external in the plastic cover
Mounting:	surface mounting or flush mounting
Mounting position:	vertical

Product	Measuring range
DPG60	0-60 Pa
DPG100	0-100 Pa
DPG120	0-120 Pa
DPG200	0-200 Pa
DPG250	0-250 Pa
DPG300	0-300 Pa
DPG400	0-400 Pa
DPG500	0-500 Pa
DPG600	0-600 Pa
DPG800	0-800 Pa
DPG1K	0-1 kPa
DPG1.5K	0-1.5 kPa
DPG2K	0-2 kPa
DPG3K	0-3 kPa
DPG5K	0-5 kPa

DPG

DPG is a standard pressure gauge for measuring overpressure and differential pressure.

USAGE

DPG is used to measure low pressures of air and non-combustible gases mainly in HVAC systems.

APPLICATIONS

- monitoring filters and ventilators
- monitoring overpressure and pressure difference in air ducts, air handling units, cleanrooms and laminar flow cabinets

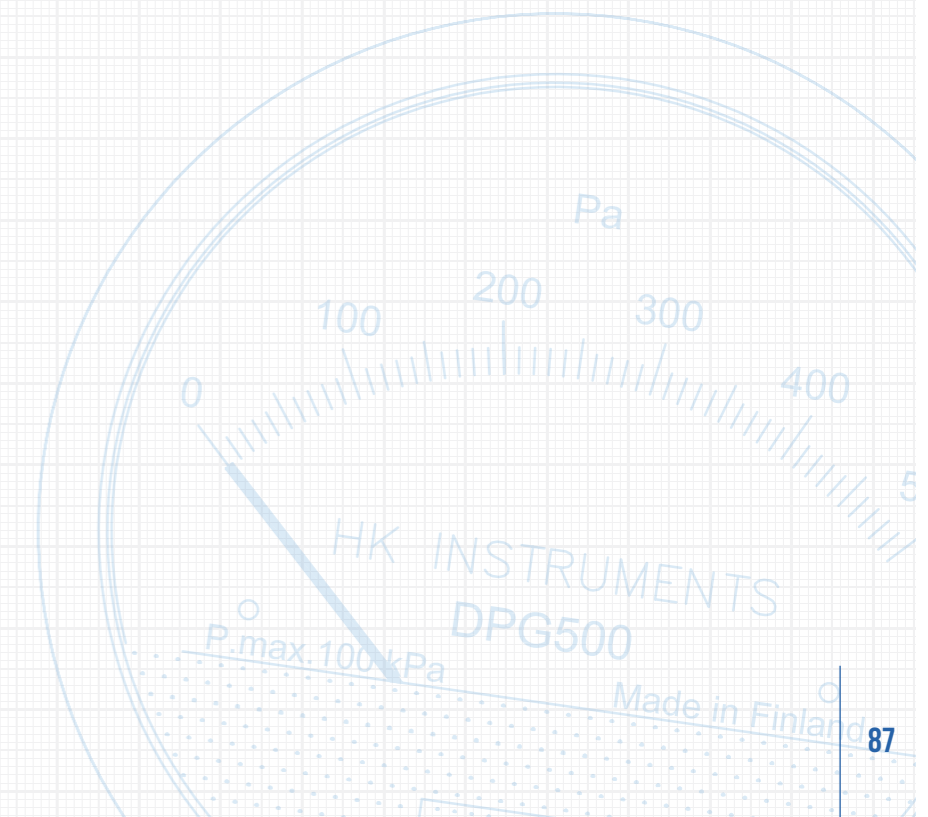

LIQUID COLUMN MANOMETERS



MM

Reliable inclined column manometer with leakage protection system



MMU

Traditional U-tube manometer with easy zero point calibration

Liquid column manometers are reliable and inexpensive traditional pressure meters. The manometers are good for measuring and indicating small overpressure, vacuum and differential pressure of air and non-aggressive gases in low pressure ranges.

Liquid column manometers are ideal for general-purpose work in air-conditioning and ventilation, monitoring of air filters for contamination and monitoring of air flow and air velocity.

MM

Product	Measuring range	Accuracy
MM±100500*)	-100...100...500 Pa	2 Pa/25 Pa
MM200600	0...200...600 Pa	5 Pa/25 Pa

*) Delivered with level bubble.

Optional level bubble is available to MM200600 on request!

MMU

Product	Measuring range	Accuracy
MMU±500	±500 Pa	10 Pa

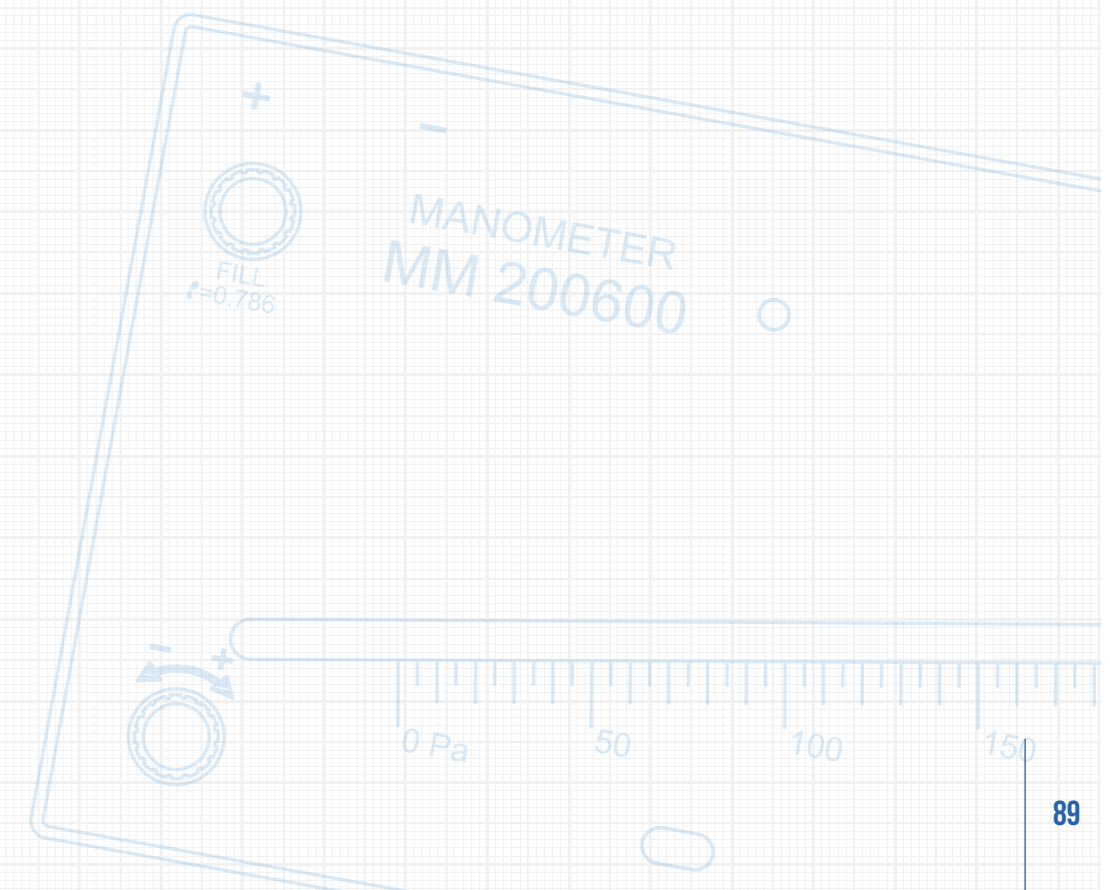

YM-3 OVERPRESSURE METER FOR CIVIL DEFENCE AND MILITARY SHELTERS

PROTECTED
AGAINST BLAST
SHOCK AND
STATIC PRESSURE
LOADS

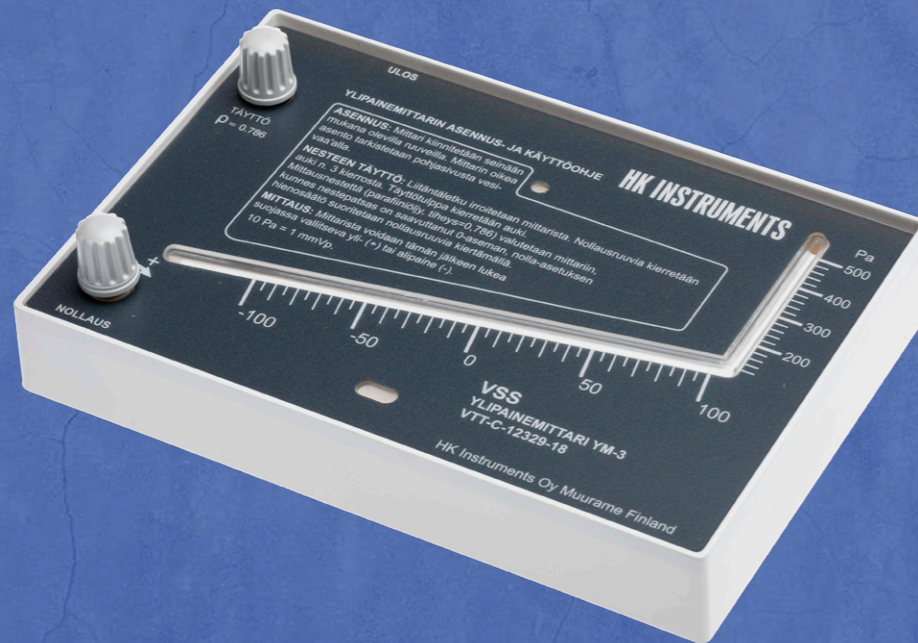

TECHNICAL DETAILS

Accuracy (MM±100500):	-100...100 Pa ±5 Pa 100...500 Pa ±25 Pa
Overpressure:	Static pressure -20...300 kPa
Measurement ranges:	-100...100...500 Pa
Safety:	Withstands rapid change in velocity 2.5 m/s, 30 g Withstands vibration with acceleration of 2.5 m/s, 30 g Protected against blast shock and static pressure loads Certificate VTT-C-12329-18 granted by VTT / Technical Research Centre of Finland

CERTIFIED BY VTT / TECHNICAL RESEARCH
CENTRE OF FINLAND



YM-3

The YM-3 overpressure meter is designed and tested to withstand strong blast loadings exerted on the meter through its connection pipe. YM-3 is type-tested and approved by the Technical Research Centre of Finland / VTT that performs type inspecting mandated by the Finnish Ministry of the Interior.

USAGE & APPLICATIONS

Measures and monitors overpressure in civil defence and military shelters.

PS DIFFERENTIAL PRESSURE SWITCH



TECHNICAL DETAILS

Accuracy of switching point (low limit typ.):	±5 Pa (PS1500: ±20 Pa, PS4500: ±100 Pa)
Accuracy of switching point (high limit typ.):	PS200: ±20 Pa, PS300 & PS500: ±30 Pa, PS600 & PS1500: ±50 Pa, PS4500: ±200 Pa
Service life:	over 1 000 000 switching operations
Electrical rating (resistive load):	3 A / 250 VAC (PS200: 0.1 A / 250 VAC)
Electrical rating (inductive load):	2 A / 250 VAC (PS200: --)
Operating temperature:	-20...+60 °C
Protection standard:	IP54

Product	Measuring range
PS200	20...200 Pa
PS300	30...300 Pa
PS500	30...500 Pa
PS600	40...600 Pa
PS1500	100...1500 Pa
PS4500	500...4500 Pa

PS

PS is a robust, easy-to-use differential pressure switch for air and non-combustible gases.

USAGE

The pressure switches are used in ventilation and air-conditioning systems to monitor changes in overpressure, vacuum and differential pressure.

APPLICATIONS

- monitoring filters and fans
- monitoring vacuum and overpressure in air ducts
- controlling defrosting functions

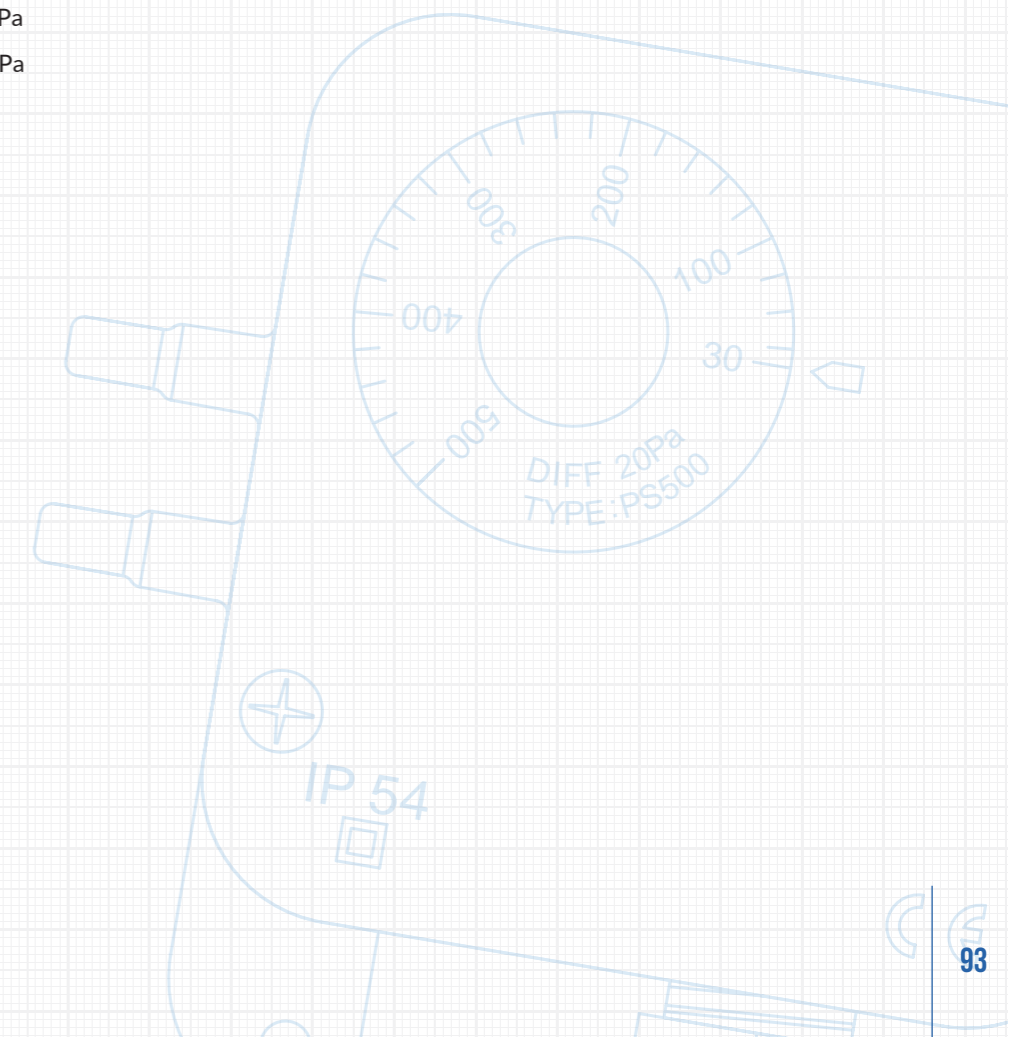

FILTER ALERTS

The filter alerts are a solution for systems requiring visual indication of pressure on site, together with a switching point signal. The filter alerts are ideal for general-purpose work in air-conditioning and ventilation, especially in monitoring of air filters for contamination.

The available combinations include pressure gauge and pressure switch combination (DPG/PS), and inclined tube manometer and pressure switch combination (MM/PS).

MM/PS

Product	MM range	PS range
MM200600/PS600	0... 600 Pa	40...600 Pa

DPG/PS

Product	DPG range	PS range
DPG200/PS200	0... 200Pa	20...200 Pa
DPG600/PS600	0... 600 Pa	40...600 Pa
DPG1,5K/PS1500	0...1500 Pa	100...1500 Pa

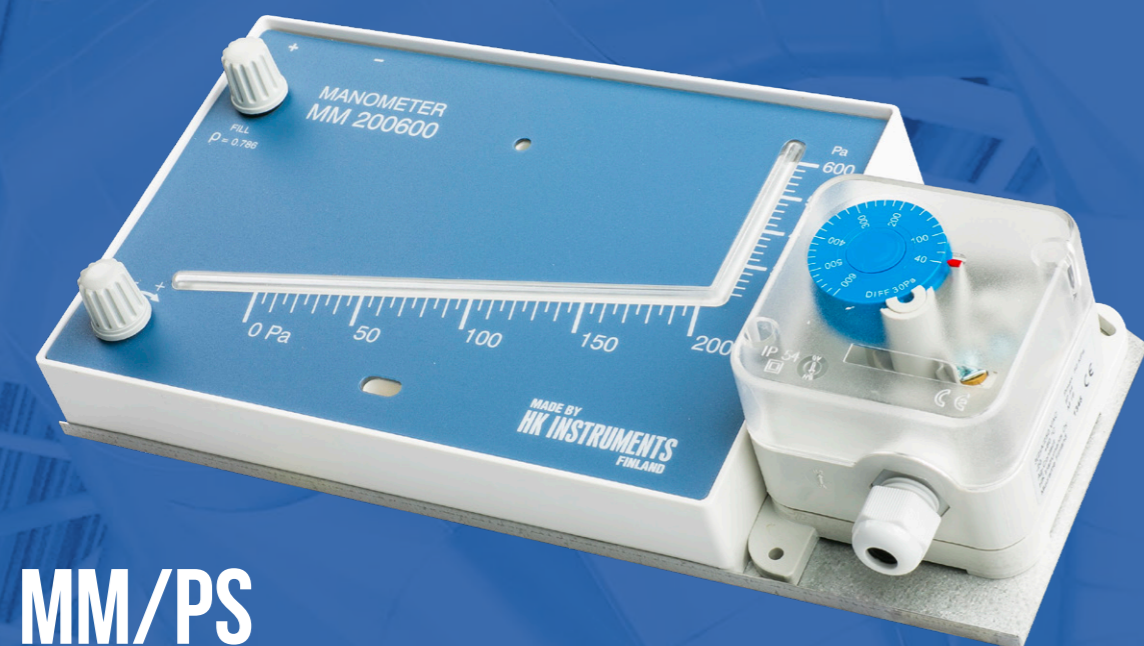

MM/PS



DPG/PS

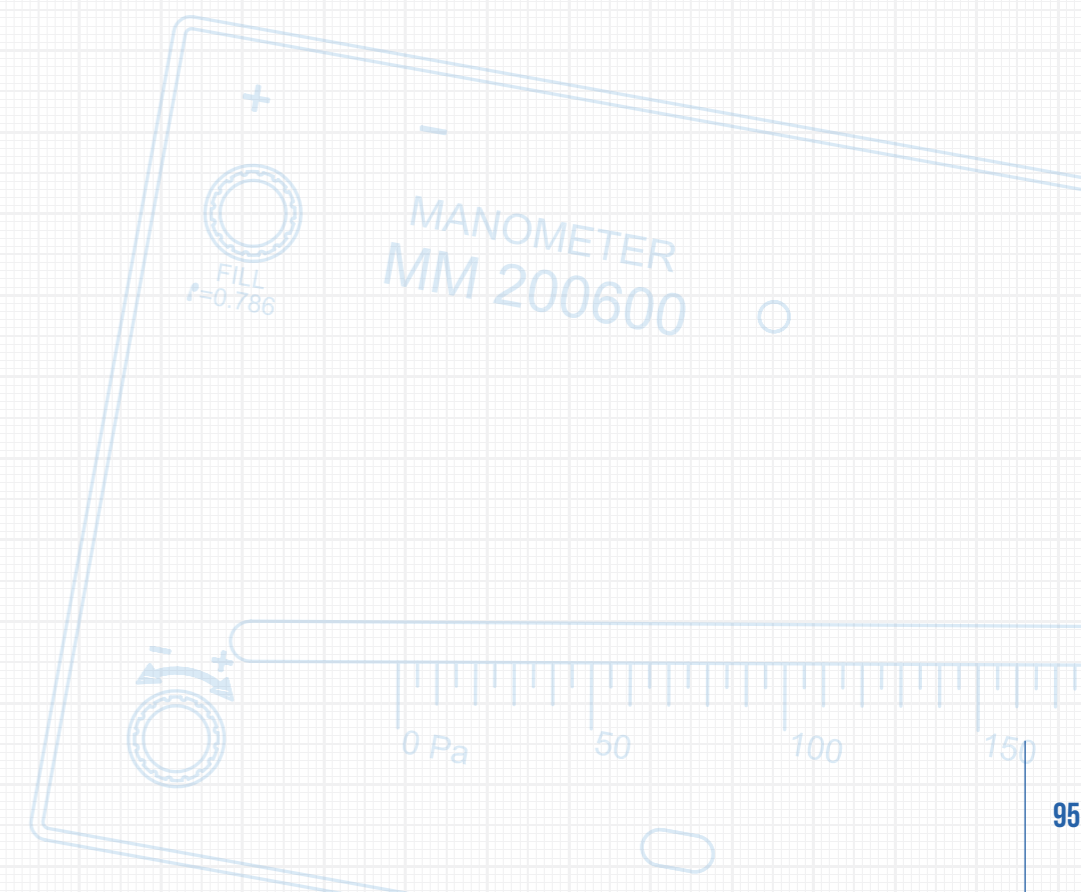

PHM-V1 MICROMANOMETER

HANDHELD INSTRUMENT FOR MEASURING AIR PRESSURE
AND AIR FLOW

COMPLETE FIELD
INSTRUMENT FOR HVAC
VENTILATION BALANCING
AND DIAGNOSTICS



TECHNICAL DETAILS

Range:	-250...2550 Pa
Maximum overpressure:	30 kPa
Accuracy:	± 1.4 % from applied pressure
USB:	Mini B
Units on display:	Pressure: Pa, mmH ₂ O, inchWC, mbar Flow: l/s, m ³ /h, m ³ /s
Operating temperature:	-10 ... +50 °C

Can be used with pitot tube

Preprogrammed valve manufacturers include for example:

- EH-Muovi
- Fläkt Woods
- Halton
- Lindab
- Climecon
- Swegon
- Uponor

Save time and reduce human error with a preprogrammed K-factor database.

PHM-V1 Manager software allows you to upload measuring results, add new ventilation valve data and create documentations efficiently on your computer.

PHM-V1 is delivered in a handy case containing a calibration certificate, ventilation valve measurement kit, PHM-V1 manager software etc.

PHM-V1

PHM-V1 micromanometer is a handheld instrument for measuring air pressure and air flow. Its patented technology includes over 1000 preprogrammed ventilation valve and diffuser K-factor databases. This feature allows measuring without manual calculations or knowing the manufacturer's K-factors. Over 500 measuring results can be saved and then downloaded to PHM-V1 Manager computer software for documentations.

APPLICATIONS

- Air flow and pressure measurements from air diffusers, ventilation valves, dampers and grilles
- Measuring room-to-room pressures or across the building envelope
- In-duct measurements with pitot tube
- Measuring pressure drop across the filter
- Fan flow measurement
- Cleanroom air flow measurements

ACCESSORIES

TUBES AND EXTENSIONS



PVC tube 4/7 matt, 2 m



PVC tube 4/7 matt, 100 m coil



T-connector for d=4 mm tube
L-connector for d=4 mm tube
Connector extension for d=4 mm tube

MOUNTING



Accessory pack (tube, duct connectors, screws)

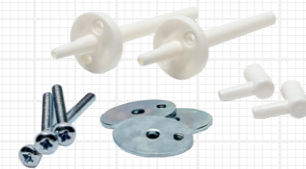

Accessory pack for DPG flush mounting



PTL adapter G1/4"-G1/2"



Duct connector, plastic, for d=4 mm tube (80 mm)



Duct connector, metallic, for d=4 mm tube (40 mm)



Duct connector, metallic, for d=4 mm tube (100 mm)



DPTL mounting plate



Mounting flange for duct sensors

MANOMETER LIQUIDS



Gauge fluid 0,786; 30 ml (red)
Gauge fluid 0,786; 250 ml (red)
Gauge fluid 1,870; 30 ml (blue)

THERMOMETERS



Thermometer 0...+60 °C

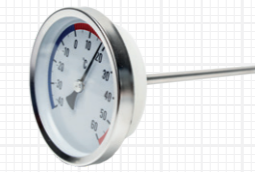

Thermometer -40...60 °C

OTHER ACCESSORIES



Display upgrade kit (DPT & DPT-Flow)

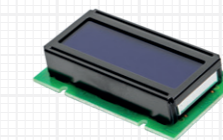

Digital display, blue (DPT & DPT-Flow)

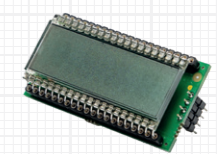

4-digit, green/black display (2W, AVT)



DPT cover with front label



Static pressure port

HK INSTRUMENTS

USER-FRIENDLY MEASURING DEVICES

HK Instruments is a Finnish company specialized in manufacturing and developing technologically advanced measuring devices for HVAC applications. Our devices are primarily used in air handling systems and building automation.

Over 30 years of experience and exports to more than 45 countries prove our high-class product development and cost-effective manufacturing. We have invested in practical user interfaces and that is why the installation of our devices is extremely easy and fast.

HK INSTRUMENTS

Keihästie 7
FIN-40950 MUURAME
FINLAND

Phone. +358 14 337 2000
Fax. +358 14 337 2020

info@hkinstruments.fi
www.hkinstruments.fi

