



SAFETY AUTOMATION MEASUREMENT AND CONTROL

Short Form Catalog

CONTENTS

SAFETY SENSORS

• EOS4	Type 4 light curtains	Page 2
• ADMIRAL	Type 4 light curtains	Page 4
• JANUS	Type 4 light curtains	Page 6
• EOS2	Type 2 light curtains	Page 10
• VISION	Type 2 light curtains	Page 12
• MAGNUS	PLd/PLe magnetic switches and control unit	Page 15
• ILION, ULISSE	Type 2 photocells and control units	Page 20
• PHARO	Type 3 laser scanner	Page 21

SAFETY INTERFACES AND CONTROLLERS

• MOSAIC	SIL 3 Modular safety integrated controller	Page 16
• AD SR	Safety Interfaces	Page 18

SENSORS

• METRON	Sensors for measurement, automation and control	Page 22
-----------------	---	---------

ACCESSORIES

• WTF/WTHF	IP 69K Watertight enclosure	Page 24
• FMC	Floor mounting columns	Page 24
• SP	Deflection mirrors	Page 25
• LAD	Laser alignment devices	Page 25
• SAV	Vibration dampers	Page 25
• SFB	Swivel fixing brackets	Page 25

INTRODUCTION

This *Short Form* catalog illustrates our product range in clear, straightforward format. For more in-depth information, please consult our full catalog containing detailed data on all products plus a useful Safety Guide.

Full details are also available on www.reer.it.

However, the *Short Form* Catalog contains all basic data on all our product lines.

In addition to safety optoelectronic sensors the catalog lists a comprehensive line of light curtains for measurement applications, safety magnetic sensors and an increasingly popular range of safety interfaces, in particular the innovative MOSAIC line of configurable safety controllers.

ReeR is leader in Italy and one of the top operators internationally in the field of safety-related equipment.

For over half a century – we celebrated our 50th anniversary in 2009 – ReeR has been active in the industrial automation sector and is the industry standard for those demanding safety in their work environment.

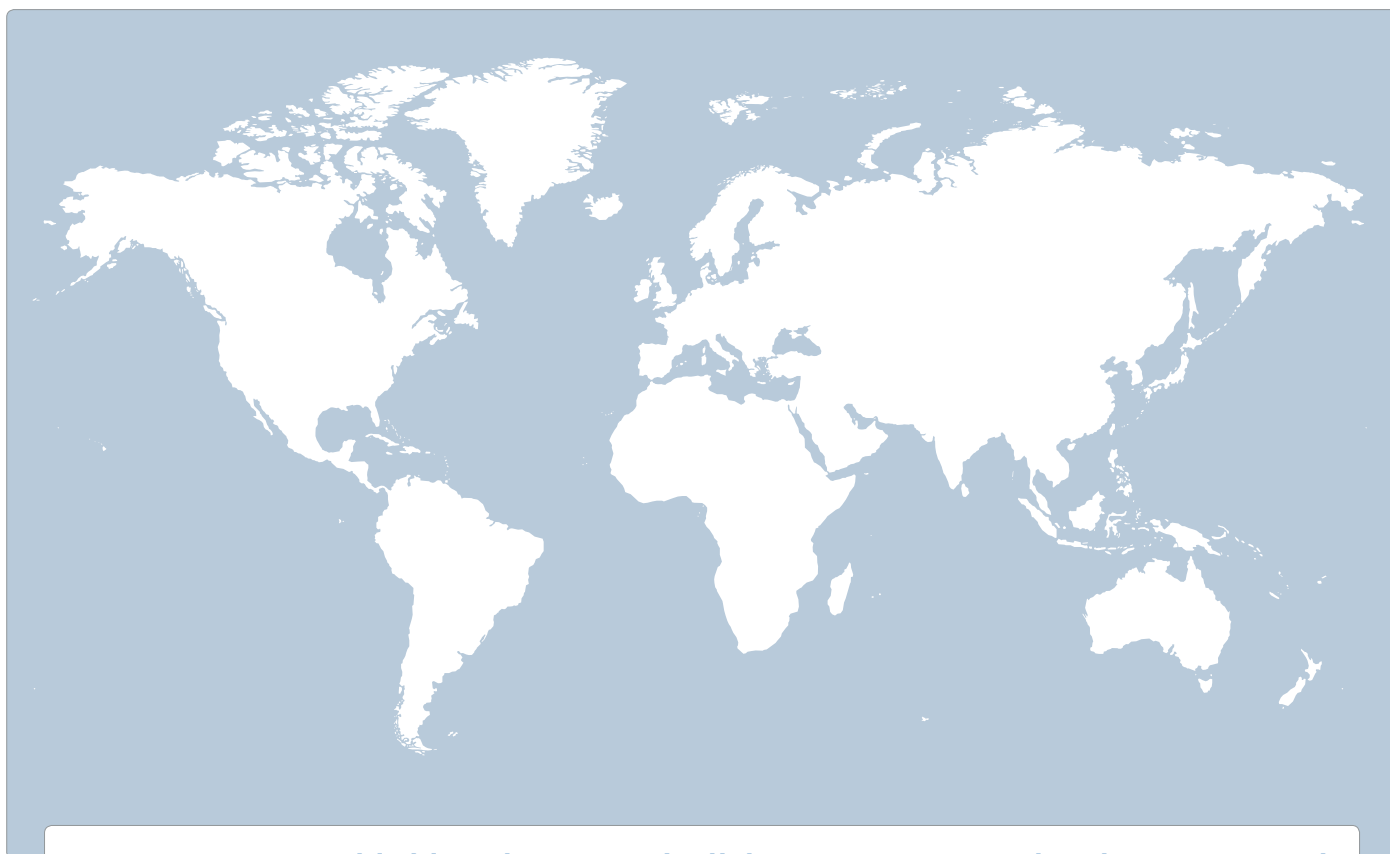

To see ReeR's worldwide sales network click on ReeR International on www.reer.it

EOS4

EOS4 is a compact Type 4 light curtain with competitive performance and innovative features.

Its features include:

- Minimal cross section - 28 x 30 mm.
- No blind area on one side:
position of first beam ensures that the sensitive area extends to end of the light curtain.
- The solution with two L-mounted light curtains, e.g. Master-Slave, maintains 40 mm resolution (hand detection) in corner (models with resolution up to 40 mm).
- Minimal blind area on connector side.
- Easy connection and installation thanks to the M12 connectors and the use of unshielded cables up to 100 m.
- Integrated safety functions, including self-monitoring of static outputs, control of external contactors (EDM) and automatic/manual selectable Restart.
- Exceptional mechanical and electrical robustness are the result of extensive experience gained hands-on with all kinds of applications.
- Operating temperature range -10 to 55 °C.
- Protection rate: to IP 65 and IP 67 at the same time
High resistance to infiltration by dust and liquids in a highly compact light curtain.
- Models Master/Slave for cascade connection of two or three light curtains.
- 2 safety PNP static outputs.

Special versions with IP 69K watertight enclosure (WTF and WTHF), also suitable for Food & Beverage industry, available.

Models in conformity with the "ATEX Directive" 94/9/CE - Dust Zone 22 - Gas Zone 2 available on request.

EOS4 light curtains may be connected to the dedicated safety interfaces series AD SR, or directly to contactors actuated and controlled by the light curtain, or to MOSAIC or to suitable commercial safety modules or safety PLCs.

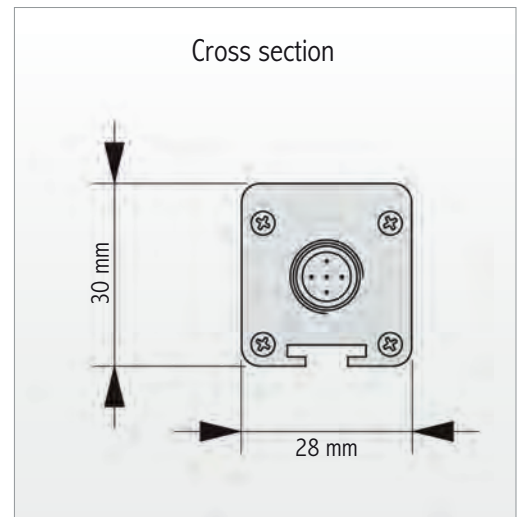
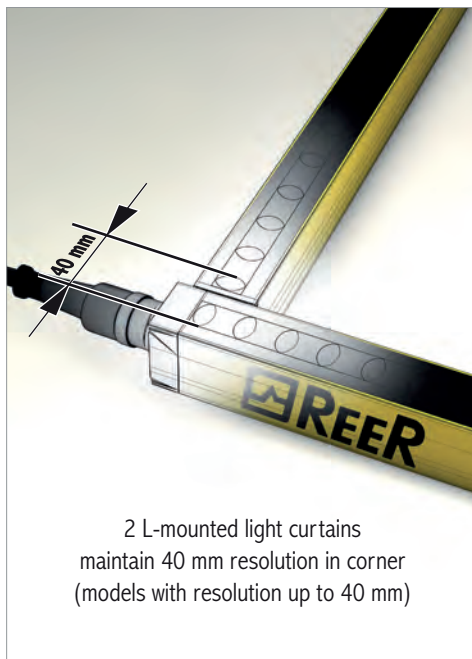

Safety level:
TYPE 4
SIL 3 – SILCL 3 PL e – Cat. 4



THE EOS4 RANGE

EOS4 A

- Protected height range 160 to 1510 mm
- 7 types of detection:
 - Resolution 14 mm for finger detection
 - Resolution 20 - 30 - 40 mm for hand detection
 - Resolution 50 - 90 mm for detection of the body in a dangerous area
 - 2 - 3 - 4 beams for detection of the body in access monitoring
- Max range 12 m and 20 m for H models (6 m for 14 mm resolution)
- 2 safety static outputs PNP with auto-test protected against short circuits and overloads
- Automatic Start/Restart
- M12, 5-pole connectors.

The ideal light curtain for straightforward interfacing with safety modules or safety PLCs.

EOS4 X

- Protected height range 160 to 1510 mm
- 7 types of detection:
 - Resolution 14 mm for finger detection
 - Resolution 20 - 30 - 40 mm for hand detection
 - Resolution 50 - 90 mm for detection of the body in a dangerous area
 - 2 - 3 - 4 beams for detection of the body in access monitoring
- Max range 12 m and 20 m for H models (6 m for 14 mm resolution)
- M12, 5-pole connector for emitter and M12, 8-pole for receiver
- Integrated, selectable manual or automatic Start/Restart
- Feedback input for external relay monitoring (EDM)
- Master and Slave models for series connection of two or three light curtains regardless of height or resolution.

An effective light curtain for directly controlling and monitoring machine circuits with no need of external safety modules.

Master/Slave models are also ideal for series connection of several light curtains and combined detection of hand and body or the protection of two different sides of a machine.

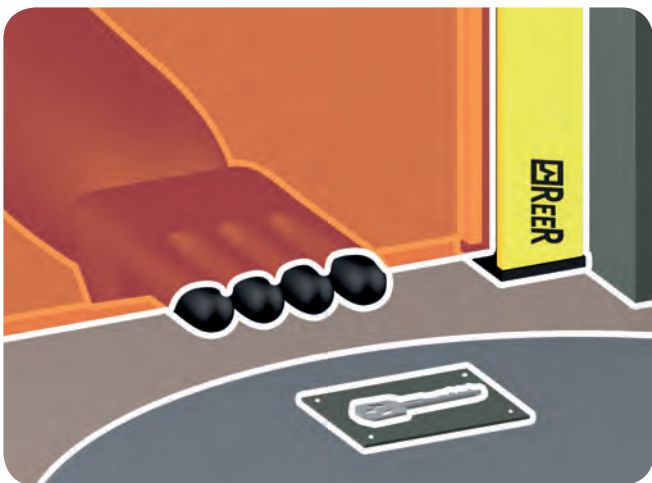

The protected area extends until the light curtain end maintaining the resolution



The resolution is maintained (up to 40 mm) in the junction between the 2 protected areas

ADMIRAL

Type 4 Safety light curtains providing:

- Easy connection and installation thanks to the M12 connectors and the use of unshielded cables up to 100 m.
- Built-in main safety functions.
- 2 safety PNP static outputs.
- Master/Slave Models for cascade connection of two light curtains.
- Models with Floating Blanking.
- Models with 2, 3 and 4 beams Long Range, max 60 meters.
- IP 65 protection rate.
- Operating temperature range: 0 to 55 °C.
- Cross section 35 x 45 mm.

Admiral light curtains may be connected to the dedicated safety interfaces series AD SR, or directly to contactors actuated and controlled by the light curtain, or to MOSAIC, or to suitable commercial safety modules or safety PLCs.

Special versions with IP 67 watertight enclosure (WT and WTH) available.



THE ADMIRAL RANGE

ADMIRAL AD

- Protected height range 160 to 1810 mm
- 7 types of detection:
 - Resolution 14 mm for finger detection
 - Resolution 20 - 30 - 40 mm for hand detection
 - Resolution 50 - 90 mm for detection of the body in a dangerous area
 - 2 - 3 - 4 beams for detection of the body in access monitoring
- Max range 18 m (5 m for 14 mm resolution)
- M12, 5-pole connectors
- Automatic Start/Restart.

The ideal light curtain for straightforward interfacing with safety modules or safety PLCs.

ADMIRAL AX

- Protected height range 160 to 1810 mm
- 7 types of detection
 - Resolution 14 mm for finger detection
 - Resolution 20 - 30 - 40 mm for hand detection
 - Resolution 50 - 90 mm for detection of the body in a dangerous area
 - 2 - 3 - 4 beams for detection of the body in access monitoring
- Max range 18 m (5 m for 14 mm resolution)
- M12, 5-pole connector for emitter and M12, 8-pole for receiver
- Integrated, selectable manual or automatic Start/Restart
- Feedback input for external relay monitoring (EDM)
- Master and Slave models for series connection of two light curtains regardless of height or resolution.

Safety level:

TYPE 4

**SIL 3 – SILCL 3
PL e – Cat. 4**



An effective light curtain for directly controlling and monitoring machine circuits with no need of external safety modules.

Master/Slave models are also ideal for series connection of two light curtains and combined detection of hand and body or the protection of two different sides of a machine.

ADMIRAL

ADMIRAL AX LR Long Range

- 2 - 3 - 4 beams for detection of the body in access monitoring
- Max range 60 m
- M12, 5-pole connector for emitter and M12, 8-pole for receiver
- Integrated, selectable manual or automatic Start/Restart
- Feedback input for external relay monitoring (EDM).

Ideal light grid for large size protection applications, also on several sides using deflection mirrors.

ADMIRAL AX LR DB [NEW PRODUCT]

This special version of the Admiral Long Range features an innovative Dual Beam System useful in outdoor applications or in harsh environments for decreasing the sensitivity of the light curtain to small objects that could interrupt the light link, i.e. birds or leaves but also heavy rain or snow.

Available models with 2 - 3 beams for detection of the body in access monitoring, max. range 80 m.

Available with heated IP 67 WTH case for outdoor use.

**ADMIRAL AX BK**

- Protected height range 160 to 1810 mm.
- 4 types of detection:
 - Resolution 14 mm for finger detection
 - Resolution 20 - 40 mm for hand detection
 - Resolution 90 mm for detection of the body in a dangerous area
- Max range 18 m (5 m for 14 mm resolution)
- M12, 5-pole connector for emitter and M12, 8-pole for receiver
- Automatic Start/Restart
- Integrated Floating Blanking, 5 selectable configurations
- Master and Slave models for series connection of two light curtains regardless of height or resolution.

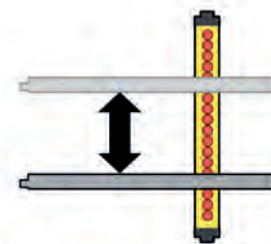

Admiral AX BK light curtains are equipped with Floating Blanking function, allowing object to move freely in guarded field, provided that the obstructed beams are adjacent and their number does not exceed that envisaged by design configuration.

Ideal light curtain for protection of press brakes, automated machines and robotized areas, where processing involves cross-over of light curtain-guarded space by material being processed or by machine moving parts.

Blanking models with 14 and 20 mm resolution are also available with Master/Slave function (on Master models only) as a protection system including two series-connected light curtains for combined detection of hand and body or the protection of two sides of a machine.

JANUS

Type 4 safety light curtains and grids, robust and integrated.
The range comprises Janus M with Muting and Janus J without Muting function.

The Janus range includes models TRX with one active element and one passive retro-reflecting element which does not require electrical connections.

Janus M and M TRX are also available with built-in muting sensors.

Main features:

- Set-up of each function can be done through main connector
No need for configuration via software
- Built-in main safety functions
- 2 safety PNP static outputs
- Automatic or manual Start/Restart
- Feedback input for controlling external relays (EDM)
- Built-in Muting function on models MI
- Built-in Muting sensors on models ML and MT
- Integrated Override with two selectable operating modes
- Muting Time-out 30 sec, 90 min or infinite
- Input Muting enable available on models M TRX
- M12 and M23 connectors
- IP 65 protection rate
- Operating temperature range -10 to 55 °C
- Cross section 50 x 60 mm



Safety level:

TYPE 4

SIL 3 – SILCL 3
PL e – Cat. 4

THE JANUS RANGE

JANUS M and JANUS M TRX with built-in Muting function

- Janus MI and MI TRX with connectors for external sensors of any type
- Janus MI TRXL with single connector for all connections, including external sensors
- Janus ML and ML TRX and Janus MT and MT TRX featuring an innovative horizontal arm system with built-in Muting photoelectric sensors, prewired and prealigned
- Janus ML TRX G and Janus MT TRX G (Glass) with special built-in muting sensors to optimize correct and consistent detection of glass and transparent materials in general.

JANUS MI

- Dedicated connections for external Muting sensors of any type through M12 connectors
- Muting logics both two-way entry/exit (2 – 4 sensors) and one-way exit only (2 sensors)
- Protected height range 310 to 1810 mm, resolution 40 and 90 mm (310 to 1210 for resolution 30 mm)
- 4 types of detection:
 - Resolution 30 - 40 mm for hand detection
 - Resolution 90 mm for detection of the body in a dangerous area
 - 2 - 3 - 4 beams for detection of the body in access monitoring
- Max range 16 m (60 m for Long Range versions).

**JANUS ML**

Janus ML has an original 2-horizontal arms system – one for the Emitter and one for the Receiver – with built-in Muting photoelectric sensors, prewired and prealigned.

- One-way Muting logics, exit only
- 2 and 3 beams for detection of the body in access monitoring
- Max range 2,5 m (2 m ML_S2)
- Optoelectronic Muting sensors with 2 crossed beams (models ML) and parallel beams (models ML_S2).

**JANUS MT**

Janus MT has an original 4-horizontal arms system – 2 for the Emitter and 2 for the Receiver – with built-in Muting photoelectric sensors, prewired and prealigned.

- Two-way Muting logics, entry/exit
- 2 and 3 beams for detection of the body in access monitoring
- Max range 2,5 m (2 m MT_S4)
- Optoelectronic Muting sensors with 2 crossed beams (models MT) and 4 parallel beams (models MT_S4).



JANUS

JANUS MI TRX, MI TRXL

Janus MI TRX and MI TRXL consist of one active emitter/receiver element and one retro-reflecting passive element which does not need electrical connections.

- Models MI TRX with M12 front connectors for external Muting sensors with 2 or 4-sensor logics for both two-way entry/exit (2 – 4 sensors) and one-way (2 sensors) exit only.
- Models MI TRXL with single connector M23 with 2-sensor logics for two-way entry/exit (2 sensors)
- 2 - 3 - 4 beams for detection of the body in access monitoring
- Max range 6 m.

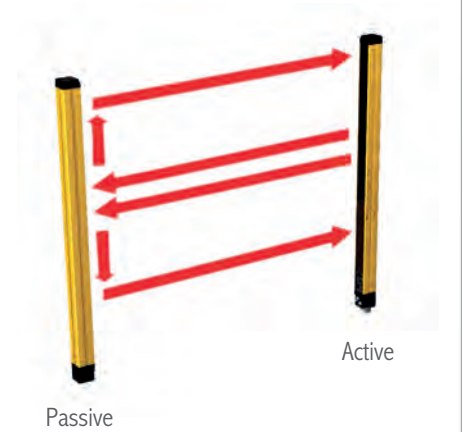

JANUS ML TRX, ML TRX G, ML TRX V

Janus ML TRX and ML TRX G, 2 or 3 beams for access monitoring have an original 2-horizontal arms system – one for active side and one for passive side – with built-in Muting photoelectric sensors, prewired and prealigned.

Models ML TRX G are designed to ensure reliable detection of glass and other transparent materials.

Both light grid and Muting sensors consist of one active emitter/receiver element and one retro-reflecting passive element which does not need electrical connections.

- One-way Muting logics, exit only
- 2 and 3 beams for detection of the body in access monitoring
- Max range 3,5 m models TRX (2 m TRX G)
- Optoelectronic Muting sensors with 2 parallel beams.

ML TRX V with longer built-in muting arms available for high-speed conveyors.

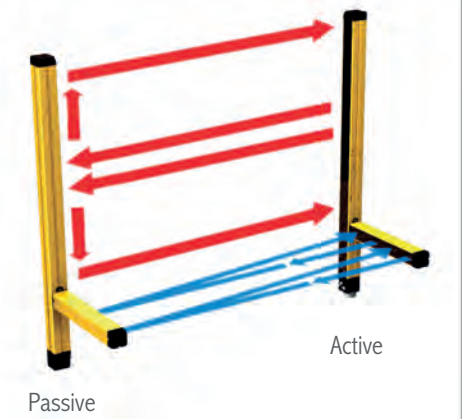

JANUS MT TRX, MT TRX G, MT TRX V

Janus MT TRX and MT TRX G, 2 or 3 beams for access monitoring have an original 4-horizontal arms device (2 for active side and 2 for passive side) with built-in Muting photoelectric sensors, prewired and prealigned.

Models MT TRX G are designed to ensure reliable detection of glass and other transparent materials.

Both light grid and Muting sensors consist of one active sensor emitter/receiver and one retro-reflecting passive sensor which does not need electrical connections.

- Two-way Muting logics, entry/exit
- 2 and 3 beams for detection of the body in access monitoring
- Max range 3,5 m models TRX (2 m TRX G)
- Optoelectronic Muting sensors with 4 parallel beams.

MT TRX V with longer built-in muting arms available for high-speed conveyors.



ML, ML TRX and MT, MT TRX models are quick and easy to install. Also, they are complying with regulatory requirements on Muting sensor geometry and all other safety-related parameters, as per IEC TS 62046 and other current standards.

JANUS

JANUS MM TRX [NEW PRODUCT]

Janus MM TRX is a modular system which permits to add the pre-wired muting arms to the light curtain column in order to get either a ML TRX (one way) or a MT TRX (entry/exit) model with a few simple steps.

SL TRX and ST TRX are the pre-wired muting arms and can be ordered separately.

Janus MM TRX can also be used with external Muting sensors, with 2 or 4 sensors logic.

- Muting logics for models MM TRX are one-way (only exit), together with SL TRX, and two-way (entry/exit) together with SL TRX and ST TRX
- Max range 6 m (3,5 m when fitted with SL TRX and ST TRX).



JANUS J, JANUS J TRX, JANUS J TRX L

These models, without Muting function, have the same dimensional and electrical features of M versions with Muting.

They include:

- Janus J, 2 - 3 - 4 beams
- Janus J Long Range, 60 m, models with 2 - 3 - 4 beams and models with 40 mm resolution and protected height range 610 to 1210 mm
- Janus J TRX and J TRXL with 2 - 3 - 4 beams, consist of one active emitter/receiver element and one retro-reflecting passive element which does not need electrical connections.

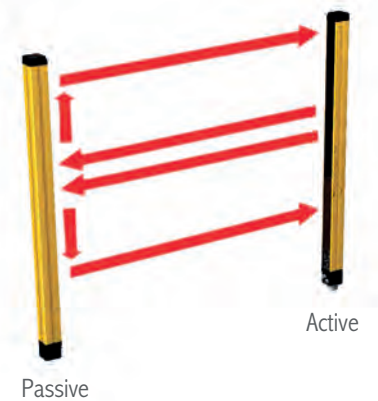

JANUS J LRH M12 [NEW PRODUCT]

Janus J LRH M12 is an extra long range model that can work up to 80 meters.

Also available with integrated laser pointer to aid the light grids alignment (J LRH M12 ILP).

For several sides protection with total distance of over 40 m, in order to facilitate the alignment it is recommended the use of the floor mounting columns FMC-SB, featuring independent adjustable mirrors (see the accessories page).

- 2 - 3 - 4 beams for detection of the body in access monitoring
- Max range up to 80 meters
- M12 5-pole connector for the emitter and M12 8-pole connector for the receiver.

JANUS MJB Connection Box for JANUS Light grids

Connection boxes Janus MJB are accessory devices designed for quick, reliable connection of Janus light grids and to ensure that major operating controls needed for operation are available in the guarded area.

- Illuminated Restart pushbutton with green led for safety output status signaling
- Key selector switch for Override function
- Muting-on indicator light
- Dip-switch for light grid functions configuration
- 2 guided-contacts safety relays operated and controlled by the light grid
- Versions without restart and override controls for connection to Janus J light grids without Muting



Please contact Reer for technical support about the connection of Janus light grids to the most common safety buses

EOS2

EOS2 is a compact Type 2 light curtain with competitive performance and innovative features.

Its features include:

- Minimal cross section - 28 x 30 mm.
- No blind area on one side:
position of first beam ensures that the sensitive area extends to end of the light curtain.
- The solution with two L-mounted light curtains, e.g. Master-Slave, maintains 40 mm resolution in corner (models with resolution 30 and 40 mm).
- Minimal blind area on connector side.
- Easy connection and installation thanks to the M12 connectors and the use of unshielded cables up to 100 m.
- Integrated safety functions, including self-monitoring of static outputs, control of external contactors (EDM) and automatic/manual selectable Restart.
- Built-in auto-test function, every 0.5 sec.
- Exceptional mechanical and electrical robustness are the result of extensive experience gained hands-on with all kinds of applications.
- Operating temperature range -10 to 55 °C.
- Protection rate: to IP 65 and IP 67 at the same time
High resistance to infiltration by dust and liquids in a highly compact light curtain.
- Models Master/Slave for cascade connection of two or three light curtains.
- 2 safety PNP static outputs.

Special versions with IP 69K watertight enclosure (WTF and WTHF), also suitable for Food & Beverage industry, available.

Models in conformity with the “ATEX Directive” 94/9/CE - Dust Zone 22 - Gas Zone 2 available on request.

EOS2 light curtains may be connected to the dedicated safety interfaces series AD SR, or directly to contactors actuated and controlled by the light curtain, or to MOSAIC or to suitable commercial safety modules or safety PLCs.

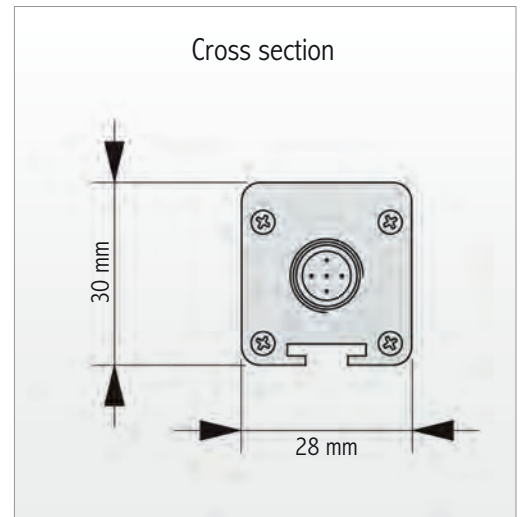
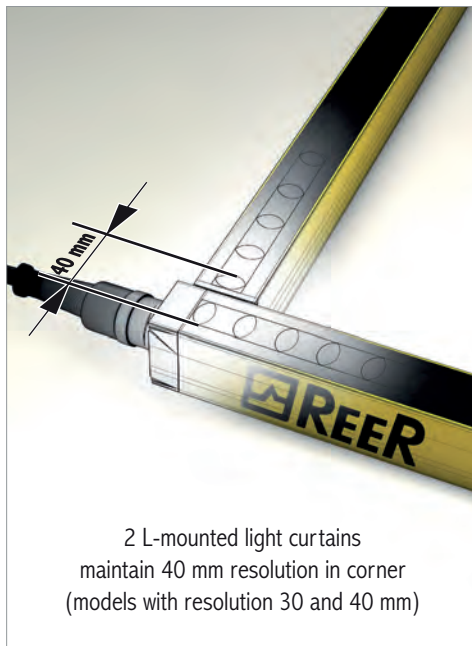

Safety level:
TYPE 2
SIL 2 – SILCL 2 PL d – Cat. 2



THE EOS2 RANGE

EOS2 A

- Protected height range 160 to 1510 mm
- 5 types of detection:
 - Resolution 30 - 40 mm for hand detection
 - Resolution 50 - 90 mm for detection of the body in a dangerous area
 - 2 - 3 - 4 beams for detection of the body in access monitoring
- Max range 12 m
- 2 safety static outputs PNP with auto-test protected against short circuits and overloads
- Automatic Start/Restart
- M12, 5-pole connectors

The ideal light curtain for straightforward interfacing with safety modules or safety PLCs.

EOS2 X

- Protected height range 160 to 1510 mm
- 5 types of detection:
 - Resolution 30 - 40 mm for hand detection
 - Resolution 50 - 90 mm for detection of the body in a dangerous area
 - 2 - 3 - 4 beams for detection of the body in access monitoring
- Max range 12 m
- M12, 5-pole connector for emitter and M12, 8-pole for receiver
- Integrated, selectable manual or automatic Start/Restart
- Feedback input for external relay monitoring (EDM)
- Master and Slave models for series connection of two or three light curtains regardless of height or resolution.

An effective light curtain for directly controlling and monitoring machine circuits with no need of external safety modules.

Master/Slave models are also ideal for series connection of several light curtains and combined detection of hand and body or the protection of two different sides of a machine.

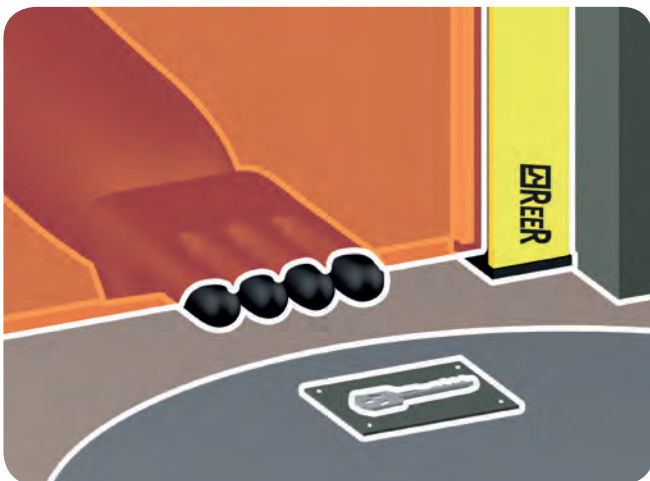

The protected area extends until the light curtain end maintaining the resolution



The resolution is maintained (up to 40 mm) in the junction between the 2 protected areas

VISION

Type 2 safety light curtains offering the following main features:

- Easy connection and installation thanks to the M12 connectors and the use of unshielded cables up to 100 m.
- Built-in main safety functions.
- 2 safety PNP static outputs.
- Built-in auto-test function, every 0.5 sec.
- Models Master/Slave for cascade connection of two light curtains.
- Models with 2, 3 and 4 beams Long Range, max 60 m.
- Built-in Muting function for models MXL.
- Built-in Muting sensors for models MXL L and MXL T.
- IP 65 protection rate.
- Operating temperature range: 0 to 55 °C.
- Cross section 35 x 45 mm.

Vision light curtains may be connected to the dedicated safety interfaces series AD SR, or directly to contactors actuated and controlled by the light curtain, or to MOSAIC, or to suitable commercial safety modules or safety PLCs.



Safety level:

TYPE 2

SIL 2 – SILCL 2
PL d – Cat. 2



THE VISION RANGE

VISION V

- Protected height range 160 to 1810 mm
- 6 types of detection:
 - Resolution 20 - 30 - 40 mm for hand detection.
 - Resolution 50 - 90 mm for detection of the body in a dangerous area
 - 2 - 3 - 4 beams for detection of the body in access monitoring
- Max range 16 m for models VH and 6 m for models VL
- M12, 5-pole connectors
- Automatic Start/Restart.

The ideal light curtain for straightforward interfacing with safety modules or safety PLCs.

VISION VX

- Protected height range 160 to 1810 mm
- 6 types of detection:
 - Resolution 20 – 30 – 40 mm for hand detection
 - Resolution 50 – 90 mm for detection of the body in a dangerous area
 - 2 - 3 - 4 beams for detection of the body in access monitoring
- Max range 18 m
- M12, 5-pole connector for emitter and M12, 8-pole for receiver
- Integrated, selectable manual or automatic Start/Restart
- Feedback input for external relay monitoring (EDM)
- Master and Slave models for series connection of two light curtains regardless of height or resolution.

An effective light curtain for directly controlling and monitoring machine circuits with no need of external safety modules.

Master/Slave models are ideal for series connection of two light curtains and combined detection of hand and body or the protection of two different sides of a machine.

VISION VX LR Long Range

- 2 - 3 - 4 beams for detection of the body in access monitoring
- Max range 60 m
- M12, 5-pole connector for emitter and M12, 8-pole for receiver
- Integrated, selectable manual or automatic Start/Restart
- Feedback input for external relay monitoring (EDM).

The ideal light curtain for protection applications with a high range, also on several sides using deflection mirrors.

VISION VXL

- Protected height range 160 to 1810 mm for models with resolution 40 mm and 160 to 1210 mm for models with resolution 30 mm
- 3 types of detection:
 - Resolution 30 - 40 mm for hand detection
 - 2 - 3 - 4 beams for detection of the body in access monitoring
- Max range 8 m
- M12, 5-pole connector for emitter and M12, 8-pole for receiver
- Integrated, selectable manual or automatic Start/Restart
- Feedback input for external relay monitoring (EDM).

Vision VXL meets the requirements of most applications and is highly cost effective.

VISION MXL with built-in Muting function

The range includes:

- Vision MXL, with external Muting sensor connectivity (any type)
- Vision MXL L and Vision MXL T with adjustable horizontal arm system and built-in photoelectric Muting sensors, prewired and prealigned.

Main features:

- Integrated, selectable manual or automatic Start/Restart
- Feedback input for external relays monitoring (EDM)
- Integrated Override with 2 selectable operating modes
- Muting Time-out 30 sec, 90 min or infinite
- Muting enable input
- M12 and M16 connectors.

Models Vision MXL offer an effective, low-cost solution for the most common palletizer applications.



VISION

VISION MXL, MXL U

- Light curtain connection for external Muting sensors of any type through main connector
- Muting logics, two-way entry/exit (2 sensors) for models MXL
- Muting logics, mono-directional, exit only (2 sensors) for models MXL U
- Protected height range 310 to 1810 mm for resolution 40 mm (310 to 1210 mm for resolution 30 mm)
- 3 types of detection:
 - Resolution 30 - 40 mm for hand detection
 - 2 - 3 - 4 beams for detection of the body in access monitoring
- Max range 8 m.



VISION MXL L

MXL L has an original 2-horizontal arms system – one for the Emitter and one for the Receiver – with built-in Muting photoelectric sensors, prewired and prealigned.

- One-way Muting logics, exit only
- 2 and 3 beams for detection of the body in access monitoring
- Max range 2.5 m
- Optoelectronic Muting sensors with 2 crossed beams.



VISION MXL T

MXL T has an original 4-horizontal arms system – 2 for the Emitter and 2 for the Receiver – with built-in Muting photoelectric sensors, prewired and prealigned.

- Two-way Muting logics, entry/exit
- 2 and 3 beams for detection of the body in access monitoring
- Max range 2.5 m
- Optoelectronic Muting sensors with 2 crossed beams.



MXJB Connection Box for Light curtains with Muting

Connection boxes MXJB are accessory devices designed for quick, reliable connection of Vision MXL light curtains and to ensure that major operating controls needed for operation are available in the guarded area.

- Restart pushbutton
- Key selector switch for Override control function
- Muting-on indicator light
- Dip-switch for light curtain functions configuration
- 2 guided-contacts safety relays operated and controlled by the light curtain



NEW PRODUCT

MAGNUS

MG S - RECTANGULAR COMPACT HOUSING

- Compact and robust thermoplastic enclosure (PBT): 22 mm fixing
- IP67 rating
- Operating temperature -25 to 75°C
- Coded magnetic operation – Tamper resistant
- Switching distance: 3 - 10 mm
- Sensor with 4 wires: 2 NO contacts
- M8 4-pole connector
- Can be connected to MOSAIC safety configurable controller (PL e) or to the dedicated safety control unit MG d1 (PL d)

**MG B - RECTANGULAR HOUSING**

- Robust thermoplastic enclosure (PBT): 78 mm fixing
- IP67 rating
- Operating temperature -25 to 75°C
- Coded magnetic operation – Tamper resistant
- Switching distance 4 - 16 mm; 7 - 18 mm with magnet MG B M+
- Sensor with 4 wires: 2 NO contacts
- M8 4-pole connector
- Can be connected to MOSAIC safety configurable controller (PL e) or to the dedicated safety control unit MG d1 (PL d)

**MG M - M30 HOUSING**

- Robust cylindrical thermoplastic enclosure (PBT): 30 mm diameter
- IP67 rating
- Operating temperature -25 to 75°C
- Coded magnetic operation – Tamper resistant
- Switching distance 4 - 16 mm; 7 - 20 mm with magnet MG M M+
- Sensor with 4 wires: 2 NO contacts
- M8 4-pole connector
- Can be connected to MOSAIC safety configurable controller (PL e) or to the dedicated safety control unit MG d1 (PL d)

**MG d1 - SAFETY CONTROL UNIT**

- Max Safety Level: PL d – SIL2 – Cat. 3
- Can control up to 8 magnetic safety switches in series
- Spring terminals
- 2 NO safety relay outputs, 3 A
- 94 mm x 75 mm x 25 mm

Safety level:

PL d**PL d – SIL 2 – Cat. 3**

Magnus magnetic switches together with Mosaic comprise a PL e certified system according to ISO 13849-1.

Certified by



Safety level:

PL e**PL e – SIL 3 – Cat. 4**

MOSAIC

MOSAIC is the new modular and configurable safety controller of Reer.

This new safety device is capable of monitoring several safety sensors and commands at the same time such as safety light curtains, safety photocells, emergency stops, safety mats, magnetic or mechanical switches, two-hand controls, etc.

Thanks to MOSAIC's modular and expandable structure, it is possible to adapt its I/O configuration and functionality to the demands of many different applications. This makes MOSAIC a highly versatile and flexible safety controller.

MOSAIC has solid state and/or relay outputs. They can be instantaneous or delayed.



Mosaic is certified to the highest safety levels established by industrial safety standards: SIL 3, SILCL 3, PL e, Cat. 4.

Main system features

- Compact design: single module dimensions 22.5 x 99 x 114.5 mm
- Removable terminal blocks, screw contacts
- Can be used with the main safety sensors and commands
- Easy, intuitive graphic configuration software (MSD - Mosaic Safety Designer) provided with the M1 at no extra cost
- Wide range of software-configurable safety functions and logical operators
- Removable memory card for configuration data storage (MCM - Mosaic Configuration Memory)
- Communication between units on proprietary high-speed bus (MSC - Mosaic Safety Communication)
- Max. 14 expansion units in addition to the M1 Master, excluding relay modules
- Max. 128 inputs and 16 OSSD pairs
- MSC bus transfer up to 100 m through I/O remote expansion units
- Digital safety inputs, programmable individually or in pairs, with the possibility of monitoring via dedicated output signals
- Possibility of programming filters and delays for each single input
- Possibility of programming output activation and de-activation delays
- Possibility of independent control of pairs of outputs
- Programmable diagnostic output signals
- Simple diagnostics via front led signalling, configuration software and bus expansion modules

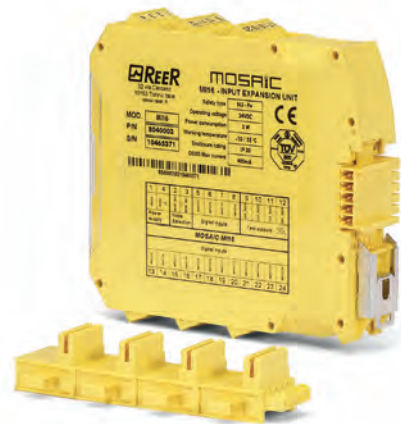

MSC Mosaic Safety Communication



Safety level:

SIL 3

SIL 3 – SILCL 3
PL e – Cat. 4

Main unit and expansion units features

- M1 stand alone main unit:
 - 8 safety inputs, 2 OSSD pairs - 400 mA output current - with separate EDM and Start/Restart, 4 test outputs and 2 programmable status outputs
 - configurable via PC through USB interface
 - MCM (Mosaic Configuration Memory card) slot for program storage
- MI8Q2 expansion unit:
 - 8 safety inputs, 2 OSSD pairs - 400 mA output current - with separate EDM and Start/Restart, 4 test outputs and 2 programmable status outputs
- MI8 and MI16 expansion units:
 - 8 and 16 safety inputs, 4 test outputs
- MI12T8 expansion unit:
 - 12 safety inputs, 8 test outputs - ideal for 4 wires safety mats and safety edges (can control up to 4 devices)
- MO2 and MO4 expansion units:
 - 2 and 4 OSSD pairs - 400 mA output current - with separate EDM and Start/Restart, 2/4 programmable status outputs
- MR2 and MR4 relay units:
 - 2 and 4 safety relays with 2 NO + 1 NC 6 A, 250 Vac guided contacts
- MB expansion units for the connection to the most common industrial Field-bus systems:
 - MBP-PROFIBUS DP, MBD-DeviceNet, MBC-CANopen, MBEI-Ethernet IP, MBEC-EtherCAT, MBEP-PROFINET, MBU (Universal Serial Bus).
- MCT Mosaic MSC-Bus transfer, up to 100 m connection length.

**Mosaic Safety Designer**

Mosaic Safety Designer (MSD) software is a user-friendly configuration tool which makes the programming of MOSAIC possible in just a few simple steps. By clicking on the functional icons it is easy to 'Drag&Drop' and configure any safety functions.

Thanks to an accurate functional test incorporated into the Mosaic Safety Designer (MSD) software, configuration errors are detected immediately. This also helps to guarantee that configuration errors cannot lead to an unsafe situation and valuable time is not lost during the commissioning of the machine.

In addition, the multi-level password management of Mosaic Safety Designer (MSD) gives further security against non-authorized access to the configuration software.

Through the MONITOR I/O feature it is possible to perform a real time monitoring of the I/Os status and the diagnostic of a working Mosaic system.

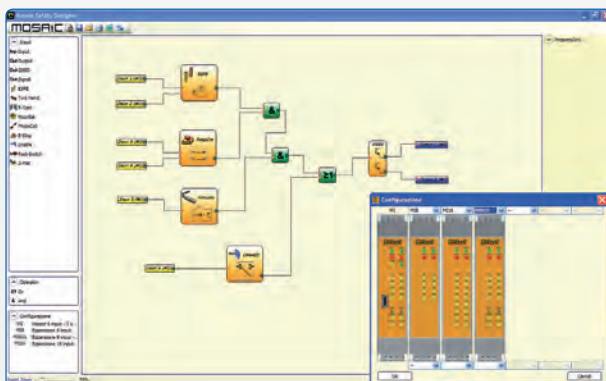
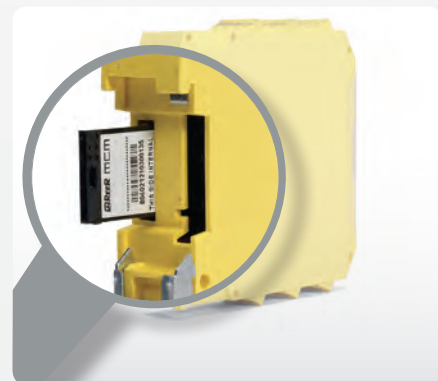
**MSD** Mosaic Safety Designer**MCM** Mosaic Configuration Memory Chip

SAFETY INTERFACES AND RELAYS

AD SR1

Interface module between the safety light curtains EOS4 A, EOS2 A, Admiral AD, Admiral AX BK, Vision V and the machine control circuits.

With guided-contact safety relays, 2 NO contacts and PNP output for relay status signaling.

- Start/Restart interlock
- EDM Feedback input for extra external contactors monitoring.



Safety level: **TYPE 4**

SIL 3 – SILCL 3 – PL e – Cat.4

AD SRM

Interface module between the safety light curtains EOS4, EOS2, Admiral, Vision, the safety laser PHARO and the machine control circuits, with 2-sensor logic integrated Muting.

With guided contact safety relays, 2 NO contacts and PNP output for relay status signaling.

- Start/Restart interlock
- EDM Feedback input for extra external contactors monitoring
- Muting Timeout selectable, 30 sec, 90 min or infinite
- Integrated Override with selectable 2-mode operation
- Muting Enable input.



Safety level: **TYPE 4**

SIL 3 – SILCL 3 – PL e – Cat.4

AD SRO, AD SROA

Interface relay modules for safety light curtains with feedback input for EDM, such as EOS4 X, Admiral AX, EOS2 X, Vision VX/VXL/MXL and Janus.

With guided-contact safety relays, 2 NO + 1 NC (AD SRO) or 2 NO contacts (AD SROA).

Additional NC contact line for the monitoring by light curtain (EDM).



SAFETY BUS INTERFACE

Please contact Reer for technical support about the connection of EOS4 A, Admiral AD, EOS2 A and Vision V safety light curtains to the most common safety buses.



Safety level: **TYPE 4**

SIL 3 – SILCL 3 – PL e – Cat.4

SAFETY INTERFACES AND RELAYS

AD SRT

Safety relays for two-hand control.

With 2 NO + 1 NC guided-contact safety relays.

EDM Feedback input for external contactors monitoring.

The AD SRT can be used up to Cat. 4, PL e.

It is certified as Type III C according to the EN 574 standard and monitors the simultaneity between the two inputs (< 0.5 sec).



Safety level: **CAT. 4**

PL e – Cat. 4 – Type III C (EN 574)

AD SRE4, AD SRE4C

Safety relays for monitoring emergency stop buttons, safety switches.

With 3 NO + 1 NC guided-contact safety relays.

- The Start/Restart can be either Automatic/Manual with the AD SRE4 or Manual Monitored with the AD SRE4C.
- EDM Feedback input for external contactors monitoring.

Both models can be used up to safety category 4, PL e according to EN ISO 13849-1



Safety level: **CAT. 4**

PL e – Cat. 4

AD SRE3, AD SRE3C

Safety relays for monitoring emergency stop buttons, safety switches.

With 2 NO + 1 NC guided-contact safety relays.

- The Start/Restart can be either Automatic/Manual with the AD SRE3 or Manual Monitored with the AD SRE3C.
- EDM Feedback input for external contactors monitoring.

Both models can be used up to safety category 3, PL d according to EN ISO 13849-1.



Safety level: **CAT. 3**

PL d – Cat. 3

ILION, ULISSE, AU SX, AU SXM

ILION

Type 2 safety photocell with cylindrical M18 metal body and M12 connector.

Ilion may be combined with the control units AU SX or AU SXM with Muting thus forming a protection system including 1, 2, 3 or 4 photocells.

The ILION range consists of:

IL 10, range 8 m
IL 20, range 20 m.

IP 67 protection rate.
Connection length (between sensors and control unit) max 50 m.

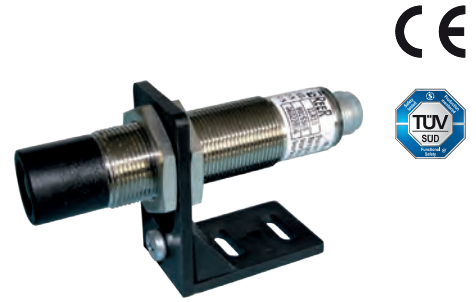

IL FB bracket allows horizontal and vertical adjustment of photocell optical axis

ULISSE

Type 2 safety photocell with metal body and M8 connector.

Ulisse may be combined with the control units AU SX or AU SXM with Muting thus forming a protection system including 1, 2, 3 or 4 photocells.

Anodized aluminum housing and glass lenses (free from dust accumulation due to static electricity).

UPC range 6 m.

IP 65 protection rate.
Connection length (between sensors and control unit) max 50 m.
Ideal for protection of weaving machines and any other application involving high mechanical stress or limited space.



AU SX

Control unit for safety photocells ILION and ULISSE, which can be combined to form a Type 2 safety system.

Up to 4 photocells may be connected.

With guided-contact safety relays, 2 NO contacts and PNP output for status signaling.

Start/Restart interlock.

EDM Feedback input for external contactors monitoring.

AU SXM with muting function

In addition to specifications of model AU SX, this unit is equipped with integrated Muting functions:

- 2-sensor Muting logics
- Muting Timeout selectable, 30 sec, 90 min or infinite
- Integrated Override with selectable 2-mode operation
- Muting Enable input.

Only the combined use of ILION or ULISSE photocells with AU SX or AU SXM control units provides the specified safety level.



Safety level: **TYPE 2**

SIL 2 – SILCL 2 – PL d – Cat. 2



PHARO

Safety laser scanner PHARO is an optoelectronic device for accident prevention creating programmable protected horizontal or vertical areas of variable shape without the need of using a separate reflector or a receiver.

The device does not need an external control unit as all safety functions are built-in.

PHARO has a Configuration Memory Module built into the pull-out connector, where data on protected areas and programmed operational parameters are stored. This module permits replacement of a faulty sensor with a new device, the configuration remaining unchanged and without possibility of error.

PHARO can create two safety zones of 4 meter max radius and two associated separately programmable pre-alarm areas:

Main features:

- Scan angle: 190°
- Safety area: 4 m radius
- Resolution configurable from 30 to 150 mm: from hand detection to access monitoring
- 2 safety PNP static outputs
- Comprehensive diagnostics through display and remote serial output
- Start/Restart interlock, integrated, selectable
- Feedback input for external relay monitoring (EDM)
- IP 65 protection rate
- Operating temperature range: -10 to 50 °C.

Configuration software through serial port RS232.
Configuration Memory Module for easy re-installation.

PHARO Laser scanner may be connected to the dedicated safety interfaces series AD SR, or directly to contactors actuated and controlled by the Laser Scanner, or to Mosaic or to suitable commercial safety modules or safety PLCs.



Safety level:

TYPE 3

**SIL 2 – SILCL 2
PL d – Cat. 3**

METRON

Photoelectric light curtains for industrial and civil applications requiring detection, measurement and identification of objects.

METRON will provide information for:

- Detecting objects
- Counting items
- Defining position
- Identifying shape or outline
- Measuring dimensions.

For programming models A and B each light curtain is provided with PC-compatible configuration Software Metronconf, with practical graphic interface.

Main features:

- Monitored height 140 to 2525 mm
- Beam spacing available: 5-10-25-30-50-75 mm
- Max range - 2 m for models with 5 mm center distance
 - 6 m for models with 25-50-75 mm center distance
 - 16 m for models with 10-30 mm center distance
- IP 65 protection rate
- Operating temperature range: 0 to 55 °C
- Cross section 35 x 45 mm.

Special versions with watertight enclosure rate IP 67 (WT and WTH) available on request.

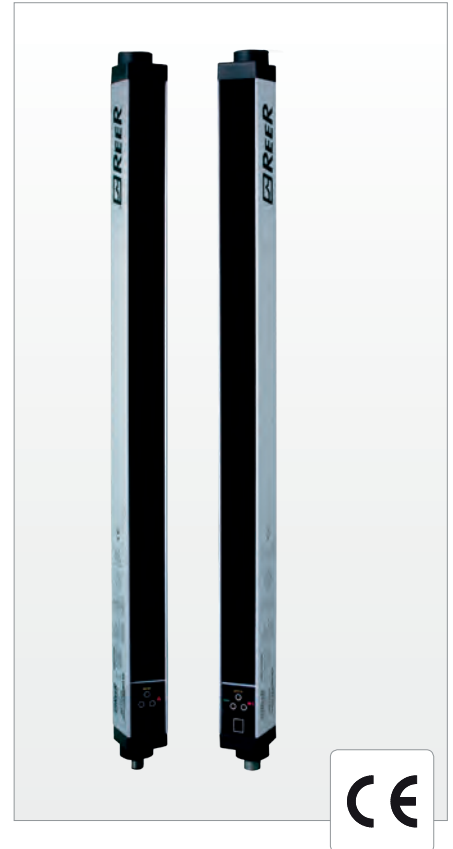

THE METRON RANGE

METRON A

4 static outputs 0/24V with programmable functionality through Metronconf Software.

M12, 8-pole connector on emitter, M16, 12-pole on receiver.

PC-programmable through interface RS232 (with M8, 3-pole connector on receiver).

Ideal solution for obtaining simple on/off data upon occurrence of programmed conditions.

Ideal for identification of objects, quality control, detection of dimensional limits.

METRON B

Serial line RS-485 + 2 static outputs 0/24V with programmable functionality through Metronconf Software.

M12, 8-pole connector on emitter, M16, 12-pole on receiver.

PC-programmable through interface RS232 (with M8, 3-pole connector on receiver).

Solution providing data on the status of each beam through serial line RS 485 and, through 2 static outputs, further on/off data upon occurrence of programmed conditions.

Ideal for dimensional measurements, detection of outline and position of objects.

METRON C

2 static outputs, 0/24V antivalent, no need of programming.

M12, 5-pole connector, on emitter and receiver.

Ideal solution for obtaining simple on/off data on status of guarded area.

Ideal for counting and detection of object present/absent in controlled field.

EXAMPLES OF APPLICATIONS

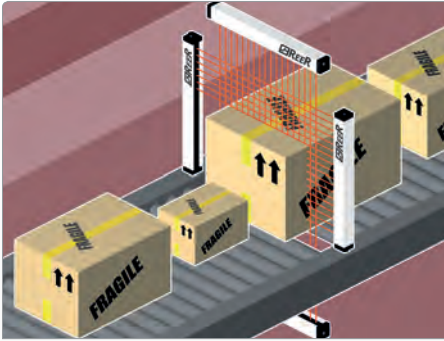

Two-dimensional detection of objects in transit on conveyor system using 2 light curtains. Volume may be calculated using third horizontal light curtain or considering travel speed.

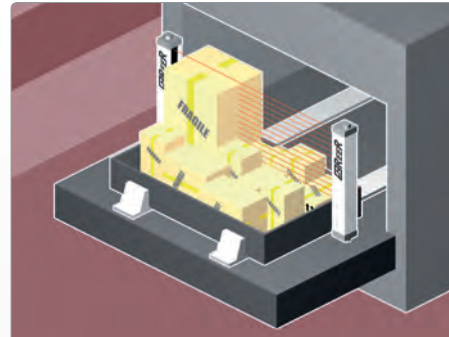

Automated warehousing: detection of max height of objects in drawers for efficient management of machine capacity.

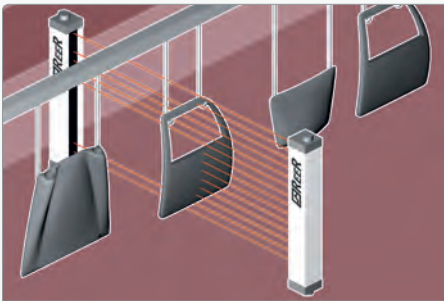

Detection of position and outline of workpieces in automated painting systems.

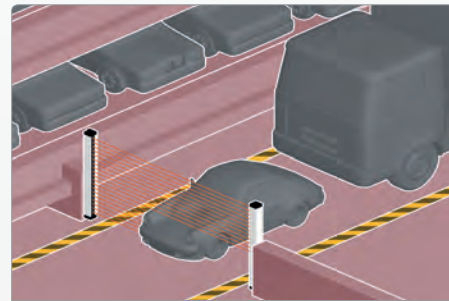

Detection overall dimensional limits of vehicle for automated parking garages.

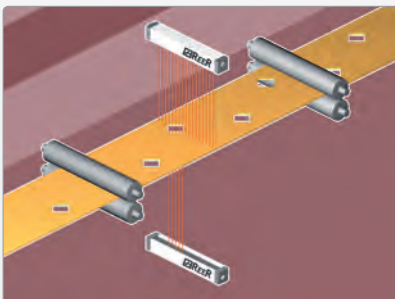

Quality control: monitoring hole present/absent/position.

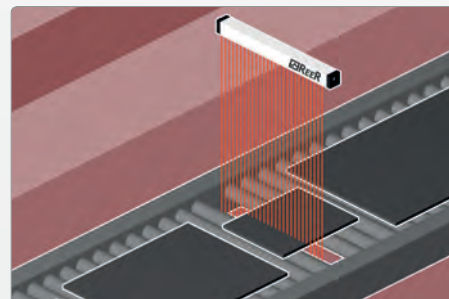

Measuring width and position of panels or slabs on roller/conveyor belt-borne material.

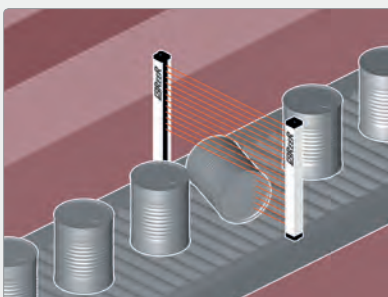

Quality control: monitoring correct positioning of objects.

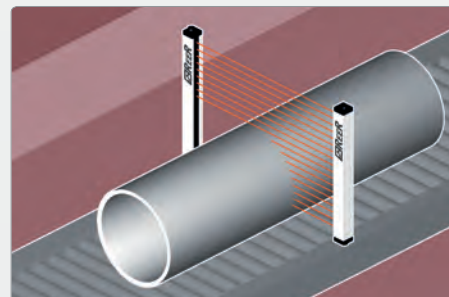

Measuring and identification of cylinders having different size.

WTF, WTHF WATERTIGHT ENCLOSURES

Watertight enclosures allow light curtains and grids to be used in harsh working environments with exposure to water and steam.

Thanks to its inert (non-toxic) components, no residuals are left when the light curtains are washed down or when they come directly in contact with food. This makes WTF and WTHF enclosures suitable for the Food & Beverage industry.

The small EOS WTF and WTHF cylindrical enclosures (only 56mm diameter) is IP 69K protection rate tested and can withstand up to 80 bar of water jets pressure at the temperature of 80 °C.

WTHF version (Heating) has a thermostatically-controlled heating system and can work down to -25° C.

Enclosure incorporates a valve to drain humidity and avoid condensation.

Available models:

EOS4 X with IP 69K WTF/WTHF ENCLOSURE

- protected height 160 to 1510 mm and 2-3-4 beams
- resolution 14 mm, max range 5 m
- resolution 30 mm and 2-3-4 beams, max range 17 m

EOS2 X with IP 69K WTF/WTHF ENCLOSURE

- protected height 160 to 1510 mm and 2-3-4 beams
- resolution 30 mm 2-3-4 beams, max range 10 m

ADMIRAL/VISION with IP 67 WT/WTH ENCLOSURE

- Resolution 30 mm, protected height 1660 mm and 1810 mm, max range 15 m
- 2 – 3 – 4 beams, long range up to 50 m
- 2 – 3 beams long range with Dual Beam Technology, max range 60 m (see page 5)

The safety light curtain/grid is delivered already enclosed into its watertight tube with a 10 meters long prewired cable and the related fastening brackets.



NEW IP69K

ACCESSORIES

FMC Floor mounting columns

Support columns for photoelectric light curtains and deflection mirrors.

- Steel base CBL (single plate) and CB (double plate) with angular and vertical axis adjustment
- Extruded aluminum column
- Integrated spirit level for monitoring vertical positioning
- Models available with pre-installed deflection mirrors ideal for perimeter protection of up to 4 sides.

FMC-SB Floor mounting columns with adjustable mirrors [NEW PRODUCT]

Models available with pre-installed and independent adjustable deflection mirrors for safety light grids with 2, 3 and 4 beams.

FMC-B12 Floor mounting columns

Permits the use with light grids with integrated Muting sensors (Janus MT and ML and Vision MXL L and MXL T).



ACCESSORIES

SP Deflection mirrors

Ideal for perimeter protection of up to 4 sides.
Angular adjustment by means of the included brackets.

**LAD Optical alignment laser**

LAD devices emit a visible red light laser beam with working range of up to 100 m.
Their use is recommended for alignment of long-range photoelectric light grids or light curtains especially if used in conjunction with deflection mirrors.

Models:

- LAD 2 for Admiral, Vision and Metron light curtains
- LAD 3 for Janus light grids
- LAD 4 for EOS light curtains.

**SAV Vibration dampers**

SAV vibration dampers are used to dampen vibrations generated by some types of machinery in order to avoid possible damage to the light curtains.

Models:

- SAV 1 and SAV 2 for Janus light curtains
- SAV 3 and SAV 4 for Admiral, Vision and Metron light curtains
- SAV 4E, SAV 8E e SAV 12E for EOS light curtains.

**SFB Swivel brackets for light curtains**

The swivel brackets are recommended for the alignment of EOS, Admiral, Vision and Metron light curtains.

They allow light curtain rotation about its longitudinal axis and adjustment of vertical and horizontal positions.





REER S.p.A.

10153 TORINO – Italy
Via Carcano, 32
Tel. +39 011 2482215
Fax +39 011 859867

www.reer.it
info@reer.it